



This is a digital copy of a book that was preserved for generations on library shelves before it was carefully scanned by Google as part of a project to make the world's books discoverable online.

It has survived long enough for the copyright to expire and the book to enter the public domain. A public domain book is one that was never subject to copyright or whose legal copyright term has expired. Whether a book is in the public domain may vary country to country. Public domain books are our gateways to the past, representing a wealth of history, culture and knowledge that's often difficult to discover.

Marks, notations and other marginalia present in the original volume will appear in this file - a reminder of this book's long journey from the publisher to a library and finally to you.

### **Usage guidelines**

Google is proud to partner with libraries to digitize public domain materials and make them widely accessible. Public domain books belong to the public and we are merely their custodians. Nevertheless, this work is expensive, so in order to keep providing this resource, we have taken steps to prevent abuse by commercial parties, including placing technical restrictions on automated querying.

We also ask that you:

- + *Make non-commercial use of the files* We designed Google Book Search for use by individuals, and we request that you use these files for personal, non-commercial purposes.
- + *Refrain from automated querying* Do not send automated queries of any sort to Google's system: If you are conducting research on machine translation, optical character recognition or other areas where access to a large amount of text is helpful, please contact us. We encourage the use of public domain materials for these purposes and may be able to help.
- + *Maintain attribution* The Google "watermark" you see on each file is essential for informing people about this project and helping them find additional materials through Google Book Search. Please do not remove it.
- + *Keep it legal* Whatever your use, remember that you are responsible for ensuring that what you are doing is legal. Do not assume that just because we believe a book is in the public domain for users in the United States, that the work is also in the public domain for users in other countries. Whether a book is still in copyright varies from country to country, and we can't offer guidance on whether any specific use of any specific book is allowed. Please do not assume that a book's appearance in Google Book Search means it can be used in any manner anywhere in the world. Copyright infringement liability can be quite severe.

### **About Google Book Search**

Google's mission is to organize the world's information and to make it universally accessible and useful. Google Book Search helps readers discover the world's books while helping authors and publishers reach new audiences. You can search through the full text of this book on the web at <http://books.google.com/>

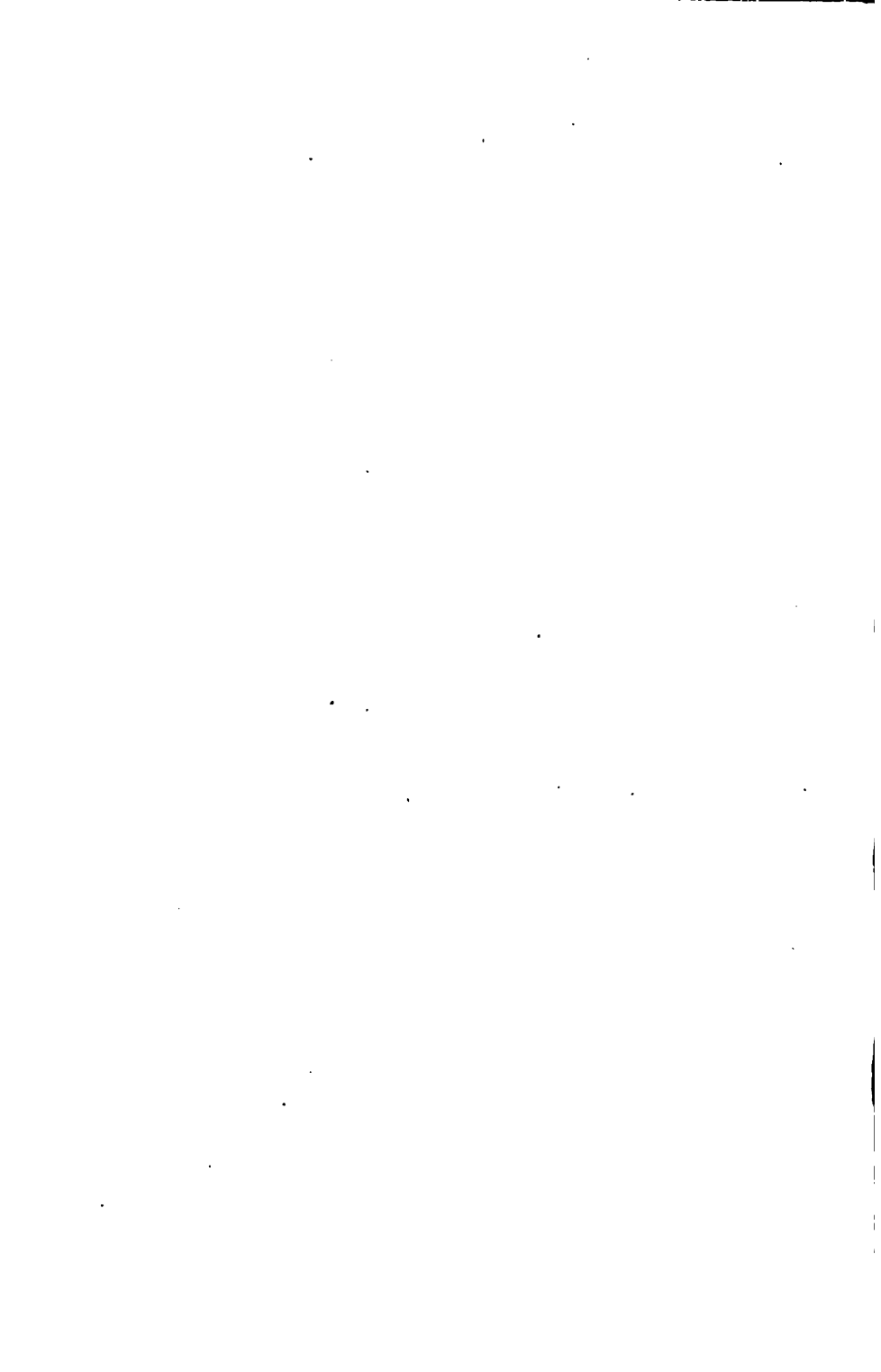

Faintly 2.13.77.65



2044 097 015 879



**Harvard College Library**

**FROM**

.....  
.....  
.....



Weller ...

Pr... 44

\$ 4.50  
\$ - . . .  
- . . .  
- . . .  
6.1

...

...

...



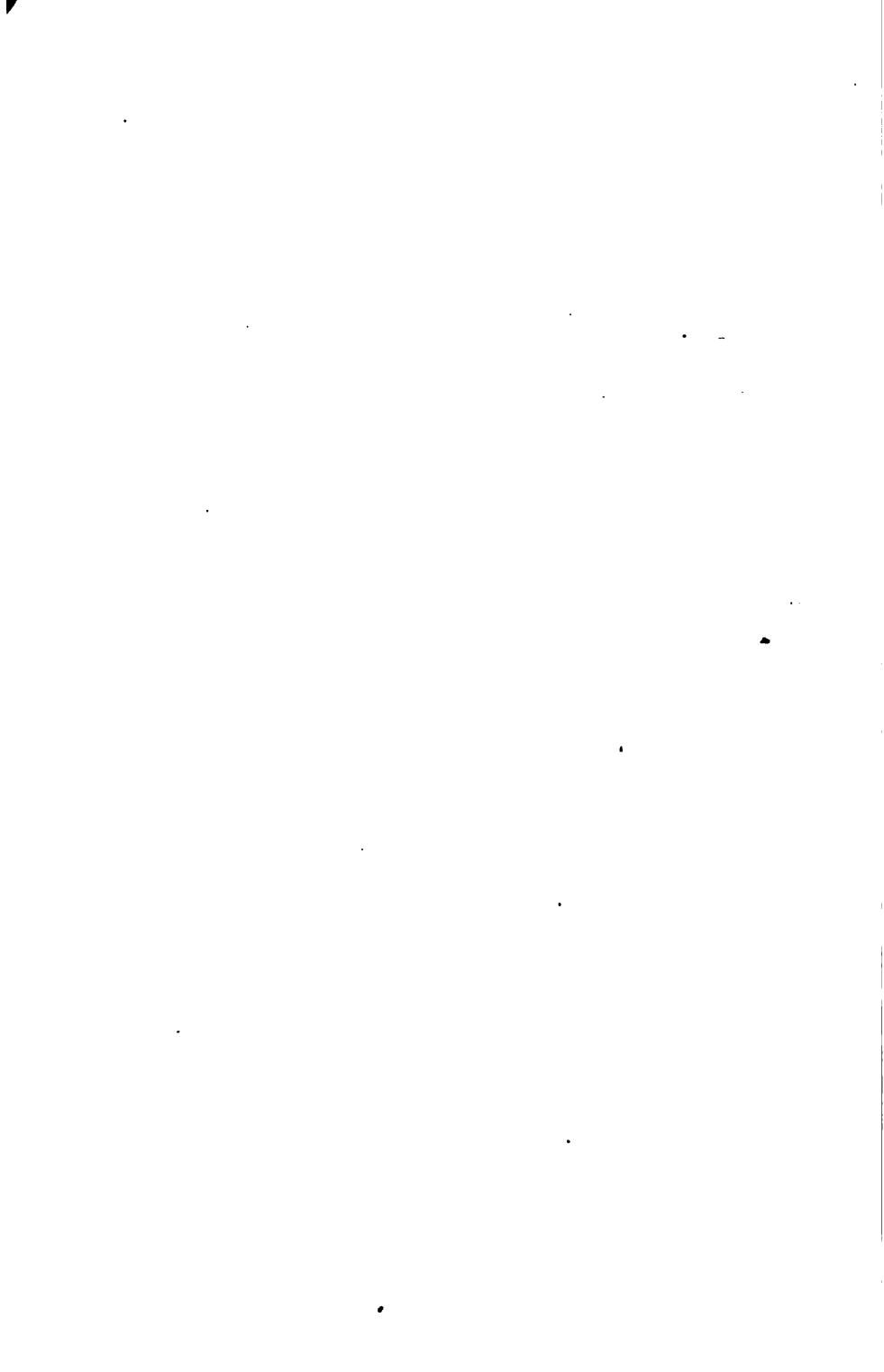











GANOT'S  
ELEMENTARY TREATISE  
ON  
PHYSICS.

Faint 218,77,665



8 2044 097 015 879



**Harvard College Library**

FROM

.....  
.....  
.....

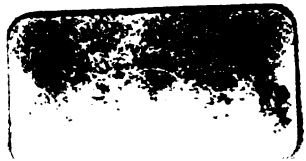

Wells Fargo

Nov. 14. 1864

\$ 10.00  
\$ - 00  
10.00  
10.00

Wells Fargo

1000 1000 1000 1000





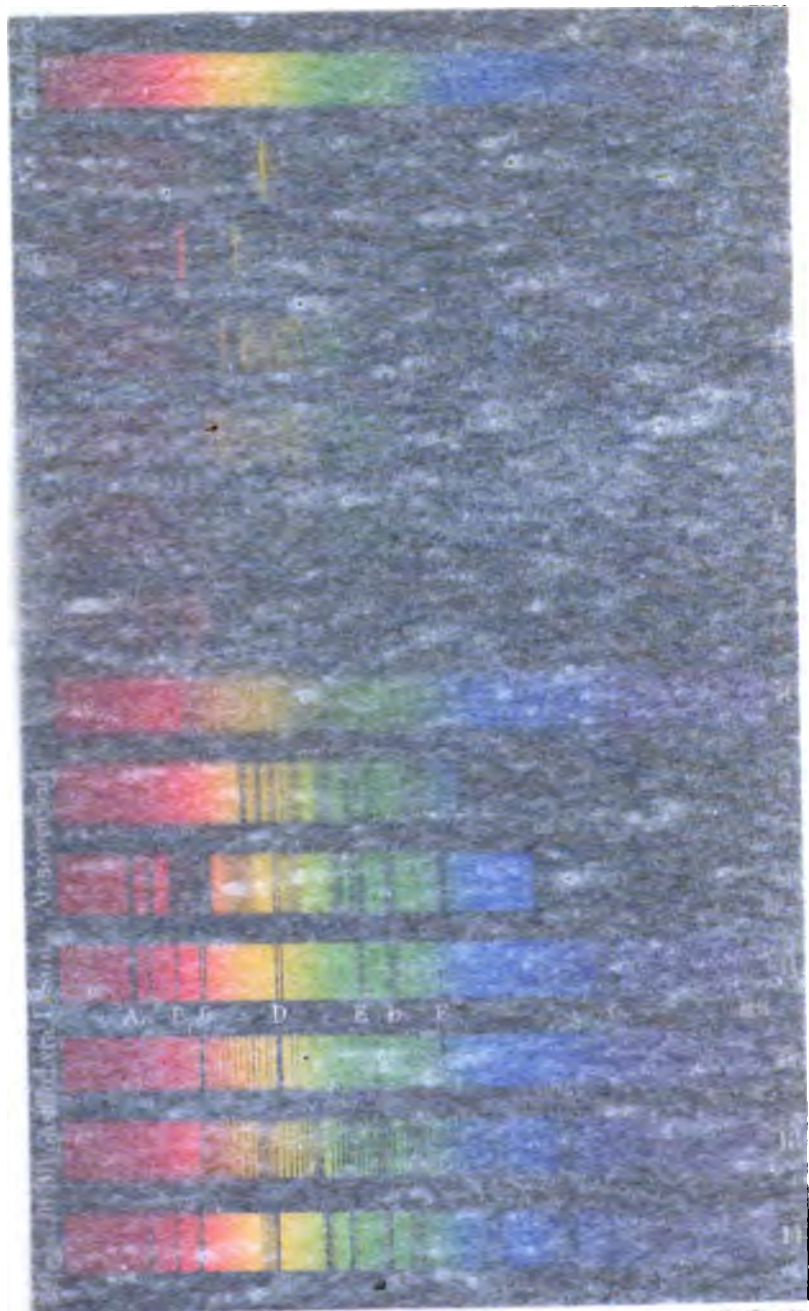

ELEMENTARY TREATISE  
ON  
PHYSICS  
EXPERIMENTAL AND APPLIED

*FOR THE USE OF COLLEGES AND SCHOOLS.*

TRANSLATED AND EDITED FROM

GANOT'S ÉLÉMENTS DE PHYSIQUE

*(with the Author's sanction)*

BY

E. ATKINSON, PH.D., F.C.S.

PROFESSOR OF EXPERIMENTAL SCIENCE, STAFF COLLEGE, SANDHURST.

*Eighth Edition, revised and enlarged.*

*ILLUSTRATED BY 4 COLOURED PLATES AND 820 WOODCUTS.*

NEW YORK:  
WILLIAM WOOD AND CO., PUBLISHERS,  
27 GREAT JONES STREET.

1877.



Exhibit 218,77,665 -



John H. ...

ADVERTISEMENT  
TO  
THE EIGHTH EDITION.

---

IN THE PRESENT EDITION no other change has been made in the body of the work than a slight alteration in the size of the page, which, with the addition of some fresh matter, has increased by about sixty pages the size of the book as it stood in the Seventh Edition. The new matter includes sixty-two additional illustrations.

The Appendix of Questions and Exercises added to the last edition was found to be not free from typographical and numerical errors. These, I hope, have been corrected or removed ; but I shall be grateful if readers of the work will point out to me any mistakes they may still find.

In consequence of some recent criticisms of this work, it seems desirable that I should point out that it is intended to be a general elementary treatise on Physics, and that while it accordingly aims at giving an account of the most important facts and general laws of all branches of Physics, an attempt to treat completely and exhaustively of any one branch would both be inconsistent with the general plan of the book and impossible within the available space. These remarks apply with special force to the section on Mechanics, which is not intended to take the place of a distinct treatise on that subject, but is rather a recapitulation or epitome of those parts of Mechanics to which most frequent reference is made in the remainder of the book, and which it is therefore of greatest importance that students of Physics should have fresh in their memory.

E. A.

STAFF COLLEGE : *August 1877.*



## EXTRACT FROM ADVERTISEMENT

TO

THE SEVENTH EDITION.

---

I HAVE added an Appendix containing a series of numerical problems and examples in Physics. This Appendix is based upon a similar one contained in the French edition of the work. But I have been able to use only a small proportion of the problems contained in that Appendix, as the interest of the solution was in most cases geometrical or algebraical. Hence I have substituted or added others, which have been so selected as to involve in the solution a knowledge of some definite physical principle.

Such an Appendix has from time to time been urged upon me by teachers and others who use the work. It will, I conceive, be more useful to those students who have not the advantage of regular instruction ; affording to them a means of personally testing their knowledge. Such a student should not aim solely at getting a result which numerically agrees with the answer. He should habituate himself to write out at length the several steps by which the result is obtained, so that he may bring clearly before himself the physical principles involved in each stage. Some of the solutions of the problems are therefore worked out at length.

E. A.

## TRANSLATOR'S PREFACE

TO

THE FIRST EDITION.

---

THE *Éléments de Physique* of Professor GANOT, of which the present work is a translation, has acquired a high reputation as an Introduction to Physical Science. In France it has passed through Nine large editions in little more than as many years, and it has been translated into German and Spanish.

This reputation it doubtless owes to the clearness and conciseness with which the principal physical laws and phenomena are explained, to its methodical arrangement, and to the excellence of its illustrations. In undertaking a translation, I was influenced by the favourable opinion which a previous use of it in teaching had enabled me to form.

I found that its principal defect consisted in its too close adaptation to the French systems of instruction, and accordingly, my chief labour, beyond that of mere translation, has been expended in making such alterations and additions as might render it more useful to the English student.

I have retained throughout the use of the centigrade thermometer, and in some cases have expressed the smaller linear measures on the metrical system. These systems are now everywhere gaining ground, and an apology is scarcely needed for an innovation which may help to familiarise the English student with their use in the perusal of the larger and more complete works on Physical Science to which this work may serve as an introduction.

E. ATKINSON.

ROYAL MILITARY COLLEGE, SANDHURST  
1863.

# CONTENTS.

## BOOK I.

### ON MATTER, FORCE, AND MOTION.

CHAPTER	PAGE
I. GENERAL NOTIONS . . . . .	I
II. GENERAL PROPERTIES OF BODIES . . . . .	3
III. ON FORCE, EQUILIBRIUM, AND MOTION . . . . .	9

## BOOK II.

### GRAVITATION AND MOLECULAR ATTRACTION.

I. GRAVITY, CENTRE OF GRAVITY, THE BALANCE . . . . .	48
II. LAWS OF FALLING BODIES. INTENSITY OF TERRESTRIAL GRAVITY. THE PENDULUM . . . . .	56
III. MOLECULAR FORCES . . . . .	66
IV. PROPERTIES PECULIAR TO SOLIDS . . . . .	68

## BOOK III.

### ON LIQUIDS.

I. HYDROSTATICS . . . . .	75
II. CAPILLARITY, ENDOSMOSE, EFFUSION, ABSORPTION, AND IMHIBITION . . . . .	101

## BOOK IV.

### ON GASES.

I. PROPERTIES OF GASES. ATMOSPHERE. BAROMETERS . . . . .	114
II. MEASUREMENT OF THE ELASTIC FORCE OF GASES . . . . .	133
III. PRESSURE ON BODIES IN AIR. BALLOONS . . . . .	143
IV. APPARATUS FOUNDED ON THE PROPERTIES OF AIR . . . . .	147

## BOOK V.

## ACOUSTICS.

CHAPTER	PAGE
I. PRODUCTION, PROPAGATION, AND REFLECTION OF SOUND . . . . .	172
II. MEASUREMENT OF THE NUMBER OF VIBRATIONS . . . . .	188
III. THE PHYSICAL THEORY OF MUSIC . . . . .	193
IV. VIBRATIONS OF STRETCHED STRINGS, AND OF COLUMNS OF AIR . . . . .	207
V. VIBRATIONS OF RODS, PLATES, AND MEMBRANES . . . . .	219
VI. GRAPHICAL METHOD OF STUDYING VIBRATORY MOTIONS . . . . .	223

## BOOK VI.

## ON HEAT.

I. PRELIMINARY IDEAS. THERMOMETERS . . . . .	233
II. EXPANSION OF SOLIDS . . . . .	245
III. EXPANSION OF LIQUIDS . . . . .	253
IV. EXPANSION AND DENSITY OF GASES . . . . .	258
V. CHANGES OF CONDITION. VAPOURS . . . . .	267
VI. HYGROMETRY . . . . .	311
VII. CONDUCTIVITY OF SOLIDS, LIQUIDS, AND GASES . . . . .	320
VIII. RADIATION OF HEAT . . . . .	326
IX. CALORIMETRY . . . . .	364
X. STEAM ENGINES . . . . .	382
XI. SOURCES OF HEAT AND COLD . . . . .	393
XII. MECHANICAL EQUIVALENT OF HEAT . . . . .	408

## BOOK VII.

## ON LIGHT.

I. TRANSMISSION, VELOCITY, AND INTENSITY OF LIGHT . . . . .	415
II. REFLECTION OF LIGHT. MIRRORS . . . . .	426
III. SINGLE REFRACTION. LENSES . . . . .	444
IV. DISPERSION AND ACHROMATISM . . . . .	466
V. OPTICAL INSTRUMENTS . . . . .	485
VI. THE EYE CONSIDERED AS AN OPTICAL INSTRUMENT . . . . .	513
VII. SOURCES OF LIGHT. PHOSPHORESCENCE . . . . .	529
VIII. DOUBLE REFRACTION. INTERFERENCE. POLARISATION . . . . .	532

BOOK VIII.

ON MAGNETISM.

CHAPTER	PAGE
I. PROPERTIES OF MAGNETS . . . . .	569
II. TERRESTRIAL MAGNETISM. COMPASSES . . . . .	575
III. LAWS OF MAGNETIC ATTRACTIONS AND REPULSIONS . . . . .	588
IV. PROCESSES OF MAGNETISATION . . . . .	594

BOOK IX.

FRICITIONAL ELECTRICITY.

I. FUNDAMENTAL PRINCIPLES . . . . .	604
II. QUANTITATIVE LAWS OF ELECTRICAL ACTION . . . . .	611
III. ACTION OF ELECTRIFIED BODIES ON BODIES IN THE NATURAL STATE. INDUCED ELECTRICITY. ELECTRICAL MACHINES . . . . .	618
IV. CONDENSATION OF ELECTRICITY . . . . .	643

BOOK X.

DYNAMICAL ELECTRICITY.

I. VOLTAIC PILE. ITS MODIFICATIONS . . . . .	673
II. DETECTION AND MEASUREMENT OF VOLTAIC CURRENTS . . . . .	693
III. EFFECTS OF THE CURRENT . . . . .	706
IV. ELECTRODYNAMICS. ATTRACTION AND REPULSION OF CURRENTS BY CURRENTS . . . . .	735
V. MAGNETISATION BY CURRENTS. ELECTROMAGNETS. ELECTRIC TELEGRAPHS . . . . .	754
VI. VOLTAIC INDUCTION . . . . .	775
VII. OPTICAL EFFECTS OF POWERFUL MAGNETS. DIAMAGNETISM . . . . .	811
VIII. THERMO-ELECTRIC CURRENT . . . . .	815
IX. DETERMINATION OF ELECTRICAL CONDUCTIVITY . . . . .	826
X. ANIMAL ELECTRICITY . . . . .	839
ELEMENTARY OUTLINES OF METEOROLOGY AND CLIMATOLOGY . . . . .	845
PROBLEMS AND EXAMPLES IN PHYSICS . . . . .	883
INDEX . . . . .	904



*Erratum.*

Page 583, line 6, *for* terrestrial *read* magnetic.

## LIST OF TABLES.

	PAGE		PAGE
ABSORBING powers . . . . .	338	HARDNESS, scale of . . . . .	74
Absorption of gases . . . . .	112		
heat by gases . . . . .	354	LATENT heat, of evaporation . . . . .	291
liquids . . . . .	348	fusion . . . . .	377
vapours . . . . .	350, 355		
various bodies . . . . .	352	MAGNETIC declination . . . . .	577
Atmosphere, composition of . . . . .	117	inclination . . . . .	583
		intensity . . . . .	586
BAROMETRIC variations . . . . .	128		
Breaking weight of substances . . . . .	73	RADIATING powers . . . . .	338, 346
Boiling point . . . . .	284, 286	Radiation of powders . . . . .	359
		Refraction, angle of double . . . . .	538
CAPILLARITY in barometers . . . . .	126	Refractive indices . . . . .	454, 455
Combustion, heat of . . . . .	400, 401	of media of eye . . . . .	515
Conducting powers of solids for . . . . .	322	Reflecting powers . . . . .	337
heat . . . . .	322		
liquids for heat . . . . .	324	SOUND, transmission of, in tubes . . . . .	178
Conductors of electricity . . . . .	606	Specific gravity of solids . . . . .	96, 97
		liquids . . . . .	98
DENSITIES of gases . . . . .	266	heat of solids and liquids, 371-373 . . . . .	375
vapours . . . . .	310	gases . . . . .	375
Density of water . . . . .	258	inductive capacities . . . . .	624
Diathermanous power . . . . .	348, 349		
Diffusion of solutions . . . . .	109	TANGENT galvanometer and volta- . . . . .	727
Diamagnetism . . . . .	815	meter, comparison between . . . . .	727
		Temperatures, various remarkable . . . . .	245
ENDOSMOTIC equivalents . . . . .	107	of different latitudes . . . . .	880
Elasticity . . . . .	70	thermal springs . . . . .	881
Electrical series . . . . .	680, 681	measurement of . . . . .	263
conductivity . . . . .	827, 835	Tension of aqueous vapour 277, 281, 282 . . . . .	282
Electricity, positive and negative . . . . .	609	vapours of liquids . . . . .	282
Electromotive force of different . . . . .	691	Thermo-electric series . . . . .	816
elements . . . . .	691		
Expansion, coefficients of solids, 248, 249 . . . . .	248, 249	UNDULATIONS, length of . . . . .	533
liquids . . . . .	256		
gases . . . . .	262	VELOCITY of sound in rocks . . . . .	179
Eye, dimensions of . . . . .	515	gases . . . . .	181
refractive indices of media of . . . . .	515	liquids . . . . .	182
		metals and . . . . .	183
FREEZING mixtures . . . . .	272	woods . . . . .	183
Fusing points of bodies . . . . .	297	Vibrations of musical scale . . . . .	194
GLAISHER'S factors . . . . .	316		
Gravity, force of, at different levels . . . . .	62		

## LIST OF PLATES.

TABLE OF SPECTRA . . . . .	<i>Frontispiece</i>
COLOURED RINGS PRODUCED BY POLARISED LIGHT IN DOUBLE REFRACT- ING CRYSTALS . . . . .	556
ISOSONIC LINES FOR THE YEAR 1860 . . . . .	579
ISOCLINIC LINES FOR THE YEAR 1860 . . . . .	583

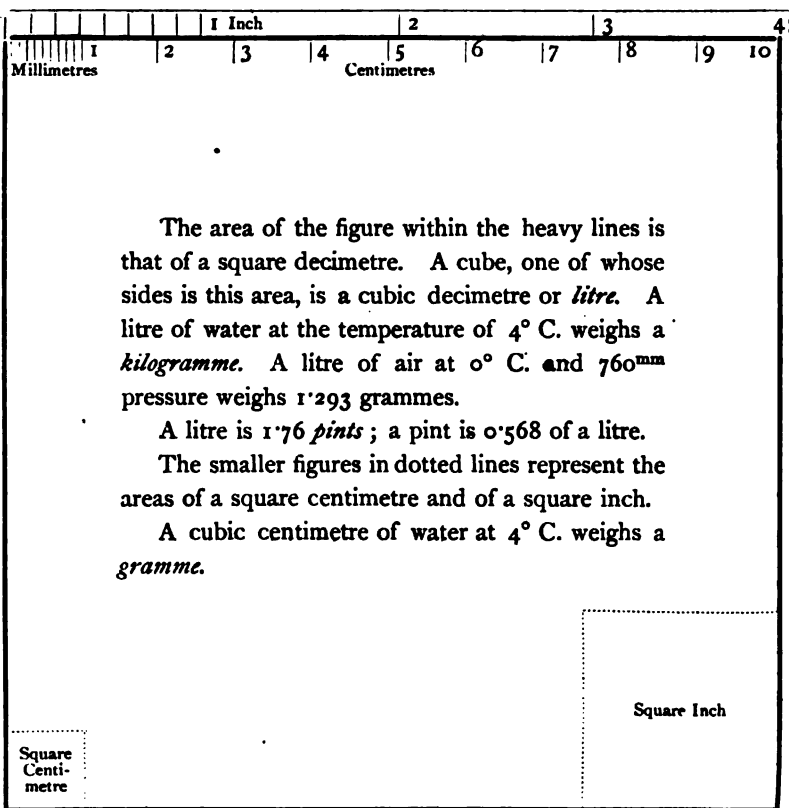

The area of the figure within the heavy lines is that of a square decimetre. A cube, one of whose sides is this area, is a cubic decimetre or *litre*. A litre of water at the temperature of  $4^{\circ}$  C. weighs a *kilogramme*. A litre of air at  $0^{\circ}$  C. and  $760^{\text{mm}}$  pressure weighs 1.293 grammes.

A litre is 1.76 *pints*; a pint is 0.568 of a litre.

The smaller figures in dotted lines represent the areas of a square centimetre and of a square inch.

A cubic centimetre of water at  $4^{\circ}$  C. weighs a *gramme*.

	Metres	Feet
Millimetre . . . . .	0.03937	0.003281
Centimetre . . . . .	0.39371	0.032819
Decimetre . . . . .	3.93708	0.328090
Metre . . . . .	39.37079	3.280899
Kilometre . . . . .	39370.70000	3280.899167

A Hectare or 10000 square metres is equal to 2.47114 acres, each of which is 43560 square feet. A kilometre is 0.6214 of a statute mile. A statute mile is 1.609 kilometres. A knot (in telegraphy) is 2029 yards or 1.1528 statute miles.

### Measures of Capacity.

	Cubic Inches	Cubic Feet
Cubic centimetre or millitre . . . . .	0.06103	1728 c. in. = 1 c. ft. 0.000035
Litre or cubic decimetre . . . . .	61.02705	0.035317
Kilolitre or cubic metre . . . . .	61027.05152	35.316581

### Measures of Weight.

	English grains	Avoirdupois pounds of 7000 grains
Milligramme . . . . .	0.01543	0.000022
Gramme . . . . .	15.43235	0.0022046
Kilogramme . . . . .	15432.34880	2.2046213

1 grain = 0.064799 gramme; 1 pound avoirdupois is 0.453593 kilogramme.

# ELEMENTARY TREATISE

ON

# PHYSICS.

---

## BOOK I.

### ON MATTER, FORCE, AND MOTION.

---

---

#### CHAPTER I.

##### GENERAL NOTIONS.

1. **Object of Physics.**—The object of *Physics* is the study of the phenomena presented to us by bodies. It should, however, be added, that changes in the nature of the body itself, such as the decomposition of one body into others, are phenomena whose study forms the more immediate object of *chemistry*.

2. **Matter.**—That which possesses the properties whose existence is revealed to us by our senses, we call *matter* or *substance*.

All substances at present known to us may be considered as chemical combinations of sixty-five *elementary* or *simple* substances. This number, however, may hereafter be diminished or increased by the discovery of some more powerful means of chemical analysis than we at present possess.

3. **Atoms, molecules.**—From various properties of bodies, we conclude that the matter of which they are formed is not perfectly continuous, but consists of an aggregate of an immense number of exceedingly small portions or *atoms* of matter. These atoms cannot be divided physically, they are retained side by side, without touching each other, being separated by distances which are great in comparison with their supposed dimensions.

A group of two or more atoms forms a *molecule*, so that a body may be considered as an aggregate of very small molecules, and these again as aggregates of still smaller atoms. The smallest masses of matter we ever obtain artificially are *particles* and not molecules or atoms. Molecules retain their position in virtue of the action of certain forces called *molecular forces*.

From considerations based upon various physical phenomena Sir W.

Thomson has calculated that in ordinary solids and liquids the average distance between contiguous molecules is less than the hundred millionth but greater than the two thousand millionth of a centimetre.

To form an idea of the degree of the size of the molecules Sir W. Thomson gives this illustration : ' Imagine a drop of rain, or a glass sphere the size of a pea, magnified to the size of the earth, the molecules in it being increased in the same proportion. The structure of the mass would then be coarser than that of a heap of fine shot, but probably not so coarse as that of a heap of cricket-balls.'

**4. Molecular state of bodies.**—With respect to the molecules of bodies three different states of aggregation present themselves.

*First, the solid state*, as observed in wood, stone, metals, etc., at the ordinary temperature. The distinctive character of this state is, that the relative positions of the molecules of the bodies is fixed and cannot be changed without the expenditure of more or less force. As a consequence, solid bodies tend to retain whatever form may have been given to them by nature or by art.

*Secondly, the liquid state*, as observed in water, alcohol, oil, etc. Here the relative position of the molecules is no longer fixed, the molecules glide past each other with the greatest ease, and the body assumes with readiness the form of any vessel in which it may be placed.

*Thirdly, the gaseous state*, as in air. In gases the mobility of the molecules is still greater than in liquids ; but the distinctive character of a gas is its incessant struggle to occupy a greater volume, or the tendency of its molecules to recede from each other.

The general term *fluid* is applied to both liquids and gases.

We shall see in the sequel that the state of a body depends upon the relations which exist between its molecular attractions and repulsions, and that for one and the same body these relations vary with the temperature. On this account most simple bodies, and many compound ones, may be made to pass successively through all the three states. Water presents the most familiar example of this. Sulphur is another instance.

**5. Physical phenomena, laws, and theories.**—Every change which can happen to a body, mere alteration of its chemical constitution being excepted, may be regarded as a *physical phenomenon*. The fall of a stone, the vibration of a string, and the sound which accompanies it, the rippling of the surface of a lake, and the freezing of water, are examples of such phenomena.

A *physical law* is the constant relation which exists between any phenomenon and its cause. As an example, we have the phenomenon of the diminution of the volume of a gas by the application of pressure ; the corresponding law has been discovered, and is expressed by saying that *the volume of a gas is inversely proportional to the pressure*.

In order to explain whole classes of phenomena, suppositions, or *hypotheses*, are made use of ; the utility and probability of a hypothesis or theory is the greater the simpler it is, and the more varied and numerous are the phenomena which are *explained* by it ; that is to say, are brought into regular causal connection among themselves and with other natural phenomena. Thus the adoption of the undulatory theory of light is justified by

the simple and unconstrained explanation it gives of all luminous phenomena, and by the connection it reveals with the phenomena of heat.

6. **Physical agents.**—In our attempts to ascend from a phenomenon to its cause, we assume the existence of *physical agents*, or *natural forces* acting upon matter; as examples of such we have *gravitation, heat, light, magnetism, and electricity*.

Since these physical agents are disclosed to us only by their effects, their intimate nature is completely unknown. In the present state of science, we cannot say whether they are properties inherent in matter, or whether they result from movements impressed on the mass of subtile and imponderable forms of matter diffused through the universe. The latter hypothesis is, however, generally admitted. This being so, it may be further asked, are there several distinct forms of imponderable matter, or are they in reality but one and the same? As the physical sciences extend their limits, the opinion tends to prevail that there is a subtile, imponderable, and eminently elastic fluid called the ether distributed through the entire universe; pervading the mass of all bodies, the densest and most opaque, as well as the lightest or the most transparent. It is also considered that the intimate particles of which matter is made up are capable of definite motions varying in character and velocity, and which can be communicated to the ether. A motion of a particular kind communicated to the ether can give rise to the phenomenon of heat; a motion of the same kind, but of greater velocity, produces light; and it may be that a motion different in form or in character is the cause of electricity. Not merely do the atoms of bodies communicate motion to the atoms of the ether, but this latter can impart it to the former. Thus the atoms of bodies are at once the sources and the recipients of the motion. All physical phenomena, referred thus to a single cause, are but transformations of motion.

## CHAPTER II.

### GENERAL PROPERTIES OF BODIES.

7. **Different kinds of properties.**—By the term *properties*, as applied to bodies, we understand the different ways in which bodies present themselves to our senses. We distinguish *general* from *specific* properties. The former are shared by all bodies, and amongst them the most important are *impenetrability, extension, divisibility, porosity, compressibility, elasticity, mobility, and inertia*.

Specific properties are such as are observed in certain bodies only, or in certain states of these bodies; such are *solidity, fluidity, tenacity, ductility, malleability, hardness, transparency, colour, etc.*

With respect to the above general properties, *impenetrability* and *extension* might, perhaps, be more aptly termed essential attributes of matter, since they suffice to define it; and that *divisibility, porosity, compressibility, and elasticity* do not apply to atoms, but only to bodies or aggregates of atoms (3).

8. **Impenetrability.**—*Impenetrability* is the property in virtue of which two portions of matter cannot at the same time occupy the same portion of

space. Thus when a stone is placed in a vessel of water the volume of the water rises by an amount depending on the volume of the stone; this method, indeed, is used to determine the bulk of irregularly shaped bodies by means of graduated measures.

Strictly speaking, this property applies only to the atoms of a body. In many phenomena bodies appear to penetrate each other; thus, the volume of a compound body is always less than the sum of the volumes of its constituents; for instance, the volume of a mixture of water and sulphuric acid, or of water and alcohol, is less than the sum of the volumes before mixture. In all these cases, however, the penetration is merely apparent, and arises from the fact that in every body there are interstices or spaces unoccupied by matter (13).

9. **Extension.**—*Extension* or *magnitude* is the property in virtue of which every body occupies a limited portion of space.

Many instruments have been invented for measuring linear extension or lengths with great precision. Two of these, the vernier and micrometer screw, on account of their great utility, deserve to be here mentioned.

10. **Vernier.**—The *vernier* forms a necessary part of all instruments where lengths or angles have to be estimated with precision; it derives its name from its inventor, a French mathematician, who died in 1637, and consists essentially of a short graduated scale, *a b*, which is made to slide

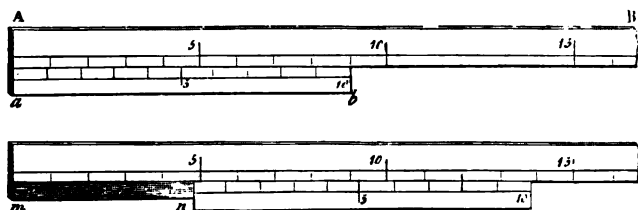

Fig. 1.

along a fixed scale, *A B*, so that the graduations of both may be compared with each other. The fixed scale, *A B*, being divided into equal parts, the whole length of the vernier, *a b*, may be taken equal to nine of those parts, and is itself divided into ten equal parts. Each of the parts of the vernier, *a b*, will then be less than a part of the scale by one tenth of the latter.

This granted, in order to measure the length of any object, *m n*, let us suppose that the latter, when placed as in the figure, has a length greater than four but less than five parts of the fixed scale. In order to determine by what fraction of a part *m n* exceeds four, one of the ends, *a*, of the vernier, *a b*, is placed in contact with one extremity of the object, *m n*, and the division on the vernier is sought which coincides with a division on the scale, *A B*. In the figure this coincidence occurs at the eighth division of the vernier, counting from the end, *n*, and indicates that the fraction to be measured is equal to  $\frac{8}{10}$ ths of a part of the scale, *A B*. In fact, each of the parts of the vernier being less than a part of the scale by  $\frac{1}{10}$ th of the latter, it is clear that on proceeding towards the left from the point of coincidence, the divisions of the vernier are respectively one, two, three, etc.

tenths behind the divisions of the scale ; so that the end,  $n$ , of the object (that is to say, the eighth division of the vernier) is  $\frac{8}{10}$ ths behind the division marked 4 on the scale ; in other words, the length of  $mn$  is equal to  $4\frac{8}{10}$ ths of the parts into which the scale A B is divided. Consequently, if the scale A B were divided into inches, the length of  $mn$  would be  $4\frac{8}{10} = 4\frac{4}{5}$  inches. The divisions on the scale remaining the same, it would be necessary to increase the length of the vernier in order to measure the length  $mn$  more accurately. For instance, if the length of the vernier were equal to nineteen of the parts on the scale, and this length were divided into twenty equal parts, the length  $mn$  could be determined to the twentieth of a part on the scale, and so on. In instruments like the theodolite, intended for measuring angles, the scale and vernier have a circular form, and the latter usually carries a magnifier, in order to determine with greater precision the coincident divisions of vernier and scale.

11. **Micrometer screw.**—Another useful little instrument for measuring small lengths with precision is the *micrometer screw*. It is used under various forms, but the principle is the same in all, and may be illustrated by a simple example. Suppose the distance between the threads of an accurately cut screw to be equal to  $\frac{1}{10}$ th of an inch, and the head of the screw to be a tolerably large circle divided into one hundred equal parts. If the screw is fixed in such a manner that it can only turn on its axis, but neither advance nor recede, and if it works in a nut held between guides which prevent it from turning, then every turn of the screw will cause the nut to advance through the tenth part of an inch. If a fixed pointer be placed before the divided circle at the head of the screw, and the latter be turned through so small an angle that only one division of the circle passes under the pointer, the hundredth part of a turn will have been given to the screw, and the nut thereby caused to advance or recede through the hundredth part of the distance between two threads—that is to say, through the  $\frac{1}{1000}$ th part of an inch. Applications of this principle to the measurement of small lengths are met with in the *spherometer*, and in the *dividing machine*, and will be readily understood when seen.

12. **Divisibility**—is the property in virtue of which a body may be separated into distinct parts.

Numerous examples may be cited of the extreme divisibility of matter. The tenth part of a grain of musk will continue for years to fill a room with its odiferous particles, and at the end of that time will scarcely be diminished in weight. Blood is composed of red, flattened globules, floating in a colourless liquid called *serum*. In man the diameter of one of these globules is less than the 3,500th part of an inch, and the drop of blood which might be suspended from the point of a needle would contain about a million of globules.

Again, the microscope has disclosed to us the existence of insects smaller even than these particles of blood ; the struggle for existence reaches even to these little creatures, for they devour still smaller ones. If blood runs in the veins of these devoured ones, how infinitesimal must be the magnitude of its component globules !

Although experiment fails to determine whether there be a limit to the divisibility of matter, many facts in chemistry, such as the invariability in



the relative weights of the elements which combine with each other, would lead us to believe that such a limit does exist. It is on this account that bodies are conceived to be composed of extremely minute and indivisible parts called *atoms* (3).

13. **Porosity.**—*Porosity* is the quality in virtue of which interstices or *pores* exist between the molecules of a body.

Two kinds of pores may be distinguished : *physical pores*, where the interstices are so small that the surrounding molecules remain within the sphere of each other's attracting or repelling forces ; and *sensible pores*, or actual cavities across which these molecular forces cannot act. The contractions and expansions resulting from variations of temperature are due to the existence of physical pores, whilst in the organic world the sensible pores are the seat of the phenomena of exhalation and absorption.

In wood, sponge, and a great number of stones—for instance, pumice stone—the sensible pores are apparent ; physical pores never are. Yet, since the volume of every body may be diminished, we conclude that all possess physical pores.

The existence of sensible pores may be shown by the following experiment :—A long glass tube, A (fig. 2), is provided with a brass cup, *m*, at the top, and a brass foot made to screw on to the plate of an air-pump. The bottom of the cup consists of a thick piece of leather. After pouring mercury into the cup so as entirely to cover the leather, the air-pump is put in action, and a partial vacuum produced within the tube. By so doing a shower of mercury is at once produced within the tube, for the atmospheric pressure on the mercury forces that liquid through the pores of the leather. In the same manner water or mercury may be forced through the pores of wood, by replacing the leather in the above experiment by a disc of wood cut perpendicular to the fibres.



Fig. 2.

When a piece of chalk is thrown into water, air-bubbles at once rise to the surface, in consequence of the air in the pores of the chalk being expelled by the water. The chalk will be found to be heavier after immersion than it was before, and from the increase of its weight the volume of its pores may be easily determined.

The porosity of gold was demonstrated by the celebrated Florentine experiment made in 1661. Some academicians at Florence, wishing to try whether water was compressible, filled a thin globe of gold with that liquid, and, after closing the orifice hermetically, they exposed the globe to pressure with a view of altering its form, knowing that any alteration in form

must be accompanied by a diminution in volume. The consequence was, that the water forced its way through the pores of the gold, and stood on the outside of the globe like dew. More than twenty years previously the same fact was demonstrated by Francis Bacon by means of a leaden sphere; the experiment has since been repeated with globes of other metals, and similar results obtained.

**14. Apparent and real volumes.**—In consequence of the porosity of bodies, it becomes necessary to distinguish between their real and apparent volumes. The *real volume* of a body is the portion of space actually occupied by the matter of which the body is composed; its *apparent volume* is the sum of its real volume and the total volume of its pores. The real volume of a body is invariable, but its apparent volume can be altered in various ways.

**15. Applications.**—The property of porosity is utilised in filters of paper, felt, stone, charcoal, etc. The pores of these substances are sufficiently large to allow liquids to pass, but small enough to arrest the passage of any substances which these liquids may hold in suspension. Again, large blocks of stone are often detached in quarries by introducing wedges of dry wood into grooves cut in the rock. These wedges being moistened, water penetrates their pores, and causes them to swell with considerable force. Dry cords, when moistened, increase in diameter and diminish in length, a property of which advantage has been taken in order to raise great weights.

**16. Compressibility.**—*Compressibility* is the property in virtue of which the volume of a body may be diminished by pressure. This property is at once a consequence and a proof of porosity.

Bodies differ greatly with respect to compressibility. The most compressible bodies are gases; by sufficient pressure they may be made to occupy ten, twenty, or even a hundred times less space than they do under ordinary circumstances. In most cases, however, there is a limit beyond which, when the pressure is increased, they become liquids.

The compressibility of solids is much less than that of gases, and is found in all degrees. Cloths, paper, cork, woods, are amongst the most compressible. Metals are so also to a great extent, as is proved by the process of coining, in which the metal receives the impression from the die. There is, in most cases, a limit beyond which, when the pressure is increased, bodies are fractured or reduced to powder.

The compressibility of liquids is so small as to have remained for a long time undetected: it may, however, be proved by experiment, as will be seen in the chapter on Hydrostatics.

**17. Elasticity.**—*Elasticity* is the property in virtue of which bodies resume their original form or volume, when the force which altered that form or volume ceases to act. Elasticity may be developed in bodies by pressure, by traction or *pulling*, flexion or *bending*, and by torsion or *twisting*. In treating of the general properties of bodies, the elasticity developed by pressure alone requires consideration; the other kinds of elasticity being peculiar to solid bodies, will be considered amongst their specific properties (arts. 89, 90, 91).

Gases and liquids are perfectly elastic; in other words, after undergoing a change in volume they regain exactly their original volume when the

pressure becomes what it originally was. Solid bodies present different degrees of elasticity, though none present the property in the same perfection as liquids and gases, and in all it varies according to the time during which the body has been exposed to pressure. Caoutchouc, ivory, glass, and marble possess considerable elasticity; lead, clay, and fats, scarcely any.

There is a limit to the elasticity of solids, beyond which they either break or are incapable of regaining their original form and volume. This is called the *limit of elasticity*. In sprains, for instance, the elasticity of the tendons has been exceeded. In gases and liquids, on the contrary, no such limit can be reached; they always regain their original volume.

If a ball of ivory, glass, or marble be allowed to fall upon a slab of polished marble, which has been previously slightly smeared with oil, it will rebound and rise to a height nearly equal to that from which it fell. On afterwards examining the ball a circular blot of oil will be found upon it, more or less extensive according to the height of the fall. From this we conclude that at the moment of the shock the ball was flattened, and that its rebound was caused by the effort to regain its original form.

18. **Mobility, motion, rest.**—*Mobility* is the property in virtue of which the position of a body in space may be changed.

Motion and rest may be either relative or absolute. By the *relative motion* or *rest* of a body we mean its change or permanence of position with respect to surrounding bodies; by its *absolute motion* or *rest* we mean the change or permanence of its position with respect to ideal fixed points in space.

Thus a passenger in a railway carriage may be in a state of relative rest with respect to the train in which he travels, but he is in a state of relative motion with respect to the objects, such as trees, houses, etc., past which the train rushes. These houses again enjoy merely a state of relative rest, for the earth itself which bears them is in a state of incessant relative motion with respect to the celestial bodies of our solar system, inasmuch as it moves at the rate of more than eighteen miles in a second. In short, absolute motion and rest are unknown to us; in nature, relative motion and rest are alone presented to our observation.

19. **Inertia.**—*Inertia* is a purely negative property of matter (26); it is the property that matter cannot of itself change its own state of motion or of rest. If a body is at rest it remains so until some force acts upon it; if it is in motion this motion can only be changed by the application of some force.

A body, when unsupported in mid-air, does not fall to the earth in virtue of any inherent property, but because it is acted upon by the force of gravity. A billiard ball gently pushed does not move more and more slowly, and finally stop, because it has any preference for a state of rest, but because its motion is impeded by the friction on the cloth on which it rolls, and by the resistance of the air. If all impeding causes were withdrawn, a body once in motion would continue to move for ever in a straight line with unchanging velocity.

20. **Application.**—Numerous phenomena may be explained by the inertia of matter. For instance, before leaping a ditch we run towards it, in

order that the motion of our bodies at the moment of leaping may add itself to the muscular effort then made.

On descending carelessly from a carriage in motion, the upper part of the body retains its motion, whilst the feet are prevented from doing so by friction against the ground; the consequence is we fall towards the moving carriage. A rider falls over the head of a horse if it suddenly stops. In striking the handle of a hammer against the ground the handle suddenly stops, but the head, striving to continue its motion, fixes itself more firmly on the handle.

By the property of inertia may also be explained the following experiments. Let a card be placed upon a tumbler, and a shilling on the card; if the edge of the card be smartly flicked with the finger the card is driven away and the coin falls into the tumbler. A gentle push with the finger will move a door on its hinges; but if a pistol bullet be fired against the door it perforates the door without moving it.

The terrible accidents on our railways are chiefly due to inertia. When the motion of the engine is suddenly arrested the carriages strive to continue the motion they had acquired, and in doing so are shattered against each other. Hammers, pestles, stampers are applications of inertia. So are also the enormous iron fly-wheels, by which the motion of steam engines is regulated.

### CHAPTER III.

#### ON FORCE, EQUILIBRIUM, AND MOTION.

**21. Measure of time.**—To obtain a proper measure of force it is necessary, as a preliminary, to define certain conceptions which are presupposed in that measure; and, in the first place, it is necessary to define the unit of time. Whenever a *second* is spoken of without qualification it is understood to be a second of *mean solar time*. The exact length of this unit is fixed by the following considerations. The instant when the sun's centre is on an observer's meridian—in other words, the instant of the *transit* of the sun's centre—can be determined with exactitude, and thus the interval which elapses between two successive transits also admits of exact determination, and is called an *apparent day*. The length of this interval differs slightly from day to day, and therefore does not serve as a convenient measure of time. Its *average* length is free from this inconvenience, and therefore serves as the required measure, and is called a *mean solar day*. The short hand of a common clock would go exactly twice round the face in a mean solar day if it went perfectly. The mean solar day consists of 24 equal parts called *hours*, these of 60 equal parts called *minutes*, and these again of 60 equal parts called *seconds*. Consequently, the second is the 86,400th part of a mean solar day, and is the generally received unit of time.

**22. Measure of space.**—Space may be either *length* or *distance*, which is space of one dimension; *area*, which is space of two dimensions; or *volume*, which is space of three dimensions. In England the standard of length is the British Imperial Yard, which is the distance between two fixed points on a certain metal rod, kept in the Tower of London, when the tempera-

ture of the whole rod is  $60^{\circ} \text{ F.} = 15^{\circ} \cdot 5 \text{ C.}$  It is, however, usual to employ as a unit, a *foot*, which is the third part of a yard. In France the standard of length is the *metre*; this is approximately equal to the ten-millionth part of a quadrant of the earth's meridian, that is of the arc from the Equator to the North Pole; it is practically fixed by the distance between two marks on a certain standard rod. The relation between these standards is as follows:

$$1 \text{ yard} = 0\cdot914383 \text{ metre.}$$

$$1 \text{ metre} = 1\cdot093633 \text{ yard.}$$

The unit of length having been fixed, the units of area and volume are connected with it thus: the *unit of area* is the area of a square, one side of which is the unit of length. The *unit of volume* is the volume of a cube, one edge of which is the unit of length. These units in the case of English measures are the square yard (or foot) and the cubic yard (or foot) respectively; in the case of French measures, the square metre and cubic metre respectively. The length of the seconds pendulum, in lat.  $45^{\circ}$ , which is about that of Milan, is  $0\cdot9935\text{m.}$ , and thus only differs from a metre by  $6\cdot5$  millimetres.

23. **Measure of mass.**—Two bodies are said to have equal masses when, if placed in a perfect balance *in vacuo*, they counterpoise each other. Suppose we take lumps of any substance, lead, butter, wood, stone, etc., and suppose that any one of them when placed on one pan of a balance will exactly counterpoise any other of them when placed on the opposite pan—the balance being perfect and the weighing performed *in vacuo*; this being the case, these lumps are said to have equal masses. That these lumps differ in many respects from each other is plain enough; in what respects they have the same properties in virtue of the equality of their masses is to be ascertained by subsequent enquiry.

The British unit of mass is the standard pound (avoirdupois), which is a certain piece of platinum kept in the Exchequer Office in London. This unit having been fixed, the mass of a given substance is expressed as a multiple or submultiple of the unit.

It need scarcely be mentioned that many distances are ascertained and expressed in yards which it would be physically impossible to measure directly by a yard measure. In like manner the masses of bodies are frequently ascertained and expressed numerically which could not be placed in a balance and subjected to direct weighing.

24. **Density and relative density.**—If we consider any body or portion of matter, and if we conceive it to be divided into any number of parts having equal volumes, then, if the masses of these parts are equal, in whatever way the division be conceived as taking place, that body is one of *uniform density*. The *density* of such a body is the mass of the *unit of volume*. Consequently if  $M$  denote the mass,  $V$  the volume, and  $D$  the density of the body, we have

$$M = VD.$$

If now we have an equal volume  $V$  of any second substance whose mass is  $M'$  and density  $D'$ , we shall have

$$M' = VD'.$$

Consequently  $D : D' :: M : M'$ ; that is the densities of substances are in the same ratio as the masses of equal volumes of those substances. If now

we take the density of distilled water at  $4^{\circ}$  C. to be unity, the relative density of any other substance is the ratio which the mass of any given volume of that substance at that temperature bears to the mass of an equal volume of water. Thus it is found that the mass of any volume of platinum is 22.069 times that of an equal volume of water, consequently the relative density of platinum is 22.069.

The relative density of a substance is generally called its *specific gravity*. Methods of determining it are given in Book III.

In French measures the *cubic decimetre* or *litre* of distilled water at  $4^{\circ}$  C. contains the unit of mass, the *kilogramme*; and therefore the mass in kilogrammes of  $V$  cubic decimetres of a substance whose specific gravity is  $D$ , will be given by the equation

$$M = VD.$$

The same equation will give the mass in *grammes* of the body, if  $V$  is given in cubic *centimetres*.

It has been ascertained that 27.7274 cubic inches of distilled water at the temperature of  $15^{\circ}.5$  C. or  $60^{\circ}$  F. contain a pound of matter. Consequently, if  $V$  is the *volume* of a body in cubic inches,  $D$  its *specific gravity*, its mass  $M$  in pounds avoirdupois will be given by the equation

$$M = \frac{VD}{27.7274}.$$

In this equation  $D$  is, properly speaking, the relative density of the substance at  $60^{\circ}$  F. when the density of water at  $60^{\circ}$  F. is taken as the unit.

25. **Velocity and its measure.**—When a material point moves, it describes a continuous line which may be either straight or curved, and is called its *path* and sometimes its *trajectory*. Motion which takes place along a straight line is called *rectilinear* motion; that which takes place along a curved line is called *curvilinear* motion. The rate of the motion of a point is called its *velocity*. Velocity may be either uniform or variable; it is *uniform* when the point describes equal spaces of portions of its path in all equal times; it is *variable* when the point describes unequal portions of its path in any equal times.

Uniform velocity is measured by the number of units of space described in a given unit of time. The units commonly employed are feet and seconds. If, for example, a velocity 5 is spoken of without qualification, this means a velocity of 5 feet per second. Consequently, if a body moves for  $t$  seconds with a uniform velocity  $v$ , it will describe  $vt$  feet.

The following are a few examples of different degrees of velocity expressed in this manner. A snail 0.005 feet in a second; the Rhine between Worms and Mainz 3.3; military quick step 4.6; moderate wind 10; fast sailing vessel 18.0; Channel steamer 22.0; railway train 36 to 75 feet; racehorse and storm 50 feet; eagle 100 feet; carrier pigeon 120 feet; a hurricane 160 feet; sound at  $0^{\circ}$  1,090; a point on the Equator in its rotation about the earth's axis 1,520; a Martini-Henry rifle bullet 1,330; a shot from an Armstrong gun 1,180; the centre of the earth 101,000; light and also electricity in a medium destitute of resistance 192,000 miles.

Variable velocity is measured at any instant by the number of units of space a body would describe if it continued to move uniformly from that

instant for a unit of time. Thus, suppose a body to run down an inclined plane, it is a matter of ordinary observation that it moves more and more quickly during its descent; suppose that at any point it has a velocity 15, this means that at that point it is moving at the rate of 15 ft. per second, or in other words, if from that point all increase of velocity ceased, it would describe 15 ft. in the next second.

**26. Force.**—When a material point is at rest, it has no innate power of changing its state of rest; when it is in motion it has no innate power of changing its state of uniform motion in a straight line. This property of matter is termed its *inertia* (19). Any cause which sets a point in motion, or which changes the magnitude or direction of its velocity if in motion, is a *force*. *Gravity, friction, elasticity* of springs or gases, *electrical or magnetic attraction or repulsion*, etc., are *forces*. All changes observed in the motion of bodies can be referred to the action of one or more forces.

According to the length of time during which it acts, a force may be either momentary—such as the forces called into play in an explosion, an impact, or the discharge of an electrical spark—or it may be continuous and permanent, like the attraction of a magnet or of gravitation, or the forces called into play by an electrical current. The effect of a force of the former kind (which is called an impulsive force) is, as far as our observation permits, an instantaneous change in the momentum (28) of the body on which it acts, while the effects of forces of the latter kind are produced gradually, and require the lapse of time to exhibit themselves. In order that impulsive forces may produce any appreciable effects, their intensity, during the moment of their action, must be indefinitely greater than that of continuous forces. An impulsive force is measured by the instantaneous change in the momentum of the body on which it acts. If the strength of a continuous force does not vary, it is called a *constant* force.

**27. Accelerative effect of force.**—If we suppose a force to continue unchanged in magnitude, and to act along the line of motion of a point, it will communicate in each successive second a constant increase of velocity. This constant increase is the *accelerative effect of the force*. Thus, if at any given instant the body has a velocity 10, and if at the end of the first, second, third, etc., second from that instant its velocity is 13, 16, 19, etc., the accelerative effect of the force is 3; a fact which is expressed by saying that the body has been acted on by an accelerating force 3.

If the force vary from instant to instant, its accelerative effect will also vary; when this is the case the accelerative effect at any instant is measured by the velocity it would communicate in a second if the force continued constant from that instant.

By means of an experiment to be described below (80) it can be shown that at any given place the accelerative effect of gravity  $g$  is constant; but it is found to have different values at different places; adopting the units of feet and seconds it is found that with sufficient approximation

$$g = f(1 - 0.00256 \cos 2\phi)$$

at a place whose latitude is  $\phi$ , where  $f$  denotes the number 32.1724, that is the effect of gravity in latitude  $45^\circ$ .

If we adopt the units of metres and seconds, then  $f = 9.8059$ .

28. **Momentum** or quantity of motion is a magnitude varying as the mass of a body and its velocity jointly, and is therefore expressed numerically by the product of the number of units of mass which it contains,  $m$ , and the number of units of velocity,  $v$ , in its motion, or by  $m v$ . Thus a body containing 5 lbs. of matter, and moving at the rate of 12 ft. per second, has a momentum of 60.

29. **Measure of force.**—Force, when constant, is measured by the *momentum* it communicates to a body in a unit of time. If the force varies, it is then measured at any instant by the momentum it would communicate if it continued constant for a unit of time from the instant under consideration. On the British system of weights and measures the *unit of force* is that force which acting on a pound of matter would produce in one second a velocity of one foot per second. Consequently if a body contains  $m$  lbs. of matter, and is acted on by a force whose accelerative effect is  $f$ , that force contains a number of units of force ( $F$ ), given by the equation

$$F = mf.$$

The weight of a body, *when that term denotes a force*, is the force exerted on it by gravity; consequently, if  $m$  is the mass of the body, and  $g$  the accelerating force of gravity, the number of units of force  $W$  exerted on it by gravity is given by the equation

$$\begin{aligned} W &= mg \\ \text{or (27)} \quad W &= mf(1 - 0.00256 \cos 2\phi). \end{aligned}$$

From this it is plain that the weight of the same body will be different at different parts of the earth's surface; this could be verified by attaching a piece of platinum (or other metal) to a delicate spring, and noting the variations in the length of the spring during a voyage from a station in the Northern Hemisphere to another in the Southern Hemisphere—for instance, from London to the Cape of Good Hope.

When, therefore, a *pound* is used as a unit of force it must be understood to mean the force  $W$  exerted by gravity on a pound of matter in London. Now, in London, the latitude of which is  $51^{\circ}30'$ , the numerical value of  $g$  is 32.1912, so that

$$W = 1 \times 32.1912;$$

in other words, when a pound is taken as the unit of force it contains 32.1912 units of force according to the measure given above. It will be observed that a pound of matter is a completely determinate quantity of matter irrespective of locality, but gravity exerts on a pound of matter a pound (or 32.1912 units) of force at London and other places in about the same latitude as London only; this ambiguity in the term *pound* should be carefully noticed by the student; the context in any treatise will always show in which sense the term is used. The absolute unit of force as defined above is constant; it is about equal to a weight of half an ounce at London.

30. **Representation of forces.**—Draw any straight line  $AB$ , and fix on any point  $O$  in it. We may suppose a force to act on the point  $O$ , along the line  $AB$ , either towards  $A$  or  $B$ : then  $O$  is called the *point of application* of the force,  $AB$  its line of action; if it acts towards  $A$ , its *direction* is  $OA$ , if



toward B, its direction is OB. It is rarely necessary to make the distinction between the line of action and direction of a force; it being very convenient to make the convention that the statement—a force

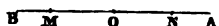

Fig. 3.

acts on a point O along the line OA—means that it acts from O to A. Let us suppose the force which acts on O along OA to contain P units of force; from O towards A measure ON containing P units of length, the line ON is said to *represent* the force. The analogy between the line and the force is very complete; the line ON is drawn from O in a given direction OA, and contains a given number of units P, just as the force acts on O in the direction OA, and contains a given number of units P. It is scarcely necessary to add, that if an equal force were to act on O in the opposite direction, it would be said to act in the direction OB, and would be represented by OM, equal in magnitude to ON.

When we are considering several forces acting along the same line we may indicate their directions by the positive and negative signs. Thus the forces mentioned above would be denoted by the symbols + P and - P respectively.

31. **Forces acting along the same line.**—If forces act on the point O in the direction OA equal to P and Q units respectively, they are equivalent to a single force R containing as many units as P and Q together, that is,

$$R = P + Q.$$

If the sign + in the above equation denote *algebraical* addition, the equation will continue true whether one or both the forces act along OA or OB. It is plain that the same rule can be extended to any number of forces, and if several forces have the same line of action they are equivalent to one force containing the same number of units as their *algebraical* sum. Thus if forces of 3 and 4 units act on O in the direction OA, and a force of 8 in the direction OB, they are equivalent to a single force containing R units given by the equation

$$R = 3 + 4 - 8 = -1;$$

that is, R is a force containing one unit acting along OB. This force R is called their *resultant*. If the forces are in equilibrium R is equal to zero.

In this case the forces have equal tendencies to move the point O in opposite directions.

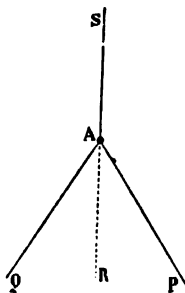

Fig. 4.

32. **Resultant and components.**—In the last article we saw that a single force R could be found equivalent to several others; this is by no means peculiar to the case in which all the forces have the same line of action; in fact, when a material point, A (fig. 4), remains in equilibrium under the action of several forces, S, P, Q, it does so because any one of the forces, as S, is capable of neutralising the combined effects of all the others. If the force S, therefore, had its direction reversed, so as to act along AR, the prolongation of AS, it would produce the same effect as the system of forces P, Q.

Now, a force whose effect is equivalent to the combined effects of several other forces is called their *resultant*, and with respect to this resultant, the other forces are termed *components*.

When the forces,  $P$ ,  $Q$ , act on a point they can only have *one* resultant ; but any single force can be resolved into components in an indefinite number of ways.

If a point move from rest, under the action of any number of forces, it will begin to move in the direction of their resultant.

33. **Parallelogram of forces.**—When two forces act on a point their resultant is found by the following theorem, known as the principle of the parallelogram of forces :—*If two forces act on a point, and if lines be drawn from that point representing the forces in magnitude and direction, and on these lines as sides a parallelogram be constructed, their resultant will be represented in magnitude and direction by that diagonal which passes through the point.* Thus let  $P$  and  $Q$  (fig. 5) be two forces acting on the point  $A$  along  $AP$  and  $AQ$  respectively, and let  $AB$  and  $AC$  be taken containing the same number of units of length that  $P$  and  $Q$  contain units of force ; let the parallelogram  $ABDC$  be completed, and the diagonal  $AD$  drawn ; then the theorem states that the resultant,  $R$ , of  $P$  and  $Q$  is represented by  $AD$  ; that is to say,  $P$  and  $Q$  together are equal to a single force  $R$  acting along the line  $AD$ , and containing as many units of force as  $AD$  contains units of length.

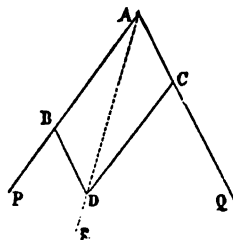

Fig. 5.

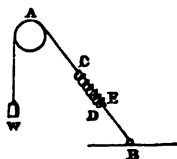

Fig. 6.

Proofs of this theorem are given in treatises on Mechanics ; we will here give an account of a direct experimental verification of its truth ; but before doing so we must premise an account of a very simple experiment.

Let  $A$  (fig. 6) be a small pulley, and let it turn on a smooth, hard, and thin axle with little or no friction : let  $W$  be a weight tied to the end of a fine thread which passes over the pulley : let a spring  $CD$  be attached by one end to the end  $C$  of the thread and by the end  $D$  to another piece of thread, the other end of which is fastened to a fixed point  $B$  ; a scale  $CE$  can be fastened by one end to the point  $C$  and pass inside the spring so that the elongation of the spring can be measured. Now it will be found on trial that with a given weight  $W$  the elongation of the spring will be the same whatever the angle contained between the parts of the string  $WA$  and  $BA$ . Also it would be found that if the whole were suspended from a fixed point, instead of passing over the pulley, the weight would in this case stretch the spring to the same extent as before. This experiment shows that when care is taken to diminish to the utmost the friction of the axle of the pulley, and the imperfect flexibility of the thread, the weight of  $W$  is transmitted without sensible diminution to  $B$ , and exerts on that point a pull or force along the line  $BA$  virtually equal to  $W$ .

This being premised, an experimental proof, or illustration of the parallelogram of forces, may be made as follows :—

Suppose H and K (fig. 7) to be two pulleys with axles made as smooth and fine as possible ; let P and Q be two weights suspended from fine and

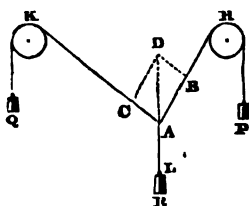

Fig. 7.

flexible threads which, after passing over H and K, are fastened at A to a third thread AL from which hangs a weight R ; let the three weights come to rest in the positions shown in the figure. Now the point A is acted on by three forces in equilibrium, viz., P from A to H, Q from A to K, and R from A to L, consequently any one of them must be equal and opposite to the resultant of the other two. Now if we suppose the apparatus to be arranged immediately in front of a large slate, we can draw lines upon it coinciding with AH, AK, and AL. If now we measure off along AH the part AB containing as many inches as P contains pounds, and along AK the part AC containing as many inches as Q contains pounds, and complete the parallelogram ABCD, it will be found that the diagonal AD is in the same line as AL, and contains as many inches as R weighs pounds. Consequently, the resultant of P and Q is represented by AD. Of course, any other units of length and force might have been employed. Now it will be found that when P, Q, and R are changed in any way whatever, consistent with equilibrium, the same construction can be made,—the point A will have different positions in the different cases ; but when equilibrium is established, and the parallelogram ABCD is constructed, it will be found that AD is vertical, and contains as many units of length as R contains units of force, and consequently it represents a force equal and opposite to R, that is, it represents the resultant of P and Q.

**34. Resultant of any number of forces acting in one plane on a point.**—Let the forces P, Q, R, S (fig. 8) act on the point A, and let them be represented by the lines AB, AC, AD, AE, as shown in the figure.

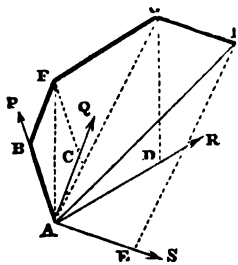

Fig. 8.

*First*, complete the parallelogram ABFC and join AF ; this line represents the resultant of P and Q. *Secondly*, complete the parallelogram AFGD and join AG ; this line represents the resultant of P, Q, R. *Thirdly*, complete the parallelogram AGHE and join AH ; this line represents the resultant of P, Q, R, S. It is manifest that the construction can be extended to any number of forces. A little consideration will show that the line AH might be determined by the following construction :—Through B draw BF parallel to, equal to, and towards the same part as AC ; through F draw FG parallel to, equal to, and towards the same part as AD ; through G draw GH parallel to, equal to, and towards the same part as AE ; join AH, then AH represents the required resultant.

In place of the above construction, the resultant can be determined by calculation in the following manner :—Through A draw any two rectangular

axes  $Ax$  and  $Ay$  (fig. 9), and let  $\alpha, \beta, \gamma$  be the angles made with the axis  $Ax$  by the lines representing the pressures, then  $P, Q, R$  can be resolved into  $P \cos \alpha, Q \cos \beta, R \cos \gamma$ , acting along  $Ax$ , and  $P \sin \alpha, Q \sin \beta, R \sin \gamma$ , acting along  $Ay$ . Now the former set of forces can be reduced to a single force  $X$  by addition, attention being paid to the sign of each component; and in like manner the latter forces can be reduced to a single force  $Y$ , that is,

$$X = P \cos \alpha + Q \cos \beta + R \cos \gamma + \dots$$

$$Y = P \sin \alpha + Q \sin \beta + R \sin \gamma + \dots$$

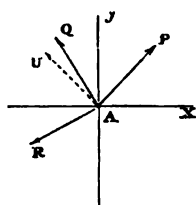

Fig. 9.

Since the addition denotes the *algebraical* sum of the quantities on the right-hand side of the equations, both *sign* and *magnitude* of  $X$  and  $Y$  are known. Suppose  $U$  to denote the required resultant, and  $\phi$  the angle made, by the line representing it, with the axis  $Ax$ ;

then

$$U \cos \phi = X, \text{ and } U \sin \phi = Y.$$

These equations give  $U^2 = X^2 + Y^2$ , which determines the magnitude of the resultant, and then, since both  $\sin \phi$  and  $\cos \phi$  are known,  $\phi$  is determined without ambiguity.

Thus let  $P, Q,$  and  $R$  be forces of 100, 150, and 120 units, respectively, and suppose  $\alpha AP, \alpha AQ,$  and  $\alpha AR$  to be angles of  $45^\circ, 120^\circ,$  and  $210^\circ$  respectively. Then their components along  $Ax$  are  $70.7, -75, -103.9$ , and their components along  $Ay$  are  $70.7, +129.9, -60$ . The sums of these two sets being respectively  $-108.2$  and  $140.6$ , we have  $U \cos \phi = -108.2$  and  $U \sin \phi = 140.6$ ;

therefore

$$U^2 = (108.2)^2 + (140.6)^2$$

or

$$U = 177.4$$

hence

$$177.4 \cos \phi = -108.2, \text{ and } 177.4 \sin \phi = 140.6.$$

If we made use of the former of these equations only, we should obtain  $\phi$  equal to  $232^\circ 25'$ , or  $127^\circ 35'$ , and the result would be ambiguous: in like manner, if we determined  $\phi$  from the second equation only, we should have  $\phi$  equal to  $52^\circ 25'$ , or  $127^\circ 35'$ ; but as we have both equations, we know that  $\phi$  equals  $127^\circ 35'$ , and consequently the force  $U$  is completely determined as indicated by the dotted line  $AU$ .

**35. Conditions of equilibrium of any forces acting in one plane on a point.**—If the resultant of the forces is zero, they have no joint tendency to move the point, and consequently are in equilibrium. This obvious principle enables us to deduce the following constructions and equations, which serve to ascertain whether given forces will keep a point at rest.

Suppose that in the case represented in fig. 8,  $T$  is the force which will balance  $P, Q, R, S$ . It is plain that  $T$  must act on  $A$  along  $HA$  produced, and in magnitude must be proportional to  $HA$ ; for then the resultant of the five forces will equal zero, since the broken line  $ABFGHA$  returns to the point  $A$ . This construction is plainly equivalent to the following: Let  $P, Q, R$  (fig. 10) be forces acting on the point  $O$ , as indicated, their magnitudes and directions being given. It is known that they are balanced by a fourth force,  $S$ , and it is required to determine the magnitude and direction of  $S$ .

Take any point D, and draw any line parallel to and towards the same part as OP, draw AB parallel to and towards the same part as OQ, and take AB such that  $P : Q :: DA : AB$ . Through B draw BC parallel to and towards the same part as OR, taking BC such that  $Q : R :: AB : BC$ ; join CD; through O draw OS parallel to and towards the same part as CD, then the required force S acts along OS, and is in magnitude proportional to CD.

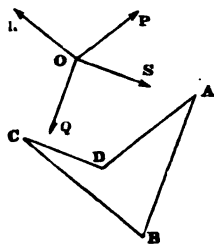

Fig. 10.

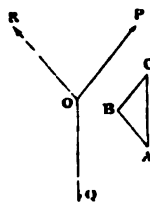

Fig. 11.

It is to be observed that this construction can be extended to any number of forces, and will apply to the case in which these directions are not in one plane, only in this case the broken line ABCD would not lie wholly in one plane. The above construction is frequently called the *Polygon of Forces*.

The case of three forces acting on a point is, of course, included in the above; but its importance is such that we may give a separate statement of it. Let P, Q, R (fig. 11) be three forces in equilibrium on the point O. From any point B draw BC parallel to and towards the same part as OP, from C draw CA parallel to and towards the same part as OQ, and take CA such that  $P : Q :: BC : CA$ ; then, on joining AB, the third force R must act along OR parallel to and towards the same part as AB, and must be proportional in magnitude to AB. This construction is frequently called the *Triangle of Forces*. It is evident that while the sides of the triangle are severally proportional to P, Q, R, the angles A, B, C are supplementary to QOR, ROP, POQ respectively, consequently every trigonometrical relation existing between the sides and angles of ABC will equally exist between the forces P, Q, R, and the supplements of the angles between their directions. Thus in the triangle ABC it is known that the sides are proportional to the sines of the opposite angles; now, since the sines of the angles are equal to the sines of their supplements, we at once conclude that *when three forces are in equilibrium, each is proportional to the sine of the angle between the directions of the other two*.

We can easily obtain from the equations which determine the resultant of any number of forces (34) equations which express the conditions of equilibrium of any number of forces acting in one plane on a point; in fact, if  $U = 0$  we must have  $X = 0$  and  $Y = 0$ ; that is to say, the required conditions of equilibrium are these:—

$$0 = P \cos \alpha + Q \cos \beta + R \cos \gamma + \dots$$

and

$$0 = P \sin \alpha + Q \sin \beta + R \sin \gamma + \dots$$

The first of these equations shows that no part of the motion of the point can take place along  $Ax$ , the second that no part can take place along  $Ay$ . In other words, the point cannot move at all.

36. **Composition and resolution of parallel forces.**—The case of the equilibrium of three parallel forces is merely a particular case of the equilibrium of three forces acting on a point. In fact let  $P$  and  $Q$  be two forces whose directions pass through the points  $A$  and  $B$ , and intersect in  $O$ ; let them be balanced by a third force  $R$  whose direction produced intersects the line  $AB$  in  $C$ . Now suppose the point  $O$  to move along  $AO$ , gradually receding from  $A$ , the magnitude and direction of  $R$  will continually change, and also the point  $C$  will continually change its position, but will always lie between  $A$  and  $B$ . In the limit  $P$  and  $Q$  become parallel forces, acting towards the same part balanced by a parallel force  $R$  acting towards the contrary part through a point  $X$  between  $A$  and  $B$ . The question is :—*First*, on this limiting case what is the value of  $R$ ; *secondly*, what is the position of  $X$ ? Now with regard to the first point it is plain that if a triangle  $abc$  were drawn as in art. 35, the angles  $a$  and  $b$  in the limit will vanish, and  $c$  will become  $180^\circ$ , consequently  $ab$  ultimately equals  $ac + cb$ ;

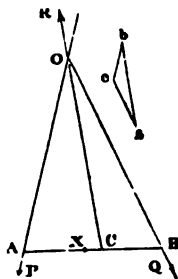

or 
$$R = P + Q.$$

With regard to the second point it is plain that

$$OC \sin POR = OC \sin AOC = AC \sin CAO$$

and 
$$OC \sin ROQ = OC \sin BOC = CB \sin CBO;$$

therefore 
$$AC \sin CAO : CB \sin CBO :: \sin POR : \sin ROQ$$
  

$$:: Q : P \text{ (35).}$$

Now in the limit, when  $OA$  and  $OB$  become parallel,  $OAB$  and  $OBA$  become supplementary; that is, their sines become equal; also  $AC$  and  $CB$  become respectively  $AX$  and  $XB$ ; consequently

$$AX : XB :: Q : P,$$

a proportion which determines the position of  $X$ . This theorem at once leads to the rules for the composition of any two parallel forces, viz.

I. When two parallel forces  $P$  and  $Q$  act towards the same part, at rigidly connected points  $A$  and  $B$ , their resultant is a parallel force acting towards the same part, equal to their sum, and its direction divides the line  $AB$  into two parts  $AC$  and  $CB$  inversely proportional to the forces  $P$  and  $Q$ .

II. When two parallel forces  $P$  and  $Q$  act towards contrary parts at rigidly connected points  $A$  and  $B$ , of which  $P$  is the greater, their resultant is a parallel force acting towards the same part as  $P$ , equal to the excess of  $P$  over  $Q$ , and its direction divides  $BA$  produced in a point  $C$  such that  $CA$  and  $CB$  are inversely proportional to  $P$  and  $Q$ .

In each of the above cases if we were to apply  $R$  at the point  $C$ , in opposite direction to those shown in the figure, it would plainly (by the above theorem) balance  $P$  and  $Q$ , and therefore when it acts as shown in figs. 13 and 14 it is the resultant of  $P$  and  $Q$  in those cases respectively. It will, of course, follow

that the force  $R$  acting at  $C$  can be resolved into  $P$  and  $Q$  acting at  $A$  and  $B$  respectively.

If the second of the above theorems be examined, it will be found that no force  $R$  exists equivalent to  $P$  and  $Q$  when these forces are equal. Two

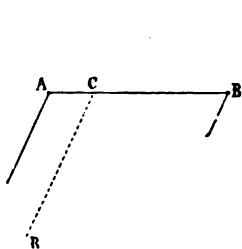

Fig. 13.

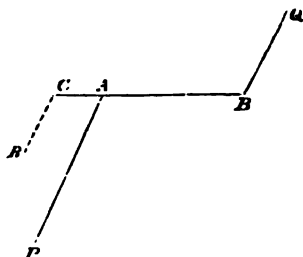

Fig. 14

such forces constitute a *couple*, which may be defined to be two equal parallel forces acting towards contrary parts; they possess the remarkable property that they are incapable of being balanced by any single force whatsoever.

In the case of more than two parallel forces the resultant of any two can be found, then of that and a third, and so on to any number; it can be shown that however great the number of forces they will either be in equilibrium or will reduce to a single resultant or to a couple.

37. **Centre of parallel forces.**—On referring to figs. 13 and 14, it will be remarked that if we conceive the points  $A$  and  $B$  to be fixed in the directions  $AP$  and  $BQ$  of the forces  $P$  and  $Q$ , and if we suppose those directions to be turned round  $A$  and  $B$ , so as to continue parallel and to make any given angles with their original directions, then the direction of their resultant will continue to pass through  $C$ ; that point is therefore called *the centre* of the parallel forces  $P$  and  $Q$ .

It appears from investigation, that whenever a system of parallel forces reduces to a single resultant, those forces will have a centre; that is to say, if we conceive each of the forces to act at a fixed point, there will be a point through which the direction of their resultant will pass when the directions of the forces are turned through any equal angles round their points of application in such a manner as to retain the parallelism of their directions.

The most familiar example of a centre of parallel forces is the case in which the forces are the weights of the parts of a body; in this case the forces all acting towards the same part will have a resultant, viz. their sum; and their centre is called *the centre of gravity* of the body.

38. **Moments of forces.**—Let  $P$  denote any force acting from  $B$  to  $P$ , take  $A$  any point, let fall  $AN$  a perpendicular from  $A$  on  $BP$ . The product of the number of units of force in  $P$ , and the number of units of length in  $AN$ , is called the moment of  $P$  with respect to  $A$ . Since the force  $P$  can be represented by a straight line, the moment of  $P$  can be represented by an area. In fact, if  $BC$  is the line representing  $P$ , the moment is properly represented by twice the area of the triangle  $ABC$ . The perpendicular  $AN$

is sometimes called the arm of the pressure. Now if a watch were placed with its face upwards on the paper, the force  $P$  would cause the arm  $AN$  to turn round  $A$  in the *contrary* direction to the hands of the watch. Under these circumstances, it is usual to consider the moment of  $P$  with respect to the point  $A$  to be positive. If  $P$  acted from  $C$  to  $B$ , it would turn  $NA$  in the *same* direction as the hands of the watch, and now its moment is reckoned *negative*.

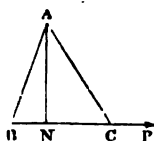

Fig. 15.

The following remarkable relation exists between any forces acting in one plane on a body and their resultant.

Take the moments of the forces and of their resultant with respect to any one point in the plane. Then the moment of the resultant equals the sum of the moments of the several forces, regard being had to the *signs* of the moments.

If the point about which the moments are measured be taken in the direction of the resultant, its moment with respect to that point will be zero; and consequently the sum of the moments with respect to such point will be zero.

39. **Equality of action and reaction.**—We will proceed to exemplify some of the principles now laid down by investigating the conditions of equilibrium of bodies in a few simple cases; but before doing so we must notice a law which holds good whenever a mutual action is called into play between two bodies. *Reaction is always equal and contrary to action: that is to say, the mutual actions of two bodies on each other are always forces equal in amount and opposite in direction.* This law is perfectly general, and is equally true when the bodies are in motion as well as when they are at rest. A very instructive example of this law has already been given (33), in which the action on the spring  $CD$  (fig. 6) is the weight  $W$  transmitted by the spring to  $C$ , and balanced by the reaction of the ground transmitted from  $B$  to  $D$ . Under these circumstances the spring is said to be stretched by a force  $W$ . If the spring were removed, and the thread were continuous from  $A$  to  $B$ , it is clear that any part of it is stretched by two equal forces, viz. an action and reaction, each equal to  $W$ , and the thread is said to sustain a tension  $W$ . When a body is urged along a smooth surface, the mutual action can only take place along the common perpendicular at the point of contact. If, however, the bodies are rough, this restriction is partially removed, and now the mutual action can take place in any direction not making an angle greater than some determinate angle with the common perpendicular. This determinate angle has different values for different substances, and is sometimes called the *limiting angle of resistance*, sometimes the *angle of repose*.

40. **The lever** is a name given to any bar straight or curved,  $AB$  (fig. 16) resting on a fixed point or edge  $c$  called the *fulcrum*. The forces acting on the lever are the *weight* or resistance  $Q$ , the *power*  $P$ , and the reaction of the fulcrum. Since these are in equilibrium, the resultant of  $P$  and  $Q$  must act through  $C$ , for otherwise they could not be balanced by the reaction. Draw  $cb$  at right angles to  $QB$  and  $ca$  to  $PA$  produced; then observing that  $P \times ca$ , and  $Q \times cb$  are the moments of  $P$  and  $Q$  with respect to  $c$ , and that they have contrary signs, we have by (38),

$$P \times ca = Q \times cb;$$



an equation commonly expressed by the rule, that *in the lever the power is to the weight in the inverse ratio of their arms.*

Lever is divided into three kinds, according to the position of the fulcrum with respect to the points of application of the power and the weight. In a *lever of the first kind* the fulcrum is between the power and resistance, as in fig. 16, and as in a poker and in the common steelyard ; a pair of scissors and a carpenter's pincers are double levers of this kind. In a *lever of the second kind* the resistance is between the power and the fulcrum, as in a wheelbarrow, or a pair of nutcrackers, or a door ; in a *lever of the third kind* the power is between the fulcrum and the resistance, as in a pair of tongs or the treadle of a lathe.

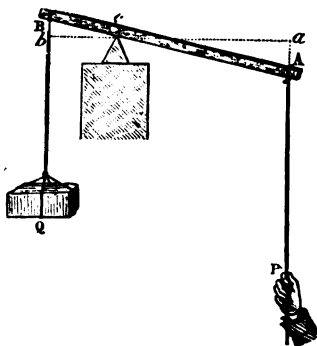

Fig. 16.

41. **Pulleys.**—The pulley is a hard circular disc of wood or of metal, in the edge of which is a groove, and which can turn freely on an axis in the centre. Pulleys are either *fixed*, as in fig. 17, where the stirrup or fork is rigidly connected with some immoveable body, and where the axis rotates in the stirrup ; or it may be *moveable* as in fig. 18, where the axis is fixed to the fork, and it passes through a hole in the centre of the disc. The rope which passes round the pulley in fig. 17 supports a weight at one end ; while at the other a pull is applied to hold this weight in equilibrium.

We may look upon the power and the resistance as acting at the circum-

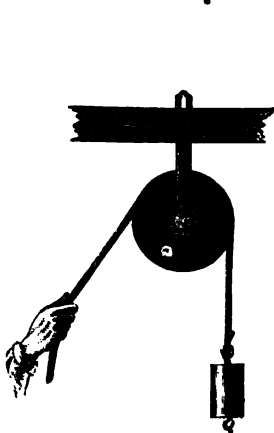

Fig. 17.

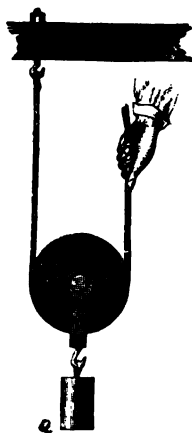

Fig. 18.

ference of the circle ; hence as the radii are equal, if we consider the pulley as a lever, the two arms are equal, and equilibrium will prevail when the power and the resistance are equal. The fixed pulley affords thus no mechanical

advantage, but is simply convenient in changing the direction of the application of a force.

In the case of the moveable pulley the one end of the rope is suspended to a fixed point in a beam, and the weight is attached to the hook on which the pulley acts. The tension of the rope is everywhere the same; one portion of the weight is supported by the fixed part and the other by the power, and these are equal to each other, and are together equal to the weight, including the pulley itself; hence in this case  $P = \frac{1}{2} Q$ .

If several pulleys are joined together on a common axis in a special sheath, which is fixed, and a rope passes round all those and also round a similar but moveable combination of pulleys, such an arrangement, which is represented in fig. 19, is called a *block and tackle*.

If we consider the condition of the rope it will be found to have everywhere the same tension; the weight  $Q$  which is attached to the hook common to the whole system is supported by the six portions of the rope; hence each of these portions will sustain one sixth of the weight; the force which is applied at the free end of the rope which passes over the upper pulley, and which determines the tension, will have the same value; that is to say, it will support one sixth of the weight.

The relation between power and resistance in a block and tackle is expressed by the equation  $P = \frac{Q}{n}$  in which  $P$  is the power,  $Q$  the weight, and  $n$  the number of cords by which the weight is supported.

**42. The wheel and axle.**—The older form of this machine is that of an axle, to which is rigidly fixed, concentric with it, a wheel of larger diameter. The power is applied tangentially on the wheel, and the resistance tangentially to the axle, as for instance in the treadmill and water-wheel. Sometimes, as in the case of the capstan, the power is applied to spokes fixed in the axle, which represent semi-diameters of the wheel; in other cases, as in the windlass, the handle is rigidly fixed to the axis.

In all its modifications we may regard the wheel and axle as an application of the lever, the arms of which are the radii of the wheel and axle respectively, and in all cases equilibrium exists where the power is to the resistance as the radius of the axle is to the radius of the wheel. Thus in fig. 20,  $P : Q = bc : ac$ , or  $P \times ac = Q \times bc$ .

Frequent applications of wheels of different diameters are met with in which the motion of one wheel is transmitted to another, either by means of teeth fitting in each other on the circumference of the wheels, as in fig. 21, or by means of bands passing over the two wheels, as in the illustration of Ladd's Magneto-Electrical Machine (see Book viii.).



Fig. 19.

In fig. 21 which represents the essential parts of a crab winch, in order to raise the weight  $Q$  a power  $p$  must be applied at the circumference of the

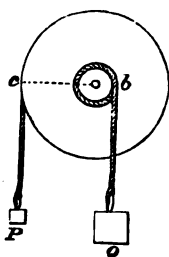

Fig. 20.



Fig. 21.

wheel such that  $p = Q \frac{r}{R}$  in which  $r$  and  $R$  are the radii of the axle  $b$  and of the toothed wheel  $a$  respectively.

The rotation of the wheel  $a$  is effected by means of the smaller wheel  $c$  or *crab*, the teeth of which fit in those of  $a$ . But if this wheel  $c$  is to exert at its circumference a power  $p$ , the power  $P$  which is applied at the end of the handle must be  $P = \frac{r'}{R'} p$ , in which  $r'$  is the radius of  $c$ ,  $R'$  the length of a lever at the end of which  $P$  acts, and consequently

$$P = \frac{r'r'}{RK'} Q.$$

The radius of the wheel  $c$  is to that of the wheel  $a$  as their respective circumferences; and, as the teeth of each are of the same size, the circumferences will be as the number of teeth.

Trains of wheel-work are used, not only in raising great weights by the exertion of a small power; as in screw jacks, cranes, crab winches, &c., but also in clock and watch works, and in cases in which changes in velocity or in power or even in direction are required. Numerous examples will be met with in the various apparatus described in this work.

43. **Inclined plane.**—The properties and laws of the inclined plane may

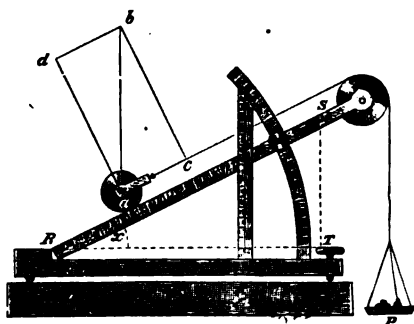

Fig. 22.

be conveniently demonstrated by means of the apparatus represented in fig. 22.  $RS$  represents the section of a smooth piece of hard wood hinged at  $R$ ; by means of a screw it can be clamped at any angle  $x$  against the arc-shaped support, by which at the same time the angle can be measured.  $a$  is a metal cylinder to the axis of which is attached a string passing over a pulley to a scale-pan  $P$ .

It is thus easy to ascertain by direct experiments what weights  $R$  must

be placed in the pan P in order to balance a roller of any given weight, or to cause it to move, with a given angle of inclination.

The line RS represents the *length*, ST the *height*, and RT the *base* of inclined plane.

In ascertaining the theoretical conditions of equilibrium we have a useful application of the parallelogram of forces. Let the line *ab*, fig. 22, represent the force which the weight W of the cylinder exerts acting vertically downwards; this may be decomposed into two others; one, *ad*, acting at right angles against the plane, and representing the *pressure* which the weight exerts against the plane; and which is counterbalanced by the reaction of the plane; the other, *ac*, represents the component which tends to move the weight down the plane, and this component has to be held in equilibrium by the weight, P, equal to it and acting in opposite directions.

It can be readily shown that the triangle *abc* is similar to the triangle SRT, and that the sides *ac* and *ab* are in the same proportion as the sides ST and SR. But the line *ac* represents the power, and the line *ab* the weight; hence

$$ST : SR = P : W ;$$

that is, on an inclined plane, equilibrium obtains *when the power is to the weight as the height of the inclined plane to its length.*

Since the ratio  $\frac{ST}{SR}$  is the sine of the angle *x* we may also state the principle thus :

$$P = W \sin x.$$

The component *da* or *bc*, which represents the actual pressure against the plane, is equal to  $W \cos x$ ; that is, the pressure against the plane is to the weight, as the base is to the length of the inclined plane.

In the above case it has been considered that the power acts parallel to the inclined plane. It may be applied so as to act horizontally. It will then be seen from figure 23 that the weight W may be decomposed into two forces, one of which, *ab*, acts at right angles to the plane, and the other, *ac*, parallel to the base. It is this latter which is to be kept in equilibrium by the power. From the similarity of the two triangles *acb* and STR,  $ac : bc = ST : TR = h : b$ ; but *bc* is equal to W, and *ac* is equal to P, hence the power which must be applied at *b* to hold the weight W in equilibrium is as the height of the inclined plane is to the base, or as the tangent of the angle of inclination *x*; that is,  $P = W \tan x$ . The pressure upon the plane in this case may be easily shown to be  $ab = \frac{bc}{\cos x}$ , that is  $= \frac{W}{\cos x}$ . This is sometimes called the *relative weight* on the plane.

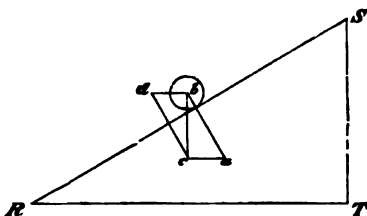

Fig. 23.

If the force P which is to counterbalance W is not parallel to the plane, but forms an angle, E, with it, this force can be decomposed into one

which is parallel to it, and one which is at right angles. Of these only the first is operative and is equal to  $P \cos E$ .

In most cases of the use of the inclined plane, such as in moving carriages and waggons along roads, in raising casks into waggons or warehouses, the power is applied parallel to the inclined plane. An instance of a case in which a force acts parallel to the base is met with in the screw.

Owing to the unevenness of the surfaces in actual use, the laws of equilibrium and of motion on an inclined plane undergo modification. The *friction*, for instance, which comes into play amounts on ordinary roads to from  $\frac{1}{15}$  to  $\frac{1}{30}$ , and on railways to from  $\frac{1}{180}$  to  $\frac{1}{240}$  of the relative weight. This must be looked upon as a hindrance to be continually overcome, and must be deducted from the force required to keep a body from falling down an inclined plane, or must be added to it, in the case in which a body is to be moved up the plane. Hence the use of the inclined plane in unloading heavy casks into cellars, etc.

A body on an inclined plane which cannot rotate does not move provided the inclination is below a certain amount. The determination of this *limiting angle of resistance*, at which a body on an inclined plane just begins to move, may serve as a rough illustration of a mode of ascertaining the 'coefficient of friction.'

For in the case in which the power is applied parallel to the plane, the component of the weight which presses against the plane or the actual load,  $L$ , is  $W \cos x$ ; and the component which tends to move the body down the plane is equal to  $W \sin x$ . If the friction,  $R$ , is just sufficient to hold this in equilibrium, the coefficient of friction will be  $\frac{R}{L} = \frac{W \sin x}{W \cos x} = \tan. x$ .

Thus if we place on the plane a block of the same material, by gradually increasing the inclination it will begin to move at a certain angle, which will depend on the nature of the material; this angle is the limiting angle of resistance, and its tangent is the coefficient of friction for that material.

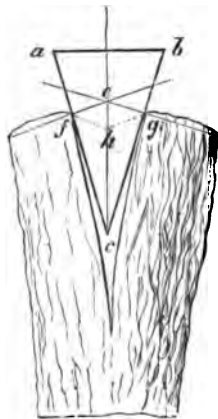

Fig. 24.

**44. The Wedge.**—The ordinary form of the wedge is that of a three-sided prism of iron or steel, one of whose angles is very acute. Its most frequent use is in splitting stone, timber, etc. Fig. 24 represents in section the application of the wedge to this purpose. The side  $ab$  is the *back*, the vertex of the angle  $acb$  which the two faces  $ac$  and  $bc$  make with each other represents the *edge*, and the faces  $ac$  and  $bc$  the *sides* of the wedge. The power  $P$  is usually applied at right angles to the back; and we may look upon the cohesion between the fibres of the wood as representing the resistance to be overcome; as corresponding to what in other machines is the weight. Suppose this to act at right angles to the two faces of the wedge, and to be represented by the lines  $fe$  and  $ge$ ; complete the parallelogram  $gef$ , then the diagonal  $he$  will represent the resultant of the reaction of the fibres tending to force the wedge out; the force which must be applied to hold this wedge in equilibrium must therefore be equal to  $eh$ . Now

$efh$  is similar to the triangle  $acb$ , therefore  $ab : ac = eh : ef$ , but these lines represent the pressure applied at the back of the wedge, and the pressure on the force  $ac$ , hence if  $P$  represent the former and  $Q$  the latter, there is equilibrium when  $P : Q = ab : bc$ , that is, when the power is to the resistance in the same ratio as the back of the wedge bears to one of the sides. The relation between power and resistance is more favourable the sharper the edge, that is, the smaller the angle which the sides make with each other.

The action of all sharp cutting instruments, such as chisels, knives, scissors, etc., depends on the principle of the wedge. It is also applied when very heavy weights are to be raised through a short distance, as in launching ships; and in bracing columns and walls to the perpendicular.

45. **The Screw.**—Let us suppose a piece of paper in the shape of a right-angled triangle  $aed$  be applied with its vertical side  $ac'e'$  against a cylinder, and parallel to the axis, and be wrapped round the cylinder; the hypotenuse will describe on the surface of the cylinder a screw line or *helix* (fig. 25); the points  $a b c d e$  will occupy the positions respectively  $a b' c'$



Fig. 25.

$a' c'$ . If the dimensions be so chosen that the base of the triangle  $c' c'$  is equal to the circumference of the cylinder, then the hypotenuse  $abc$  becomes an inclined plane traced on the surface of the cylinder; the distance  $a' c'$  being the height of the plane.

An ordinary screw consists of an elevation on a solid cylinder; this elevation may be either square, as in fig. 26, or acute, and such screws are called *square* or *sharp* screws accordingly.

When a corresponding groove is cut in the hollow cylinder or nut of the same diameter as the bolt, this gives rise to an internal or companion screw or *nut*, fig. 27.

The vertical distance between any two threads of a screw measured parallel to the axis is called the *pitch*, and the angle  $acc'$  or  $aed'$  is called the *inclination* of the screw.

In use, a raised screw is used with its companion in such a manner that the elevations of the one fit into, and coincide with, the depressions of the other. The screw is a modification of the inclined plane, and the conditions of equilibrium are those which obtain in the case of the plane. The resistance, which is either a weight to be raised or a pressure to be exerted, acts in the direction of the vertical, and the power acts parallel to the base; hence we have  $P : R = h : b$ , and the length of the base is the circumference of the cylinder; whence  $P : R = h : 2\pi r$ ;  $r$  being the radius of the cylinder, and  $h$  the pitch of the screw.



Fig. 26.



Fig. 27.

The power is usually applied to the screw by means of a lever, as in the book-binders' press, &c., and the principle of the screw may be stated to be generally that the power of the screw is to the resistance in the same ratio as the pitch of the screw bears to the circumference of the circle through which the power acts.

**46. Virtual Velocity.**—If the point of application of a force be slightly displaced, the resolved part of the displacement in the direction of the force is termed the virtual velocity of the force, and is considered as positive or negative, according as it is in the same direction as the force, or in the opposite direction. Thus, in the figure (27a), let the point of application A of the force P be displaced to A', and draw A'a perpendicular to AP. Then Aa is the virtual velocity of the force P, and being, in this case, in the direction of P, is to be considered positive.

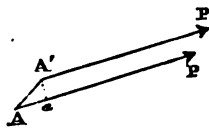

Fig. 27a.

The principle of virtual velocities asserts that if any machine or system be kept in equilibrium by any number of forces, and the machine or system then receive any *very small* displacement, the algebraic sum of the products formed by multiplying each force by its virtual velocity will be zero. Of course, the displacement of the machine is supposed to be such as not to break the connection of its parts; thus in the wheel and axle the only possible displacement is to turn it round the fixed axle; in the inclined plane the weight must still continue to rest on the plane; in the various systems of pulleys the strings must still continue stretched, and must not alter in length, &c.

The complete proof of this principle is beyond the scope of the present work, but we may easily establish its truth in any of the machines we have already considered. It will be found in every case that, if the machine receive a small displacement, the virtual velocities of P and W will be of opposite signs, and that, neglecting the signs,  $P \times P$ 's virtual velocity =  $W \times W$ 's virtual velocity. Thus, to take the case of the bent lever, let P and Q be the forces acting at the extremities of the arms of the bent lever AFB (fig. 27b),

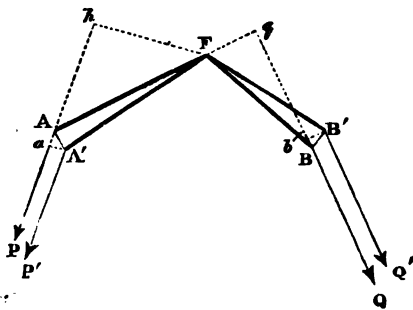

Fig. 27b.

and let the lever be turned slightly round its fulcrum F, bringing A to A', and B to B'. Draw A'a and B'b perpendicular to P and Q respectively; then Aa is the virtual velocity of P, and Bb that of Q, the former being positive and the latter negative. Let Fp, Fq be the perpendiculars from the fulcrum upon P and Q, or what we have called (art. 40) the arms of P and Q. Now, as the displacement is very small, the angles FAA', FBB' will be very nearly right angles; and, therefore, the right-angled triangles AaA', BbB', will ultimately be similar to the triangles FpA, FqB respectively, whence  $\frac{Aa}{AA'} = \frac{Fp}{FA}$ , and  $\frac{Bb}{BB'} = \frac{Fq}{FB}$  or  $\frac{Aa}{Fp} = \frac{AA'}{FA}$ , and  $\frac{Bb}{Fq} = \frac{BB'}{FB}$ . But the tri-

angles  $FAA'$ ,  $FBB'$  are similar, as they are both isosceles, and their vertical angles are equal, so that  $\frac{AA'}{FA} = \frac{BB'}{FB}$ ; whence  $\frac{Aa}{Fp} = \frac{Bb}{Fq}$  or, as we may put it,  $\frac{P \times Aa}{P \times Fp} = \frac{Q \times Bb}{Q \times Fq}$ . Now the denominators of these two equal fractions are equal, if the lever be in equilibrium (art. 40). Hence the numerators are equal, or

$$P \times P's \text{ virtual velocity} = Q \times Q's \text{ virtual velocity.}$$

As a further and simpler example, take the case of the block and tackle described in article 41. Suppose the weight to be raised through a space  $h$ ; then the virtual velocity of the weight is  $h$ , and is negative. Now as the distance between the block and tackle is less than before by the space  $h$ , and as the rope passes over this space  $n$  times, in order to keep the rope still tight the power will have to move through a space equal to  $nh$ . This is the virtual velocity of  $P$ , and is positive, and as  $W = nP$ , we see that

$$W \times W's \text{ virtual velocity} = P \times P's \text{ virtual velocity.}$$

**47. Friction.**—In the cases of the actions of machines which have been described, the resistances which are offered to motion have not been at all considered. The surfaces of bodies in contact are never perfectly smooth; even the smoothest present inequalities which can neither be detected by the touch nor by ordinary sight; hence when one body moves over the surface of another the elevations of one sink into the depressions of the other, like the teeth of wheels, and thus offer a certain resistance to motion; this is what is called *friction*. It must be regarded as a force which continually acts in opposition to actual or possible motion.

Friction is of two kinds: *sliding*, as when one body glides over another; this is least when the two surfaces in contact remain the same, as in the motion of an axle in its bearing; and *rolling* friction, which occurs when one body rolls over another, as in the case of an ordinary wheel. The latter is less than the former, for by the rolling the inequalities of one body are raised over those of the other.

Friction is directly proportional to the pressure of the two surfaces against each other. That fraction of the pressure which is required to overcome friction is called the *coefficient of friction*.

Friction is independent of the extent of the surfaces in contact if the pressure is the same. Thus, suppose a board with a surface of a square decimetre resting on another board to be loaded with a weight of a kilogramme. If this load be distributed over a similar board of two square decimetres surface, the total friction will be the same, while the friction per square centimetre is one half, for the pressure on each square centimetre is one half of what it was before. Friction is diminished by polishing and by smearing, but is increased by heat. It is greater as a body passes from the state of rest to that of motion than during motion, but seems independent of the velocity. The coefficient of friction depends on the nature of the substances in contact; thus for oak upon oak it is 0.418 when the fibres are parallel, and 0.293 when they cross; for beech upon beech it is 0.36. Greasy substances which are not absorbed by the body diminish friction; but increase it if they are absorbed. Thus moisture and oil increase, while tallow, soap, and graphite diminish, the friction of wooden surfaces. In the sliding friction of cast iron upon bronze



the coefficient was found to be 0.25 without grease; with oil it was 0.17, fat 0.11, soap 0.03, and with a mixture of fat and graphite 0.02. The coefficient of rolling friction for cast iron wheels on iron rails is 0.004; for ordinary wheels on an ordinary road it is 0.04.

As rolling friction is considerably less than sliding friction, it is a great saving of power to convert the latter into the former, as is done in the case of the casters of chairs and other furniture. On the other hand, it is sometimes useful to change rolling into sliding friction, as when drags are placed on carriage wheels.

Without friction on the ground, neither men nor animals, neither ordinary carriages nor railway carriages, could move. Friction is necessary for the transmission of power from one wheel to another by means of bands or ropes; and without friction we could hold nothing in the hands.

48. **Resistance to Motion in a Fluid Medium.**—A body in moving through any medium such as air or water experiences a certain resistance; for the moving body sets in motion those parts of the medium with which it is in contact, whereby it loses an equivalent amount of its own motion.

This resistance increases with the surface of the moving body, thus a soap bubble or a snow flake falls more slowly than does a drop of water of the same weight. It also increases with the density of the medium; thus in rarefied air it is less than in air under the ordinary pressure; and in this again it is less than in water.

The influence of this resistance may be illustrated by means of the apparatus represented in fig. 28, which consists of two vanes, *w w*, fixed to a horizontal axis, *xx*, to which also is attached a bobbin *s*. The rotation of the vanes is effected by means of the falling of a weight attached to the string coiled round the bobbin. The vanes can be adjusted either at right angles or parallel to the axis. In the former position the vanes rotate rapidly when the weight is allowed to act; in the latter, however, where they press with their entire surface against the air, the resistance greatly lessens the rapidity of rotation.

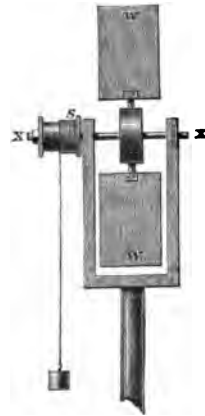

Fig. 28.

The resistance increases with the velocity of the moving body, and for moderate velocities is proportional to the square; for, supposing the velocities of a body made twice as great, it must displace twice as much matter, and must also impart to the displaced particles twice the velocity. For high velocities the resistance in a medium increases in a more rapid ratio than that of the square, for some of the medium is carried along with the moving body, and this, by its friction against the other portions of the medium, causes a loss of velocity.

It is this resistance which so greatly increases the difficulty and cost of attaining very high speeds in steam-vessels. Use is made, on the other hand, of this resistance in parachutes (fig. 148) and in the wind-vanes for diminishing the velocity of falling bodies (fig. 53), the principle of which is illustrated by the apparatus, fig. 28. A rain-drop falling from a height of 3,000 feet would, when

near the ground, have a velocity of nearly 440 feet, or that of a musket-shot ; owing, however, to the resistance of the air, its actual velocity is probably not more than 30 feet in a second. On-railways the resistance of the air is appreciable ; with a carriage exposing a surface of 22 square feet, it amounts to 16 or 17 pounds, when the speed of the train is 16 feet a second or 11 miles an hour.

By observing the rate of diminution in the number of oscillations of a horizontal disc suspended by a thread, when immersed in water, Meyer determined the coefficient of resistance, and found that at  $10^\circ$  it was equal to 0.01567 grammes on a square centimetre ; and for air it was about  $\frac{1}{10}$  as much.

**49. Uniformly Accelerated Rectilinear Motion.**—Let us suppose a body containing  $m$  units of mass to move from rest under the action of a force of  $F$  units, the body will move in the line of action of the force, and will acquire in each second an additional velocity  $f$  given by the equation.

$$F = mf$$

consequently, if  $v$  is its velocity at the end of  $t$  seconds, we have

$$v = ft. \tag{1}$$

To determine the space it will describe in  $t$  seconds, we may reason as follows :—The velocity at the time  $t$  being  $ft$ , that at a time  $t + \tau$  will be  $f(t + \tau)$ . If the body moved uniformly during the time  $\tau$  with the former velocity it would describe a space  $s$  equal to  $ftr$ ; if with the latter velocity, a space  $s_1$  equal to  $f(t + \tau)r$ . Consequently,

$$s_1 : s :: t + \tau : t ;$$

therefore, when  $\tau$  is indefinitely small, the limiting values of  $s$  and  $s_1$  are equal. Now since the body's velocity is continually *increasing* during the time  $\tau$ , the space actually described is greater than  $s$ , and less than  $s_1$ . But since the limiting values of  $s$  and  $s_1$  are equal, the limiting value of the space described is the same as that of  $s$  or  $s_1$ . In other words, if we suppose the whole time of the body's motion to be divided into any number of equal parts, if we determine the velocity of the body at the beginning of each of these parts, and if we ascertain the spaces described on the supposition that the body moves uniformly during each portion of time, the limiting value of the sum of these spaces will be the space actually described by the body. Draw a line  $AC$ , and at  $A$  construct an angle  $CAB$ , whose tangent equals  $f$ ; divide  $AC$  into any number of equal parts in  $D, E, F, \dots$  and draw  $PD, QE, RF, \dots BC$  at right angles to  $AC$ , then since  $PD = AD \times f, QE = AE \times f, RF = AF \times f, BC = AC \times f$ , etc.,  $PD$  will represent the velocity of the body at the end of the time represented by  $AD$ , and similarly  $QE, RF, \dots BC$ , will represent the velocity at the end of the times  $AE, AE, \dots AC$ . Complete the rectangles  $De, Ef, Fg, \dots$ . These rectangles represent the space described by the body on the above supposition during the second, third, fourth,  $\dots$  portions of the time. Consequently, the space actually described during the time  $AC$  is the limit of the sum of the rectangles ; the limit being continually approached as the number of parts into which  $AC$  is

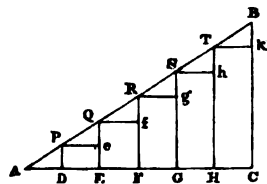

Fig. 29.

divided is continually increased. But this limit is the area of the triangle ABC : that is  $\frac{1}{2}AC \times CB$  or  $\frac{1}{2}AC \times AC \times f$ . Therefore, if AC represents the time  $t$  during which the body describes a space  $s$ , we have

$$s = \frac{1}{2}ft^2. \quad (2)$$

Since this equation can be written

$$2fs = f^2 t^2$$

we find, on comparing this with equation (1), that

$$v^2 = 2fs. \quad (3)$$

To illustrate these equations, let us suppose the accelerative effect of the force to be 6, that is to say, that in virtue of the action of the force, the body acquires in each successive second an additional velocity of 6 ft. per second, and let it be asked what, on the supposition of the body moving from rest will be the velocity acquired and the space described at the end of 12 seconds; equations 1 and 2 enable us to answer that at that instant it will be moving at the rate of 72 ft. per second and will have described 432 ft.

The following important result follows from equation 2. At the end of the first, second, third, fourth, etc. second of the motion the body will have described  $\frac{1}{2}f$ ,  $\frac{1}{2}f \times 4$ ,  $\frac{1}{2}f \times 9$ ,  $\frac{1}{2}f \times 16$ , etc., ft., and consequently during the first, second, third, fourth, etc. second of the motion will have described  $\frac{1}{2}f$ ,  $\frac{1}{2}f \times 3$ ,  $\frac{1}{2}f \times 5$ ,  $\frac{1}{2}f \times 7$ , etc., ft., namely, spaces in arithmetical progression.

The results of the above article can be stated in the form of laws which apply to the state of a body moving from a state of rest under the action of a constant force :—

I. *The velocities are proportional to the times during which the motion has lasted.*

II. *The spaces described are proportional to the squares of the times employed in their description.*

III. *The spaces described are proportional to the squares of the velocities acquired during their description.*

IV. *The spaces described in equal successive periods of time increase by a constant quantity.*

Instead of supposing the body to begin to move from a state of rest, we may suppose it to have an initial velocity  $V$ , in the direction of the force. In this case equations 1, 2, and 3 can be easily shown to take the following forms respectively :—

$$\begin{aligned} v &= V + ft, \\ s &= Vt + \frac{1}{2}ft^2 \\ v^2 &= V^2 + 2fs. \end{aligned}$$

If the body move in a direction opposite to that of the force,  $f$  must be reckoned negative.

The most important exemplification of the laws stated in the present article is in the case of a body falling freely *in vacuo*. Here the force causing the acceleration is that of gravity, and the acceleration produced is denoted by the letter  $g$ ; it has already been stated (27 and 29) that the numerical value of  $g$  is 32.1912 at London, when the unit of time is a second and the unit of distance a foot. Adopting the metre as unit of distance the value of  $g$  at London is 9.8117.

50. **Motion on an Inclined Plane.**—Referring to (43), suppose the force  $P$  not to act ; then the mass  $M$  is acted on by an unbalanced force  $Mg \sin x$ , in the direction  $SR$ , consequently the accelerating force down the plane is  $g \sin x$ , and the motion becomes a particular case of that discussed in the last article. If it begins to move from rest, it will at the end of  $t$  seconds acquire a velocity  $v$  given by the equation

$$v = gt \sin x,$$

and will describe a length  $s$  of the plane given by the equation

$$s = \frac{1}{2}gt^2 \sin x.$$

Also, if  $v$  is the velocity acquired while describing  $s$  feet of the plane

$$v^2 = 2gs \sin x.$$

Hence (fig. 22) if a body slides down the plane from  $S$  to  $R$  the velocity which it acquires at  $R$  is equal to  $\sqrt{2g \cdot RS \sin R}$  or  $\sqrt{2g \cdot ST}$ ; that is to say, the velocity which the body has at  $x$  does not depend on the angle  $x$ , but only on the perpendicular height  $ST$ . The same would be true if for  $RS$  we substituted any smooth curve, and hence we may state generally, that when a body moves along any smooth line under the action of gravity, the change of velocity it experiences in moving from one point to another is that due to the vertical height of the former point above the latter.

51. **Motion of Projectiles.**—The equations given in the above article apply to the case of a body thrown vertically upwards or downwards with a certain initial velocity. We will now consider the case of a heavy body thrown in a horizontal direction. Let  $a$ , fig. 30, be such a body thrown with an initial velocity of  $v$  feet in a second, and let the line  $ab$  represent the space described in any interval; then, at the end of the 2, 3, 4 . . . equal interval, the body, in virtue of its inertia, will have reached the points  $c d e$ , &c. But, during all this time the body is under the influence of gravity which if it alone acted, would cause the body to fall through the distances represented on the vertical line; these are determined by the successive values of  $\frac{1}{2}gt^2$ , which is the formula for the space described by a freely falling body (fig. 49). The effect of the combined action of the two forces is that at the end of the first interval, &c., the body will be at  $b'$ , at the end of the second interval at  $c'$ , of the third at  $d'$ , &c., the spaces  $bb'$ ,  $cc'$ ,  $dd'$  . . . being proportional to the squares of  $ab$ ,  $ac$ ,  $ad$ , respectively, and the line joining these points represents the path of the body. By taking the intervals of time sufficiently small we get a regularly curved line of the form known as the *parabola*.

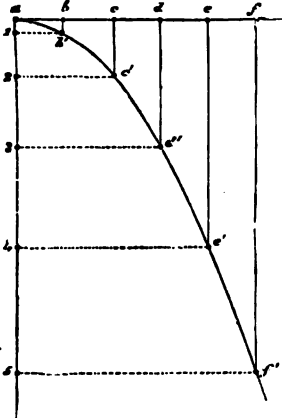

Fig. 30.

If the direction in which the body is thrown makes an angle of  $a$  with the horizon (fig. 31) then after  $t$  seconds it would have travelled a distance  $ab = vt$ , where  $v$  is the original velocity; during this time, however, it will have fallen through a distance  $bc = \frac{1}{2}gt^2$ ; the height which it will have actually

reached is  $=bd - bc = vt \sin a - \frac{1}{2}gt^2$ ; and the horizontal distance will be  $ad = ab \cos a = vt \cos a$ . The range of the body, or the greatest distance

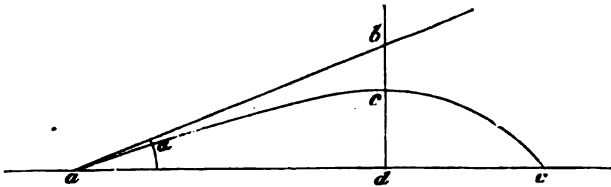

Fig. 31.

through which it is thrown, will be reached when the height is again  $= 0$ , that is, when  $vt \sin a - \frac{1}{2}gt^2 = 0$ , from which  $t = \frac{2v \sin a}{g}$ . Introducing this value of  $t$  into the equation for the distance  $d$ , we have  $d = \frac{2v^2 \sin a \cos a}{g}$ , which by a trigonometrical transformation  $= \frac{v^2 \sin 2a}{g}$ . The greatest height is attained in half the time of flight, or when  $t = \frac{v \sin a}{g}$  from which we get  $h = \frac{v^2 \sin^2 a}{2g}$ .

It follows from the formula that the height is greatest when  $\sin a$  is greatest, which is the case when it  $= 90^\circ$ , or when the body is thrown vertically upwards; the range is greatest where  $\sin 2a$  is a maximum, that is when  $2a = 90^\circ$  or  $a = 45^\circ$ .

In these formulæ it has been assumed that the air offers no resistance. This is, however, far from the case, and in practice, particularly if the velocity of projection is very great, the path differs from that of a parabola. Fig. 31 approximately represents the path, allowing for the resistance of the air. The divergence from the true theoretical path is the greater from the fact that in the modern rifled arms the shape of the projectiles are not spherical, and also because, along with their motion of translation, they have, in consequence of the rifling, a rotatory motion about their axis.

**52. Composition of Velocities.**—The principle for the composition of velocities is the same as that for the composition of forces: this follows evidently from the fact that forces are measured by the momentum they communicate, and are therefore to one another in the same ratio as the velocities they communicate to the *same* body. Thus (fig. 5, art. 33) if the point has at any instant a velocity AB, in the direction AP, and there is communicated to it a velocity AC in the direction AQ, it will move in the direction AR with a velocity represented by AD. And conversely, the velocity of a body represented by AD can be resolved into two component velocities AB and AC. This suggests the method of determining the motion of a body when acted on by a force in a direction transverse to the direction of its velocity; namely suppose the time to be divided into a great number of intervals, and suppose the velocity actually communicated by the force to be communicated at once, then by the composition of velocities we can determine the motion during each interval, and therefore during the whole time; the actual motion is the

limit to which the motion, thus determined, approaches when the number of intervals is increased.

**53. Motion in a Circle.—Centrifugal Force.**—When a body is once in motion, unless it be acted upon by some force, it will move uniformly forward in a straight line with unchanged velocity. If, therefore, a body moves uniformly in any other path than a straight line—in a circle, for instance—this must be because some force is constantly at work which continuously deviates it from this straight line.

We have already seen an example of this in the case of the motion of projectiles (51), and will now consider it in the case of central motion, or motion in a circle, of which we have an example in the motion of the celestial bodies or in the motion of a sling.

In the latter case, if the string is cut, the stone, ceasing to be acted upon by the tension of the string, will move in a straight line with the velocity which it already possesses, that is, in the direction of the tangent to the curve at the point where the stone was when the string was cut. The tension of the string, the effect of which is to pull the stone towards the centre of the circle, and to cause the stone to move in its circular path, is called the centripetal or central force; the reaction of the stone upon the string, which is equal and opposite to this force, is called its centrifugal force. The amount of these forces may be arrived at as follows:—

Let us suppose a body moving in a circle with given uniform velocity to be at the point  $a$ ; then, had it not been acted on by a force in the direction  $ac$ , it would, in a small succeeding interval of time  $t$ , have continued to move in the direction of the tangent at  $a$ , and have passed through a distance which we will represent by  $ab$ . In consequence, however, of this force it has not followed this direction, but has arrived at the point  $d$  on the curve; hence the force has made it traverse the distance  $bd = ac$  in this interval. If  $f$  be the accelerating force which draws the body towards the centre,  $ac = \frac{1}{2} ft^2$ , and if  $ad$  be very small, it may be taken as equal to  $ab$  or  $vt$ , where  $v$  is the velocity of the moving body. Now if  $an$  is the diameter of the circle, the triangle  $adn$  is inscribed in a semicircle and is right-angled, whence  $ad^2 = ac \times an = ac \times 2r$ . Substituting their values for  $ad$  and  $ac$  in this equation, we find that  $v^2 t^2 = \frac{1}{2} ft^2 \times 2r$ , from which  $f = \frac{v^2}{r}$ ; that is, in order that a body, with a

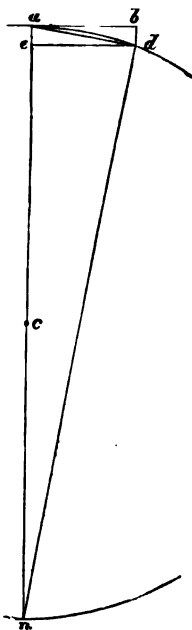

Fig. 32.

certain velocity may move in a circle, it must be drawn to the centre by a force which is directly as the square of the velocity with which the body moves, and which is inversely as the radius of the circle. In order to express this in the ordinary units of weight, we must multiply the above expression by the mass, which gives  $F = \frac{mv^2}{r}$  or  $\frac{W}{gr} v^2$ . To keep the body in a circle an attraction

towards the centre is needed, which is constantly equal to  $\frac{mv^2}{r}$ , and this attraction is constantly neutralised by the centrifugal force.

The above expression may be put in a form which is sometimes more convenient. If  $T$  be the time in seconds required to traverse the circumference  $2\pi r$  with the velocity  $v$ , then  $v^2 = \frac{4\pi^2 r^2}{T^2}$  from which  $F = \frac{4m\pi^2 r}{T^2} = \frac{4W\pi^2 r}{gT^2}$ .

If a rigid body rotates about a fixed axis, all parts of the body describe circumferences of various diameters, but all in the same time. The velocity of the motion of individual particles increases with the distance from the axis of rotation. By *angular velocity* is understood the velocity of a point at unit distance from the axis of rotation. If this is denoted by  $\omega$ , the velocity  $v$  of a point at a distance  $r$  from the axis is  $\omega r$ , from which  $\omega = \frac{v}{r} = \frac{2\pi}{T}$  and  $f = r\omega^2$ .

The existence of centrifugal force may be demonstrated by means of numerous experiments. If a small can of water hung by the handle to a string be rapidly rotated in a vertical circle, no water will fall out, for, at a suitable velocity, the liquid will press against the bottom of the vessel with a force at right angles to the circle, and greater than its own weight.

54. **Motion in a Vertical Circle.**—Let  $ACDB$  be a circle whose plane

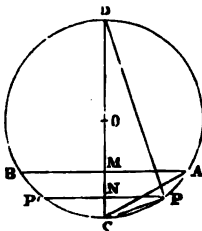

Fig. 33.

is vertical and radius denoted by  $r$ . Suppose a point placed at  $A$ , and allowed to slide down the curve, what velocity will it have acquired on reaching any given point  $P$ ? Draw the vertical diameter  $CD$ , join  $CA$ ,  $CP$ , and draw the horizontal lines  $AMB$  and  $PNP'$ . Now, assuming the curve to be smooth, the velocity acquired in falling from  $A$  to  $P$  is that due to  $MN$ , the vertical height of  $A$  above  $P$  (50); if, therefore,  $v$  denote the velocity of the point at  $P$ , we shall have

$$v^2 = 2g MN.$$

Now by similar triangles  $DCP$ ,  $PCN$  we have

$$DC : CP :: CP : CN$$

consequently, if we denote by  $s$  the chord  $CP$ ,

$$2r NC = s^2$$

in like manner if  $a$  denote the chord  $CA$ ,

$$2r MC = a^2$$

therefore

$$2r MN = a^2 - s^2$$

and

$$v^2 = \frac{g}{r} (a^2 - s^2).$$

Now  $v$  will have equal values when  $s$  has the same value, whether positive or negative, and for any one value of  $s$  there are two equal values of  $v$ , one positive and one negative. That is to say, since  $CP'$  is equal to  $CP$ , the body will have the same velocity at  $P'$  that it has at  $P$ , and at any point the body will have the same velocity whether it is going up the curve or down the curve. Of course it is included in this statement that if the body begins

to move from A it will just ascend to a point B on the other side of C, such that A and B are in the same horizontal line. It will also be seen that at C the value of  $s$  is zero; consequently, if  $V$  is the velocity acquired by the body in falling from A to C we have

$$V = a \sqrt{\frac{g}{r}};$$

and, on the other hand, if the body begins to move from C with a velocity  $V$  it will reach a point A such that the chord  $AC$  or  $a$  is given by the same equation. In other words, the velocity at the lowest point is proportional to the chord of the arc described.

**55. Motion of a Simple Pendulum.**—By a simple pendulum is meant a heavy particle suspended by a fine thread from a fixed point, about which it oscillates without friction. So far as its changes of velocity are concerned they will be the same as those of the point in the previous article, for the tension of the thread, acting at each position in a direction at right angles to that of the motion of the point, will no more affect its motion than the reaction of the smooth curve affects that of the point in the last article. The time of an oscillation, that is, the time in which the point moves from A to B, can be easily ascertained when the arc of vibration is small, that is, when the chord and the arc do not sensibly differ.

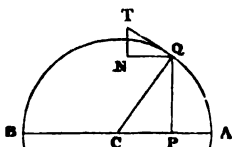

Fig. 34.

Thus, let  $AB$  (fig. 34) equal the arc or chord  $ACB$  (fig. 33), with centre  $C$  and radius  $AC$  or  $a$  describe a circle, and suppose a point to describe the circumference of that circle with a uniform velocity  $V$  or  $a \sqrt{\frac{g}{r}}$ . At any instant let the point be at  $Q$ , join  $CQ$ , draw the tangent  $QT$ , also draw  $QP$  at right angles and  $QN$  parallel to  $AB$ , then the angles  $NQT$  and  $CQP$  are equal. Now the velocity of  $Q$  resolved parallel to  $AB$  is  $V \cos TQN$  or  $a \sqrt{\frac{g}{r}} \cos CQP$ , that is, if  $CP$  equals  $s$ , the velocity of  $Q$  parallel to  $AB$  is

$$\sqrt{\frac{g}{r}} PQ \text{ or } \sqrt{\frac{g}{r}} (a^2 - s^2).$$

But if we suppose a point to move along  $AB$  in such a manner that its velocity in each position is the same as that of the oscillating body, its velocity at  $P$  would also equal  $\sqrt{\frac{g}{r}} (a^2 - s^2)$ ; and, therefore, this point would describe  $AB$  in the same time that  $Q$  describes the semicircumference  $AQB$ . If then  $t$  be the required time of an oscillation we have

$$t = \pi a + a \sqrt{\frac{g}{r}} = \pi \sqrt{\frac{r}{g}}.$$

This result is independent of the length of the arc of vibration, provided its *amplitude*, that is  $AB$ , be small—not exceeding 4 or 5 degrees, for instance. It is evident from the formula that the time of a vibration is directly pro-



portional to the square root of the length of the pendulum, and inversely proportional to the square root of the accelerating force of gravity.

As an example of the use of the formula we may take the following :— It has been found that 39·13983 inches is the length of a simple pendulum, whose time of oscillation at Greenwich is one second ; the formula at once leads to an accurate determination of the accelerating force of gravity  $g$  ; for using feet and seconds as our units we have  $t = 1$ ,  $r = 3·26165$ , and  $\pi$  stands for the known number 3·14159, therefore the formula gives us

$$g = (3·14159)^2 \times 3·26165 = 32·1912.$$

This is the value employed in (29).

Other examples will be met with in the Appendix.

56. **Graphic Representation of the Changes of Velocity of an Oscillating Body.**—The changes which the velocity of a vibrating body undergoes may be graphically represented as follows : draw a line of indefinite length and mark off AH to represent the time of one vibration. HH' to represent the time of the second vibration, and so on. During the first vibration the

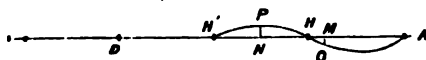

Fig. 35.

velocity increases from zero to a maximum at the half vibration, and then decreases during the second half vibration from the maximum to zero. Consequently, a curved line or arc AQH may be drawn, whose ordinate QM at any point Q will represent the velocity of the body at the time represented by AM. If a similar curved line or arc HPH' be drawn, the ordinate PN of any point P will represent the velocity at a time denoted by AN. But since the *direction* of the velocity in the second oscillation is contrary to that of the velocity in the first oscillation, the ordinate NP must be drawn in the contrary direction to that of MQ. If, then, the curve be continued by a succession of equal arcs alternately on opposite sides of AD, the variations of the velocity of the vibrating body will be completely represented by the varying magnitudes of the ordinates of successive points of the curve. The last article shows this to be the curve of sines for a pendulum.

57. **Conical Pendulum.**—When a point P is suspended from a point A as a simple pendulum, it can be caused to describe a horizontal circle with a uniform velocity V. A point moving in such a manner constitutes what is called a *conical pendulum*, and admits of many useful and interesting applications. We will, in this place, ascertain the relation which exists between the length  $r$  of the thread, AP, the angle of the cone PAN or  $\theta$ , and the velocity V. Since the point P moves in a circle whose radius is PN, with a velocity V, a force R must act on it in the direction PN given by the equation (53)

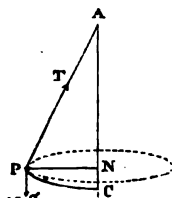

Fig 36

$$R = M \frac{V^2}{PN}$$

Now the only forces acting are the tension of the thread T along PA,

and the weight of the body  $Mg$  vertically, consequently their resultant must be a force  $R$  acting along  $PN$ . And therefore these forces will be parallel to the sides of the triangle  $ANP$ , so that (35)

$$R = Mg \frac{PN}{AN},$$

therefore

$$M \frac{V^2}{PN} = Mg \frac{PN}{AN},$$

or

$$V^2 = g \frac{PN^2}{AN}.$$

Now

$$FN = r \sin \theta \text{ and } \frac{PN}{AN} = \tan \theta,$$

therefore

$$V^2 = gr \sin \theta \tan \theta.$$

One conclusion from this may be noticed. With centre  $A$  and radius  $AP$ , describe the arc  $PC$ . Now when the angle  $PAC$  is small, the sine,  $PN$ , does not sensibly differ from the chord, nor the cosine,  $AN$ , from the radius, therefore in this case we have

$$V^2 = g \cdot \frac{(\text{chd } PC)^2}{\text{radius}} \text{ or } V = \text{chd } PC \sqrt{\frac{g}{r}}.$$

On comparing this result with (54) we see that when the angle  $PAN$  is small, the velocity of  $P$  moving in a conical pendulum is the same as  $P$  would have at the lowest point  $C$  if it oscillated as a simple pendulum; consequently, if we conceive the point  $P$  to be making small oscillations about the point  $A$ , and denote the velocity at the lowest point by  $V$ , and if, when at the extreme point of the arc of vibration, there is communicated to it a velocity  $V$  in a direction at right angles to the plane of vibration, its motion will be changed into that of a conical pendulum.

**58. Impulsive Forces.**—When a force acts on a body for an inappreciable short time, and yet sensibly changes its velocity, it is termed an *instantaneous* or *impulsive* force. Such a force is called into play when one body strikes against another. A force of this character is nothing but a finite though very large force, acting for a time so short that its duration is nearly or quite, insensible. In fact, if  $M$  is the mass of the body, and the force contains  $Mf$  units, it will, in a time  $t$ , communicate a velocity  $ft$ ; now, however small  $t$  may be,  $Mf$  and therefore  $f$  may be so large that  $ft$  may be of sensible or even considerable magnitude. Thus if  $M$  contain a pound of matter, and if the force contain ten thousand units, though  $t$  were so short as to be only the  $\frac{1}{1000}$ th of a second, the velocity communicated by the force would be one of 10 ft. per second. It is also to be remarked that the body will not sensibly move while this velocity is being communicated; thus, in the case supposed, the body would only move through  $\frac{1}{2}ft^2$  or the  $\frac{1}{200}$ th of a foot while the force acts upon it.

When one body impinges on another it follows from the law of the equality of action and reaction (39) that whatever force the first body exerts upon the second, the second will exert an equal force upon the first in the

opposite direction ; now forces are proportional to the momenta generated in the same time ; consequently, these forces generate, during the whole or any part of the time of impact, in the bodies respectively, equal momenta with contrary signs ; and therefore the sum of the momenta of the two bodies will remain constant during and at the end of the impact. It is of course understood that if the two bodies move in contrary directions their momenta have opposite signs and the sum is an algebraical sum. In order to test the physical validity of this conclusion, Newton made a series of experiments, which may be briefly described thus :—Two balls A and B are hung from points C, D, in the same horizontal line by threads in such a manner that

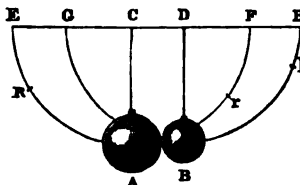

Fig. 37.

their centres A and B are in the same horizontal line. With centre C and radius CA describe a semicircle EAF, and with centre D and radius DB describe a semicircle GBH on the wall in front of which the balls hang. Let A be moved back to R, and be allowed to descend to A ; it there impinges on B, both A and B will now move, along the arch AF and BH respectively ; let A and B come to their highest points at  $r$  and  $k$  respectively.

Now if  $V$  denote the velocity with which A reaches the lowest point,  $v$  and  $u$  the velocities with which A and B leave the lowest points after impact, and  $r$  the radius AC, it appears from (54) that

$$V = \text{chd } AR \sqrt{\frac{g}{r}}, \quad v = \text{chd } Ar \sqrt{\frac{g}{r}}, \quad \text{and } u = \text{chd } Bk \sqrt{\frac{g}{r}}$$

therefore if A and B are the masses of the two balls, the momentum at the instant before impact was  $A \times \text{chd } AR$  and the momentum after impact was  $A \times \text{chd } Ar + B \times \text{chd } Bk$ . Now when the positions of the points R,  $r$ , and  $k$  had been properly corrected for the resistance of the air, it was found that these two expressions were equal to within quantities so small that they could be properly referred to errors of observation. The experiment succeeded equally under every modification, whether A impinged on B at rest or in motion, and whatever the materials of A and B might be.

**59. Direct Collision of Two Bodies.**—Let A and B be two bodies moving with velocities  $V$  and  $U$  respectively, along the same line, and let their mutual action take place in that line ; if the one overtake the other, what will be their respective velocities at the instant after impact ? We will answer this question in two extreme cases.

i. Let us suppose the bodies to be *quite inelastic*. In this case, when A touches B, it will continue to press against B until their velocities are equalised, when the mutual action ceases. For whatever deformation the bodies may have undergone, they have no tendency to recover their shapes. If, therefore,  $x$  is their common velocity after impact, we shall have  $Ax + Bx$  their joint momentum at the end of impact, but their momentum before impact was  $AV + BU$ . Whence

$$(A + B)x = AV + BU,$$

an equation which determines  $x$ .

ii. Let us suppose the bodies *perfectly elastic*. In this case they recover

their shapes, with a force exactly equal to that with which they were compressed. Consequently, the whole momentum lost by the one, and gained by the other, must be exactly double of that lost while compression took place, that is, up to the instant at which their velocities were equalised. But these are respectively  $AV - Ax$  and  $Bx - BU$ ; therefore, if  $v$  and  $u$  are the required final velocities,

$$Av = AV - 2(AV - Ax) \text{ or } v = -V + 2x$$

$$Bu = BU + 2(Bx - BU) \text{ or } u = 2x - U$$

hence

$$(A + B)v = 2BU + (A - B)V$$

and

$$(A + B)u = 2AV - (A - B)U.$$

The following conclusion from these equations may be noticed: suppose a ball A, moving with a velocity  $V$ , to strike directly an equal ball B at rest. In this case  $A = B$ , and  $U = 0$ , consequently  $v = 0$  and  $u = V$ , that is, the former ball A is brought to rest, and the latter B moves on with a velocity  $V$ . If now B strike on a third equal ball C at rest, B will in turn be brought to rest, and C will acquire the velocity  $V$ . And the same is true if there is a fourth, or fifth, or indeed any number of balls. This result may be shown with ivory balls, and if carefully performed is a very remarkable experiment.

**Go. Work: Meaning of the Term.**—It has been pointed out (19, 26) that a moving body has no power of itself to change either the direction or the speed of its motion, and that, if any such change takes place, it is a proof that the body is acted upon by some external force. But although change of motion thus always implies the action of force, forces are often exerted without causing any change in the motion of the bodies on which they act. For instance, when a ship is sailing at a uniform speed the force exerted on it by the wind causes no change in its motion, but simply prevents such a change being produced by the resistance of the water; or, when a railway-train is running with uniform velocity, the force of the engine does not change, but only maintains its motion in opposition to the forces, such as friction and the resistance of the air, which tend to destroy it.

These two classes of cases, namely, first, those in which forces cause a change of motion; and secondly, those in which they prevent, wholly or in part, such a change being produced by other forces, include all the effects to which the action of forces can give rise. When acting in either of these ways, a force is said to *do work*: an expression which is used scientifically in a sense somewhat more precise, but closely accordant with that in which it is used in common language. A little reflection will make it evident that, in all cases in which we are accustomed to speak of work being done—whether by men, horse-power, or steam-power, and however various the ducts may be in different cases—the physical part of the process consists solely in producing or changing motion, or in keeping up motion in opposition to resistance, or in a combination of these actions. The reader will easily convince himself of this by calling to mind what the definite actions are which constitute the work done by (say) a navvy, a joiner, a mechanic, a weaver; that done by a horse, whether employed in drawing a vehicle or in turning a gin; or that of a steam-engine, whether it be used to drag a railway-train or to drive machinery. In all cases the work done is reducible, from a mechanical

point of view, to the elements that have been mentioned, although it may be performed on different materials, with different tools, and with different degrees of skill.

It is, moreover, easy to see (comp. 52) that any possible change of motion may be represented as a gain by the moving body of an additional (positive or negative) velocity either in the direction of its previous motion, or at right angles to it; but a body which gains velocity is (27) said to be *accelerated*. Hence, what has been said above may be summed up as follows:—*When a force produces acceleration, or when it maintains motion unchanged in opposition to resistance, it is said to do WORK.*

61. **Measure of Work.**—In considering how work is to be measured, or how the relation between different quantities of work is to be expressed numerically, we have, in accordance with the above, to consider first, *work of acceleration*; and secondly, *work against resistance*. But in order to make the evaluation of the two kinds of work consistent, we must bear in mind that one and the same exertion of force will result in work of either kind according to the conditions under which it takes place: thus, the force of gravity acting on a weight let fall from the hand causes it to move with a continually accelerated velocity until it strikes the ground; but if the same weight, instead of being allowed to fall freely through the air, be hung to a cord passing round a cylinder by means of which various degrees of friction can be applied to hinder its descent, it can be made to fall with a very small and practically uniform velocity. Hence, speaking broadly, it may be said that, in the former case, the work done by gravity upon the weight is work of acceleration only, while in the latter case it is work against resistance (friction) only. But it is very important to note that an essential condition, without which a force, however great, cannot do work either of one kind or the other, is that the thing acted on by it shall *move* while the force continues to act. This is obvious, for if no motion takes place it clearly cannot be either accelerated or maintained against resistance. The motion of the body on which a force acts being thus necessarily involved in our notion of work being done by the force, it naturally follows that, in estimating how much work is done, we should consider how much—that is to say, how far—the body moves while the force acts upon it. This agrees with the mode of estimating quantities of work in common life, as will be evident if we consider a very simple case, for instance, that of a labourer employed to carry bricks up to a scaffold: in such a case a double number of bricks carried would represent a double quantity of work done, but so also would a double height of the scaffold, for whatever amount of work is done in raising a certain number to a height of twenty feet, the same amount must be done again to raise them another twenty feet, or the amount of work done in raising the bricks forty feet is twice as great as that done when they are raised only twenty feet. It is also to be noted that no direct reference to *time* enters into the conception of a quantity of work? if we want to know how much work a labourer has done, we do not ask how long he has been at work, but what he has done—for instance, how many bricks he has carried, and to what height;—and our estimate of the total amount of work is the same whether the man has spent hours or days in doing it.

The foregoing relations between force and work may be put into definite

mathematical language as follows :—If the point of application of a force moves in a straight line, and if the part of the force resolved along this line acts in the direction of the motion, the product of that component and the length of the line is the work done by the force. If the component acts in the opposite direction to the motion, the component may be considered as a resistance and the product is work done against the resistance. Thus, in (43) if we suppose  $\alpha$  to move up the plane from R to S, the work done by P is  $P \times RS$ ; the work done against the resistance W is  $W \sin x \times RS$ . It will be observed that if the forces are in equilibrium during the motion, so that the velocity of  $\alpha$  is uniform, P equals  $W \sin x$ , and consequently the work done by the power equals that done against the resistance. Also since  $RS \sin x$  equals ST, the work done against the resistance equals  $W \times ST$ . In other words, to raise W from R to S requires the same amount of work as to raise it from T to S.

If, however, the forces are not in equilibrium, the motion of  $\alpha$  will not be uniform, but accelerated; the work done upon it will nevertheless still be represented by the product of the force into the distance through which it acts. In order to ascertain the relation between the amount of work done and the change produced by it in the velocity of the moving mass, we must recall one or two elementary mechanical principles. Let F be the resultant force resolved along the direction of motion, and S the distance through which its point of application moves: then, according to what has been said, the work done by the force = FS. Further, it has been pointed out (29), that a constant force is measured by the momentum produced by it in a unit of time: hence, if T be the time during which the force acts, V the velocity of the mass M at the beginning of this period, and  $V_1$  the velocity at the end of it, the momentum produced during the time T is  $MV_1 - MV$ , and consequently the momentum produced in a unit of time, or, in other words, the measure of the force is

$$F = \frac{M(V_1 - V)}{T}.$$

The distance S through which the mass M moves while its velocity changes from the value V to the value  $V_1$ , is the same as if it had moved during the whole period T with a velocity equal to the average value of the varying velocity which it actually possesses. But a constant force acting upon a constant mass causes its velocity to change at a uniform rate; hence, in the present case, the average velocity is simply the arithmetical mean of the initial and final velocities, or

$$S = \frac{1}{2}(V_1 + V)T.$$

Combining this with the last equation, we get as the expression for the work done by the force F—

$$FS = \frac{1}{2}M(V_1^2 - V^2);$$

or, in words, *when a constant force acts on a mass so as to change its velocity, the work done by the force is equal to half the product of the mass into the change of the square of the velocity.*

The foregoing conclusion has been arrived at by supposing the force F to be constant, but it is easy to show that it holds good equally if F is the *average* magnitude of a force which varies from one part to another of the

total distance through which it acts. To prove this, let the distance  $S$  be subdivided into a very great number  $n$  of very small parts each equal to  $s$ , so that  $n s = S$ . Then, by supposing  $s$  to be sufficiently small, we may without any appreciable error consider the force as constant within each of these intervals and as changing suddenly as its point of application passes from one interval to the next. Let  $F_1, F_2, F_3, \dots, F_n$ , be the forces acting throughout the 1st, 2nd, 3rd  $\dots$   $n$ th interval respectively, and let the velocity at the end of the same intervals be  $v_1, v_2, v_3, \dots, v_n (= V_1)$  respectively; then, for the work done in the successive intervals, we have—

$$F_1 s = \frac{1}{2} M (v_1^2 - V_0^2)$$

$$F_2 s = \frac{1}{2} M (v_2^2 - v_1^2)$$

$$F_3 s = \frac{1}{2} M (v_3^2 - v_2^2)$$

$$\vdots$$

$$\vdots$$

$$\vdots$$

$$F_n s = \frac{1}{2} M (v_n^2 - v_{n-1}^2) = \frac{1}{2} M (V_1^2 - v_{n-1}^2),$$

or, for the total work,

$$(F_1 + F_2 + F_3 + \dots + F_n) s = \frac{1}{2} M (V_1^2 - V_0^2);$$

where the quantity on the left-hand side of the equation may also be written

$\frac{F_1 + F_2 + \dots + F_n}{n} n s = FS$ , if we put  $F$  to stand for the average (or

arithmetical mean) of the forces  $F_1, F_2$ , etc.

An important special case of the application of the above formula arises when either the initial or the final velocity of the mass  $M$  is nothing, that is to say, when the effect of the force is to make a body pass from a state of rest into one of motion, or from a state of motion into one of rest. The general expression then assumes one of the following forms, namely:—

$$F S = \frac{1}{2} M V_1^2 \text{ or,}$$

$$- F S = \frac{1}{2} M V^2;$$

the first of which denotes the quantity of work which must be done on a body of mass  $M$  in order to give to it the velocity  $V_1$ , while the second expresses the work that must be done in order to bring the same mass to rest when it is moving with the velocity  $V$ , the negative sign in the latter case showing that the force here acts *in opposition* to the actual motion, and is therefore to be regarded as a resistance.

In practice, the case which most frequently occurs is where work of acceleration and work against resistance are performed simultaneously. Thus, recurring to the inclined plane already referred to in art. 43; if the force  $P$  (where  $P$  is the constant force with which the string pulls  $W$  up the plane) be greater than  $W \sin x$ , the body  $W$  will move up the incline with a continually increasing velocity, and if the point of application of  $P$  be displaced from  $R$  to  $S$ , the total amount of work done, namely,  $P \times RS$ , consists of a portion =  $W \sin x RS$ , done against the resistance of the weight  $W$ , and of a portion =  $(P - W \sin x) RS$  expended in accelerating the weight. Hence, to determine the velocity  $v$  with which  $W$  arrives at the top of the incline we have the equation

$$(P - W \sin x) RS = \frac{1}{2} W v^2;$$

for the portion of P which is in excess of what is required to produce equilibrium with the weight W, namely,  $P - W \sin x$ , corresponds to the resultant force F supposed in the foregoing discussion, and RS to the distance through which this resultant force acts.

62. **Unit of Work.**—For strictly scientific purposes a unit of work is taken to be the work done by a unit of force when its point of application moves through one foot in the direction of its action; but, as a convenient and sufficiently accurate standard for practical purposes, the quantity of work which is done in lifting 1 pound through the height of 1 foot is commonly adopted as the unit, and this quantity of work is spoken of as one 'foot-pound.' It is, however, important to observe that the foot-pound is not perfectly invariable, since the weight of a pound, and therefore the work done in lifting it through a given height, differs at different places; being a little greater near the poles than near the Equator.

63. **Energy.**—The fact that any agent is capable of doing work is usually expressed by saying that it possesses *Energy*, and the quantity of energy it possesses is measured by the amount of work it can do. For example, in the case of the inclined plane above referred to, the working power or energy of the force P is  $P \times RS$ ; and if this force acts under the conditions last supposed, by the time its own energy is exhausted (in consequence of its point of application having arrived at B, the limit of the range through which it is supposed able to act), it has conferred upon the weight W a quantity of energy equal to that which has been expended; for, in the first place, W has been raised through a vertical height equal to ST, and could by falling again through the same height do an amount of work represented by  $W \times ST$ ; and in the second place W can do work by virtue of the velocity that has been imparted to it, and can continue moving in opposition to any given resistance R through a distance s, such that

$$Rs = \frac{1}{2} Wv^2.$$

The energy possessed by the mass M in consequence of having been raised from the ground is commonly distinguished as *energy of position* or *potential energy*, and is measured by the product of the force tending to cause motion into the distance through which the point of application of the force is capable of being displaced in the direction in which the force acts. The energy possessed by a body in consequence of its velocity, is commonly distinguished as *energy of motion* or *kinetic energy*: it is measured by half the product of the moving mass into the square of its velocity.

64. **Varieties of Energy.**—It will be seen, on considering the definition of *work* given above, that a force is said to do work when it produces any change in the condition of bodies; for the only changes which, according to the definition of *force* given previously (26), a force is capable of producing, are changes in the state of rest or motion of bodies and changes of their place in opposition to resistances tending to prevent motion or to produce motion in an opposite direction. There are, however, many other kinds of physical changes which can be produced under appropriate conditions, and the recent progress of investigation has shown that the conditions under which changes of all kinds occur are so far analogous to those required for the production of work by mechanical forces that the term *work* has come



to be used in a more extended sense than formerly, and is now often used to signify the production of any sort of physical change.

Thus work is said to be done when a body at a low temperature is raised to a higher temperature, just as much as when a weight is raised from a lower to a higher level ; or again, work is done when any electrical, magnetic, or chemical change is produced. This extension of the meaning of the term work involves a similar extension of the meaning of *energy*, which in this wider sense may be defined as the *capacity for producing physical change*.

As examples of energy in this more general sense the following may be mentioned : (*a*) the energy possessed by gunpowder in virtue of the mutual chemical affinities of its constituents, whereby it is capable of doing work by generating heat or by acting on a cannon-ball so as to change its state of rest into one of rapid motion ; (*b*) the energy of a charged Leyden jar which, according to the way in which the jar is discharged, can give rise to changes of temperature, changes of chemical composition, to mechanical changes, or to changes of magnetic or electrical condition ; (*c*) the energy of a red-hot ball which, amongst other effects it is capable of producing, can raise the temperature and increase the volume of bodies colder than itself, or can change ice into water or water into steam.

**65. Transformations of Energy.**—It has been found by experiment that when one kind of energy disappears or is expended, energy of some other kind is produced, and that, under proper conditions, the disappearance of any one of the known kinds of energy can be made to give rise to a greater or less amount of any other kind. One of the simplest illustrations that can be given of this transformation of energy is afforded by the oscillations of a pendulum. When the pendulum is at rest in its lowest position it does not possess any energy, for it has no power of setting either itself or other bodies in motion or of producing in them any kind of change. In order to set the pendulum oscillating, work must be done upon it, and it thereafter possesses an amount of energy corresponding to the work that has been expended. When it has reached either end of its path, the pendulum is for an instant at rest, but it possesses energy by virtue of its position, and can do an amount of work while falling to its lowest position which is represented by the product of its weight into the vertical height through which its centre of gravity descends. When at the middle of its path the pendulum is passing through its position of equilibrium and has no power of doing work by falling lower ; but it now possesses energy by virtue of the velocity which it has gained, and this energy is able to carry it up on the second side of its lowest position to a height equal to that from which it has descended on the first side. By the time it reaches this position the pendulum has lost all its velocity, but it has regained the power of falling : this, in its turn, is lost as the pendulum returns again to its lowest position, but at the same time it regains its previous velocity. Thus during every quarter of an oscillation, the energy of the pendulum changes from potential energy of position, into actual energy of motion, or *vice versa*.

A more complex case of the transformation of energy is afforded by a thermo-electric pile, the terminals of which are connected by a conducting wire : the application of energy in the form of heat to one face of the pile gives rise to an electric current in the wire, which, in its turn, reproduces

heat, or by proper arrangements can be made to produce chemical, magnetic, or mechanical effects, such as those described below in the chapters on Electricity.

It has also been found that the transformations of energy always take place according to fixed proportions. For instance, when coal or any other combustible is burned, its chemical energy, or power of combining with oxygen vanishes, and heat or thermal energy is produced, and the quantity of heat produced by the combustion of a given amount of coal is fixed and invariable. If the combustion take place under the boiler of a steam-engine, mechanical work can be obtained by the expenditure of part of the heat produced, and here again the quantitative relation between the heat expended and the work gained in place of it is perfectly constant.

**66. Conservation of Energy.** [Another result of great importance which has been arrived at by experiment is that the total amount of energy possessed by any system of bodies is unaltered by any transformations arising from the action of one part of the system upon another, and can only be increased or diminished by effects produced on the system by external agents.] In this statement it is of course understood that in reckoning the sum of the energy of various kinds which the system may possess, those amounts of the different forms of energy which are mutually convertible into each other are taken as being numerically equal; or, what comes virtually to the same thing, the total energy of the system is supposed to be reduced—either actually, or by calculation from the known ratio of transformation of the various forms of energy—to energy of some one kind; then the statement is equivalent to this: that the total energy of any one form to which the energy of a given system of bodies is reducible is unalterable so long as the system is not acted on from without. Practically it is always possible, in one way or another, to convert the whole of the energy possessed by any body or system of bodies into heat, but it cannot be all converted without loss into any other form of energy; hence the principle stated at the beginning of this article can be enunciated in the closest conformity with the direct results of experiment by saying that, so long as any system of bodies is not acted on from without, the total quantity of heat that can be obtained from it is unalterable by any changes which may go on within the system itself. For instance, a quantity of air compressed into the reservoir of an air-gun possesses energy which is represented partly by the heat which gives to it its actual temperature above the absolute zero (460), and partly by the work which the air can do in expanding. This latter portion can be converted into heat in various ways, as, for example, by allowing the air to escape through a system of capillary tubes, so fine that the air issues from them without any sensible velocity; if, however the expanding air be employed to propel a bullet from the gun, it produces considerably less heat than in the case previously supposed, the deficiency being represented for a time by the energy of the moving bullet, but reappearing in the form of heat in the friction of the bullet against the air, and when the motion of the bullet is destroyed, by striking against an inelastic obstacle at the same level as the gun. But whatever the mode and however numerous the intermediate steps by which the energy of the compressed air is converted into heat, the total quantity of heat finally obtainable from it is the same.

## BOOK II.

## GRAVITATION AND MOLECULAR ATTRACTION.

## CHAPTER I.

## GRAVITY, CENTRE OF GRAVITY, THE BALANCE.

67. **Universal Attraction, its Laws.**—*Universal attraction* is a force in virtue of which the material particles of all bodies tend incessantly to approach each other; it is a mutual action, however, which all bodies, at rest or in motion, exert upon one another, no matter how great or how small the space between them may be, or whether this space be occupied or unoccupied by other matter.

A vague hypothesis of the tendency of the matter of the earth and stars to a common centre was adopted even by Democritus and Epicurus. Kepler assumed the existence of a mutual attraction between the sun, the earth, and the other planets. Bacon, Galileo, and Hooke also recognised the existence of universal attraction. But Newton was the first who established the law and the universality of gravitation.

Since Newton's time the attraction of matter by matter was experimentally established by Cavendish. This eminent English physicist succeeded by means of a delicate torsion balance (8) in rendering visible the attraction between a large leaden and a small copper ball.

The attraction between any two bodies is the resultant of the attractions of each molecule of the one upon every molecule of the other according to the law of Newton, which may be thus expressed: *the attraction between two material particles is directly proportional to the product of their masses and inversely proportional to the square of their distances asunder.* To illustrate this, we may take the case of two spheres which, owing to their symmetry, attract each other just as if their masses were concentrated in their centres. If without other alteration the mass of one sphere were doubled, tripled, etc., the attraction between them would be doubled, tripled, etc. If, however, the mass of one sphere being doubled, that of the other were increased three times, the distance between their centres remaining the same, the attraction would be increased six times. Lastly, if, without altering their masses, the distance between their centres were *increased* from 1 to 2, 3, 4, . . . . units, the attraction would be *diminished* to the 4th, 9th, 16th, . . . . part of its former intensity. In short, if we define the unit of attraction as that which would exist between two units of mass

whose distance asunder was the unit of length, the attraction of two molecules, having the masses  $m$  and  $m'$ , at the distance  $r$ , would be expressed by  $\frac{m m'}{r^2}$ .

68. **Terrestrial gravitation.**—The tendency of any body to fall towards the earth is due to the mutual attraction of that body and the earth, or to terrestrial gravitation, and is, in fact, merely a particular case of universal gravitation.

At any point of the earth's surface, the direction of gravity, that is the line which a falling body describes, is called the *vertical* line. The vertical lines drawn at different points of the earth's surface converge very nearly to the earth's centre. For points situated on the same meridian the angle contained between the vertical lines equals the difference between the latitudes of those points.

The directions of the earth's attraction upon neighbouring bodies, or upon different molecules of one and the same body, must, therefore, be considered as parallel, for the two vertical lines form the sides of a triangle whose vertex is near the earth's centre, about 4,000 miles distant, and whose base is the small distance between the molecules under consideration.

A plane or line is said to be *horizontal* when it is perpendicular to the vertical line.

The vertical line at any point of the globe is generally determined by the *plumb-line* (fig. 38), which consists of a weight attached to the end of a string. It is evident that the weight cannot be in equilibrium, unless the direction of the earth's attraction upon it passes through the point of support, and therefore coincides with that of the string.

The horizontal plane is also determined with great ease, since it coincides, as will be afterwards shown, with the *level* surface of every liquid when in a state of equilibrium.

When the mean figure of the earth has been approximately determined, it becomes possible to compare the direction of the plumb-line at any place with that of the normal to the mean figure at that place. When any difference in these directions can be detected, it constitutes a *deviation* of the plumb-line, and is due to the attraction of some great mass of matter in the neighbourhood, such as a mountain. Thus, in the case of the mountain of Schehallien, in Perthshire, it was found by Dr. Maskelyne that the angle between the directions of two plumb-lines, one at a station to the north, and the other to the south of the mountain, was greater by  $11''6$  than the angle between the normals of the mean surface of the earth at those points; in other words, each plumb-line was deflected by about  $6''$  towards the mountain. By calculating the volume and mass of the mountain, it was inferred from this observation that the mean density of the mountain was to that of the earth in the ratio of 5 : 9, and that the mean density of the earth is about five times that of water—a result agreeing pretty closely with that deduced from Cavendish's experiments referred to in the last article.



Fig. 38.

69. **Centre of gravity, its experimental determination.**—Into whatever position a body may be turned with respect to the earth, there is a certain point, invariably situated with respect to the body, through which the resultant of the attracting forces between the earth and its several molecules always passes. This point is called the *centre of gravity*; it may be within or without the body, according to the form of the latter; its existence, however, is easily established by the following considerations: Let  $m m' m''$

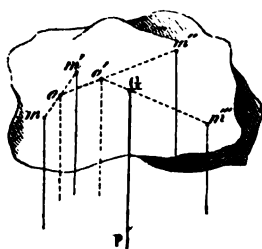

Fig. 39.

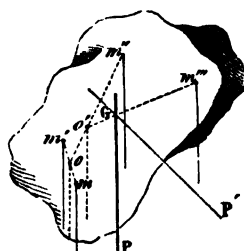

Fig. 40.

$m''$  . . (fig. 39) be molecules of any body. The earth's attraction upon these molecules will constitute a system of parallel forces, having a common vertical direction, whose resultant, according to (36) will be found by seeking first the resultant of the forces which act on any two molecules,  $m$  and  $m'$ , then that of this resultant, and a third force acting on  $m''$ , and so on until we arrive at the final resultant,  $W$ , representing the weight of the body, and applied at a certain point,  $G$ . If the body be now turned into the position shown in fig. 40, the molecules  $m, m', m''$  . . . will continue to be acted on by the same forces as before, the resultant of the forces on  $m$  and  $m'$  will still pass through the same point  $o$  in the line  $mm'$ , the following resultant will again pass through the same point  $o'$  in  $om''$ , and so on up to the final resultant  $P$ , which will still pass through the same point  $G$ , which is the *centre of gravity*.

To find the centre of gravity of a body is a purely geometrical problem; in many cases, however, it can be at once determined. For instance, the centre of gravity of a right line of uniform density is the point which bisects its length; in the circle and sphere it coincides with the geometrical centre; in cylindrical bars it is the middle point of the axis. The centre of gravity of a plane triangle is in the line which joins any vertex with the middle of the opposite side, and at a distance from the vertex equal to two thirds of this line: in a cone or pyramid it is in the line which joins the vertex with the centre of gravity of the base, and at a distance from the vertex equal to three-fourths of this line. These rules, it must be remembered, presuppose that the several bodies are of uniform density.

In order to determine experimentally the centre of gravity of a body, it is suspended by a string in two different positions, as shown in figs. 41 and 42; the point where the directions  $AB$  and  $CD$  of the string in the two experiments intersect each other is the centre of gravity required. For the resultant of the earth's attraction being a vertical force applied at the centre of gravity, the body can only be in equilibrium when this point lies vertically

under the point of suspension, that is in the prolongation of the suspended string. But the centre of gravity, being in AB as well as in CD, must coincide with the point of intersection of these two lines.



Fig. 41.

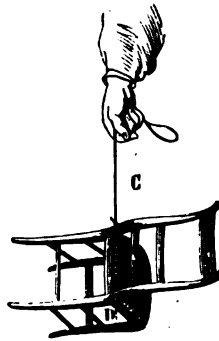

Fig. 42.

**70. Equilibrium of heavy bodies.**—Since the action of gravity upon a body reduces itself to a single vertical force applied at the centre of gravity and directed towards the earth's centre, equilibrium will be established only when this resultant is balanced by the resultant of other forces and resistances acting on the body at the fixed point through which it passes.

When only one point of the body is fixed, it will be in equilibrium if the vertical line through its centre of gravity passes through the fixed point. If more than one point is supported, the body will be in equilibrium if a vertical line through the centre of gravity passes through a point within the polygon formed by joining the points of support.

The Leaning Tower of Pisa continues to stand because the vertical line drawn through its centre of gravity passes within its base.

It is easier to stand on our feet than on stilts, because in the latter case the smallest motion is sufficient to cause the vertical line through the centre of gravity of our bodies to pass outside the supporting base, which is here reduced to a mere line joining the feet of the stilts. Again, it is impossible to stand on one leg if we keep one side of the foot and head close to a vertical wall, because the latter prevents us from throwing the body's centre of gravity vertically above the supporting base.

**71. Different states of equilibrium.**—Although a body supported by a fixed point is in equilibrium whenever its centre of gravity is in the vertical line through that point, the fact that the centre of gravity tends incessantly to occupy the lowest possible position leads us to distinguish between three states of equilibrium—*stable, unstable, neutral*.

A body is said to be in *stable equilibrium* if it tends to return to its first position after the equilibrium has been slightly disturbed. Every body is in this state when its position is such that the slightest alteration of the same elevates its centre of gravity; for the centre of gravity will descend again

when permitted, and after a few oscillations the body will return to its original position.

The pendulum of a clock continually oscillates about its position of stable equilibrium, and an egg on a level table is in this state when its long axis is horizontal. We have another illustration in the toy represented in the adjoining fig. 43. A small figure cut in ivory is made to stand on one foot at the top of a pedestal by being loaded with two leaden balls, *a, b*, placed sufficiently low to throw the centre of gravity, *g*, of the whole compound body below the foot of the figure. After being disturbed the little figure oscillates like a pendulum, having its point of suspension at the toe, and its centre of gravity at a lower point, *g*.

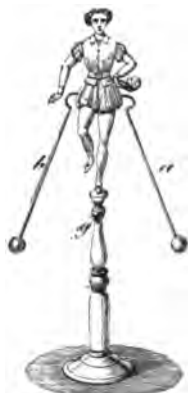

Fig. 43.

A body is said to be in *unstable equilibrium*, when after the slightest disturbance it tends to depart still more from its original position. A body is in this state when its centre of gravity is vertically above the point of support, or higher than it would be in any adjacent position of the body. An egg standing on its end, or a stick balanced upright on the finger, is in this state.

Lastly, if in any adjacent position a body still remains in equilibrium, its state of equilibrium is said to be *neutral*. In this case an alteration in the position of the body neither raises nor lowers its centre of gravity. A perfect sphere resting on a horizontal plane is in this state.

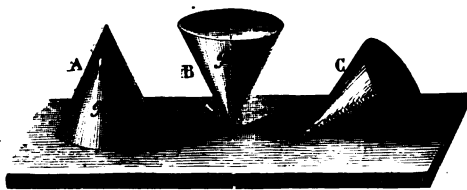

Fig. 44.

Fig. 44 represents three cones, A, B, C, placed respectively in stable, unstable, and neutral equilibrium upon a horizontal plane. The letter *g* in each shows the position of the centre of gravity.

72. **The balance.**—The balance is an instrument for determining the relative weights or masses of bodies. There are many varieties.

The ordinary balance (fig. 45) consists of a lever of the first kind, called the *beam*, AB, with its fulcrum in the middle; at the extremities of the beam are suspended two scale pans, C and D, one intended to receive the object to be weighed, and the other the counterpoise. The fulcrum consists of a steel prism, *n*, commonly called a *knife edge*, which passes through the beam, and rests with its sharp edge, or *axis of suspension*, upon two supports; these are formed of agate or polished steel, in order to diminish the friction. A needle or pointer is fixed to the beam, and oscillates with it in front of a graduated arc,

$a$  ; when the beam is perfectly horizontal the needle points to the zero of the graduated arc.

Since by (40) two equal forces in a lever of the first kind cannot be in equilibrium unless their leverages are equal, the length of the arms  $\approx A$  and

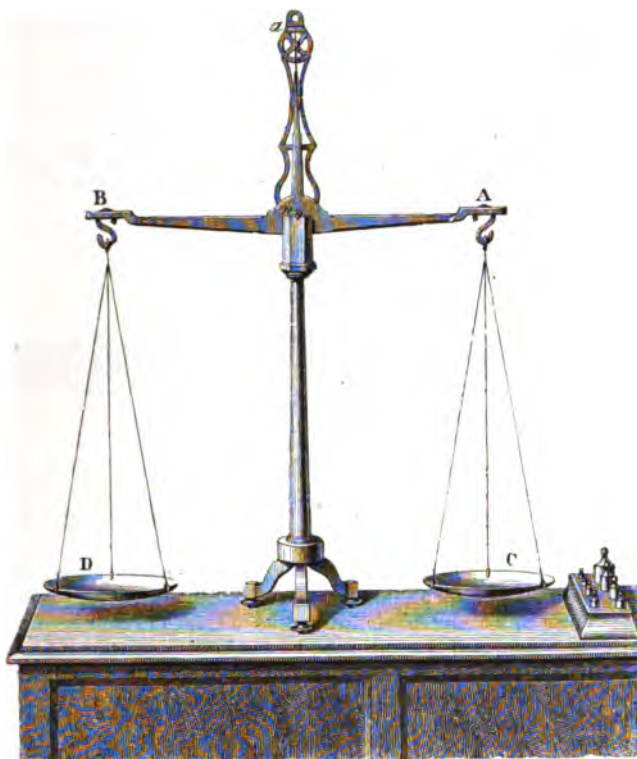

Fig. 45.

$\approx B$  ought to remain equal during the process of weighing. To secure this the scales are suspended from hooks, whose curved parts have sharp edges, and rest on similar edges at the ends of the beam. In this manner the scales are supported on mere points, which remain unmoved during the oscillations of the beam. This mode of suspension is represented in fig. 45.

**73. Conditions to be satisfied by a balance.**—A good balance ought to satisfy the following conditions :

i. *The two arms of the beam ought to be precisely equal*, otherwise, according to the principle of the lever, unequal weights will be required to produce equilibrium. To test whether the arms of the beam are equal, weights are placed in the two scales until the beam becomes horizontal ; the contents of the scales being then interchanged, the beam will remain



horizontal if its arms are equal, but if not, it will descend on the side of the longer arm.

ii. *The balance ought to be in equilibrium when the scales are empty, for otherwise unequal weights must be placed in the scales in order to produce equilibrium. It must be borne in mind, however, that the arms are not necessarily equal, even if the beam remains horizontal when the scales are empty; for this result might also be produced by giving to the longer arm the lighter scale.*

iii. *The beam being horizontal, its centre of gravity ought to be in the same vertical line with the edge of the fulcrum, and a little below the latter, for otherwise the beam would not be in stable equilibrium (71).*

The effect of changing the position of the centre of gravity may be shown by means of a beam (fig. 46), whose fulcrum, being the nut of a screw, *a*, can be raised or lowered by turning the screw-head, *b*.

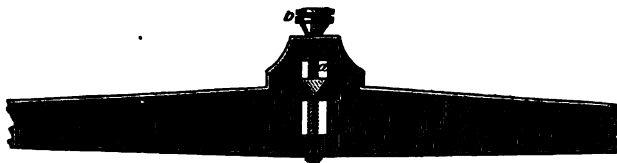

Fig. 46.

When the fulcrum is at the top of the groove *c*, in which it slides, the centre of gravity of the beam is below its edge, and the latter oscillates freely about a position of stable equilibrium. By gradually lowering the fulcrum its edge may be made to pass through the centre of gravity of the beam when the latter is in neutral equilibrium: that is to say, it no longer oscillates, but remains in equilibrium in all positions. When the fulcrum is lowered still more, the centre of gravity passes above its edge, the beam is in a state of unstable equilibrium, and is overturned by the least displacement.

74. **Delicacy of the balance.**—A balance is said to be *delicate* when a very small difference between the weights in the scales causes a perceptible deflection of the pointer.

Let *A* and *B* (figs. 47 and 48) be the points from which the scale pans are

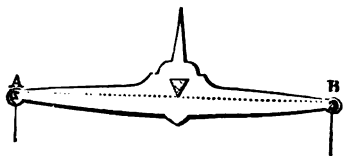

Fig. 47.

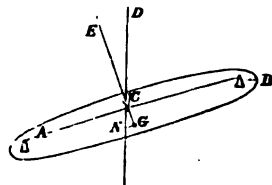

Fig. 48.

suspended, and *C* the axis of suspension of the beam. *A*, *B*, and *C* are supposed to be in the same straight line, according to the usual arrangement. Suppose weights *P* and *Q* to be in the pans, suspended from *A* and *B* re-

spectively, and let  $G$  be the centre of gravity of the beam; then the beam will come to rest in the position shown in the figure where the line  $DCN$  is vertical, and  $ECG$  is the direction of the pointer. According to the above statement, the greater the angle  $ECD$  for a given difference between  $P$  and  $Q$ , the greater is the delicacy of the balance. Draw  $GN$  at right angles to  $CG$ .

Let  $W$  be the weight of the beam, then from the properties of the lever it follows that measuring moments with respect to  $C$ , the moment of  $P$  equals the sum of the moments of  $Q$  and  $W$ , a condition which at once leads to the relation

$$(P - Q) AC = W \times GN$$

Now it is plain that for a given value of  $CG$  the angle  $GCN$  (that is  $ECD$ , which measures the delicacy) is greater as  $GN$  is greater: and from the formula it is clear that for a given value of  $P - Q$  we shall have  $GN$  greater as  $AC$  is greater, and as  $W$  is less. Again, for a given value of  $GN$  the angle  $GCN$  is greater as  $CG$  is less. Hence the means of rendering a balance delicate are:—

- i. To make the arms of the balance long.
- ii. To make the weight of the beam as small as is consistent with its rigidity.
- iii. To bring the centre of gravity of the beam a very little below the point of support.

Moreover, since friction will always oppose the action of the force that tends to preponderate, the balance will be rendered more delicate by diminishing friction: to secure this advantage the edges from which the beam and

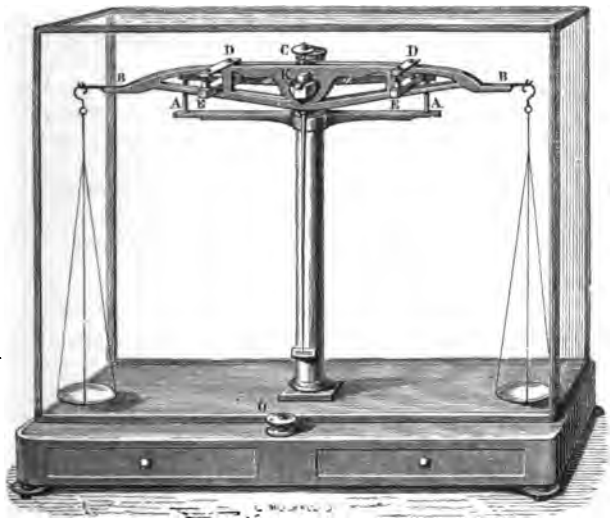

Fig. 49.

scales are suspended are made as sharp as possible, and the supports on which they rest are very hard. And, further, the pointer is made long, since

its elongation renders a given deflection more perceptible by increasing the arc which its end describes.

**75. Physical and chemical balances.**—Fig. 49 represents one of the accurate balances ordinarily used for chemical analysis. Its sensitiveness is such that when charged with a kilogramme (1,000 grms.) in each scale, an excess of a milligramme ( $\frac{1}{1000}$ th of a gm.) in either scale produces a very perceptible deflection of the index.

In order to protect the balance from air currents, dust, and moisture, it is always, even when weighing, surrounded by a glass case, whose front slides up and down, to enable the operator to introduce the objects to be weighed.

In order to preserve the edge of the fulcrum as much as possible, the whole beam, BB, with its fulcrum K, can be raised from the support on which the latter rests by simply turning the button O outside the case.

The horizontality of the beam is determined by means of a long index, which points downwards to a graduated arc near the foot of the supporting pillar.

Lastly, the button C serves to alter the sensitiveness of the balance; by turning it, the centre of gravity of the beam can be made to approach or recede from the fulcrum (73).

**76. Method of double weighing.**—Notwithstanding the inaccuracy of a balance, the true weight of a body may always be determined by its means. To do so, the body to be weighed is placed in one scale, and shot or sand poured into the other until equilibrium is produced; the body is then replaced by known weights until equilibrium is re-established. The sum of these weights will necessarily be equal to the weight of the body, for, acting under precisely the same circumstances, both have produced precisely the same effect.

The exact weight of a body may also be determined by placing it successively in the two pans of a balance, and then deducing its true weight.

For, having placed in one pan the body to be weighed, whose true weight is  $x$ , and in the other the weight  $p$ , required to balance it, let  $a$  and  $b$  be the arms of levers corresponding to  $x$  and  $p$ . Then from the principle of the lever (40) we have  $ax = pb$ . Similarly if  $p_1$  is the weight when the body is placed in the other pan, then  $bx = ap_1$ . Hence  $abx^2 = abpp_1$ , from which  $x = \sqrt{pp_1}$ .

## CHAPTER II.

### LAWS OF FALLING BODIES. INTENSITY OF TERRESTRIAL GRAVITY. THE PENDULUM.

**77. Laws of falling bodies.**—Since a body falls to the ground in consequence of the earth's attraction on *each* of its molecules, it follows that, everything else being the same, all bodies, great and small, light and heavy, ought to fall with equal rapidity, and a lump of sand without cohesion should, during its fall, retain its original form as perfectly as if it were compact stone. The fact that a stone falls more rapidly than a feather is

due solely to the unequal resistances opposed by the air to the descent of these bodies ; *in a vacuum all bodies fall with equal rapidity.* To demonstrate this by experiment a glass tube about two yards long (fig. 50) may be taken, having one of its ends completely closed, and a brass cock fixed to the other. After having introduced bodies of different weights and densities (pieces of lead, paper, feather, etc.) into the tube, the air is withdrawn from it by an air-pump, and the cock closed. If the tube be now suddenly reversed, all the bodies will fall equally quickly. On introducing a little air and again inverting the tube, the lighter bodies become slightly retarded, and this retardation increases with the quantity of air introduced.

The resistance opposed by the air to falling bodies is especially remarkable in the case of liquids. The Staubbach in Switzerland is a good illustration ; an immense mass of water is seen falling over a high precipice, but before reaching the bottom it is shattered by the air into the finest mist. In a vacuum, however, liquids fall like solids without separation of their molecules. The *water-hammer* illustrates this : the instrument consists of a thick glass tube about a foot long, half filled with water, the air having been expelled by ebullition previous to closing one extremity with the blow-pipe. When such a tube is suddenly inverted, the water falls in one undivided mass against the other extremity of the tube, and produces a sharp dry sound, resembling that which accompanies the shock of two solid bodies.

From Newton's law (67) it follows that when a body falls to the earth the force of attraction which causes it to do so increases as the body approaches the earth. Unless the height from which the body falls, however, be very great, this increase will be altogether inappreciable, and the force in question may be considered as constant and continuous. If the resistance of the air were removed, therefore, the motion of all bodies falling to the earth would be uniformly accelerated, and would obey the laws already explained (49).

78. **Atwood's machine.**—Several instruments have been invented for illustrating and experimentally verifying the laws of falling bodies. Galileo, who discovered these laws in the early part of the seventeenth century, illustrated them by means of bodies falling down inclined planes. The great object of all such instruments is to diminish the rapidity of the fall of bodies without altering the character of their motion, for by this means their motion may not only be better observed, but it will be less modified by the resistance of the air (48).

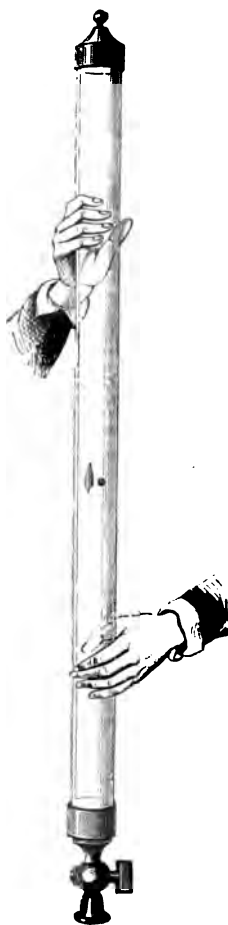

Fig. 50.

The most convenient instrument of this kind is that invented by Atwood at the end of the last century, and represented in fig. 51. It consists of

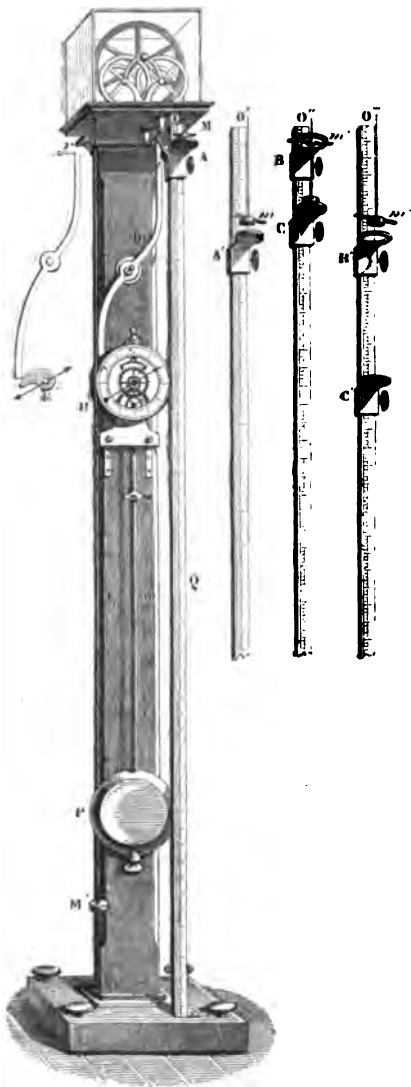

Fig. 51.

by screws at any part of the scale. The plates arrest the descending weight M, the rings only arrest the bar or overweight  $m$ , which was the cause of

a stout pillar of wood, about  $2\frac{1}{2}$  yards high, at the top of which is a brass pulley, whose axle rests and turns upon four other wheels, called *friction wheels*, inasmuch as they serve to diminish friction. Two equal weights, M and M', are attached to the extremities of a fine silk thread, which passes round the pulley; a timepiece, H, fixed to the pillar, is regulated by a seconds pendulum, P, in the usual way—that is to say, the oscillations of the pendulum are communicated to a ratchet, whose two teeth, as seen in the figure, fit into those of the ratchet wheel. The axle of this wheel gives motion to the seconds hand of the dial, and also to an eccentric behind the dial, as shown at E by a separate figure. This eccentric plays against the extremity of a lever D, which it pushes until the latter no longer supports the small plate, *i*, and thus the weight M, which at first rested on this plate, is suddenly exposed to the free action of gravity. The eccentric is so constructed that the little plate *i* falls precisely when the hand of the dial points to zero.

The weights M and M', being equal, hold each other in equilibrium; the weight M, however, is made to descend slowly by putting a small bar or overweight  $m$  upon it; and to measure the spaces which it describes, the rod or scale, Q, is divided into feet and inches, commencing from the plate *i*. To complete the instrument, there are a number of plates, A, A', C, C', and a number of rings, B, B', which may be fixed

motion, so that after passing through them, the weight  $M$ , in consequence of its inertia, will move on uniformly with the velocity it had acquired on reaching the ring. The several parts of the apparatus being described, a few words will suffice to explain the method of experimenting.

Let the hand of the dial be placed behind the zero point, the lever  $D$  adjusted to support the plate  $i$ , on which the weight  $M$  with its overweight  $m$  rests, and the pendulum put in motion. As soon as the hand of the dial points to zero the plate  $i$  will fall, the weights  $M$  and  $m$  will descend, and by a little attention and a few trials it will be easy to place a plate  $A$  so that  $M$  may reach it exactly as the dial indicates the expiration of one second. To make a second experiment, let the weights  $M$  and  $m$ , the plate  $i$ , and the lever  $D$ , be placed as at first; remove the plate  $A$ , and in its place put a ring,  $B$ , so as to arrest the overweight  $m$  just when the weight  $M$  would have reached  $A$ ; on putting the pendulum in motion again it will be easy, after a few trials, to put a plate,  $C$ , so that the weight  $M$  may fall upon it precisely when the hand of the dial points to two seconds. Since the overweight  $m$  in this experiment was arrested by the ring  $B$  at the expiration of one second, the space  $BC$  was described by  $M$  in one second purely in virtue of its own inertia, and consequently, by (25)  $BC$  will indicate the velocity of the falling mass at the expiration of one second.

Proceeding in the same manner as before, let a third experiment be made in order to ascertain the point  $B'$  at which the weight  $M$  and  $m$  arrive after the lapse of two seconds, and putting a ring at  $B'$ , ascertain by a fourth experiment the point  $C'$  at which  $M$  arrives alone, three seconds after the descent commenced;  $B'C'$  will then express the velocity acquired after a descent of two seconds. In a similar manner, by a fifth and sixth experiment, we may determine the space  $OB''$  described in three seconds, and the velocity  $B''C''$  acquired during those three seconds, and so on; we shall find that  $B'C'$  is twice, and  $B''C''$  three times as great as  $BC$ —in other words, that the velocities  $BC$ ,  $B'C'$ ,  $B''C''$ , increase in the same proportion as the times (1, 2, 3, . . . seconds) employed in their acquirement. By the definition (49), therefore, the motion is uniformly accelerated. The same experiments will also serve to verify and illustrate the four laws of uniformly accelerated motion as enunciated in (49). For example, the spaces  $OB$ ,  $OB'$ ,  $OB''$ , . . . . . described from a state of rest in 1, 2, 3, . . . . . seconds, will be found to be proportional to the numbers 1, 4, 9, . . . that is to say, to the squares of those numbers of seconds, as stated in the third law.

Lastly, if the overweight  $m$  be changed, the acceleration or velocity  $BC$  acquired per second will also be changed, and we may easily verify the assertion in (29), that force is proportional to the product of the mass moved into the acceleration produced in a given time. For instance, assuming the pulley to be so light that its inertia can be neglected, if  $m$  weighed half an ounce, and  $M$  and  $M'$  each  $15\frac{3}{4}$  ounces, the acceleration  $BC$  would be found to be six inches; whilst if  $m$  weighed 1 ounce, and  $M$  and  $M'$  each  $63\frac{3}{4}$  ounces, the acceleration  $BC$  would be found to be three inches.

Now in these cases the forces producing motion, that is the overweights, are in the ratio of 1 : 2; while the products of the masses and the accelerations are in the ratio of  $(\frac{1}{2} + 15\frac{3}{4} + 15\frac{3}{4}) \times 6$  to  $(1 + 63\frac{3}{4} + 63\frac{3}{4}) \times 3$ , that is, they are also in the ratio of 1 : 2. Now the same result is obtained in whatever way the

magnitudes of  $m$ ,  $M$ , and  $M'$  are varied, and consequently in all cases the ratio of the forces producing motion equals the ratio of the momenta generated.

79. **Morin's apparatus.**—The principle of this apparatus, the original idea of which is due to General Poncelet, is to make the body in falling trace its own path. Figure 52 gives a view of the whole apparatus, and figure

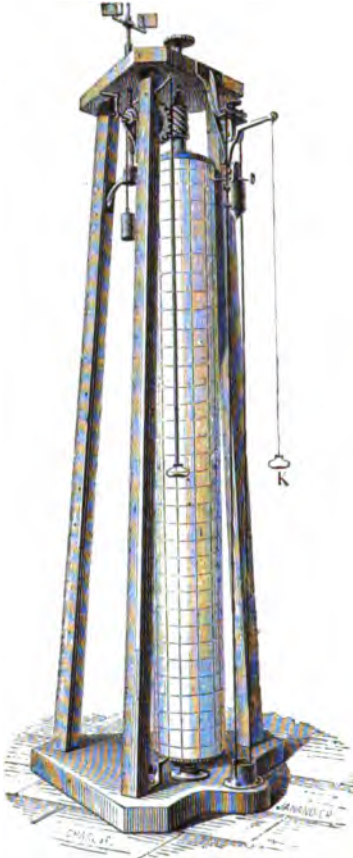

Fig. 52.

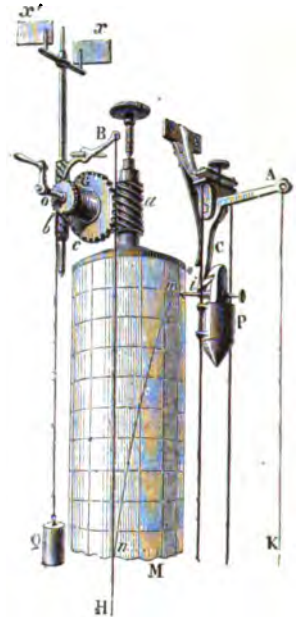

Fig. 53.

53 gives the details. The apparatus consists of a wooden frame-work, about 7 feet high, which holds in a vertical position a very light wooden cylinder,  $M$ , which can turn freely about its axis. This cylinder is coated with paper divided into squares by equidistant horizontal and vertical lines. The latter measure the path traversed by the body falling along the cylinder, while the horizontal lines are intended to divide the duration of the fall into equal parts.

The falling body is a mass of iron, P, provided with a pencil which is pressed against the paper by a small spring. The iron is guided in its fall by two light iron wires which pass through guide-holes on the two sides. The top of this mass is provided with a tipper which catches against the end of a bent lever, AC. This being pulled by the string K attached at A, the weight falls. If the cylinder M were fixed, the pencil would trace a straight line on it; but if the cylinder moves uniformly, the pencil traces the line *mn*, which serves to deduce the law of the fall.

The cylinder is rotated by means of a weight, Q, suspended to a cord which passes round the axle G. At the end of this is a toothed wheel, *c*, which turns two endless screws, *a* and *b*, one of which turns the cylinder, and the other two vanes, *x* and *x'* (fig. 53). At the other end is a ratchet wheel, in which fits the end of a lever, B; by pulling at a cord fixed to the other end of B, the wheel is liberated, the weight Q descends, and the whole system begins to turn. The motion is at first accelerated, but as the air offers a resistance to the vanes (48), which increases as the rotation becomes more rapid, the resistance finally equals the acceleration which gravity tends to impart. From this time the motion becomes uniform. This is the case when the weight Q has traversed about three-quarters its course; at this moment the weight P is detached by pulling the cord K, and the pencil then traces the curve *mn*.

If, by means of this curve, we examine the double motion of the pencil on the small squares which divide the paper, we see that, for displacements 1, 2, 3, . . . in a horizontal direction, the displacements are 1, 4, 9 . . . in a vertical direction. This shows that the paths traversed in the direction of the fall are directly as the squares of the lines in the direction of the rotation, which verifies the second law of falling bodies.

From the relation which exists between the two dimensions of the curve *mn*, it is concluded that this curve is a *parabola*.

**80. The length of the compound pendulum.**—The formula deduced in article 55 and the conclusions which follow therefrom refer to the case of the simple or mathematical pendulum, that is to a single heavy point suspended by a thread without weight. Such a pendulum has only an imaginary existence, and any pendulum which does not realise these conditions is called a *compound* or *physical* pendulum. The laws for the time of vibration of a compound pendulum are the same as those which regulate the motion of the simple pendulum, though it will be necessary to define accurately what is meant by the *length* of such a pendulum. A compound pendulum being formed of a heavy rod terminated by a greater or less mass, it follows that the several material points of the whole system will strive to perform their oscillations in different times, their distances from the axis of suspension being different, and the more distant points requiring a longer time to complete an oscillation. From this, and from the fact that being points of the same body they must all oscillate together, it follows that the motion of the points near the axis of suspension will be retarded, whilst that of the more distant points will be accelerated, and between the two extremities there will necessarily be a series of points whose motion will be neither accelerated nor retarded, but which will oscillate precisely as if they were perfectly free and unconnected with the other points of the system.



These points, being equidistant from the axis of suspension, constitute a parallel axis known as the *axis of oscillation*; and it is to the distance between these two axes that the term *length of the compound pendulum* is applied: we may say, therefore, that *the length of a compound pendulum is that of the simple pendulum which would describe its oscillations in the same time.*

Huyghens, the celebrated Dutch physicist, discovered that the axes of suspension and oscillation are mutually convertible—that is to say, the time of oscillation will remain unaltered when the pendulum is suspended from its axis of oscillation. This enables us to determine experimentally the length of the compound pendulum. For this purpose the *reversible pendulum* devised by Bohnenberger and Kater may be used. One form of this (fig. 54) is a rod with the knife-edges turned towards each other. W and V are lense-shaped masses the relative positions of which may be varied. By a series of trials a position can be found such that the number of oscillations of the pendulum in a given time is the same whether it oscillates about the axis *a* or the axis *b*. This being so, the distance *ab* represents the length *l* of a simple pendulum which has the same time of oscillation. From the value of *l*, thus obtained, it is easy to determine the length of the seconds pendulum.

The length of the *seconds pendulum*—that is to say, of the pendulum which makes one oscillation in a second—varies, of course, with the intensity of gravity. The following table gives its value at the sea level at various places. The accelerative effect of gravity at these places, according to formula (51), is obtained in feet and metres by multiplying the length of the seconds pendulum, reduced to feet and metres, by the square of 3·14159.



Fig. 54.

		Length of Pendulum in inches.	Acceleration of Gravity in	
			feet.	metres.
Hammerfest	70°40' N.	39·1948	32·2364	9·8258
Konigsberg . . .	54°42	39·1507	32·2002	9·8142
Greenwich . . .	51°29	39·1398	32·1912	9·8115
Paris . . . . .	48°50	39·1285	32·1819	9·8039
New York . . . .	40°43	39·1012	32·1594	9·8019
St. Thomas . . .	0°25	39·0207	32·0957	9·7826
Cape of Good Hope	33°55 S.	39·0780	32·1401	9·7962

Consequently,  $\frac{1}{2}g$  or the space described in the first second of its motion by a body falling *in vacuo* from a state of rest (49) is

16·0478 feet or 4·891 metres at St. Thomas,  
 16·0956 " " 4·905 " at London, and  
 16·1182 " " 4·913 " at Hammerfest.

In all calculations which are used for the sake of illustration we may take 32 feet or 9·8 metres as the accelerative effect due to gravity.

From observations of this kind, after applying the necessary corrections,

and taking into account the effect of rotation (83), the form of the earth can be deduced. ✓

81. **Verification of the laws of the pendulum.**—In order to verify the laws of the simple pendulum (55) we are compelled to employ a compound one, whose construction differs as little as possible from that of the former. For this purpose a small sphere of a very dense substance, such as lead or platinum, is suspended from a fixed point by means of a very fine metal wire. A pendulum thus formed oscillates almost like a simple pendulum, whose length is equal to the distance of the centre of the sphere from the point of suspension.

In order to verify the isochronism of small oscillations, it is merely necessary to count the number of oscillations made in equal times, as the amplitudes of these oscillations diminish from 3 degrees to a fraction of a degree; this number is found to be constant.

That the time of vibration is proportional to the square root of the length is verified by causing pendulums, whose lengths are as the numbers 1, 4, 9, . . . . to oscillate simultaneously. The corresponding numbers of oscillations in a given time are then found to be proportional to the fractions  $1, \frac{1}{2}, \frac{1}{3}$ , etc. . . . . which shows that the times of oscillation increase as the numbers 1, 2, 3, . . . . etc.

By taking several pendulums of exactly equal length, B, C, D (fig. 55), but with spheres of different substances, lead, copper, ivory, it is found that, neglecting the resistance of the air, these pendulums oscillate in equal times, thereby showing that the accelerative effect of gravity on all bodies is the same at the same place.

By means of an arrangement resembling the above, Newton verified the fact that the *masses* of bodies are determined by the balance; which, it will be remarked, lies at the foundation of the measure of force (29). For it will be seen on comparing (54) and (55) with (50) that the law of the time of a small oscillation is obtained on the supposition that the force of gravity on all bodies is represented by  $Mg$ , in which  $M$  is determined by the balance. In order to verify this, he had made two round equal wooden boxes; he filled one with wood, and as nearly as possible in the centre of oscillation of the other he placed an equal weight of gold. He then suspended the boxes by threads eleven feet long, so that they formed pendulums exactly equal so far as weight, figure, and resistance of the air were concerned. Their oscillations were performed in exactly the same time. The same results were obtained when other substances were used, such as silver, lead, glass, sand, salt, wood, water, corn. Now all these bodies had equal weights, and if the



Fig. 55.

inference that therefore they had equal masses had been erroneous by so much as the one-thousandth part of the whole, the experiment would have detected it.

82. **Application of the pendulum to clocks.**—The regulation of the

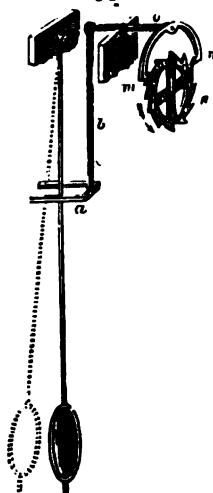

Fig. 56.

motion of clocks is effected by means of pendulums, that of watches by balance-springs. Pendulums were first applied to this purpose by Huyghens in 1658, and in the same year Hooke applied a spiral spring to the balance of a watch. The manner of employing the pendulum is shown in fig. 56. The pendulum rod passing between the prongs of a fork *a* communicates its motion to a rod *b*, which oscillates on a horizontal axis *o*. To this axis is fixed a piece *mn* called an *escapement* or *crutch*, terminated by two projections or *pallets*, which work alternately with the teeth of the *escapement wheel* R. This wheel being acted on by the weight tends to move continuously, let us say, in the direction indicated by the arrow-head. Now if the pendulum is at rest, the wheel is held at rest by the pallet *m*, and with it the whole of the clockwork and the weight. If, however, the pendulum moves and takes the position shown by the dotted line, *m* is raised, the wheel *escapes* from the confinement in which it was held by the pallet, the weight descends,

and causes the wheel to turn until its motion is arrested by the other pallet *n*; which in consequence of the motion of the pendulum will be brought into contact with another tooth of the escapement wheel. In this manner the descent of the weight is alternately permitted and arrested—or, in a word, *regulated*—by the pendulum. By means of a proper train of wheelwork the motion of the escapement is communicated to the hands of the clock; and consequently their motion, also, is regulated by the pendulum.

The pendulum has also been used for measuring great velocities. A large block of wood weighing from 3 to 5 tons is coated with iron; against this arrangement, which is known as a *ballistic-pendulum*, a shot is fired, and the deflection thereby produced is observed. From the laws of the impact of inelastic bodies, and from those of the pendulum, the velocity of the ball may be calculated from the amount of this deflection.

83. **Causes which modify the intensity of terrestrial gravitation.**—

The intensity of the force of gravity, that is the value of *g*, is not the same in all parts of the earth. It is modified by several causes, of which the form of the earth and its rotation are the most important.

i. The attraction which the earth exerts upon a body at its surface is the sum of the partial attractions which each part of the earth exerts upon that body, and the resultant of all these attractions may be considered to act from a single point, the centre. Hence, if the earth were a perfect sphere, a given body would be equally attracted at any part of the earth's surface. The attraction would, however, vary with the height above the surface. For small alterations of level the differences would be inappreciable; but for greater heights and in accurate measurements observations of the value of *g* must

be reduced to the sea level. The attraction of gravitation being inversely as the square of the distance from the centre (67) we shall have

$g : g_1 = \frac{1}{R^2} : \frac{1}{(R+h)^2}$  where  $g$  is the value of the acceleration of gravity at the sea level,  $g_1$  its value at any height  $h$ , and  $R$  is the radius of the earth. From this, seeing that  $h$  is very small compared with  $R$ , we get by simple algebraical transformation  $g_1 = \frac{g}{1 + \frac{2h}{R}}$

But even at the sea level the force of gravity varies in different parts in consequence of the form of the earth. The earth is not a true sphere but an ellipsoid, the major axis of which is 12,754,796 metres, and the minor 12,712,160 metres. The distance, therefore, at the centre being greater at the equator than at the Poles, and as the attraction on a body is inversely as the square of these distances, calculation shows that the attraction due to this cause is  $\frac{1}{374}$  greater at the Poles than at the equator. This is what would be true if, other things being the same, the earth were at rest.

ii. In consequence of the earth's rotation, the force of gravity is further modified. If we imagine a body relatively at rest on the equator, it really shares the earth's rotation, and describes, in the course of one day, a circle whose centre and radius are the centre and radius of the earth. Now since a body in motion tends by reason of its inertia to move in a straight line, it follows that to make it move in a circle, a force must be employed at each instant to deflect it from the tangent (53). Consequently, a certain portion of the earth's attraction must be employed in keeping the above body on the surface of the earth, and only the remainder is sensible as *weight* or *accelerating force*. It appears from calculation that on the equator the  $\frac{1}{289}$ th part of the earth's attraction on any body is thus employed, so that the magnitude of  $g$  at the equator is less by the  $\frac{1}{289}$  part of what it would be were the earth at rest.

iii. As the body goes nearer the Poles the force of gravity is less and less diminished by the effect of centrifugal force. For in any given latitude it will describe a circle coinciding with the parallel of latitude in which it is placed; but as the radii of these circles diminish, so does the centrifugal force until the Pole, where the radius is null. Further, on the equator the centrifugal force is directly opposed to gravitation; in any other latitude only a component of the whole force is thus employed. This is seen in figure 57, in which  $PP'$  represents the axis of rotation of the earth and  $EE'$  the equator. At any given point  $E$  on the equator the centrifugal force is directed along  $CE$ , and acts wholly in diminishing the intensity of gravitation; but on any other point,  $a$ , nearer the Pole, the centrifugal force acting on a right line  $ab$  at right angles to the axis  $PP'$ , while gravity acts along  $aC$ , gravity is no longer directly diminished by centrifugal force, but only by its component  $ad$ , which is less the nearer  $a$  is to the pole.

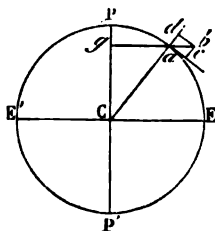

Fig. 57.

The combined effect of these two causes, the flattening of the earth at the Poles, and the centrifugal force, is to make the attraction of gravitation at the equator less by about the  $\frac{1}{108}$  part of its value at the Poles.

## CHAPTER III.

## MOLECULAR FORCES.

84. **Nature of molecular forces.**—The various phenomena which bodies present show that their molecules are under the influence of two contrary forces, one of which tends to bring them together, and the other to separate them from each other. The first force, which is called *molecular attraction*, varies in one and the same body with the distance only. The second force, which is due to the action of heat, varies with the intensity of this agent, and with the distance. It is the mutual relation between these forces, the preponderance of the one or the other, which determines the molecular state of a body (4)—whether it be solid, liquid, or gaseous.

Molecular attraction is only exerted at infinitely small distances. Its effect is inappreciable when the distance between the molecules is appreciable.

According to the manner in which it is regarded, molecular attraction is designated by the terms *cohesion*, *affinity*, or *adhesion*.

85. **Cohesion.**—*Cohesion* is the force which unites adjacent molecules of the same nature; for example, two molecules of water, or two molecules of iron. Cohesion is strongly exerted in solids, less strongly in liquids, and scarcely at all in gases. Its intensity decreases as the temperature increases, because then the repulsive force due to heat increases. Hence it is that when solid bodies are heated they first liquefy, and are ultimately converted into the gaseous state, provided that heat produces in them no chemical change.

Cohesion varies not only with the nature of bodies, but also with the arrangement of their molecules; for example, the difference between tempered and untempered steel is due to a difference in the molecular arrangement produced by tempering. It is to the modifications which this force undergoes that many of the properties of bodies are due, such as tenacity, hardness, and ductility.

In large masses of liquids, the force of gravity overcomes that of cohesion. Hence liquids acted upon by the former force have no special shape; they take that of the vessel in which they are contained. But in smaller masses cohesion gets the upper hand, and liquids present then the spheroidal form. This is seen in the drops of dew on the leaves of plants; it is also seen when a liquid is placed on a solid which it does not moisten; as, for example, mercury upon wood. The experiment may also be made with water, by sprinkling upon the surface of the wood some light powder, such as lycopodium or lampblack, and then dropping some water on it. The following pretty experiment is an illustration of the force of cohesion causing a liquid to assume the spheroidal form. A saturated solution of sulphate of zinc is placed in a narrow-necked bottle, and a few drops of bisulphide of carbon, coloured with iodine, made to float on the surface. If pure water be now carefully added, so as to rest on the surface of the sulphate of zinc solution, the bisulphide collects in the form of a flattened spheroid, which presents the appearance of blown coloured glass, and is larger than the neck of the bottle, provided a sufficient quantity has been taken.

The force of cohesion of liquids may be measured as follows. A plane, perfectly smooth, disc is suspended horizontally at one end of a delicate balance, and is accurately equipoised. A somewhat wide vessel of liquid is gradually approached from below until it just touches the disc. Weights are then carefully added to the scale pan until the disc is detached from the liquid. It has thus been found that the weights required to detach the disc vary with the nature of the liquid; with a disc of 118 mm. in diameter the numbers for water, alcohol, and turpentine were 59·4, 31 and 34 grammes respectively.

The results were the same whether the disc was of glass, of copper, or of other metals, and thus only depend on the nature of the liquid. It is a measure of the cohesion of the liquid, for a layer remains adhering to the disc, hence the weight on the other side does not separate the disc from the liquid, but separates the particles of liquid from each other.

86. **Affinity.**—*Chemical affinity* is the force which is exerted between molecules not of the same kind. Thus, in water, which is composed of oxygen and hydrogen, it is affinity which unites these elements, but it is cohesion which binds together two molecules of water. In compound bodies cohesion and affinity operate simultaneously, while in simple bodies or elements cohesion has alone to be considered.

To affinity are due all the phenomena of combustion, and of chemical combination and decomposition.

The causes which tend to weaken cohesion are most favourable to affinity; for instance, the action of affinity between substances is facilitated by their division, and still more by reducing them to a liquid or gaseous state. It is most powerfully exerted by a body in its *nascent* state, that is, the state in which the body exists at the moment it is disengaged from a compound; the body is then free, and ready to obey the feeblest affinity. An increase of temperature modifies affinity differently under different circumstances. In some cases, by diminishing cohesion, and increasing the distance between the molecules, heat promotes combination. Sulphur and oxygen, which at the ordinary temperature are without action on each other, combine to form sulphurous acid when the temperature is raised: in other cases heat tends to decompose compounds by imparting to their elements an unequal expansibility. Thus it is that many metallic oxides, as for example those of silver and mercury, are decomposed, by the action of heat, into gas and metal.

87. **Adhesion.**—The molecular attraction exerted between the *surfaces* of bodies in contact is called *adhesion*.

i. Adhesion takes place between solids. If two leaden bullets are cut with a penknife so as to form two equal and brightly polished surfaces, and the two faces are pressed and turned against each other until they are in the closest contact, they adhere so strongly as to require a force of more than 100 grammes to separate them. The same experiment may be made with two equal pieces of glass, which are polished and made perfectly plane. When they are pressed one against the other, the adhesion is so powerful that they cannot be separated without breaking. As the experiment succeeds *in vacuo*, it cannot be due to atmospheric pressure, but must be attributed to a reciprocal action between the two surfaces. The attraction also increases

as the contact is prolonged, and is greater in proportion as the contact is closer.

In the operation of gluing, the pores and crevices of the fresh surfaces being filled with liquid glue, so that there is no empty space on drying, wood and glue form one compact whole. In some cases the adhesion of the cement is so powerful that the mass breaks more readily at other places than at the cemented parts.

There is no real difference between adhesion and cohesion; thus, when two freshly cut surfaces of caoutchouc are pressed together, they adhere with considerable force, and ultimately form one compact solid mass.

ii. Adhesion also takes place between solids and liquids. If we dip a glass rod into water, on withdrawing it a drop will be found to collect at its lower extremity, and remain suspended there. As the weight of the drop tends to detach it, there must necessarily be some force superior to this weight which maintains it there: this force is the force of adhesion.

The adhesion between liquids and solids is more powerful than that between solids. Thus, if in the above experiment a thin layer of oil is interposed between the plates they adhere firmly, but when pulled asunder each plate is moistened by the oil, thus showing that in separating the plates the cohesion of the plates is overcome, but not the adhesion of the oil to the metal. Alcohol adheres more firmly to glass than water. A layer of water on a glass plate is displaced by a drop of alcohol brought on it.

iii. The force of adhesion operates, lastly, between solids and gases. If a glass or metal plate be immersed in water, bubbles will be found to appear on the surface. As air cannot penetrate into the pores of the plate, the bubbles could not arise from the air which had been expelled. It is solely due to the layer of air which covered the plate, and *moistened* it like a liquid. In many cases when gases are separated in the *nascent state* on the surface of metals—as in electrolysis—the layer of gas which covers the plate has such a density that it can produce chemical actions more powerful than those which it can bring about in the free state.

## CHAPTER IV.

### PROPERTIES PECULIAR TO SOLIDS.

88. **Various special properties.**—After having described the principal properties common to solids, liquids and gases, we shall discuss the properties peculiar to solids. They are, *elasticity of traction, elasticity of torsion, elasticity of flexure, tenacity, ductility, and hardness.*

89. **Elasticity of traction.**—Elasticity, as a general property of matter, has been already mentioned (17), but simply in reference to the elasticity developed by pressure; in solids it may also be called into play by traction, by torsion, and by flexure. The definitions there given require some extension. In ordinary life we consider those bodies as highly elastic, which, like caoutchouc, undergo considerable change on the application of only a small force. Yet the force of elasticity is greatest in many bodies, such as iron,

which do not seem to be very elastic. For by *force of elasticity* is understood the force with which the displaced particles tend to revert to their original position, and which force is equivalent to that which has brought about the change. Considered from this point of view, gases have the least force of elasticity; that of liquids is considerably greater, and is, indeed, greater than that of many solids. Thus, the force of elasticity of mercury is greater than that of caoutchouc, glass, wood, and stone. It is, however, less than that of the other metals with the exception of lead.

This seems discordant with ordinary ideas about elasticity; but it must be remembered that those bodies which, by the exertion of a small force, undergo a considerable change, generally have also the property of undergoing this change without losing the property of reverting completely to their original state. They have a wide *limit of elasticity* (17). Those bodies which require great force to effect a change are also, for the most part, those on which the exertion of a force produces a permanent alteration; when the force is no longer exerted, they do not completely revert to their original state.

In order to study the laws of the elasticity of traction, Savart used the apparatus represented in fig. 58. It consists of a wooden support from which are suspended the rods or wires taken for experiment. At the lower extremity there is a scale pan, and on the wire two points, A and B, are marked, the distance between which is measured by means of the *cathetometer*, before the weights are added.

The *cathetometer* consists of a strong brass support, K, divided into millimetres, and which can be adjusted in a vertical position by means of levelling screws and the plumb line. A small telescope, exactly at right angles to the scale, can be moved up and down, and is provided with a vernier which measures fiftieths of a millimetre. By fixing the telescope successively on the two points A and B, as represented in the figure, the distance between these points is obtained on the graduated scale. Placing then weights in the pan,

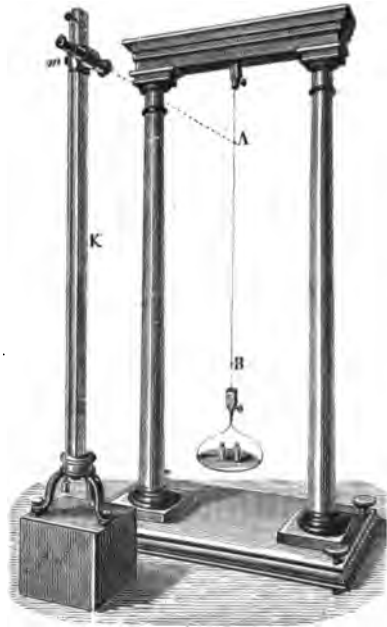

Fig. 58.

and measuring again the distance from A to B, the elongation is obtained.

By experiments of this kind it has been ascertained that for elasticity of traction or pressure—

*The alteration in length, within the limits of elasticity, is in proportion*



to the length and to the load acting on the body, and is inversely as the section.

It depends, moreover, on the *specific elasticity*, that is, on the material of the body. If this coefficient be denoted by  $E$ , and if the length, section, and load are respectively designated by  $l$ ,  $s$ , and  $P$ , then for the alteration in length,  $e$ , we have

$$e = E \frac{lP}{s}.$$

If in the above expression the sectional area be a square millimetre, and  $P$  be one kilogramme, then

$$e = El, \text{ from which } E = \frac{e}{l}.$$

which expresses by what fraction the length of a bar a square millimetre in section is altered by a load of a kilogramme. This is called the *coefficient of elasticity*; it is a very small fraction, and it is therefore desirable to use its reciprocal, that is  $\frac{1}{e}$  or  $\mu$  as the *modulus of elasticity*; or the weight in kilogrammes which applied to a bar would elongate it by its own length, assuming it to be perfectly elastic. This cannot be observed, for no body is perfectly elastic, but it may be calculated from any accurate observations by means of the above formula.

The following are the best values for some of the principal substances :—

Steel . . . . .	21,000	Silver . . . . .	7,400
Wrought Iron . . . . .	19,000	Lead . . . . .	1,800
Copper . . . . .	12,400	Wood . . . . .	1,100
Brass . . . . .	9,000	Whalebone . . . . .	700
Zinc . . . . .	8,700	Glass . . . . .	90

Thus, to double the length of a wrought-iron wire a square millimetre in section, would (if this were possible) require a weight of 19,000 kilogrammes; but a weight of 15 kilogrammes produces a permanent alteration in length of  $\frac{1}{1354}$ th, and this is the limit of elasticity. The weight which when applied to a body of the unit of section just brings about an appreciable permanent change is a measure of the limit of elasticity. Whalebone, on the contrary, has only a modulus of 700, and experiences a permanent change by a weight of 5 kilogrammes; its limit is, therefore, relatively greater than that of iron. Steel has a high modulus, along with a wide limit.

Both calculation and experiment show that when bodies are lengthened by traction their volume increases.

When weights are placed on a bar, the amount by which it is shortened, or the *coefficient of contraction*, is equal to the elongation which it would experience if the same weights were suspended to it; and is represented by the above numbers.

From numerous experiments on the elasticity of iron, copper, and brass made by Kohlrausch, it follows that the modulus of elasticity diminishes as the temperature rises.

**90. Elasticity of Torsion.**—The laws of the torsion of wires were determined by Coulomb, by means of an apparatus called the *torsion balance* (fig. 59). It consists of a metal wire, clasped at its upper extremity in a

support, A, and holding at the other extremity a metal sphere, B, to which is affixed an index, C. Immediately below this there is a graduated circle, CD. If the needle is turned from its position of equilibrium through a certain angle, which is the *angle of torsion*, the force necessary to produce this effect is the *force of torsion*. When, after this deflection, the sphere is left to itself, the reaction of torsion produces its effect, the wire untwists itself, and the sphere rotates about its vertical axis with increasing rapidity until it reaches its position of equilibrium. It does not, however, rest there; in virtue of its inertia it passes this position, and the wire undergoes a torsion in the opposite direction. The equilibrium being again destroyed, the wire again tends to untwist itself, the same alterations are again produced, and the needle does not rest at zero of the scale until after a certain number of oscillations about this point have been completed.

By means of this apparatus Coulomb found that when the amplitude of the oscillations is within certain limits, the oscillations are subject to the following laws :

I. *The oscillations are very nearly isochronous.*

II. *For the same wire, the angle of torsion is proportional to the moment of the force of torsion.*

III. *With the same force of torsion, and with wires of the same diameter, the angles of torsion are proportioned to the lengths of the wires.*

IV. *The same force of torsion being applied to wires of the same length, the angles of torsion are inversely proportional to the fourth powers of the diameters.*

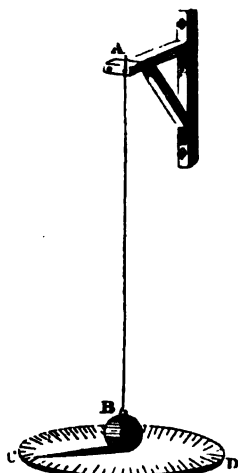

Fig. 59.

Wertheim has examined the elasticity of torsion in the case of stout rods by means of a different apparatus, and finds that it is also subject to these laws. He has further found that, all dimensions being the same, different substances undergo different degrees of torsion, and each substance has its own coefficient of torsion, which is denoted by  $\frac{1}{T}$ .

The laws of torsion may be enunciated in the formula  $w = \frac{1}{T} \frac{Fl}{r^4}$ ; in which  $w$  is the angle of torsion,  $F$  the moment of the force of torsion,  $l$  the length of the wire,  $r$  its diameter, and  $\frac{1}{T}$  the specific torsion-coefficient.

91. **Elasticity of flexure.**—A solid, when cut into a thin plate, and fixed at one of its extremities, after having been more or less bent, strives to return to its original position when left to itself. This property is the elasticity of flexure and is very distinct in steel, caoutchouc, wood, and paper.

If a rectangular bar be clamped at one end and loaded at the other, the flexure  $e$  is represented by the formula

$$e = \frac{Pl}{bh^3\mu},$$

where  $P$  is the load,  $l$  the length of the bar,  $b$  its breadth,  $h$  its vertical height, and  $\mu$  the modulus of elasticity.

The elasticity of flexure is applied in a vast variety of instances, for example, in bows, watch springs, carriage springs; in spring balances it is used to determine weights, in dynamometers to determine the force of agents in prime movers; and, as existing in wool, hair, and feathers, it is applied to domestic uses in cushions and mattresses.

Whatever be the kind of elasticity, there is, as has been already said, a limit to it—that is, there is a molecular displacement, beyond which bodies are broken, or at any rate do not regain their primitive form. This limit is affected by various causes. The elasticity of many metals is increased by *hardening*, whether by cold, by means of the draw-plate, by rolling, or by hammering. Some substances, such as steel, cast iron, and glass, become both harder and more elastic by tempering (95).

Elasticity, on the other hand, is diminished by *annealing*, which consists in raising the body to a temperature lower than that necessary for tempering, and allowing it to cool slowly. It is by this means that the elasticity of springs may be regulated at pleasure. Glass, when it is heated, undergoes a true tempering in being rapidly cooled, and hence, in order to lessen the fragility of glass objects, they are reheated in a furnace, and are carefully allowed to cool slowly, so that the particles have time to assume their most stable position.

92. **Tenacity.**—*Tenacity* is the resistance which a body opposes to the total separation of its parts. According to the manner in which the external force acts, may we have various kinds of tenacity; *tenacity* in the ordinary sense, or resistance to traction; *relative tenacity*, or resistance to fracture; *reactive tenacity*, or resistance to crushing; *sheering tenacity*, or resistance to displacement of particles in a lateral direction, and *torsional tenacity*, or resistance to twisting. Ordinary tenacity is determined in different bodies by forming them into cylindrical or prismatic wires, and ascertaining the weight necessary to break them.

*Tenacity is directly proportional to the breaking weight, and inversely proportional to the area of a transverse section of the wire.*

Tenacity diminishes with the duration of the traction. A small force continuously applied for a long time will often break a wire, which would not at once be broken by a larger weight.

Not only does tenacity vary with different substances, but it also varies with the form of the body. Thus, with the same sectional area, a cylinder has greater tenacity than a prism. The quantity of matter being the same, a hollow cylinder has greater tenacity than a solid one; and the tenacity of this hollow cylinder is greatest when the external radius is to the internal one in the ratio of 11 to 5.

The shape has also the same influence on the resistance to crushing as it has on the resistance to traction. A hollow cylinder with the same mass, and the same weight, offers a greater resistance than a solid cylinder. Thus it is that the bones of animals, the feathers of birds, the stems of corn and other plants, offer greater resistance than if they were solid, the mass remaining the same.

Tenacity, like elasticity, is different in different directions in bodies. In

wood, for example, both the tenacity and the elasticity are greater in the direction of the fibres than in a transverse direction. And this difference obtains in general in all bodies, the texture of which is not the same in all directions.

Wertheim found the following numbers representing the weight in kilogrammes for the limit of elasticity and for the tenacity of wires, 1 mm. in diameter :—

		Limit of Elasticity. Kilogrammes.	Tenacity. Kilogrammes.
Lead . . .	{ drawn . . .	0·25 . . .	2·07
	{ annealed . . .	0·20 . . .	1·80
Tin . . .	{ drawn . . .	0·45 . . .	2·45
	{ annealed . . .	0·20 . . .	1·70
Gold . . .	{ drawn . . .	13·50 . . .	27·00
	{ annealed . . .	3·00 . . .	10·08
Silver . . .	{ drawn . . .	11·25 . . .	29·00
	{ annealed . . .	2·75 . . .	16·02
Zinc . . .	{ drawn . . .	0·75 . . .	12·80
	{ annealed . . .	1·00 . . .	
Copper . . .	{ drawn . . .	12·00 . . .	40·30
	{ annealed . . .	3·00 . . .	30·54
Platinum . . .	{ drawn . . .	26·00 . . .	34·10
	{ annealed . . .	14·50 . . .	23·50
Iron . . .	{ drawn . . .	32·5 . . .	61·10
	{ annealed . . .	5·0 . . .	46·88
Steel . . .	{ drawn . . .	42·5 . . .	70·00
	{ annealed . . .	15·0 . . .	40·00
Cast Steel . . .	{ drawn . . .	55·6 . . .	80·00
	{ annealed . . .	5·0 . . .	65·75

In this table the bodies are supposed to be at the ordinary temperature. At higher temperatures the tenacity rapidly decreases. Mr. Seguin, sen., made some experiments on this point with iron and copper, and obtained the following values for the tenacity, in kilogrammes, of millimetre wire at different temperatures :—

Iron . . .	at 10°, 60 ; at 370°, 54 ; at 500°, 37 ;
Copper . . .	„ 21 ; „ 77 ; „ 0.

93. **Ductility.**—*Ductility* is the property in virtue of which a great number of bodies change their forms by the action of traction or pressure.

With certain bodies, such as clay, wax, etc., the application of a very little force is sufficient to produce a change ; with others, such as the resins and glass, the aid of heat is needed, while with the metals more powerful agents must be used, such as percussion, the draw-plate, or the rolling-mill.

*Malleability* is that modification of ductility which is exhibited by hammering. The most malleable metal is gold, which has been beaten into leaves about the  $\frac{1}{800000}$ th of an inch thick.

The most ductile metal is platinum. Wollaston obtained a wire of it 0·00003 of an inch in diameter. This he effected by covering with silver a platinum wire 0·01 of an inch in diameter, so as to obtain a cylinder 0·2 inch

in diameter only; the axis of which was of platinum. This was then drawn out in the form of wire as fine as possible; the two metals were equally extended. When this wire was afterwards treated with dilute nitric acid the silver was dissolved, and the platinum wire left intact. The wire was so fine that 1,060 yards only weighed 0.75 of a grain.

94. **Hardness.**—*Hardness* is the resistance which bodies offer to being scratched or worn by others. It is only a relative property, for a body which is hard in reference to one body may be soft in reference to others. The relative hardness of two bodies is ascertained by trying which of them will scratch the other. Diamond is the hardest of all bodies, for it scratches all, and is not scratched by any. The hardness of a body is expressed by referring it to a *scale of hardness*: that usually adopted is—

- |              |            |             |
|--------------|------------|-------------|
| 1. Talc      | 5. Apatite | 8. Topaz    |
| 2. Rock salt | 6. Felspar | 9. Corundum |
| 3. Calcspar  | 7. Quartz  | 10. Diamond |
| 4. Fluorspar |            |             |

Thus, the hardness of a body which would scratch felspar, but would be scratched by quartz, would be expressed by the number 6.5.

The pure metals are softer than their alloys. Hence it is that, for jewellery and coinage, gold and silver are alloyed with copper to increase their hardness.

The hardness of a body has no relation to its resistance to compression. Glass and diamond are much harder than wood, but the latter offers far greater resistance to the blow of a hammer. Hard bodies are often used for polishing-powders; for example, emery, pumice, and tripoli. Diamond, being the hardest of all bodies, can only be ground by means of its own powder.

95. **Temper.**—By sudden cooling after they have been raised to a high temperature, many bodies acquire great hardness. This operation is called *tempering*. All cutting instruments are made of tempered steel. There are, however, some few bodies upon which tempering produces quite a contrary effect. An alloy of one part of tin and four parts of copper, called *tamtam metal*, is ductile and malleable when rapidly cooled, but hard and brittle as glass when cooled slowly.

## BOOK III.

### ON LIQUIDS.

---

#### CHAPTER I.

##### HYDROSTATICS.

96. **Object of Hydrostatics.**—The science of *hydrostatics* treats of the conditions of the equilibrium of liquids, and of the pressures they exert, whether within their own mass or on the sides of the vessels in which they are contained.

The science which treats of the motion of liquids is *hydrodynamics*, and the application of the principles of this science to conducting and raising water in pipes is known by the name of *hydraulics*.

97. **General characters of liquids.**—It has been already seen (4) that liquids are bodies whose molecules are displaced by the slightest force. Their fluidity, however, is not perfect; there is always a sufficient adherence between their molecules to produce a greater or less viscosity.

Gases also possess fluidity, but in a higher degree than liquids. The distinction between the two forms of matter is that liquids are almost incompressible and are comparatively inexpandible, while gases are eminently compressible and expand spontaneously.

The fluidity of liquids is seen in the readiness with which they take all sorts of shapes. Their compressibility is established by the following experiment.

98. **Compressibility of liquids.**—From the experiment of the Florentine Academicians (13), liquids were for a long time regarded as being completely incompressible. Since then, researches have been made on this subject by various physicists, which have shown that liquids are really compressible.

The apparatus used for measuring the compressibility of liquids has been named the *piezometer* ( $\pi\acute{\iota}\epsilon\sigma\omega$ , I compress,  $\mu\acute{\epsilon}\tau\rho\omicron\nu$ , measure). That shown in fig. 60 is the form invented by Oersted as improved by MM. Despretz and Saigey; it consists of a strong glass cylinder, with very thick sides, and an internal diameter of about  $3\frac{1}{4}$  inches. The base of the cylinder is firmly cemented into a wooden foot, and on its upper part is fitted a metallic cylinder closed by a cap which can be unscrewed. In this cap there is a funnel, R, for introducing water into the cylinder, and a small barrel hermetically closed by a piston, which is moved by a screw, P.

In the inside of the apparatus there is a glass vessel, A, containing the

liquid to be compressed.



Fig. 60.

The upper part of this vessel terminates in a capillary tube, which dips under mercury, O. This tube has been previously divided into parts of equal capacity, and it has been determined how many of these parts the vessel A contains. The latter is ascertained by finding the weight, P, of the mercury which the reservoir, A, contains, and the weight,  $p$ , of the mercury contained in a certain number of divisions,  $n$ , of the capillary tube. If N be the number of divisions of the small tube contained in the whole reservoir, we have  $\frac{N}{n} = \frac{P}{p}$ , from which the value of N is obtained. There is further a *manometer*. This is a glass tube, B, containing air, closed at one end, and the other end of which dips under mercury. When there is no pressure on the water in the cylinder, the tube B is completely full of air; but when the water within the cylinder is compressed by means of the screw P, the pressure is transmitted to the mercury, which rises in the tube, compressing the air which it contains. A graduated scale fixed on the side of the tube shows the reduction of volume, and this reduction of volume indicates the pressure exerted on the liquid in the cylinder, as will be seen in speaking of the manometer.

In making the experiment, the vessel A is filled with the liquid to be compressed, and the end dipped under the mercury. By means of the funnel R the cylinder is entirely filled with water. The screw P being then turned the piston moves downwards, and the pressure exerted upon the water is transmitted to the mercury and the air; in consequence of which the mercury rises in the tube B, and also in the capillary tube. The ascent of mercury in the capillary tube shows that the liquid in the vessel A has diminished in volume, and gives the amount of its compression, for the capacity of the whole vessel A in terms of the graduated divisions on the capillary tube has been previously determined.

In his first experiments, Oersted assumed that the capacity of the vessel A remained the same, its sides being compressed both internally and externally by the liquid. But mathematical analysis proves that this capacity diminishes in consequence of the external and internal pressures. Colladon and Sturm have made some experiments allowing for this change of capacity, and have found that for a pressure equal to that of the atmosphere, mercury experiences a compression of 0.000005 parts of its original volume; water a compression of 0.00005, and ether a compression of 0.000133 parts of its original bulk. The compressibility of sea water is only about 0.000044: it is not materially denser even at great depths; thus at the depth of a mile its density would only be about  $\frac{1}{130}$ th the greater.

For *water and mercury* it was also found that within certain limits the decrease of volume is proportional to the pressure.

Whatever be the pressure to which a liquid has been subjected, experiment shows that as soon as the pressure is removed the liquid regains its original volume, from which it is concluded that *liquids are perfectly elastic*.

**99. Equality of pressures. Pascal's law.**—By considering liquids as perfectly fluid, and assuming them to be uninfluenced by the action of gravity, the following law has been established. It is often called Pascal's law, for it was first enunciated by him.

*Pressure exerted anywhere upon a mass of liquid is transmitted undiminished in all directions, and acts with the same force on all equal surfaces, and in a direction at right angles to those surfaces.*

To get a clearer idea of the truth of this principle, let us conceive a vessel of any given form in the sides of which are placed various cylindrical apertures, all of the same size, and closed by movable pistons. Let us, further, imagine this vessel to be filled with liquid and unaffected by the action of gravity; the pistons will, obviously, have no tendency to move. If now upon the piston A (fig. 61), which has a surface  $a$ , a weight of  $P$  pounds be placed, it will be pressed inwards, and the pressure will be transmitted to the internal faces of each of the pistons B, C, D, and E, which will each be forced outwards by a pressure  $P$ , their surfaces being equal to that of the first piston. Since each of the pistons undergoes a pressure  $P$ , equal to that on A, let us suppose two of the pistons united so as to constitute a surface  $2a$ , it will have to support a pressure  $2P$ . Similarly, if the piston were equal to  $3a$ , it would experience a pressure of  $3P$ ; and if its area were 100 or 1,000 times that of  $a$ , it would sustain a pressure of 100 or 1,000 times  $P$ . In other words, the pressure on any part of the internal walls of the vessel would be proportional to the surface.

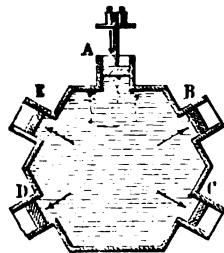

Fig. 61.

The principle of the equality of pressure is assumed as a consequence of the constitution of fluids. By the following experiment it can be shown that

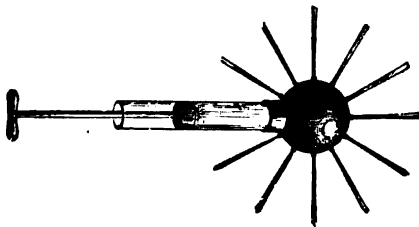

Fig. 62.

pressure is transmitted in all directions, although it cannot be shown that it is equally transmitted. A cylinder provided with a piston is fitted into a hollow sphere (fig. 62), in which small cylindrical jets are placed perpen-



dicular to the sides. The sphere and the cylinder being both filled with water, when the piston is moved the liquid spouts forth from all the orifices, and not merely from that which is opposite to the piston.

The reason why a satisfactory quantitative experimental demonstration of the principle of the equality of pressure cannot be given is, that the influence of the weight of the liquid and of the friction of the pistons cannot be eliminated.

Yet an approximate verification may be effected by the experiment represented in fig. 63. Two cylinders of different diameters are joined by a tube and filled with water. On the surface of the liquid are two pistons P and p, which hermetically close the cylinders, but move without friction.

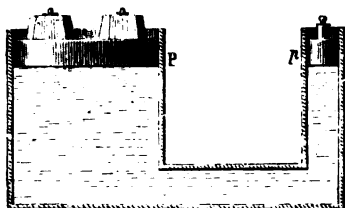

Fig. 63.

Let the area of the large piston be, for instance, thirty times that of the smaller one. That being assumed, let a weight, say of two pounds, be placed upon the small piston, this pressure will be transmitted to the water and to the large piston, and as this pressure amounts to two pounds on each portion of its surface equal to that of the small piston, the large piston must be exposed to an upward pressure thirty times as much, or of sixty pounds. If now this weight is placed upon the large piston, both will remain in equilibrium; but if the weight is greater or less, this is no longer the case. If  $S$  and  $s$  are the areas of the large and small piston respectively, and  $P$  and  $p$  the corresponding loads, then,  $\frac{P}{p} = \frac{S}{s}$ ; whence  $P = \frac{pS}{s}$ .

It is important to observe that in speaking of the transmission of pressures to the sides of the containing vessel, these pressures must always be supposed to be perpendicular to the sides; for any oblique pressure may be decomposed into two others, one at right angles to the side, and the other acting parallel with the side; but as the latter has no action on the side, the perpendicular pressure is the only one to be considered.

#### PRESSURE PRODUCED IN LIQUIDS BY GRAVITY.

100. **Vertical downward pressure, its laws.**—Any given liquid being in a state of rest in a vessel, if we suppose it to be divided into horizontal layers of the same density, it is evident that each layer supports the weight of those above it. Gravity, therefore, produces internal pressures in the mass of a liquid which vary at different points. These pressures are submitted to the following general laws:—

- I. *The pressure in each layer is proportional to the depth.*
- II. *With different liquids and the same depth, the pressure is proportional to the density of the liquid.*
- III. *The pressure is the same at all points of the same horizontal layer.*

The first two laws are self-evident; the third necessarily follows from the first and from Pascal's principle.

Meyer has found, by direct experiments, that pressures are transmitted through liquids contained in tubes with the same velocity as that with which sound travels under the same circumstances.

**101. Vertical upward pressure.**—The pressure which the upper layers of a liquid exert on the lower layers causes them to exert an equal reaction in an upward direction, a necessary consequence of the principle of transmission of pressure in all directions. This upward pressure is termed the *buoyancy* of liquids; it is very sensible when the hand is plunged into a liquid, more especially one of great density, like mercury.

The following experiment (fig. 64) serves to exhibit the upward pressure of liquids. A large open glass tube A, one end of which is ground, is fitted with a ground-glass disc, O, or still better with a thin card or piece of mica, the weight of which may be neglected. To the disc is fitted a string, C, by which it can be held against the bottom of the tube. The whole is then immersed in water, and now the disc does not fall, although no longer held by the string; it is consequently kept in its position by the upward pressure of the water. If water be now slowly poured into the tube, the disc will only sink when the height of the water inside the tube is equal to the height outside. It follows thence that the upward pressure on the disc is equal to the pressure of a column of water, the base of which is the internal section of the tube A, and the height the distance from the disc to the upper surface of the liquid. Hence the *upward pressure of liquids at any point is governed by the same laws as the downward pressure.*



Fig. 64.

**102. Pressure is independent of the shape of the vessel.**—The pressure exerted by a liquid, in virtue of its weight, on any portion of the liquid, or on the sides of the vessel in which it is contained, depends on the depth and density of the liquid, but *is independent of the shape of the vessel and of the quantity of the liquid.*

This principle, which follows from the law of the equality of pressure, may be experimentally demonstrated by many forms of apparatus. The following is the one most frequently used, and is due to Haldat. It consists of a bent tube, ABC (fig. 65), at one end of which, A, is fitted a stop-cock, in which can be screwed two vessels, M and P, of the same height, but different in shape and capacity, the first being conical, and the other nearly cylindrical. Mercury is poured into the tube, ABC, until its level nearly reaches A. The vessel M is then screwed on and filled with water. The pressure of the water acting on the mercury causes it to rise in the tube C, and its height may be marked by means of a little collar, *a*, which slides up and down the tube. The level of the water in M is also marked by means of the movable rod *o*. When this is done, M is emptied by means of the stop-cock, unscrewed and replaced by P. When water is now poured in this, the mercury, which had resumed its original level in the tube ABC, again rises in C, and when the water in P has the same height as it had in M, which is indicated by the rod *o*, the mercury will have risen to the

height it had before, which is marked by the collar *a*. Hence the pressure on the mercury in both cases is the same. This pressure is therefore independent of the shape of the vessels, and, consequently, also of the quantity

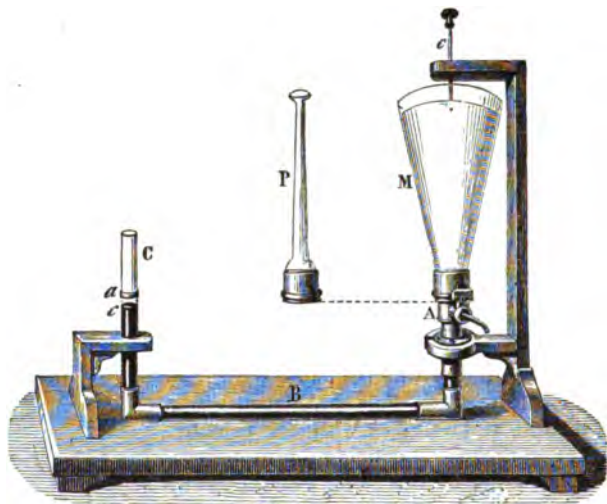

Fig. 65.

of liquid. The base of the vessel is obviously the same in both cases; it is the surface of the mercury in the interior of the tube *A*.

Another mode of demonstrating this principle is by means of an apparatus devised by Masson. In this (fig. 66) the pressure of the water contained in the vessel *M* is not exerted upon the column of mercury, as in that of Haldat, but on a small disc or stop *a*, which closes a tubulure *c*, on which is screwed the vessel *M*. The disc is not fixed to the tubulure, but is sustained by a thread attached to the end of a scale-beam. At the other end is a pan in which weights can be placed until they counterbalance the pressure exerted by the water on the stop. The vessel *M* being emptied is unscrewed, and replaced by the narrow tube *O*. This being filled to the same height as the large vessel, which is observed by means of the mark *o*, it will be observed that to keep the disc in its place just the same weight must be placed in the pan as before, which leads, therefore, to the same conclusion as does Haldat's experiment. The same result is obtained if, instead of the vertical tube *P*, the oblique tube *Q* be screwed to the tubulure.

From a consideration of these principles it will be readily seen that a very small quantity of water can produce considerable pressures. Let us imagine any vessel, a cask, for example, filled with water and with a long narrow tube tightly fitted into the side. If water is poured into the tube, there will be a pressure on the bottom of the cask equal to the weight of a column of water whose base is the bottom itself, and whose height is equal to that of the water in the tube. The pressure may be made as great as we

please ; by means of a narrow thread of water forty feet high, Pascal succeeded in bursting a very solidly constructed cask.

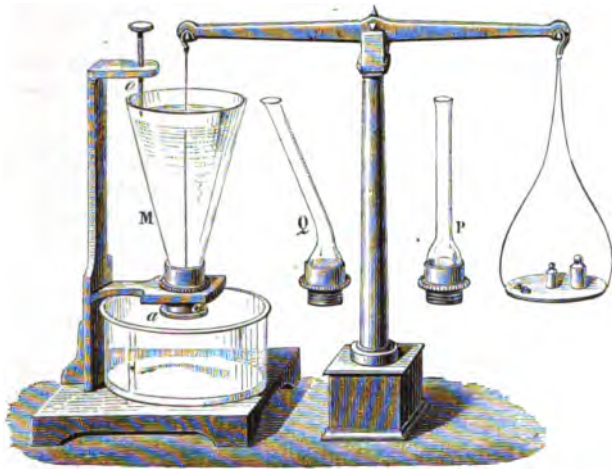

Fig. 66.

The toy known as the *hydrostatic bellows* depends on the same principle, and we shall shortly see a most important application of it in the hydraulic press.

From the principle just laid down, the pressures produced at the bottom of the sea may be calculated. It will be presently demonstrated that the pressure of the atmosphere is equal to that of a column of sea-water about thirty-three feet high. At sea the lead has frequently descended to a depth of thirteen thousand feet ; at the bottom of some seas, therefore, there must be a pressure of four hundred atmospheres.

**103. Pressure on the sides of vessels.**—Since the pressure caused by gravity in the mass of a liquid is transmitted in every direction, according to the general law of the transmission of fluid pressure, it follows that at every point of the side of any vessel a pressure is exerted, at right angles to the side, which we will suppose to be plane. The resultant of all these pressures is the total pressure on the sides. But since these pressures increase in proportion to the depth, and also in proportion to the horizontal extent of their side, their resultant can only be obtained by calculation, which shows that the total pressure on any given portion of the side *is equal to the weight of a column of liquid, which has this portion of the side for its base, and whose height is the vertical distance from the centre of gravity of the portion to the surface of the liquid.* If the side of a vessel is a curved surface the same rule gives the pressure on the surface, but the total pressure is no longer the resultant of the fluid pressures.

The point in the side supposed plane, at which the resultant of all the pressure is applied, is called the *centre of pressure*, and is always below the centre of gravity of the side. For if the pressures exerted at different parts of the plane side were equal, the point of application of their resultant, the

centre of pressure, would obviously coincide with the centre of gravity of the side. But since the pressure increases with the depth, the centre of pressure is necessarily below the centre of gravity. This point is determined by calculation, which leads to the following results :—

i. With a rectangular side whose upper edge is level with the water, the centre of pressure is at two-thirds of the line which joins the middle of the horizontal sides measured from the top.

ii. With a triangular side whose base is horizontal, and coincident with the level of the water, the centre of pressure is at the middle of the line which joins the vertex of the triangle with the middle of the base.

iii. With a triangular side whose vertex is level with the water, the centre of pressure is in the line joining the vertex and the middle of the base, and at three-fourths of the distance of the latter from the vertex.

104. **Hydrostatic paradox.**—We have already seen that the pressure on the bottom of a vessel depends neither on the form of the vessel nor on the quantity of the liquid, but simply on the height of the liquid above the bottom. But the pressure thus exerted must not be confounded with the pressure which the vessel itself exerts on the body which supports it. The latter is always equal to the combined weight of the liquid and the vessel in which it is contained, while the former may be either smaller or greater than this weight, according to the form of the vessel. This fact is usually termed the *hydrostatic paradox*, because at first sight it appears paradoxical.

CD (fig. 67) is a vessel composed of two cylindrical parts of unequal diameters, and filled with water to *a*. From what has been said before, the

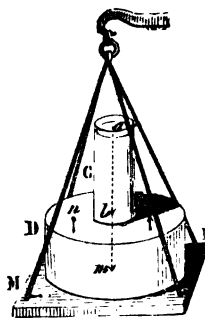

Fig. 67.

bottom of the vessel CD supports the same pressure as if its diameter were everywhere the same as that of its lower part; and it would at first sight seem that the scale MN of the balance, in which the vessel CD is placed, ought to show the same weight as if there had been placed in it a cylindrical vessel having the same height of water, and having the diameter of the part D. But the pressure exerted on the bottom of the vessel is not all transmitted to the scale MN; for the *upward* pressure upon the surface *no* of the vessel is precisely equal to the weight of the *extra* quantity of water which a cylindrical vessel would contain, and balances an equal portion of the *downward* pressure on *m*. Consequently, the pressure on the plate MN is simply equal to the weight of the vessel CD and of the water which it contains.

#### CONDITIONS OF THE EQUILIBRIUM OF LIQUIDS.

105. **Equilibrium of a liquid in a single vessel.**—In order that a liquid may remain at rest in a vessel of any given form, it must satisfy the two following conditions :—

I. *Its surface must be everywhere perpendicular to the resultant of the forces which act on the molecules of the liquid.*

II. *Every molecule of the mass of the liquid must be subject in every direction to equal and contrary pressures.*

The second condition is self-evident ; for if, in two opposite directions, the pressures exerted on any given molecule were not equal and contrary, the molecule would be moved in the direction of the greater pressure, and there would be no equilibrium. Thus the second condition follows from the principle of the equality of pressures, and from the reaction which all pressure causes on the mass of liquids.

To prove the first condition, let us suppose that  $mp$  is the resultant of all the forces acting upon any molecule  $m$  on the surface (fig. 68), and that this surface is inclined in reference to the force  $mp$ . The latter can consequently be decomposed into two forces,  $mq$  and  $mf$ ; the one perpendicular to the surface of the liquid and the other to the direction  $mp$ . Now the first force,  $mq$ , would be destroyed by the resistance of the liquid, while the second would move the molecule in the direction  $mf$ , which shows that the equilibrium is impossible.

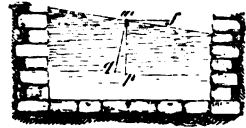

Fig. 68.

If gravity be the force acting on the liquid, the direction  $mp$  is vertical ; hence, if the liquid is contained in a basin or vessel of small extent, the surface ought to be plane and horizontal (68), because then the direction of gravity is the same in every point. But the case is different with liquid surfaces of greater extent, like the ocean. The surface will be perpendicular to the direction of gravity : but as this changes from one point to another, and always tends towards a point near the centre of the earth, it follows that the direction of the surface of the ocean will change also, and assume a nearly spherical form.

**106. Equilibrium of the same liquid in several communicating vessels.**—When several vessels of any given form communicate with each other, there will be equilibrium when the liquid in each vessel satisfies the two preceding conditions (105), and further, *when the surfaces of the liquids in all the vessels are in the same horizontal plane.*

In the vessels ABCD (fig. 69), which communicate with each other, let us consider any transverse section of the tube  $mn$ ; the liquid can only remain in equilibrium as long as the pressures which this section supports from  $m$  in the direction of  $n$ , and from  $n$  in the direction of  $m$ , are equal and opposite. Now it has been already proved that these pressures are respectively equal to the weight of a column of water, whose base is the supposed section, and whose height is the distance from the centre of gravity of this section to the surface of the liquid. If we conceive, then, a horizontal plane,  $mn$ , drawn through the centre of gravity of this section, it will be seen that there will only be equilibrium as long as the height of the liquid above this plane is the same in each vessel, which demonstrates the principle enunciated.

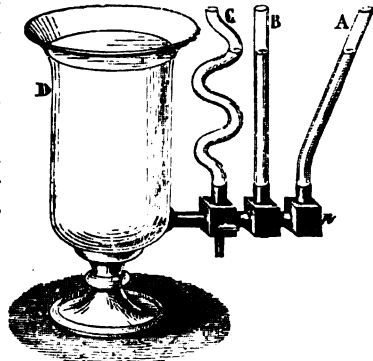

Fig. 69.

107. **Equilibrium of superposed liquids.**—In order that there should be equilibrium when several heterogeneous liquids are superposed in the same vessel, each of them must satisfy the conditions necessary for a single liquid (105); and further, *there will be stable equilibrium only when the liquids are arranged in the order of their decreasing densities from the bottom upwards.*

The last condition is experimentally demonstrated by means of the *phial of four elements*. This consists of a long narrow bottle containing mercury, water saturated with carbonate of potass, alcohol coloured red, and petroleum. When the phial is shaken the liquids mix, but when it is allowed to rest they separate; the mercury sinks to the bottom, then comes the water, then the alcohol, and then the petroleum. This is the order of the decreasing densities of the bodies. The water is saturated with carbonate of potass to prevent its mixing with the alcohol.

This separation of the liquids is due to the same cause as that which enables solid bodies to float on the surface of a liquid of greater density than their own. It is also on this account that fresh water, at the mouths of rivers, floats for a long time on the denser salt water of the sea; and it is for the same reason that cream, which is lighter than milk, rises to the surface.

108. **Equilibrium of two different liquids in communicating vessels.**—When two liquids of different densities, which do not mix, are contained in two communicating vessels, they will be in equilibrium when, in addition to the preceding principles, they are subject to the following: *that the heights above the horizontal surface of contact of two columns of liquid in equilibrium are in the inverse ratio of their densities.*

To show this experimentally, mercury is poured into a bent glass tube, *mn*, fixed against an upright wooden support (fig. 70), and then water is poured into one of the legs, *AB*. The column of water, *AB*, pressing on the mercury at *B*, lowers its level in the leg *AB*, and raises it in the other by a quantity, *CD*; so that if, when equilibrium is established, we imagine a horizontal plane, *BC*, to pass through *B*, the column of water in *AB* will balance the column of mercury *CD*. If the heights of these two columns are then measured, by means of the scales, it will be found that the height of the column of water is about  $13\frac{1}{2}$  times that of the height of the column of mercury. We shall presently see that the density of mercury is about  $13\frac{1}{2}$  times that of water, from which it follows that the heights are inversely as the densities.

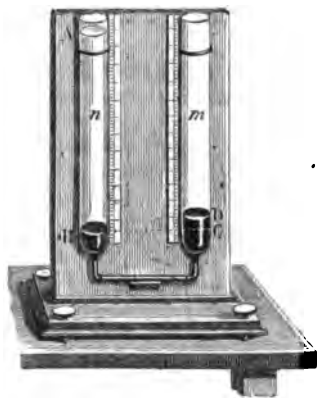

Fig. 70.

It may be added, that the equilibrium cannot exist unless there is a sufficient quantity of the heavier liquid for part of it to remain in *both legs* of the tube.

The preceding principle may be deduced by a very simple calculation. Let *d* and *d'* be the densities of water and mercury, and *h* and *h'* their re-

spective heights, and let  $g$  be the force of gravity. The pressure on B will be proportional to the density of the liquid, to its height, and to the force of gravity; on the whole, therefore, to the product  $dhg$ . Similarly, the pressure at C will be proportional to  $d'h'g$ . But in order to produce equilibrium,  $dhg$  must be equal to  $d'h'g$ , or  $dh = d'h'$ . This is nothing more than an algebraical expression of the above principle; for since the two products must always be equal,  $d'$  must be as many times greater than  $d$ , as  $h'$  is less than  $h$ .

In this manner the density of a liquid may be determined. Suppose one of the branches contained water and the other oil, and their heights were, respectively 15 inches for the oil, and 14 inches for the water. The density of water being taken as unity, and that of oil being called  $x$ , we shall have

$$15 \times x = 14 \times 1; \text{ whence } x = \frac{14}{15} = 0.933.$$

APPLICATIONS OF THE PRECEDING HYDROSTATIC PRINCIPLES.

109.—**Hydraulic press.**—The law of the equality of pressure has received a most important application in the *hydraulic press*, a machine by which

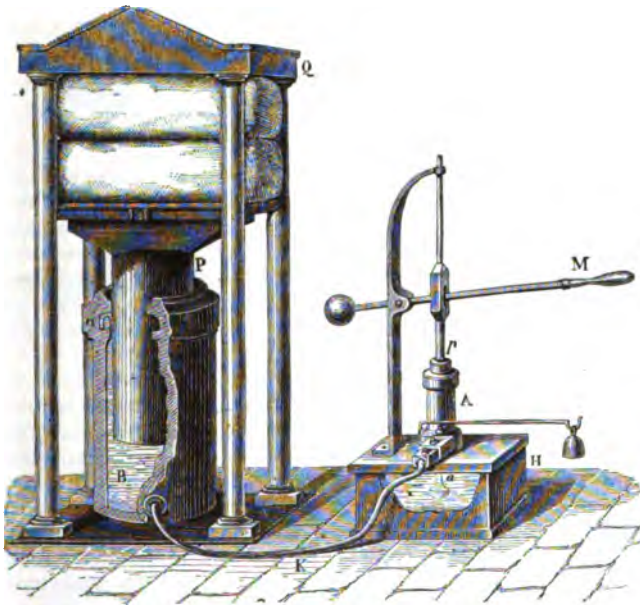

Fig. 71.

enormous pressures may be produced. Its principle is due to Pascal, but it was first constructed by Bramah in 1796.

It consists of a cylinder, B, with very strong thick sides (fig. 71), in which there is a cast-iron ram, P, working water-tight in the collar of the



cylinder. On the ram P there is a cast-iron plate on which the substance to be pressed is placed. Four strong columns serve to support and fix a second plate, Q.

By means of a leaden pipe, K, the cylinder, B, which is filled with water, communicates with a small force-pump, A, which works by means of a lever, M. When the piston of this pump  $\phi$  ascends, a vacuum is produced and the water rises in the tube  $a$ , at the end of which there is a rose, to prevent the entrance of foreign matters. When the piston  $\phi$  descends, it drives the water into the cylinder by the tube K.

Fig. 72 represents a section, on a larger scale, of the system of valves necessary in working the apparatus. The valve  $o$ , below the piston  $\phi$ , opens

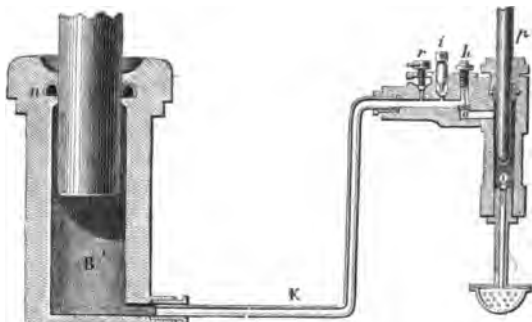

Fig. 72.

when the piston rises, and closes when it descends. The valve  $o$ , during this descent, is opened by the pressure of the water which passes by the pipe K. The valve  $i$  is a *safety valve*, held by a weight which acts on it by means of a lever. By weighting the latter to a greater or less extent the pressure can be regulated, for as soon as there is an upward pressure greater than that of the weight upon it, it opens and water escapes. A screw  $r$  serves to relieve the pressure, for when it is opened it affords a passage for the efflux of the water in the cylinder B.

A most important part is the leather collar,  $n$ , the invention of which by

Bramah removed the difficulties which had been experienced in making the large ram work water-tight when submitted to great pressures. It consists of a circular piece of stout leather, fig. 73, saturated with oil so as to be impervious to water, in the centre of which a circular hole is cut. This piece is bent, so that a section of it represents a reversed U, and is fitted into a groove  $n$  made in the neck of the cylinder. This collar being concave downwards, in proportion as the pressure increases, it fits the more tightly against the ram P on one side and the neck of the cylinder on the other, and quite prevents any escape of water.



Fig. 73.

The pressure which can be obtained by this press depends on the relation of the piston P to that of the piston  $\phi$ . If the former has a transverse section

fifty or a hundred times as large as the latter, the upward pressure on the large piston will be fifty or a hundred times that exerted upon the small one. By means of the lever *M* an additional advantage is obtained. If the distance from the fulcrum to the point where the power is applied is five times the distance from the fulcrum to the piston *p*, the pressure on *p* will be five times the power. Thus, if a man acts on *M* with a force of sixty pounds, the force transmitted by the piston *p* will be 300 pounds, and the force which tends to raise the piston *P* will be 30,000 pounds, supposing the section of *P* is a hundred times that of *p*.

The hydraulic press is used in all cases in which great pressures are required. It is used in pressing cloth and paper, in extracting the juice of beet-root, in compressing hay and cotton, in expressing oil from seeds, and in bending iron plates; it also serves to test the strength of cannon, of steam boilers, and of chain cables. The parts composing the tubular bridge which spans the Menai Straits were raised by means of an hydraulic press. The cylinder of this machine, the largest which has ever been constructed, was nine feet long and twenty-two inches in internal diameter; it was capable of raising a weight of two thousand tons.

110. **Water level.**—The *water level* is an application of the conditions of equilibrium in communicating vessels. It consists of a metal tube bent at both ends, in which are fitted glass tubes *D* and *E* (fig. 71). It is placed on

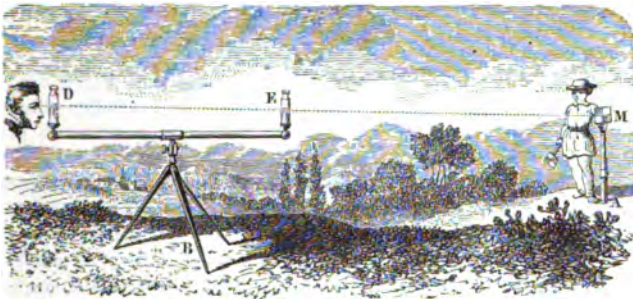

Fig. 74.

a tripod, and water poured in until it rises in both legs. When the liquid is at rest, the level of the water in both tubes is the same—that is, they are both in the same horizontal plane.

This instrument is used in levelling, or ascertaining how much one point is higher than another. If, for example, it is desired to find the difference between the heights of *B* and *A*, a *levelling-staff* is fixed on the latter place. This staff consists of a rule formed of two sliding pieces of wood, and supporting a piece of tin plate *M*, in the centre of which there is a mark. This staff being held vertically at *A*, an observer looks at it through the level along the surfaces *D* and *E*, and directs the holder to raise or lower the slide until the mark is in the prolongation of the line *DE*. The height *AM* is then measured, and subtracting it from the height of the level, the height of the point *A* above *B* is obtained.

111. **Spirit level.**—The *spirit level* is both more delicate and more accurate than the water level. It consists of a glass tube, AB (fig. 75), very slightly curved; that is, the tube, instead of being a true cylinder as it seems to be, is in fact slightly curved in such a manner that its axis is an arc of a circle of very large radius; it is filled with spirit with the exception of a

Fig. 75.

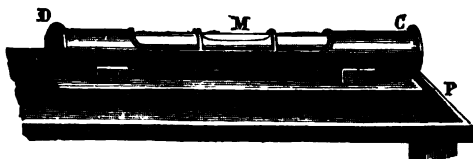

Fig. 76.

bubble of air, which tends to occupy the highest part. The tube is placed in a brass case, CD (fig. 76), which is so arranged that when it is in a perfectly horizontal position the bubble of air is exactly between the two points marked in the case.

To take levels with this apparatus, it is fixed on a telescope, which can consequently be placed in a horizontal position.

112. **Artesian wells.**—All natural collections of water exemplify the tendency of water to find its level. Thus, a group of lakes, such as the great lakes of North America, may be regarded as a number of vessels in communication, and consequently the waters tend to maintain the same level in all. This, too, is the case with the source of a river and the sea, and, as the latter is on the lower level, the river continually flows down to the sea along its bed, which is, in fact, the means of communication between the two.

Perhaps the most striking instance of this class of natural phenomena is that of *artesian wells*. These wells derive their name from the province of Artois, where it has long been customary to dig them, and from whence their use in other parts of France and Europe was derived. It seems, however, that at a very remote period wells of the same kind were dug in China and Egypt.

To understand the theory of these wells, it must be premised that the strata composing the earth's crust are of two kinds: the one *permeable* to water, such as sand, gravel, etc.; the other *impermeable*, such as clay. Let us suppose, then, a geographical basin of greater or less extent, in which the two impermeable layers AB, CD (fig. 77), enclose between them a permeable layer KK. The rain-water falling on the part of this layer which comes to the surface, which is called the *outcrop*, will filter through it, and following the natural fall of the ground will collect in the hollow of the basin, whence it cannot escape owing to the impermeable strata above and below it. If, now, a vertical hole, I, be sunk down to the water-bearing stratum, the water striving to regain its level will spout out to a height which depends on

the difference between the levels of the outcrop and of the point at which the perforation is made.

The waters which feed artesian wells often come from a distance of sixty or seventy miles. The depth varies in different places. The well

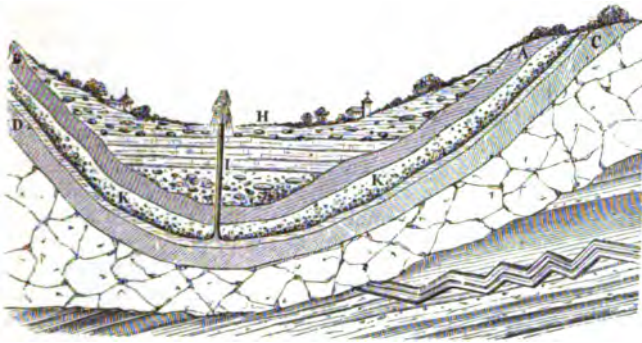

Fig. 77.

at Grenelle is 1,800 feet deep ; it gives 656 gallons of water in a minute and is one of the deepest and most abundant which have been made. The temperature of the water is  $27^{\circ}$  C. It follows from the law of the increase of temperature with the increasing depth below the surface of the ground, that, if this well were 210 feet deeper, the water would have all the year round a temperature of  $32^{\circ}$  C., that is, the ordinary temperature of baths.

#### BODIES IMMERSED IN LIQUIDS.

**113. Pressure supported by a body immersed in a liquid.**—When a solid is immersed in a liquid, every portion of its surface is submitted to a perpendicular pressure which increases with the depth. If we imagine all these pressures decomposed into horizontal and vertical pressures; the first set are in equilibrium. The vertical pressures are obviously unequal, and will tend to move the body upwards.

Let us imagine a cube immersed in a mass of water (fig. 78), and that four of its edges are vertical. The pressures upon the four vertical faces being, clearly, in equilibrium, we need only consider the pressures exerted on the horizontal faces A and B. The first is pressed downwards by a column of water, whose base is the face A, and whose height is AD, the lower face B is pressed upwards by the weight of a column of water whose base is the face itself, and whose height is BD (101). The cube, therefore, is urged upwards by a force equal to the difference between these two pressures, which latter is manifestly equal to the weight of a column of water having the same base and the same height as this cube. *Consequently, this upward*

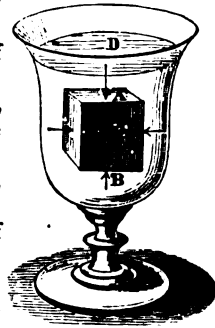

Fig. 78.

*pressure is equal to the weight of the volume of water displaced by the immersed body.*

We shall readily see from the following reasoning that every body immersed in a liquid is pressed upwards by a force equal to the weight of the displaced liquid. In a liquid at rest, let us suppose a portion of it of any given shape, regular or irregular, to become solidified, without either increase or decrease of volume. The liquid thus solidified will remain at rest, and therefore must be acted upon by a force equal to its weight, and acting vertically upwards through its centre of gravity; for otherwise motion would ensue. If in the place of the solidified water we imagine a solid of another substance of exactly the same volume and shape, it will necessarily receive the same pressures from the surrounding liquid as the solidified portion did; hence, like the latter, it will sustain the pressure of a force acting vertically upwards through the centre of gravity of the displaced liquid, and equal to the weight of the displaced liquid. If, as almost invariably happens, the liquid is of uniform density, the centre of gravity of the displaced liquid means the centre of gravity of the immersed part of the body *supposed to be of uniform density*. This distinction is sometimes of importance; for example, if a sphere is composed of a hemisphere of iron and another of wood, its centre of gravity would not coincide with its geometrical centre; but if it were placed under water, the centre of gravity of the displaced water would be at the geometrical centre, that is, will have the same position as the centre of gravity of the sphere if of uniform density.

**114. Principle of Archimedes.**—The preceding principles prove that every body immersed in a liquid is submitted to the action of two forces: gravity which tends to lower it, and the buoyancy of the liquid which tends to raise it with a force equal to the weight of the liquid displaced. The weight of the body is either totally or partially overcome by this buoyancy, from which it is concluded that *a body immersed in a liquid loses a part of its weight equal to the weight of the displaced liquid.*

This principle, which is the basis of the theory of immersed and floating bodies, is called the principle of Archimedes, after the discoverer. It may be shown experimentally by means of the *hydrostatic balance* (fig. 79). This is an ordinary balance, each pan of which is provided with a hook; the beam can be raised by means of a toothed rack, which is worked by a little pinion, C. A catch, D, holds the rack when it has been raised. The beam being raised, a hollow brass cylinder, A, is suspended to one of the pans, and below this a solid cylinder, B, whose volume is exactly equal to the capacity of the first cylinder; lastly, an equipoise is placed in the other pan. If now the hollow cylinder A be filled with water the equilibrium is disturbed; but if at the same time the beam is lowered so that the solid cylinder B becomes immersed in a vessel of water placed beneath it, the equilibrium will be restored. By being immersed in water the cylinder B loses a portion of its weight equal to that of the water in the cylinder A. Now as the capacity of the cylinder A is exactly equal to the volume of the cylinder B, the principle which has been before laid down is proved.

**115. Determination of the volume of a body.**—The principle of Archimedes furnishes a method for obtaining the volume of a body of any shape, provided it is not soluble in water. The body is suspended by a fine

thread to the hydrostatic balance, and is weighed first in the air, and then in distilled water at  $4^{\circ}$  C. The loss of weight is the weight of the displaced water, from which the volume of the displaced water is readily calculated. But this volume is manifestly that of the body itself. Suppose, for example,

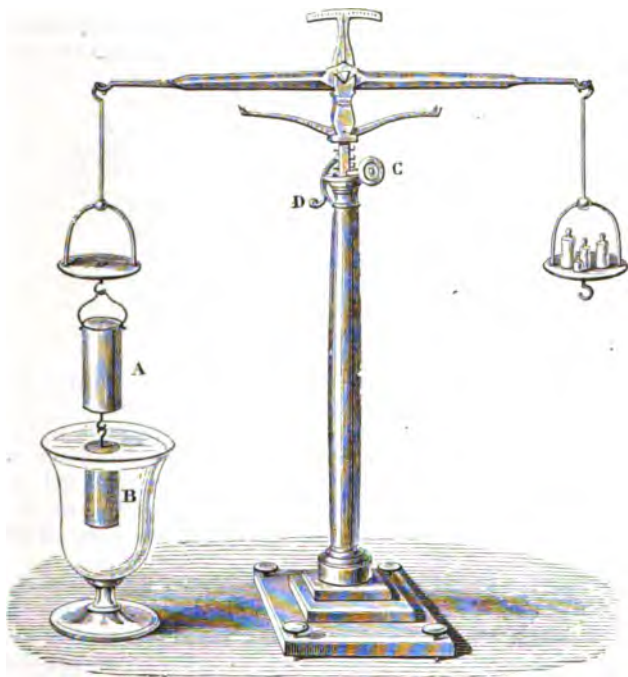

Fig. 79.

155 grammes is the loss of weight. This is consequently the weight of the displaced water. Now it is known that a gramme is the weight of a cubic centimetre of water at  $4^{\circ}$ ; consequently, the volume of the body immersed is 155 cubic centimetres.

116. **Equilibrium of floating bodies.**—A body when floating is acted on by two forces, namely, its weight, which acts vertically downwards through its centre of gravity, and the resultant of the fluid pressures, which (113) acts vertically upwards through the centre of gravity of the fluid displaced; but if the body is at rest these two forces must be equal and act in opposite directions; whence follow the conditions of equilibrium, namely:—

- i. *The floating body must displace a volume of liquid whose weight equals that of the body.*
- ii. *The centre of gravity of the floating body must be in the same vertical line with that of the fluid displaced.*

Thus, in fig. 80, if C is the centre of gravity of the body and G that of

the displaced fluid, the line  $GC$  must be vertical, since when it is so the weight of the body and the fluid pressure will act in opposite directions along the same line, and will be in equilibrium if equal. It is convenient, with reference to the subject of the present article, to speak of the line  $CG$  produced as the axis of the body.

Next let it be enquired whether the equilibrium be stable or unstable. Suppose the body to be turned through a small angle (fig. 81) so that the

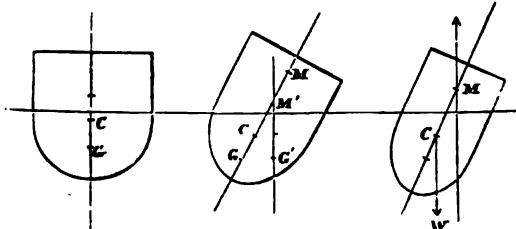

Fig. 80.

Fig. 81.

Fig. 82.

axis takes a position inclined to the vertical. The centre of gravity of the displaced fluid will no longer be  $G$ , but some other point  $G'$ . And since the fluid pressure acts vertically upwards through  $G'$ , its direction will cut the axis in some point  $M'$ , which will generally have different positions according as the inclination of the axis to the vertical is greater or smaller. If the angle is indefinitely small,  $M'$  will have a definite position  $M$ , which always admits of determination, and is called the *metacentre*.

If we suppose  $M$  to be above  $C$ , an inspection of fig. 82 will show that when the body has received an indefinitely small displacement the weight of the body  $W$  and the resultant of the fluid pressures  $R$  tend to bring the body back to its original position, that is, in this case the equilibrium is stable (71). If, on the contrary,  $M$  is below  $C$ , the forces tend to cause the axis to deviate farther from the vertical, and the equilibrium is unstable. Hence the rule,

iii. *The equilibrium of a floating body is stable or unstable according as the metacentre is above or below the centre of gravity.*

The determination of the metacentre can rarely be affected except by

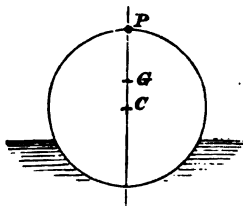

Fig. 83.

means of a somewhat difficult mathematical process. When, however, the form of the immersed part of a body is spherical it can be readily determined, for since the fluid pressure at each point converges to the centre, and continues to do so when the body is slightly displaced, their resultant must in all cases pass through the centre, which is therefore the metacentre. To illustrate this: let a spherical body float on the surface of a liquid (fig. 83), then, its centre of gravity and the metacentre both coinciding with the geometrical centre  $C$ , its equilibrium is neutral (71); now suppose a small heavy body to be fastened at  $P$ , the

summit of the vertical diameter. The centre of gravity will now be at some point G above C. Consequently, the equilibrium is unstable, and the sphere, left to itself, will instantly turn over and will rest when P is the lower end of a vertical diameter.

On investigating the position of the metacentre of a cylinder, it is found that when the ratio of the radius to the height is greater than a certain quantity, the position of stable equilibrium is that in which the axis is vertical; but if it be less than that quantity, the equilibrium is stable when the axis is horizontal. For this reason the stump of a tree floats lengthwise, but a thin disc of wood floats flat on the water.

Hence, also, if it is required to make a cylinder of moderate length float with its axis vertical, it is necessary to load it at the lower end. By so doing its centre of gravity is brought below the metacentre.

The determination of the metacentre and of the centre of gravity is of great importance in the stowage of vessels, for on their relative positions the stability depends.

117. **Cartesian diver.**—The different effects of suspension, immersion, and floating are reproduced by means of a well-known hydrostatic toy, the *Cartesian diver* (fig. 84). It consists of a glass cylinder nearly full of water, on the top of which a brass cap, provided with a piston, is hermetically fitted. In the liquid there is a little porcelain figure attached to a hollow glass ball *a*, which contains air and water, and floats on the surface. In the lower part of this ball there is a little hole by which water can enter or escape, according as the air in the interior is more or less compressed. The quantity of water in the globe is such that very little more is required to make it sink. If the piston be slightly lowered, the air is compressed, and this pressure is transmitted to the water of the vessel and the air in the bulb. The consequence is, that a small quantity of water penetrates into the bulb, which therefore becomes heavier and sinks. If the pressure is relieved, the air in the bulb expands, expels the excess of water which had entered it, and the apparatus, being now lighter, rises to the surface. The experiment may also be made by replacing the brass cap and piston by a cover of sheet india-rubber, which is tightly tied over the mouth; when this is pressed by the hand the same effects are produced.



Fig. 84.

118. **Swimming-bladder of fishes.**—Most fishes have an air-bladder below the spine, which is called the *swimming-bladder*. The fish can compress or dilate this at pleasure by means of a muscular effort, and produce the same effects as those just described—that is, it can either rise or sink in water.

119. **Swimming.**—The human body is lighter, on the whole, than an equal volume of water; it consequently floats on the surface and still better



in sea-water, which is heavier than fresh water. The difficulty in swimming consists not so much in floating, as in keeping the head above water, so as to breathe freely. In man the head is heavier than the lower parts, and consequently tends to sink, and hence swimming is an art which requires to be learned. With quadrupeds, on the contrary, the head being less heavy than the posterior parts of the body, remains above water without any effort, and these animals therefore swim naturally.

#### SPECIFIC GRAVITY—HYDROMETERS.

120. **Determination of specific gravities.**—It has been already explained (24) that the specific gravity of a body, whether solid or liquid, is the number which expresses the relation of the weight of a given volume of this body, to the weight of the same volume of distilled water at a temperature of 4°. In order, therefore, to calculate the specific gravity of a body, it is sufficient to determine its weight and that of an equal volume of water, and then to divide the first weight by the second : the quotient is the specific gravity of the body.

Three methods are commonly used in determining the specific gravities of solids and liquids. These are, 1st, the method of the hydrostatic balance ; 2nd, that of the hydrometer ; and 3rd, the specific gravity flask. All three, however, depend on the same principle, that of first ascertaining the weight of a body, and then that of an equal volume of water. We shall first apply these methods to determining the specific gravity of solids, and then to the specific gravity of liquids.

121. **Specific gravity of solids.**—i. *Hydrostatic balance.* To obtain the specific gravity of a solid by the hydrostatic balance (fig. 79), it is first

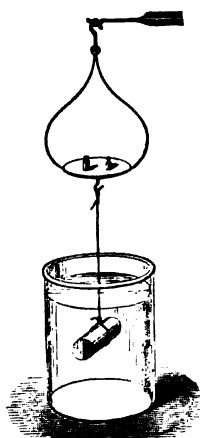

Fig. 85.

weighed in the air, and is then suspended to the hook of the balance and weighed in water (fig. 85). The loss of weight which it experiences is, according to Archimedes' principle, the weight of a volume of water equal to its own volume ; consequently, dividing the weight in air by the loss of weight in water, the quotient is the specific gravity required. If  $P$  is the weight of the body in air,  $P'$  its weight in water, and  $D$  its specific gravity,  $P - P'$  being the weight of the displaced water, we have  $D = \frac{P}{P - P'}$ .

It may be observed that though the weighing is performed in air, yet, strictly speaking, the quantity required is the weight of the body *in vacuo*, and when great accuracy is required, it is necessary to apply to the observed weights a correction for the weights of the unequal volumes of air displaced by the substance, and the weights in the other scale pan. The water in which bodies are weighed is supposed to be distilled water at a standard temperature.

ii. *Nicholson's Hydrometer.*—The apparatus consists of a hollow metal

cylinder B (fig. 86), to which is fixed a cone C, loaded with lead. The object of the latter is to bring the centre of gravity below the metacentre, so the cylinder may float with its axis vertical. At the top is a stem, terminated by a pan, in which is placed the substance whose specific gravity is to be determined. On the stem a standard point,  $o$ , is marked.

The apparatus stands partly out of the water, and the first step is to ascertain the weight which must be placed in the pan in order to make the hydrometer sink to the standard point  $o$ . Let this weight be 125 grains, and let sulphur be the substance whose specific gravity is to be determined. The weights are then removed from the pan, and replaced by a piece of sulphur which weighs less than 125 grains, and weights added until the hydrometer is again depressed to the standard,  $o$ . If, for instance, it has been necessary to add 55 grains, the weight of the sulphur is evidently the difference between 125 and 55 grains, that is, 70 grains. Having thus determined the weight of the sulphur in air, it is now only necessary to ascertain the weight of an equal volume of water. To do this, the piece of sulphur is placed in the lower pan C at  $m$ , as represented in the figure. The whole weight is not changed, nevertheless the hydrometer no longer sinks to the standard; the sulphur, by immersion, has lost a part of its weight equal to that of the water displaced. Weights are added to the upper pan until the hydrometer sinks again to the standard. This weight, 34.4 grains, for example, represents the weight of the volume of water displaced; that is, of the volume of water equal to the volume of the sulphur. It is only necessary, therefore, to divide 70 grains, the weight in air, by 34.4 grains, and the quotient 2.03 is the specific gravity.

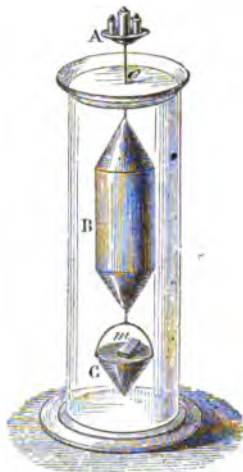

Fig. 86.

If the body in question is lighter than water it tends to rise to the surface, and will not remain on the lower pan C. To obviate this, a small moveable cage of fine wire is adjusted so as to prevent the ascent of the body. The experiment is in other respects the same.

122. **Specific gravity bottle.**—When the specific gravity of a substance in a state of powder is required, it can be found most conveniently by means of the specific gravity bottle. This instrument is a small bottle, with a large neck fitted with a carefully ground glass stopper (fig. 87). The stopper is perforated along its axis, and the bore is continued by means of a thin tube which expands into a tube of greater diameter, as shown in the figure. On the thin tube is a mark  $a$ , and at each weighing the bottle is filled with water exactly to the mark. This is done by filling the bottle when wholly under water, and putting in the stopper while it is immersed. The bottle and the tube are then completely filled, and the quantity of water in excess is removed by blotting paper. To find the specific gravity proceed as



Fig. 87.

follows : Having weighed the powder, place it in one of the scale pans and with it the bottle filled exactly to *a*, and carefully dried. Then balance it by placing small shot, or sand, in the other pan. Next, remove the bottle and pour the powder into it, and, as before, fill it up with water to the mark *a*. On replacing the bottle in the scale pan it will no longer balance the shot, since the powder has displaced a volume of water equal to its own volume. Place weights in the scale pan along with the bottle until they balance the shot. These weights give the weight of the water displaced. Then the weight of the powder, and the weight of an equal bulk of water being known, its specific gravity is determined as before.

It is important in this determination to remove the layer of air which adheres to the powder, and unduly increases the quantity of water expelled. This is effected by placing the bottle under the receiver of an air-pump and exhausting. The same result is obtained by boiling the water in which the powder is placed.

123. **Bodies soluble in water.**—If the body, whose specific gravity is to be determined by any of these methods, is soluble in water, the determination is made in some liquid in which it is not soluble, such as oil, turpentine, or naphtha, the specific gravity of which is known. The specific gravity is obtained by multiplying the number obtained in the experiment by the specific gravity of the liquid used for the determination.

Suppose, for example, a determination of the specific gravity of potassium has been made in naphtha. For equal volumes, *P* represents the weight of the potassium, *P'* that of the naphtha, and *P''* that of water ; consequently,  $\frac{P}{P'}$  will be the specific gravity of the substance in reference to naphtha, and  $\frac{P'}{P''}$  the specific gravity of the naphtha in reference to water. The product of these two fractions  $\frac{P}{P''}$  is the specific gravity of the substance compared with water.

In determining the specific gravity of porous substances, they are varnished before being immersed in water, which renders them impervious to moisture without altering their volume.

*Specific gravity of solids at zero as compared with distilled water at 4° C.*

Platinum, rolled . . . . .	22·069	Iron, cast . . . . .	7·207
„ cast . . . . .	20·337	Tin, cast . . . . .	7·291
Gold, stamped . . . . .	19·362	Zinc, cast . . . . .	6·861
„ cast . . . . .	19·258	Antimony, cast . . . . .	6·712
Lead, cast . . . . .	11·352	Diamonds . . . . .	3·531 to 3·501
Silver, cast . . . . .	10·474	Flint glass . . . . .	3·329
Bismuth, cast . . . . .	9·822	Statuary marble . . . . .	2·837
Copper, drawn wire . . . . .	8·878	Aluminium . . . . .	2·680
„ cast . . . . .	8·788	Rock crystal . . . . .	2·653
Brass . . . . .	8·383	St. Gobin glass . . . . .	2·488
Steel, not hammered . . . . .	7·816	China porcelain . . . . .	2·385
Iron, bar . . . . .	7·788	Sèvres porcelain . . . . .	2·146

## Specific gravity of solids at zero—continued.

Native sulphur . . . . .	2.033	Beech . . . . .	0.852
Ivory . . . . .	1.917	Oak . . . . .	0.845
Anthracite . . . . .	1.800	Elm . . . . .	0.800
Compact coal . . . . .	1.329	Yellow Pine . . . . .	0.657
Amber . . . . .	1.078	Litheim . . . . .	0.585
Melting ice . . . . .	0.930	Common poplar . . . . .	0.389
Potassium . . . . .	0.865	Cork . . . . .	0.240

## 124. Specific gravity of liquids.—i. Method of the hydrostatic balance.

From the pan of the hydrostatic balance a body is suspended, on which the liquid, whose specific gravity is to be determined, exerts no chemical action; for example, a ball of platinum. This is then successively weighed in air, in distilled water, and in the liquid. The loss of weight of the body in these two liquids is noted. They represent respectively the weights of equal volumes of water and of the given liquid, and consequently it is only necessary to divide the second of them by the first to obtain the required specific gravity.

Let  $P$  be the weight of the platinum ball in air,  $P'$  its weight in water,  $P''$  its weight in the given liquid, and let  $D$  be the specific gravity sought. The weight of the water displaced by the platinum is  $P - P'$  and that of the second liquid is  $P - P''$ , from which we get  $D = \frac{P - P''}{P - P'}$ .

ii. *Fahrenheit's hydrometer*.—This instrument (fig. 88) resembles Nicholson's hydrometer, but it is made of glass, so as to be used in all liquids. At its lower extremity, instead of a pan, it is loaded with a small bulb containing mercury. There is a standard mark on the stem.

The weight of the instrument is first accurately determined in air; it is then placed in water, and weights added to the scale pan until the mark on the stem is level with the water. It follows from the first principle of the equilibrium of floating bodies, that the weight of the hydrometer, together with the weight in the scale-pan, is equal to the weight of the volume of the displaced water. In the same manner, the weight of an equal volume of the given liquid is determined, and the specific gravity is found by dividing the latter weight by the former.

Neither Fahrenheit's nor Nicholson's hydrometers give such accurate results as the hydrostatic balance.

iii. *Specific gravity bottle*.—This has been already described (122). In determining the specific gravity of a liquid, a bottle of special construction is used; it consists of a cylindrical reservoir  $b$  (fig. 89), to which is fused a capillary tube  $c$ , and to this again a wider tube  $a$  closed with a stopper, the bottle is first weighed empty, and then successively, full of water to the mark  $c$  on the capillary stem, and of the given liquid. If the weight of the bottle be



Fig. 88.



Fig. 89.

subtracted from the two weights thus obtained, the result represents the weights of equal volumes of the liquid, and of water, from which the specific gravity is obtained by division.

**125. On the observation of temperature in ascertaining specific gravities.**—As the volume of a body increases with the temperature, and as this increase varies with different substances, the specific gravity of any given body is not exactly the same at different temperatures; and consequently, a certain fixed temperature is chosen for those determinations. That of water, for example, has been made at  $4^{\circ}$  C., for at this point it has the greatest density. The specific gravities of other bodies are assumed to be taken at zero; but as this is not always possible, certain corrections must be made, which we shall consider in the Book on Heat.

*Specific gravities of liquids at zero, compared with that of water at  $4^{\circ}$  C. as unity.*

Mercury . . . . .	13'598	Sea-water . . . . .	1'026
Bromine . . . . .	2'960	Distilled water at $4^{\circ}$ C. . . . .	1'000
Sulphuric acid . . . . .	1'841	"    "    at $0^{\circ}$ C. . . . .	0'999
Chloroform . . . . .	1'525	Claret . . . . .	0'994
Nitric acid . . . . .	1'420	Olive oil . . . . .	0'915
Bisulphide of carbon . . . . .	1'293	Oil of turpentine . . . . .	0'870
Hydrochloric acid . . . . .	1'240	Naphtha . . . . .	0'847
Blood . . . . .	1'060	Absolute alcohol . . . . .	0'803
Milk . . . . .	1'032	Ether . . . . .	0'723

**126. Use of tables of specific gravity.**—Tables of specific gravity admit of numerous applications. In mineralogy the specific gravity of a mineral is often a highly distinctive character. By means of tables of specific gravities the weight of a body may be calculated when its volume is known, and conversely the volume when its weight is known.

With a view to explaining the last-mentioned use of these tables, it will be well to premise a statement of the connection existing between the British units of length, capacity, and weight. It will manifestly be sufficient for this purpose to define that which exists between the yard, gallon, and pound avoirdupois, since other measures stand to these in well-known relations. The *yard*, consisting of 36 inches, may be regarded as the primary unit. Though it is essentially an arbitrary standard, it is determined by this, that the simple pendulum which makes one oscillation, in a mean second at London on the sea-level, is 39'1398 inches long. The *gallon* contains 277'274 cubic inches. A gallon of distilled water at the standard temperature weighs 10 pounds avoirdupois or 70,000 grains troy; or, which comes to the same thing, one cubic inch of water weighs 252'5 grains.

On the French system the *metre* is a primary unit, and is so chosen that 10,000,000 metres are the length of a quadrant of the meridian from either pole to the equator. The metre contains 10 *decimetres*, or 100 *centimetres*, or 1,000 *millimetres*, its length equals 1'0936 yards. The unit of the measure of capacity is the *litre* or cubic decimetre. The unit of weight is the *gramme*, which is the weight of a cubic centimetre of distilled water at  $4^{\circ}$  C. The *kilogramme* contains 1,000 grammes, or is the weight of a decimetre of distilled water at  $4^{\circ}$  C. The *gramme* equals 15'443 grains.

If  $V$  is the number of cubic centimetres (or decimetres) in a certain quantity of distilled water at  $4^{\circ}$  C., and  $P$  its weight in grammes (or kilogrammes), it is plain that  $P=V$ . Now consider a substance whose specific gravity is  $D$ , every cubic centimetre of this substance will weigh as much as  $D$  cubic centimetres of water, and therefore  $V$  centimetres of this substance will weigh as much as  $DV$  centimetres of water. Hence if  $P$  is the weight of the substance in grammes, we have  $P=DV$ . If, however,  $V$  is the volume in cubic inches, and  $P$  the weight in grains, we shall have  $P=252.5 DV$ .

As an example, we may calculate the internal diameter of a glass tube. Mercury is introduced, and the length and weight of the column at  $4^{\circ}$  C. are accurately determined. As the column is cylindrical, we have  $V=\pi r^2 l$ , where  $r$  is the radius, and  $l$  the length of the column in centimetres. Hence if  $D$  is the specific gravity of mercury, and  $P$  the weight of the column in grammes, we have  $P=\pi r^2 l D$ , and therefore

$$r = \sqrt{\frac{P}{\pi D l}}$$

If  $r$  and  $l$  are in inches and  $P$  in grains, we shall have  $P=252.5\pi r^2 l D$ , and therefore

$$r = \sqrt{\frac{P}{252.5\pi D l}}$$

In a similar manner the diameter of very fine metal wires can be calculated.

127. **Hydrometers with variable volume.**—The hydrometers of Nicholson and Fahrenheit are called *hydrometers of constant volume, but variable weight*, because they are always immersed to the same extent, but carry different weights. There are also *hydrometers of variable volume but of constant weight*. These instruments, known under the different names of *acidometer, alcoholometer, lactometer, and saccharometer*, are not used to determine the exact specific gravity of the liquids, but to show whether the acids, alcohols, milk, solutions of sugar, etc., under investigation, are more or less concentrated.

128. **Beaumé's hydrometer.**—This, which was the first of these instruments, may serve as a type of them. It consists of a glass tube (fig. 90) loaded at its lower end with mercury, and with a bulb blown in the middle. The stem, the external diameter of which is as regular as possible, is hollow, and the scale is marked upon it.

The graduation of the instrument differs according as the liquid, for which it is to be used, is heavier or lighter than water. In the first case, it is so constructed that it sinks in water nearly to the top of the stem, to a point  $A$ , which is marked zero. A solution of fifteen parts of salt in eighty-five parts of water is made, and the instruments immersed in it. It sinks to a certain point on the stem,  $B$ , which is marked 15; the distance between  $A$  and  $B$  is divided into 15 equal



Fig. 90.

parts, and the graduation continued to the bottom of the stem. Sometimes the graduation is on a piece of paper in the interior of the stem.

The hydrometer thus graduated only serves for liquids of a greater specific gravity than water, such as acids and saline solutions. For liquids lighter than water a different plan must be adopted. Beaumé took for zero the point to which the apparatus sank in a solution of 10 parts of salt in 90 of water, and for  $10^{\circ}$  he took the level in distilled water. This distance he divided into  $10^{\circ}$ , and continued the division to the top of the scale.

The graduation of these hydrometers is entirely conventional, and they give neither the densities of the liquids, nor the quantities dissolved. But they are very useful in making mixtures or solutions in given proportions, the results they give being sufficiently near in the majority of cases. For instance, it is found that a well-made syrup marks 35 on Beaumé's hydrometer, from which a manufacturer can readily judge whether a syrup which is being evaporated has reached the proper degree of concentration.

129. **Gay-Lussac's alcoholometer.**—This instrument is used to determine the strength of spirituous liquors; that is, the proportion of pure alcohol which they contain. It differs from Beaumé's hydrometer in the graduation.

Mixtures of absolute alcohol and distilled water are made containing 5, 10, 20, 30, etc., per cent. of the former. The alcoholometer is so constructed that, when placed in pure distilled water, the bottom of its stem is level with the water, and this point is zero. It is next placed in absolute alcohol, which marks  $100^{\circ}$ , and then successively in mixtures of different strengths, containing 10, 20, 30, etc., per cent. The divisions thus obtained are not exactly equal, but their difference is not great, and they are subdivided into ten divisions, each of which marks *one* per cent. of absolute alcohol in a liquid. Thus a brandy in which the alcoholometer stood at  $48^{\circ}$  would contain 48 per cent. of absolute alcohol, and the rest would be water.

All these determinations are made at  $15^{\circ}$  C., and for that temperature only are the indications correct. For, other things being the same, if the temperature rises, the liquid expands, and the alcoholometer will sink, and the contrary if the temperature fall. To obviate this error, Gay-Lussac constructed a table which for each percentage of alcohol gives the reading of the instrument for each degree of temperature from  $0^{\circ}$  up to  $30^{\circ}$ . When the exact analysis of an alcoholic mixture is to be made, the temperature of the liquid is first determined, and then the point to which the alcoholometer sinks in it. The number in the table corresponding to these data indicates the percentage of alcohol. From its giving the percentage of alcohol, this is often called the *centesimal alcoholometer*.

130. **Salimeters.**—*Salimeters*, or instruments for indicating the percentage of salt contained in a solution, are made on the principle of the centesimal alcoholometer. They are graduated by immersing them in pure water which gives the zero, and then in solutions containing different percentages, 5, 10, 20, etc., of the salt, and marking on the scale the corresponding points. These instruments are so far objectionable that every salt requires a special instrument. Thus one graduated for common salt would give totally false indications in a solution of nitre.

*Lactometers* and *vinometers* are similar instruments and are used for

measuring the quantity of water which is introduced into milk or wine for the purpose of adulteration. But their use is limited, because the density of these liquids is very variable, even when they are perfectly natural, and an apparent fraud may be really due to a bad natural quality of wine or of milk. *Urinometers*, which are of extensive use in medicine, are based on the same principle.

131. **Densimeter.**—The *densimeter* is an apparatus for indicating the specific gravity of a liquid. Gay-Lussac's densimeter has the same construction as Beaumé's hydrometer, but is graduated in a different manner. Rousseau's densimeter (fig. 91) is of great use in many scientific investigations, in determining the specific gravity of a small quantity of a liquid. It has the same form as Beaumé's hydrometer, but on the upper part of the stem there is a small tube AC, in which is placed the substance to be determined. A mark A on the side of the tube indicates a measure of a cubic centimetre.

The instrument is so constructed that when AC is empty it sinks in distilled water to a point, B, just at the bottom of the stem. It is then filled with distilled water to the height measured on the tube AC, which indicates a cubic centimetre, and the point to which it now sinks is  $20^{\circ}$ . The interval between 0 and 20 is divided into 20 equal parts, and this graduation is continued to the top of the scale. As this is of uniform bore each division corresponds to  $\frac{1}{20}$  gramme or 0.05.

To obtain the density of any liquid, bile for example, the tube is filled with it up to the mark A; if the densimeter sinks to  $20\frac{1}{2}$  divisions, its weight is  $0.05 \times 20.5 = 1.025$ ; that is to say, that with equal volumes, the weight of water being 1, that of bile is 1.025. The specific gravity of bile is therefore 1.025.



Fig. 91.

## CHAPTER II.

### CAPILLARITY, ENDOSMOSE, EFFUSION, ABSORPTION, AND IMBIBITION.

132. **Capillary phenomena.**—When solid bodies are placed in contact with liquids, a class of phenomena is produced called *capillary phenomena*, because they are best seen in tubes whose diameters are comparable with the diameter of a hair. These phenomena are treated of in physics under the head of *capillarity* or *capillary attraction*; the latter expression is also applied to the force which produces the phenomena.

The phenomena of capillarity are very various, but may all be referred to the mutual attraction of the liquid molecules for each other, and to the attraction between these molecules and solid bodies. The following are some of these phenomena :—

When a body is placed in a liquid which wets it—for example, a glass rod in water—the liquid, as if not subject to the laws of gravitation, is raised upwards against the sides of the solid, and its surface, instead of being hori-



zontal, becomes slightly concave (fig. 92). If, on the contrary, the solid is one which is not moistened by the liquid, as glass by mercury, the liquid is depressed against the sides of the solid, and assumes a convex shape, as represented in fig. 93. The surface of the liquid exhibits the same concavity or convexity against the sides of a vessel in which it is contained, according as the sides are or are not moistened by the liquid.

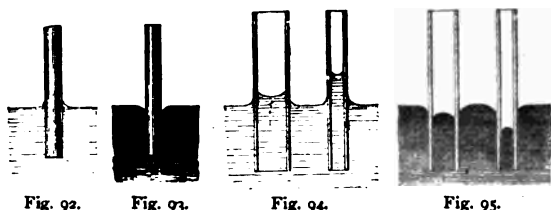

Fig. 92.

Fig. 93.

Fig. 94.

Fig. 95.

These phenomena are much more apparent when a tube of small diameter is placed in a liquid. And according as the tubes are or are not moistened by the liquid, an ascent or a depression of the liquid is produced which is greater in proportion as the diameter is less (figs. 94 and 95).

When the tubes are moistened by the liquid, its surface assumes the form of a concave hemispherical segment, called the *concave meniscus* (fig. 94); when the tubes are not moistened, there is a *convex meniscus* (fig. 95).

**133. Laws of the ascent and depression in capillary tubes.**—The most important law in reference to capillarity is known as *Jurin's law*. It is that the height of the ascent of one and the same liquid in a capillary tube is inversely as the diameter of the tube. Thus, if water rise to a height of 30 mm. in a tube 1 mm. in diameter, it will only rise to a height of 15 mm. in a tube 2 mm. in diameter, but to a height of 300 mm. in a tube 0·1 mm. in diameter. This law has been verified with tubes whose diameters ranged from 5 mm. 0·07 mm. It presupposes that the liquid has previously moistened the tube.

The height to which a liquid rises in a tube, diminishes as the temperature rises. Thus in a capillary tube in which water stood at a height of 30·7 mm. at 0°, it stood at 28·6 mm. at 35°, and at 26 mm. at 80°.

Provided the liquid moistens the tube, neither its thickness nor its nature has any influence on the height to which the liquid rises. Thus water rises to the same height in tubes of different kinds of glass, and of rock crystal, provided the diameters are the same.

The nature of the liquid is of great importance; of all liquids water rises the highest; thus in a glass tube 1·29 mm. in diameter, the heights of water, alcohol, and turpentine were respectively 23·16, 9·18, and 9·85 millimetres.

In regard to the depression of liquids in tubes which they do not moisten, Jurin's law has not been found to hold with the same accuracy. The reason for this is probably to be found in the following circumstances. When a liquid moistens a capillary tube, a very thin layer of liquid is formed against the sides, and remains adherent even when the liquid sinks in the tube. The ascent of the column of liquid takes place then, as it were, inside a central tube, with which it is physically and chemically identical. The

ascent of the tube is thus an act of cohesion. It is therefore easy to understand why the nature of the sides of the capillary tube should be without influence on the height of the ascent, which only depends on the diameter.

With liquids, on the contrary, which do not moisten the sides of the tube the capillary action takes place between the sides and the liquid. The nature and structure of the sides are never quite homogeneous, and there is always, moreover, a layer of air on the inside, which is not dissolved by the liquid. These two causes exert undoubtedly a disturbing influence on the law of Jurin.

**134. Ascent and depression between parallel or inclined surfaces.—**

When two bodies of any given shape are dipped in water, analogous capillary phenomena are produced, provided the bodies are sufficiently near. If, for example, two parallel glass plates are immersed in water at a very small distance from each other, water will rise between the two plates in the inverse ratio of the distance which separates them. The height of the ascent for any given distance is half what it would be in a tube whose diameter is equal to the distance between the plates.

If the parallel plates are immersed in mercury, a corresponding depression is produced, subject to the same laws.

If two glass plates AB and AC with their planes vertical and inclined to one another at a small angle, as represented in fig. 96, have their ends

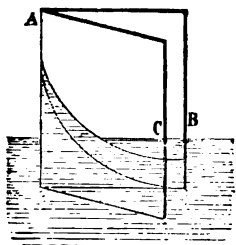

Fig. 96.



Fig. 97.



Fig. 98.

dipped into a liquid which wets them, the liquid will rise between them. The elevation will be greatest at the line of contact of the plates and from thence gradually less, the surface taking the form of an equilateral hyperbola, whose asymptotes are respectively the line of intersection of the plates, and the line in which the plates cut the horizontal surface of the liquid.

If a drop of water be placed within a conical glass tube whose angle is small and axis horizontal, it will have a concave meniscus at each end (fig. 97), and will tend to move towards the vertex. But if the drop be of mercury it will have a convex meniscus at each end (fig. 98) and will tend to move from the vertex.

**135. Attraction and repulsion produced by capillarity.—**The attractions and repulsions observed between bodies floating on the surface of liquids are due to capillarity, and are subject to the following laws :—

i. When two floating balls both moistened by the liquid, for example, cork upon water, are so near that the liquid surface between them is not level, an attraction takes place.

ii. The same effect is produced when neither of the balls is moistened, as is the case with balls of wax on water.

iii. Lastly, if one of the balls is moistened and the other not, as a ball of cork and a ball of wax in water, they repel each other if the curved surfaces of the liquid in their respective neighbourhoods intersect.

As all these capillary phenomena depend on the concave or convex curvature which the liquid assumes in contact with the solid, a short explanation of the cause which determines the form of this curvature is necessary.

136. **Cause of the curvature of liquid surfaces in contact with solids.**—The form of the surface of a liquid in contact with a solid depends on the relation between the attraction of the solid for the liquid, and of the mutual attraction between the molecules of the liquid.

Let  $m$  be a liquid molecule (fig. 99) in contact with a solid. This molecule is acted upon by three forces: by gravity, which attracts it in the direction of the vertical  $mP$ ; by the attraction of the liquid  $F$ , which acts in the direction  $mF$ ; and by the attraction of the plate  $n$ , which is exerted in the direction  $mn$ . According to the relative intensities of these forces, their resultant can take three positions:—

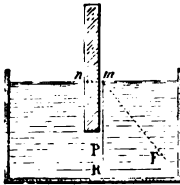

Fig. 99.

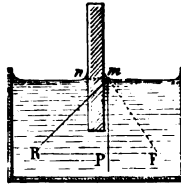

Fig. 100.

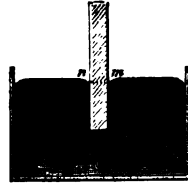

Fig. 101.

i. The resultant is in the direction of the vertical  $mR$  (fig. 99). In this case the surface  $m$  is plane and horizontal; for, from the condition of the equilibrium of liquids, the surface must be perpendicular to the force which acts upon the molecules.

ii. If the force  $n$  increases or  $F$  diminishes, the resultant  $R$  is within the angle  $nmP$  (fig. 100); in this case the surface takes a direction perpendicular to  $mR$ , and becomes concave.

iii. If the force  $F$  increases, or  $n$  diminishes, the resultant  $R$  takes the direction  $mR$  (fig. 101) within the angle  $PmF$ , and the surface, becoming perpendicular to this direction, is convex.

137. **Influence of the curvature on capillary phenomena.**—The elevation or depression of a liquid in a capillary tube depends on the concavity or convexity of the meniscus. In a concave meniscus,  $abcd$  (fig. 102), the liquid molecules are sustained in equilibrium by the forces acting on them, and they exercise no downward pressure on the inferior layers. On the contrary, in virtue of the molecular attraction, they act on the nearest inferior layers, from which it follows that the pressure on any layer,  $mn$ , in the interior of the tube, is less than if there were no meniscus. The consequence is, that the liquid ought to rise in the tube until the internal pressure on the layer  $mn$  is equal to the pressure,  $op$ , which acts externally on a point,  $p$ , of the same layer.

Where the meniscus is convex (fig. 103) equilibrium exists in virtue of the molecular forces acting on the liquid; but as the molecules which would occupy the same space *ghik*, if there were no molecular action, do not exist, they exercise no attraction on the lower layers. Consequently, the pressure

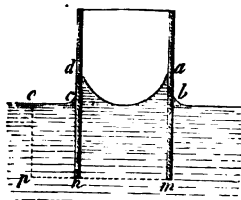

Fig. 102.

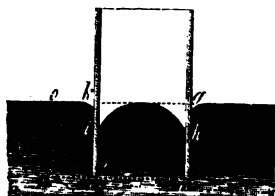

Fig. 103.

on any layer *mn*, in the interior of the tube, is greater than if the space *ghik* were filled, for the molecular forces are more powerful than gravity. The liquid ought therefore to sink in the tube until the internal pressure on a layer *mn*, is equal to the external pressure on any point, *p*, of this layer.

138. **Tension of the free surface of liquids.**—The surface of a liquid has greater cohesion than any layer of the liquid in the interior. For consider any particle at the surface, it will be attracted by the adjacent particles in all directions except in that above the surface. The attractions acting laterally will compensate each other, and as there are no attractions above the surface to counteract those acting from the interior, the latter will exercise a considerable pull towards the interior. The effect of this is to lessen the mobility of particles on the surface, while those in the interior are quite mobile; the surface, as it were, is stretched by an elastic skin. This *surface tension*, as it may be called, is greater, the greater the cohesion of the liquid; it is well illustrated by blowing a soap-bubble on a glass tube; so long as the other end of the tube is closed, the bubble remains, the elastic force of the enclosed air counterbalancing the tension of the surface; but when the tube is opened, the latter being unchecked, the bubble gradually contracts and finally disappears.

139. **Various capillary phenomena.**—The following facts are among the many which are caused by capillarity:—

When a capillary tube is immersed in a liquid which moistens it, and is then carefully removed, the column of liquid in the tube is seen to be longer than while the tube was immersed in the liquid. This arises from the fact that a drop adheres to the lower extremity of the tube and forms a concave meniscus, which concurs with that of the upper meniscus to form a longer column (132).

For the same reason a liquid does not overflow in a capillary tube, although the latter may be shorter than the liquid column which would otherwise be formed in it. For when the liquid reaches the top of the tube, its upper surface, though previously concave, becomes convex, and as the downward pressure becomes greater than if the surface were plane, the ascending motion ceases.

A drop of mercury on a table has a spherical shape, which, like that of the heavenly bodies, is due to attraction. The globule of mercury behaves

as if its molecules had no weight, since it remains spherical. That is, the molecular attraction is far greater than the weight, which only alters the shape of the globule if the quantity of mercury is much greater; it then flattens but always retains at its edge the convex form which attraction imparts to it.

Insects can often move on the surface of water, without sinking. This is a capillary phenomenon caused by the fact that, as their feet are not wetted by the water, a depression is produced which keeps them up in spite of their weight. Similarly a sewing needle, gently placed on water, does not sink, because its surface, being covered with an oily layer, does not become wetted. But if washed in alcohol or in potash, it at once sinks to the bottom.

It is from capillarity that oil ascends in the wicks of lamps, that water rises in wood, sponge, bibulous paper, sugar, sand, and in all bodies which possess pores of a perceptible size. In the cells of plants the sap rises with great force, for here we have to do with vessels whose diameter is less than 0.01 mm. Efflorescence of salts is also due to capillarity; a solution rising against the side of a vessel, the water evaporates, and the salt forms on the side a means of furthering still more the ascent of the liquid. Capillarity is, moreover, the cause of the following phenomenon:—When a porous substance, such as gypsum, or chalk, or even earth, is placed in a porous vessel of unbaked porcelain, and the whole is dipped in water, the water penetrates into the pores, and the air is driven inwards, so that it is under four or five times its usual pressure and density.

Jamin has proved this by cementing a manometer into blocks of chalk, gypsum etc., and he has made it probable that a pressure of this kind, exerted upon the roots, promotes the ascent of sap in plants.

#### ENDOSMOSE, EFFUSION, ABSORPTION, AND IMBIBITION.

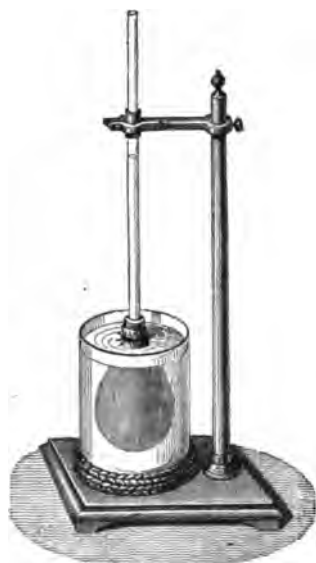

Fig. 104.

140. **Endosmose and exosmose.**—When two different liquids are separated by a thin porous partition, either inorganic or organic, a current sets in from each liquid to the other; to these currents the names *endosmose* and *exosmose* are respectively given. These terms, which signify *impulse from within* and *impulse from without*, were originally introduced by M. Dutrochet, who first drew attention to these phenomena. They may be well illustrated by means of the *endosmometer*. This consists of a long tube, at the end of which a membranous bag is firmly bound (fig. 104). The bag is then filled with a strong syrup, or other solution denser than water, such as milk or albumen, and is held in water. The liquid is found gradually to rise in the tube, to a

bag is firmly bound (fig. 104).

The bag is then filled with a strong syrup, or other solution denser than water, such as milk or albumen, and is held in water. The liquid is found gradually to rise in the tube, to a

height which may attain several inches : at the same time, the level of the liquid in which the endosmometer is immersed becomes lower. It follows therefore, that some of the external liquid has passed through the membrane and has mixed with the internal liquid. The external liquid, moreover, is found to contain some of the internal liquid. Hence two currents have been produced in opposite directions. The flow of the liquid towards that which increases in volume is *endosmose*, and the current in the opposite direction is *exosmose*. If water is placed in the bag, and immersed in the syrup, endosmose is produced from the water towards the syrup, and the liquid in the interior diminishes in volume while the level of the exterior is raised.

The height of the ascent in the endosmometer varies with different liquids. Of all vegetable substances, sugar is that which, for the same density has the greatest power of endosmose, while albumen has the highest power of all animal substances. In general it may be said that endosmose takes place towards the denser liquid. Alcohol and ether form an exception to this ; they behave like liquids which are denser than water. With acids, according as they are more or less dilute, the endosmose is from the water towards the acid, or from the acid towards the water.

According to Dutrochet, it is necessary for the production of endosmose : i. that the liquids be different but capable of mixing, as alcohol and water—there is no endosmose, for instance, with water and oil ; ii. that the liquids be of different densities ; and iii. that the membrane must be permeable to at least one of the substances.

The current through thin inorganic plates is feeble, but continuous, while organic membranes are rapidly decomposed, and endosmose then ceases.

The well-known fact that dilute alcohol kept in a porous vessel becomes concentrated depends on endosmose. If a mixture of alcohol and water be kept for some time in a bladder, the volume diminishes, but it becomes much more concentrated. The reason, doubtless, is that the bladder permits the endosmose of water rather than that of alcohol.

Dutrochet's method is not adapted for quantitative measurements, for it does not take into account the hydrostatic pressure produced by the column. Jolly has examined the endosmose of various liquids by determining the weights of the bodies diffused. He calls the *endosmotic equivalent* of a substance the number which expresses how many parts by weight of water pass through the bladder in exchange for one part by weight of the substance. The following are some of the endosmotic equivalents which he determined :—

Chloride of sodium . . . .	4 3	Caustic potass . . . .	215 0
Sulphate of magnesium . . . .	11 7	Sulphuric acid . . . .	0 4
"    copper . . . .	9 5	Alcohol . . . .	4 2
Sugar . . . .	7 1		

He also found that the endosmotic equivalent increases with the temperature and that the quantities of substances which pass in equal times through the bladder are proportional to the strengths of the solutions.

141. **Diffusion of liquids.**—If oil be poured on water no tendency to intermix is observed, and even if the two liquids be violently agitated together, on allowing them to stand, two separate layers are formed. With alcohol and water the case is different; if alcohol, which is specifically lighter, be poured upon water, the liquids gradually intermix. spite of the difference of their specific gravities; they *diffuse* into one another.

This point may be illustrated by the experiment represented in fig. 106. A tall jar contains water coloured by solution of blue litmus; by means of a funnel some dilute sulphuric acid is carefully poured in, so as to form a layer at the bottom; the colour of the solution is changed into red, progressing upwards, and after forty-eight hours the change is complete—a result of the action of the acid, and a proof, therefore, that it has diffused throughout the entire mass.

The laws of this diffusion, in which no porous diaphragm intervenes, have been completely investigated by Graham. The method, by which his latest experiments were made, was the following :—A small wide-necked bottle A

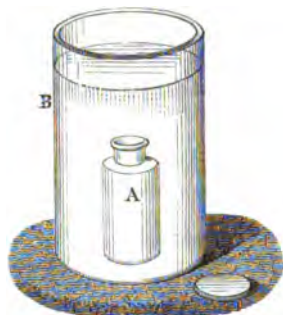

Fig. 105.



Fig. 106.

(fig. 105) filled with the liquid, whose rate of diffusion was to be examined, was closed by a thin glass disc and placed in a larger vessel B, in which water was poured to a height of about an inch above the top of the bottle. The disc was carefully removed, and then after a given time successive layers were carefully drawn off by means of a syphon or pipette, and their contents examined.

The general results of these investigations may be thus stated :—

i. When solutions of the same substance, but of different strengths, are taken, the quantities diffused in equal times are proportional to the strengths of the solutions.

ii. In the case of solutions containing equal weights of different substances, the quantities diffused vary with the nature of the substances. Saline substances may be divided into a number of *equidiffusive groups*, the rates of diffusion of each group being connected with the others by a simple numerical relation.

iii. The quantity diffused varies with the temperature. Thus, taking the rate of diffusion of hydrochloric acid at  $15^{\circ}$  C. as unity, at  $49^{\circ}$  C. it is 2.18.

iv. If two substances which do not combine be mixed in solution, they may be partially separated by diffusion, the more diffusive one passing out most rapidly. In some cases chemical decomposition even may be effected by diffusion. Thus, bisulphate of potassium is decomposed into free sulphuric acid and neutral sulphate of potassium.

v. If liquids be dilute a substance will diffuse into water, containing another substance dissolved, as into pure water; but the rate is materially reduced if a portion of the same diffusing substance be already present.

The following table gives the approximate times of equal diffusion :—

Hydrochloric acid . . . . .	1'0	Sulphate of magnesium . . . . .	7'0
Chloride of sodium . . . . .	2'3	Albumen . . . . .	49'0
Sugar . . . . .	7'0	Caramel . . . . .	98'0

It will be seen from the above table that the difference between the rates of diffusion is very great. Thus, sulphate of magnesium, one of the least diffusible saline substances, diffuses 7 times as rapidly as albumen and 14 times as rapidly as caramel. These last substances, like hydrated silicic acid, starch, dextrine, gum, etc., constitute a class of substances which are characterised by their incapacity for taking the crystalline form and by the mucilaginous character of their hydrates. Considering gelatine as the type of this class, Graham has proposed to call them *colloids* (κόλλη, glue), in contradistinction to the far more easily diffusible *crystalloid* substances.

Graham has proposed a method of separating bodies based on their unequal diffusibility, which he calls *dialysis*. His *dialyser* (fig. 107) consists of



Fig. 107.

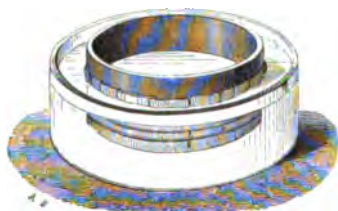

Fig. 108.

a ring of gutta percha, over which is stretched while wet a sheet of parchment paper, forming thus a vessel about two inches high and ten inches in diameter, the bottom of which is of parchment paper. After pouring in the mixed solution to be dialysed, the whole is floated on a vessel containing a very large quantity of water (fig. 108). In the course of one or two days a more or less complete separation will have been effected. Thus a solution of arsenious acid mixed with various kinds of food readily diffuses out.

The process has received important applications to laboratory and pharmaceutical purposes.

For further information on this subject the student is referred to a very complete article on the diffusion of liquids in the third volume of Watt's 'Dictionary of Chemistry.'



142. **Endosmose of gases.**—The phenomena of endosmose are seen in a high degree in the case of gases. When two different gases are separated by a porous diaphragm, an exchange takes place between them, and ultimately the composition of the gas on both sides of the diaphragm is the same; but the rapidity with which different gases diffuse into each other under these circumstances varies considerably. The laws regulating this phenomenon have been investigated by Graham. Numerous experiments illustrate it, two of the most interesting of which are the following.

A glass cylinder closed at one end is filled with carbonic acid gas, its open end tied over with a bladder, and the whole placed under a jar of hydrogen. Diffusion takes place between them through the porous diaphragm, and after the lapse of a certain time hydrogen has passed through the bladder into the cylindrical vessel in much greater quantity than the carbonic acid which has passed out, so that the bladder becomes very much distended outwards (fig. 109). If the cylinder be filled with hydrogen and



Fig. 109.

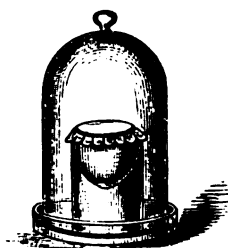

Fig. 110.

the bell-jar with carbonic acid, the reverse phenomenon will be produced—the bladder will be distended inwards (fig. 110).

A tube about 12 inches long, closed at one end by a plug of dry plaster of Paris, is filled with dry hydrogen, and its open end then immersed in a mercury bath. Endosmose of the hydrogen towards the air takes place so rapidly that a partial vacuum is produced, and mercury rises in the tube to a height of several inches (fig. 111). If several such tubes are filled with different gases, and allowed to diffuse into the air in a similar manner, in the same time, different quantities of the various gases will diffuse, and Graham found that the law regulating these diffusions is, that *the force of diffusion is inversely as the square roots of the densities of gases*. Thus, if two vessels of equal capacity, containing oxygen and hydrogen, be separated by a porous plug, diffusion takes place; and after the lapse of some time, for every one part of oxygen which has passed into the hydrogen, four parts of hydrogen have passed into the oxygen. Now the density of



Fig. 111.

hydrogen being 1, that of oxygen is 16, hence the force of diffusion is inversely as the square roots of these numbers. It is four times as great in the one which has  $\frac{1}{16}$ th the density of the other.

**143. Effusion and Transpiration of Gases.**—A gas can only flow from one space to another space occupied by the same gas when the pressure in the one is greater than in the other. *Effusion* is the term applied to the phenomenon of the passage of gases into vacuum, through a minute aperture not much more or less than 0.013 millimetre in diameter, in a thin plate of metal or of glass. The velocity of the efflux is measured by the formula  $v = \sqrt{2gh}$ , in which  $h$  represents the pressure under which the gas flows, expressed in terms of the height of a column of the gas, which would exert the same pressure as that of the effluent gas. Thus for air under the ordinary pressure flowing into a vacuum, the pressure is equivalent to a column of mercury 76 centimetres high; and as mercury is approximately 10,500 times as dense as air, the equivalent column of air will be 76 centimetres  $\times$  10,500 = 7,980 metres. Hence the velocity of efflux of air into vacuum is  $= \sqrt{2 \times 9.8 \times 7,980} = 395.5$  metres. This velocity into vacuum only holds, however, for the first moment, for the space contains a continually-increasing quantity of air, so that the velocity becomes continually smaller, and is null when the pressure on each side is the same. If the height of the column of air  $h$ , corresponding to the external pressure, is known, the velocity may be calculated by the formula  $v = \sqrt{2g(h - h_1)}$ .

A difference of pressure between two adjacent columns of air equal to half an inch of mercury would produce a velocity of 68 feet, which is as great as that of a violent storm.

For gases lighter than air a greater height must be inserted in the formula, and for heavier gases a lower height; and this change must be inversely as the change of density. Hence *the velocities of efflux of various gases must be inversely as the square roots of their densities*. A simple inversion of this statement is that the *densities of two gases* are inversely as the squares of *their velocities of effusion*. On this Bunsen has based an interesting method of determining the densities of gases and vapours.

If gases issue through long, fine capillary tubes into a vacuum, the rate of efflux, or the *velocity of transpiration*, is independent of the rate of diffusion.

i. *For the same gas, the rate of transpiration increases, other things being equal, directly as the pressure*; that is, equal volumes of air of different densities require times inversely proportional to their densities.

ii. *With tubes of equal diameters, the volume transpired in equal times is inversely as the length of the tube.*

iii. *As the temperature rises the transpiration becomes slower.*

iv. *The rate of transpiration is independent of the material of the tube.*

**144. Absorption and Imbibition.**—The words absorption and imbibition are used almost promiscuously in physics; they indicate the penetration of a liquid or gas into a porous body. Absorption is used both for liquids and gases, while imbibition is restricted to liquids.

In physiology an important distinction is made between the two words; absorption means the penetration of a foreign substance into the tissues of a living body, while imbibition refers to penetration into bodies deprived of life, whether organic or not.

**145. Absorption of gases.**—The surfaces of all solid bodies exert an attraction on the molecules of gases with which they are in contact, of such

a nature that they become covered with a more or less thick layer of *condensed gas*. When a porous body such as a piece of charcoal, which consequently presents an immensely increased surface in proportion to its size, is placed in a vessel of ammonia gas over mercury (fig. 112), the great diminution of volume which ensues indicates that considerable quantities of gas are absorbed.

Now, although there is no absorption such as arises from chemical combinations between the solid and the gas (as with phosphorus and oxygen), still the quantity of gas absorbed is not entirely dependent on the physical conditions of the solid body; it is influenced in some measure by the chemical nature both of the solid and the gas. Box-wood charcoal has very great absorptive power. One volume of this substance at the ordinary temperature and pressure absorbs the following quantities of gas:—



Fig. 112.

Ammonia . . . . .	. 90 vol.
Hydrochloric acid . . . . .	. 85 „
Sulphurous „ . . . . .	. 65 „
Sulphuretted hydrogen . . . . .	. 55 „
Carbonic acid . . . . .	. 35 „
Carbonic oxide . . . . .	. 9.4 „
Oxygen . . . . .	. 9.2 „
Nitrogen . . . . .	. 7.5 „
Hydrogen . . . . .	. 1.75 „

The absorption of gases is in general greatest in the case of those which are most easily liquefied.

Cocoanut charcoal is even more highly absorbent; it absorbs 171 of ammonia, 73 of carbonic acid, and 108 of cyanogen at the ordinary pressure: the amount of absorption increases with the pressure.

The absorptive power of pine charcoal is about half as much as that of boxwood. The charcoal made from corkwood, which is very porous, is not absorbent; neither is graphite. Platinum, in the finely divided form known as platinum sponge, is said to absorb 250 times its volume of oxygen gas. Many other porous substances, such as meerschaum, gypsum, silk, etc., are also highly absorbent.

Graham found that at a high temperature platinum and iron allow hydrogen to traverse them even more readily than does caoutchouc in the cold. Thus while a square metre of caoutchouc 0.014 millimetres in thickness allowed 129 cubic centimetres of hydrogen at 20° to traverse it in a minute, a platinum tube 1.1 millimetres in thickness and of the same surface allowed 489 cubic centimetres to traverse it at a bright red heat.

This is probably connected with the property which some metals, though destitute of physical pores, possess of absorbing gases either on their surface or in their mass; and to which Graham has applied the term *occlusion*. It is best observed by allowing the heated metal to cool in contact with the gas. The gas cannot then be extracted by the air pump, but is disengaged on heating. In this way Graham found that platinum occluded four times its volume of hydrogen; iron wire 0.44 times its volume of hydrogen, and

4.15 volumes of carbonic oxide; silver reduced from the oxide, absorbed about seven volumes of oxygen, and nearly one volume of hydrogen when heated to dull redness in these gases. This property is most remarkable in palladium, which absorbs hydrogen, not only in cooling after being heated, but also in the cold. When, for instance, a palladium electrode is used in the decomposition of water, one volume of the metal can absorb 980 times its volume of the gas. This gas is again driven out on being heated, in which respect there is a resemblance to the solution of gases in liquids. By the occlusion of hydrogen the volume of palladium is increased by 0.09827 of its original amount, from which it follows that the hydrogen which under ordinary circumstances has a density 0.000089546 that of water has here a density nearly 9,868 times as great, or about 0.88 that of water. Hence the hydrogen must be in the liquid or even solid state; it probably forms thus an alloy with palladium, like a true metal, a view of this gas which is strongly supported by independent chemical considerations. The physical properties, in so far as they have been examined, support this view of its being an alloy.

## BOOK IV.

## ON GASES.

## CHAPTER I.

## PROPERTIES OF GASES. ATMOSPHERE. BAROMETERS.

146. **Physical properties of gases.**—Gases are bodies whose molecules are in a constant state of repulsion, in virtue of which they possess the most perfect mobility and are continually tending to occupy a greater space. This property of gases is known by the names *expansibility*, *tension*, or *elastic force*, from which they are often called *elastic fluids*.

Gases and liquids have several properties in common, and some in which they seem to differ are in reality only different degrees of the same property. Thus, in both, the particles are capable of moving : in gases quite freely ; in liquids not quite freely owing to a certain degree of viscosity. Both are compressible, though in very different degrees : if a liquid and a gas both exist under the pressure of one atmosphere, and then the pressure be doubled, the water is compressed by about the  $\frac{1}{30000}$ th part, while the gas is compressed by one-half. In density there is a great difference ; water, which is the type of liquids, is 770 times as heavy as air, the type of gaseous bodies, while under the pressure of one atmosphere. The property by which gases are distinguished from liquids is their tendency to indefinite expansion.

Matter assumes the solid, liquid, or gaseous form according to the relative strength of the cohesive and repulsive forces exerted between their particles. In liquids these forces balance ; in gases repulsion preponderates.

By the aid of pressure and of very low temperatures, the force of cohesion may be so far increased in many gases that they are converted into liquids, and there is every reason for believing that with sufficient pressure and cold they might all be liquefied. On the other hand, heat, which increases the force of repulsion, converts liquids, such as water, alcohol, and ether, into the æriform state in which they obey all the laws of gases. This æriform state of liquids is known by the name of *vapour*, while gases are bodies which, under ordinary temperature and pressure, remain in the æriform state.

In describing the properties of gases we shall, for obvious reasons, have exclusive reference to atmospheric air as their type.

147. **Expansibility of gases.**—This property of gases, their tendency to assume continually a greater volume, is exhibited by means of the following ex-

periment. A bladder closed by a stopcock and about half-full of air is placed under the receiver of the air-pump (fig. 113), and a vacuum is produced, on which the bladder immediately distends. This arises from the fact that the molecules of air repel each other and press against the sides of the bladder. Under ordinary conditions, this internal pressure is counter-balanced by the air in the receiver, which exerts an equal and contrary pressure. But when this pressure is removed by exhausting the receiver, the internal pressure becomes evident. When air is admitted into the receiver, the bladder resumes its original form.



Fig. 113.

148. **Compressibility of gases.**—The compressibility of gases is readily shown by the *pneumatic syringe* (fig. 114). This consists of a stout glass tube closed at one end and provided with a tight-fitting solid piston. When the rod of the piston is pressed, it moves down in the tube, and the air becomes compressed into a smaller volume; but as soon as the force is removed the air regains its original volume, and the piston rises to its former position.



Fig. 114.

149. **Weight of gases.**—From their extreme fluidity and expansibility, gases seem to be uninfluenced by the force of gravity: they nevertheless possess weight like solids and liquids. To show this, a glass globe of 3 or 4 quarts capacity is taken (fig. 115), the neck of which is provided with a stopcock, which hermetically closes it and by which it can be screwed to the plate of the air-pump. The globe is then exhausted, and its weight determined by means of a delicate balance. Air is now allowed to enter, and the globe again weighed. The weight in the second case will be found to be greater than before, and if the capacity of the vessel is known, the increase will obviously be the weight of that volume of air.

By a modification of this method, and with the adoption of certain precautions, the weight of air and of other gases has been determined. Perhaps the most accurate are those of Regnault, who found that a litre of dry air at  $0^{\circ}$  C., and under a pressure of 760 millimetres, weighs 1.293187 grammes.

Since a litre of water (or 1,000 cubic centimetres) at  $0^{\circ}$  weighs 0.999877 grammes, the density of air is 0.00129334 that of water under the same circumstances; that is, water is 773 times as heavy as air. Expressed in English measures, 100 cubic inches of dry air under the ordinary atmospheric pressure of 30 in. and at the temperature of  $16^{\circ}$  C. weigh 31 grains; the same volume of carbonic acid gas under the same circumstances weighs 47.25 grains; 100 cubic inches of hydrogen the lightest of all gases, weigh 2.14 grains; and 100 cubic inches of hydriodic acid gas weigh 146 grains.



Fig. 115.

**150. Pressures exerted by gases.**—Gases exert on their own molecules and on the sides of vessels which contain them, pressures which may be regarded from two points of view: First, we may neglect the weight of the gas; secondly, we may take account of its weight. If we neglect the weight of any gaseous mass at rest, and only consider its expansive force, it will be seen that the pressures due to this force act with the same intensity on all points, both of the mass itself and of the vessel in which it is contained. For it is a necessary consequence of the elasticity and fluidity of gases, that the repulsive force between the molecules is the same at all points, and acts equally in all directions. This principle of the equality of the pressure of gases in all directions may be shown experimentally by means of an apparatus resembling that by which the same principle is demonstrated for liquids (fig. 61).

If we consider the weight of any gas we shall see that it gives rise to pressures which obey the same laws as those produced by the weight of liquids. Let us imagine a cylinder, with its axis vertical, several miles high, closed at both ends and full of air. Let us consider any small portion of the air enclosed between two horizontal planes. This portion must sustain the weight of all the air above it, and transmit that weight to the air beneath it, and likewise to the curved surface of the cylinder which contains it; and at each point in a direction at right angles to the surface. Thus the pressure increases from the top of the column to the base; at any given layer, it acts equally on equal surfaces, and at right angles to them, whether they are horizontal, vertical, or inclined. The pressure acts on the sides of the vessel, and on any small surface it is equal to the weight of a column of gas, whose base is this surface, and whose height its distance from the summit of the column. The pressure is also independent of the shape and dimensions of the supposed cylinder, provided the height remains the same.

For a small quantity of gas the pressures due to its weight are quite insignificant, and may be neglected; but for large quantities, like the atmosphere, the pressures are considerable, and must be allowed for.

**151. The atmosphere. Its composition.**—The atmosphere is the layer of air which surrounds our globe in every part. It partakes of the rotatory motion of the globe, and would remain fixed relatively to terrestrial objects, but for local circumstances, which produce winds, and are constantly disturbing its equilibrium.

It is essentially a mixture of oxygen and nitrogen gases; its average composition by volume being as follows:—

Nitrogen . . . . .	78.49
Oxygen . . . . .	20.63
Aqueous vapour . . . . .	0.84
Carbonic acid . . . . .	0.04
	<hr/>
	100.00

The carbonic acid arises from the respiration of animals, from the processes of combustion, and from the decomposition of organic substances. M. Boussingault has estimated that in Paris the following quantities of carbonic acid are produced every 24 hours :—

By the population and by animals . . . . .	11,895,000	culic feet
By processes of combustion . . . . .	92,101,000	”
	<hr/>	
	103,996,000	

Notwithstanding this enormous continual production of carbonic acid the composition of the atmosphere does not vary ; for plants in the process of vegetation decompose the carbonic acid, assimilating the carbon and restoring to the atmosphere the oxygen, which is being continually consumed in the processes of respiration and combustion.

**152. Atmospheric pressure.**—If we neglect the perturbations to which the atmosphere is subject, as being inconsiderable, we may consider it as a fluid sea of a certain depth, surrounding the earth on all sides, and exercising the same pressure as if it were a liquid of very small density. Consequently, the pressure on the unit of area is constant at a given level, being equal to the weight of the column of atmosphere above that level whose horizontal section is the unit of area. It will act at right angles to the surface, whatever be its position. It will diminish as we ascend, and increase as we descend from that level. Consequently, at the same height, the atmospheric pressures on unequal plane surfaces will be proportional to the areas of those surfaces, provided they be small in proportion to the height of the atmosphere.

In virtue of the expansive force of the air, it might be supposed that the molecules would expand indefinitely into the planetary spaces. But, in proportion as the air expands, its expansive force decreases, and is further weakened by the low temperature of the upper regions of the atmosphere, so that, at a certain height, an equilibrium is established between the expansive force which separates the molecules, and the action of gravity which draws them towards the centre of the earth. It is therefore concluded that the atmosphere is limited.

From the weight of the atmosphere, and its increase in density, and from the observation of certain phenomena of twilight, its height has been estimated at from 30 to 40 miles. Above that height the air is extremely rarefied, and at a height of 60 miles it is assumed that there is a perfect vacuum. On the other hand meteorites have been seen at a height of 200 miles, and as their luminosity is undoubtedly due to the action of air, there must be air at such a height. This higher estimate is supported by observations made at Rio Janeiro on the twilight arc, by M. Liais, who estimates the height of the atmosphere at between 198 and 212 miles. The question as to the exact height of the atmosphere must therefore be considered as still awaiting settlement.



As it has been previously stated that 100 cubic inches of air weigh 31 grains, it will readily be conceived that the whole atmosphere exercises a considerable pressure on the surface of the earth. The existence of this pressure is shown by the following experiments.

153. **Crushing force of the atmosphere.**—On one end of a stout glass cylinder, about 5 inches high, and open at both ends, a piece of bladder is tied quite air-tight. The other end, the edge of which is ground and well-greased, is pressed on the plate of the air-pump (fig. 116). As soon as the air in the vessel is rarefied, by working the air-pump, the bladder is depressed by the weight of the atmosphere above it, and finally bursts with a loud report caused by the sudden entrance of the air.

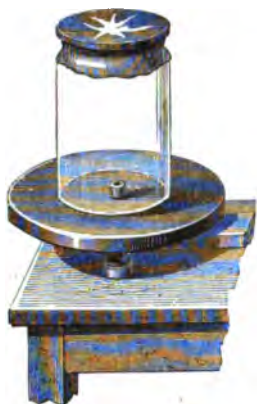

Fig. 116.

154. **Magdeburg hemispheres.**—The preceding experiment only serves to illustrate the downward pressure of the atmosphere. By means of the *Magdeburg hemispheres* (figs. 117 and 118), the invention of which is due to Otto von Guericke, burgomaster of Magdeburg, it can be shown that the pressure acts in all directions. This apparatus consists of two hollow brass hemispheres of 4 to 4½ inches diameter, the edges of which are made to fit tightly, and are well greased. One of the hemispheres is provided with a stopcock, by which it can be screwed on the air-pump, and on the other there



Fig. 117.



Fig. 118.

is a handle. As long as the hemispheres contain air they can be separated without any difficulty, for the external pressure of the atmosphere is counter-

balanced by the elastic force of the air in the interior. But when the air in the interior is pumped out by means of the air-pump, the hemispheres cannot be separated without a powerful effort; and as this is the case in whatever position they are held, it follows that the atmospheric pressure is transmitted in all directions.

#### DETERMINATION OF THE ATMOSPHERIC PRESSURE. BAROMETERS.

155. **Torricelli's experiment.**—The above experiments demonstrate the existence of the atmospheric pressure, but they give no precise indications as to its amount. The following experiment, which was first made, in 1643, by Torricelli, a pupil of Galileo, gives an exact measure of the weight of the atmosphere.

A glass tube is taken, about a yard long and a quarter of an inch internal diameter (fig. 119). It is sealed at one end, and is quite filled with mercury. The aperture C being closed by the thumb, the tube is inverted, the open end placed in a small mercury trough, and the thumb removed. The tube being in a vertical position, the column of mercury sinks, and, after oscillating some time, it finally comes to rest at a height A, which at the level of the sea is about 30 inches above the mercury in the trough. The mercury is raised in the tube by the pressure of the atmosphere on the mercury in the trough. There is no contrary pressure on the mercury in the tube, because it is closed. But if the end of the tube be opened, the atmosphere will press equally inside and outside the tube, and the mercury will sink to the level of that in the trough. It has been shown in hydrostatics (108) that the heights of two columns of liquid in communication with each other are inversely as their densities, and hence it follows that the pressure of the atmosphere is equal to that of a column of mercury, the height of which is 30 inches. If, however, the weight of the atmosphere diminishes, the height of the column which it can sustain must also diminish.

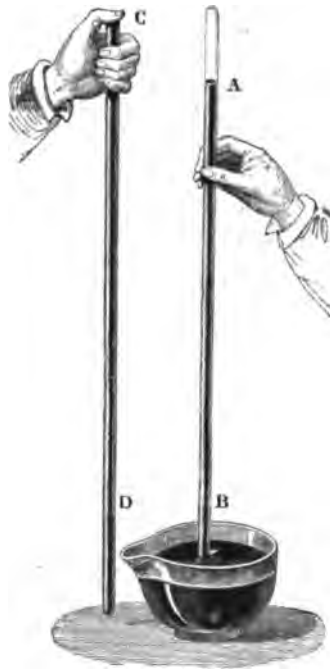

Fig. 119.

156. **Pascal's experiments.**—Pascal, who wished to prove that the force which sustained the mercury in the tube was really the pressure of the atmosphere, made the following experiments. i. If it were the case, the column of mercury ought to descend in proportion as we ascend in the atmosphere. He accordingly requested one of his relations to repeat Torricelli's experiment on the summit of the Puy de Dôme in Auvergne.

This was done, and it was found that the mercurial column was about 3 inches lower, thus proving that it is really the weight of the atmosphere which supports the mercury, since, when this weight diminishes, the height of the column also diminishes. ii. Pascal repeated Torricelli's experiment at Rouen, in 1646, with other liquids. He took a tube closed at one end, nearly 50 feet long, and having, filled it with water, placed it vertically in a vessel of water, and found that the water stood in the tube at a height of 34 feet; that is, 13·6 times as high as mercury. But since mercury is 13·6 times as heavy as water, the weight of the column of water was exactly equal to that of the column of mercury in Torricelli's experiment, and it was consequently the same force, the pressure of the atmosphere, which successively supported the two liquids. Pascal's other experiments with oil and with wine gave similar results.

157. **Amount of the atmospheric pressure.**—Let us assume that the tube in the above experiment is a cylinder, the section of which is equal to a square inch, then, since the height of the mercurial column in round numbers is 30 inches, the column will contain 30 cubic inches, and as a cubic inch of mercury weighs 3433·5 grains = 0·49 of a pound, the pressure of such a column on a square inch of surface is equal to 14·7 pounds. In round numbers the pressure of the atmosphere is taken at 15 pounds on the square inch. A surface of a foot square contains 144 square inches, and therefore the pressure upon it is equal to 2,160 pounds, or nearly a ton. Expressed in the metrical system, the standard atmospheric pressure at 0° and the sea level is 760 millimetres, which is equal to 29·9217 inches; and a similar calculation to the above shows that the pressure on a square centimetre is = 1·03296 kilogramme.

A gas or liquid which acts in such a manner that a square inch of surface is exposed to a pressure of 15 pounds, is called a pressure of *one atmosphere*. If, for instance, the elastic force of the steam of a boiler is so great that each square inch of the internal surface is exposed to a pressure of 90 pounds (= 6 × 15), we say it is under a pressure of six atmospheres.

The surface of the body of a man of middle size is about 16 square feet; the pressure, therefore, which a man supports on the surface of his body is 35,560 pounds, or nearly 16 tons. Such an enormous pressure might seem impossible to be borne; but it must be remembered that in all directions there are equal and contrary pressures which counterbalance one another. It might also be supposed that the effect of this force, acting in all directions, would be to press the body together and crush it. But the solid parts of the skeleton could resist a far greater pressure; and as to the air and liquids contained in the organs and vessels, the air has the same density as the external air, and cannot be further compressed by the atmospheric pressure; and from what has been said about liquids (98) it is clear that they are virtually incompressible. When the external pressure is removed from any part of the body, either by means of a cupping vessel or by the air-pump, the pressure from within is seen by the distension of the surface.

158. **Different kinds of barometers.**—The instruments used for measuring the atmospheric pressure are called *barometers*. In ordinary barometers, the pressure is measured by the height of a column of mercury, as in Torricelli's experiment: the barometers which we are about to describe

are of this kind. But there are barometers without any liquid, one of which, the aneroid (180), is remarkable for its simplicity and portability.

159. **Cistern barometer.**—The *cistern barometer* consists of a straight glass tube closed at one end, about 33 inches long, filled with mercury, and dipping into a cistern containing the same metal. In order to render the barometer more portable, and the variations of the level in the cistern less perceptible when the mercury rises or falls in the tube, several different



Fig. 120.



Fig. 121.



Fig. 122.

forms have been constructed. Fig. 120 represents one form of the cistern barometer. The apparatus is fixed to a mahogany stand, on the upper part of which there is a scale graduated in millimetres or inches from the level of the mercury in the cistern; a moveable index, *i*, shows on the scale the level of the mercury. A thermometer on one side of the tube indicates the temperature.

There is one fault to which this barometer is liable, in common with all others of the same kind. The zero of the scale does not always correspond

to the level of the mercury in the cistern. For as the atmospheric pressure is not always the same, the height of the mercurial column varies : sometimes mercury is forced from the cistern into the tube, and sometimes from the tube into the cistern, so that, in the majority of cases, the graduation of the barometer does not indicate the true height. If the diameter of the cistern is large, relatively to that of the tube, the error from this source is lessened. The *height* of the barometer is the distance between the levels of the mercury in the tube and in the cistern. Hence the barometer should always be perfectly vertical ; for, if not, the tube being inclined, the column of mercury is elongated (fig. 121), and the number read off on the scale is too great. As the pressure which the mercury exerts by its weight at the base of the tube is independent of the form of the tube and of its diameter (102), provided it is not capillary, the height of the barometer is independent of the diameter of the tube and of its shape, but is inversely as the density of the liquid. With mercury the mean height at the level of the sea is 29·92, or in round numbers 30, inches ; in a water barometer it would be about 34 feet, or 10·33 metres.

The 'Philosophical Magazine,' vol. xxx. Fourth Series, page 349, contains a detailed account of a method of constructing a water barometer.

160. **Fortin's barometer.**—*Fortin's barometer* differs from that just described, in the shape of the cistern. The base of the cistern is made of leather, and can be raised or lowered by means of a screw ; this has the advantage, that a constant level can be obtained, and also that the instrument is made more portable. For, in travelling, it is only necessary to raise the leather until the mercury, which rises with it, quite fills the cistern ; the barometer may then be inclined, and even inverted, without any fear that a bubble of air may enter, or that the shock of the mercury may crack the tube.

Fig. 122 represents the arrangement of the barometer, the tube of which is placed in a brass case. At the top of this case there are two longitudinal apertures, on opposite sides, so that the level of the mercury, B, is seen. The scale on the case is graduated in millimetres. An index A, moved by the hand, gives, by means of a vernier, the height of the mercury to  $\frac{1}{10}$ th of a millimetre. At the bottom of the case there is a cistern *b*, containing mercury, O.

Fig. 123 shows the details of the cistern on a larger scale. It consists of a glass cylinder *b*, through which the mercury can be seen ; this is closed at the top by a box-wood disc fitted on the under surface of the brass cover M. Through this passes the barometer tube E, which is drawn out at the end, and dips in the mercury ; the cistern and the tube are connected by a piece of buckskin *ce*, which is firmly tied at *c* to a contraction in the tube, and at *e* to a brass tubulure in the cover of the cistern. This mode of closing prevents the mercury from escaping when the barometer is inverted, while the pores of the leather transmit the atmospheric pressure. The bottom of the cylinder *b* is cemented on a box-wood cylinder *xx*, on a contraction in which, *ii*, is firmly tied the buckskin *mn*, which forms the base of the cistern. On this skin is fastened a wooden button *x*, which rests against the end of a screw C. According as this is turned in one direction or the other, the skin *mn* is raised or lowered ; and with it the mercury. In using

this barometer the mercury is first made exactly level with the point *a*, which is effected by turning the screw *C* either in one direction or the other. The graduation of the scale is counted from this point *a*, and thus the distance of the top *B* of the column of mercury from *a* gives the height of the barometer. The bottom of the cistern is surrounded by a brass case, which is fastened to the cover *M* by screws, *k, k, k*. We have already seen (159) the importance of having the barometer quite vertical, which is effected by the following plan, known as *Cardan's suspension*.

The metal case containing the barometer is fixed in a copper sheath *X* by two screws *a* and *b* (fig. 124). This is provided with two axes (only one



Fig. 123.



Fig. 124.

of which, *o*, is seen in the figure), which turn freely in two holes in a ring *Y*. In a direction at right angles to that of the axes, *oo*, the ring has also two similar axes, *m* and *n*, resting on a support *Z*. By means of this double suspension, the barometer can oscillate freely about the axes, *mn* and *oo*, in two directions at right angles to each other. But as care is taken that the point at which these axes cross corresponds to the tube itself, the centre of gravity of the system, which must always be lower than the axis of suspension, is below the point of intersection, and the barometer is then perfectly vertical.

161. **Gay-Lussac's syphon barometer.**— The syphon barometer is a bent glass tube, one of the branches of which is much longer than the other. The longer branch, which is closed at the top, is filled with mercury as in the cistern barometer, while the shorter branch, which is open, serves as a cistern. The difference between the two levels is the height of the barometer.

Fig. 125 represents the syphon barometer as modified by Gay-Lussac. In order to render it more available for travelling by preventing the entrance of air, he joined the two branches by a capillary tube (fig. 126); when the



Fig. 125.



Fig. 126.



Fig. 127.



Fig. 128.

instrument is inverted (fig. 127) the tube always remains full in virtue of its capillarity, and air cannot penetrate into the longer branch. A sudden shock, however, might separate the mercury and admit some air. To avoid this, M. Bunten has introduced an ingenious modification into the apparatus. The longer branch is drawn out to a fine point, and is joined to a tube B, of

the form represented in fig. 128. By this arrangement, if air passes through the capillary tube it cannot penetrate the drawn-out extremity of the longer branch, but lodges in the upper part of the enlargement B. In this position it does not affect the observations, since the vacuum is always at the upper part of the tube; it is moreover easily removed.

In Gay-Lussac's barometer the shorter branch is closed, but there is a lateral capillary aperture *i*, through which the atmospheric pressure is transmitted.

The barometric height is determined by means of two scales, which have a common zero at O, towards the middle of the longer branch, and are graduated in contrary directions, the one from O to E, and the other from O to B, either on the tube itself, or on brass rules fixed parallel to the tube. Two sliding verniers, *m* and *n*, indicate tenths of a millimetre. The total height of the barometer, AB, is the sum of the distances from O to A and from O to B.

**162. Precautions in reference to barometers.**—In constructing barometers, mercury is chosen in preference to any other liquid. For being the densest of all liquids, it stands at the least height. When the mercurial barometer stands at 30 inches, the water barometer would stand at about 34 feet (159). It also deserves preference because it does not moisten the glass. It is necessary that the mercury be pure and free from oxide; otherwise it adheres to the glass and tarnishes it. Moreover, if it is impure its density is changed, and the height of the barometer is too great or too small. Mercury is purified, before being used for barometers, by treatment with dilute nitric acid, and by distillation.

The space at the top of the tube (figs. 120 and 125), which is called the *Torricellian vacuum*, must be quite free from air and from aqueous vapour, for otherwise either would depress the mercurial column by its elastic force. To obtain this result, a small quantity of pure mercury is placed in the tube and boiled for some time. It is then allowed to cool, and a further quantity, previously warmed, added, which is boiled, and so on, until the tube is quite full; in this manner the moisture and the air which adhere to the sides of the tube pass off with the mercurial vapour. A barometer tube should not be too narrow, for otherwise the mercury is moved with difficulty; and before reading off the barometer should be tapped so as to get rid of the adhesion to the glass.

A barometer is free from air and moisture if, when it is inclined, the mercury strikes with a sharp metallic sound against the top of the tube. If there is air or moisture in it, the sound is deadened.

**163. Correction for capillarity.**—In cistern barometers there is always a certain depression of the mercurial column due to capillarity, unless the internal diameter of the tube exceeds 0.8 inch. To make the correction due to this depression, it is not enough to know the diameter of the tube; we must also know the height of the meniscus *od* (fig. 129), which varies according as the meniscus has been formed during an ascending or descending motion of the mercury in the tube. Consequently the height of the meniscus must be determined by

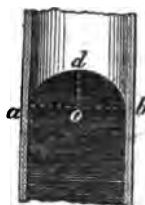

Fig. 129.



bringing the pointer to the level *ab*, and then to the level *d*, when the difference of the readings will give the height *od* required. These two terms, namely, the internal diameter of the tube and the height of the meniscus, being known, the resulting correction can be taken out of the following table:

Internal Diameter in inches.	Height of Sagitta of Meniscus in inches.						
	0'010	0'015	0'020	0'025	0'030	0'035	0'040
0'157	0'0293	0'0431	0'0555	0'0677	0'0780	0'0870	0'0948
0'236	0'0119	0'0176	0'0231	0'0294	0'0342	0'0398	0'0432
0'315	0'0060	0'0088	0'0118	0'0144	0'0175	0'0196	0'0221
0'394	0'0039	0'0048	0'0063	0'0078	0'0095	0'0110	0'0125
0'472	0'0020	0'0029	0'0036	0'0045	0'0053	0'0063	0'0073
0'550	0'0010	0'0017	0'0024	0'0029	0'0034	0'0039	0'0044

In Gay-Lussac's barometer the two tubes are made of the same diameter, so that the error caused by the depression in the one tube very nearly corrects that caused by the depression in the other. As however, the meniscus in the one tube is formed by a column of mercury with an ascending motion, while that in the other by a column with a descending motion, their heights will not be the same, and the reciprocal correction will not be quite exact.

164. **Correction for temperature.**—In all observations with barometers, whatever be their construction, a correction must be made for temperature. Mercury contracts and expands with different temperatures; hence its density changes, and consequently the barometric height, for this height is in the inverse ratio of the density of the mercury; so that for different atmospheric pressures the mercurial column might have the same height. Accordingly, in each observation, the height observed must be reduced to a determinate temperature; the choice of this is quite arbitrary, but that of melting ice is always adopted. It will be seen, in the Book on Heat, how this correction is made.

165. **Variations in the height of the barometer.**—When the barometer is observed for several days, its height is found to vary in the same place, not only from one day to another, but also during the same day.

The extent of these variations, that is, the difference between the greatest and the least height, is different in different places. It increases from the equator towards the poles. Except under extraordinary circumstances, the greatest variations do not exceed six millimetres under the equator, 30 under the tropic of Cancer, 40 in France, and 60 at 25 degrees from the pole. The greatest variations are observed in winter.

The *mean daily height* is the height obtained by dividing the sum of 24 successive hourly observations by 24. In our latitudes the barometric height at noon corresponds to the mean daily height.

The *mean monthly height* is obtained by adding together the mean daily heights for a month, and dividing by 30. The *mean yearly height* is similarly obtained.

Under the equator, the mean annual height at the level of the sea is 0<sup>m</sup>·758, or 29<sup>·</sup>84 inches. It increases from the equator, and between the latitudes 30° and 40° it attains a maximum of 0<sup>m</sup>·763, or 30<sup>·</sup>04 inches. In lower latitudes it decreases, and in Paris it does not exceed 0<sup>m</sup>·7568.

The general mean at the level of the sea is 0<sup>m</sup>·761, or 29<sup>·</sup>96 inches.

The mean monthly height is greater in winter than in summer, in consequence of the cooler atmosphere.

Two kinds of variations are observed in the barometer:—1st, the *accidental variations*, which present no regularity; they depend on the seasons, the direction of the winds, and the geographical position, and are common in our climates; 2nd, the *daily variations*, which are produced periodically at certain hours of the day.

At the equator, and between the tropics, no accidental variations are observed; but the daily variations take place with such regularity that a barometer may serve to a certain extent as a clock. The barometer sinks from midday till towards four o'clock; it then rises, and reaches its maximum at about ten o'clock in the evening. It then again sinks, and reaches a second minimum towards four o'clock in the morning, and a second maximum at ten o'clock.

In the temperate zones there are also daily variations, but they are detected with difficulty, since they occur in conjunction with accidental variations.

The hours of the maxima and minima appear to be the same in all climates, whatever be the latitude; they merely vary a little with the seasons.

166. **Causes of barometric variations.**—It is observed that the course of the barometer is generally in the opposite direction to that of the thermometer; that is, that when the temperature rises the barometer falls, and *vice versa*; which indicates that the barometric variations at any given place are produced by the expansion or contraction of the air, and therefore by its change in density. If the temperature were the same throughout the whole extent of the atmosphere, no currents would be produced, and, at the same height, atmospheric pressure would be everywhere the same. But when any portion of the atmosphere becomes warmer than the neighbouring parts, its specific gravity is diminished, and it rises and passes away through the upper regions of the atmosphere, whence it follows that the pressure is diminished, and the barometer falls. If any portion of the atmosphere retains its temperature, while the neighbouring parts become cooler, the same effect is produced; for in this case, too, the density of the first-mentioned portion is less than that of the others. Hence, also, it usually happens that an extraordinary fall of the barometer at one place is counterbalanced by an extraordinary rise at another place. The daily variations appear to result from the expansions and contractions which are periodically produced in the atmosphere by the heat of the sun during the rotation of the earth.

167. **Relation of barometric variations to the state of the weather.**

It has been observed that, in our climate, the barometer in fine weather is generally above 30 inches, and is below this point when there is rain, snow, wind, or storm, and also, that for any given number of days at which the barometer stands at 30 inches, there are as many fine as rainy days. From this coincidence between the height of the barometer and the state of

the weather, the following indications have been marked on the barometer, counting by thirds of an inch above and below 30 inches :

Height	State of the weather
31 inches . . . . .	Very dry.
30 $\frac{2}{3}$ „ . . . . .	Settled weather.
30 $\frac{1}{3}$ „ . . . . .	Fine weather.
30 „ . . . . .	Variable.
29 $\frac{2}{3}$ „ . . . . .	Rain or wind.
29 $\frac{1}{3}$ „ . . . . .	Much rain.
29 „ . . . . .	Tempest.

In using the barometer as an indicator of the state of the weather, we must not forget that it really only serves to measure the weight of the atmosphere, and that it only rises or falls as the weight increases or diminishes ; and although a change of weather frequently coincides with a change in the pressure, they are not necessarily connected. This coincidence arises from meteorological conditions peculiar to our climate, and does not always occur. That a fall in the barometer usually precedes rain in our latitudes, is caused by the position of Europe. The south-west winds, which are hot and consequently light, make the barometer sink ; but at the same time, as they become charged with aqueous vapour in crossing the ocean, they bring us rain. The winds of the north and north-east, on the contrary, being colder and denser, make the barometer rise ; and as they only reach us after having passed over vast continents, they are generally dry.

When the barometer rises or sinks slowly, that is, for two or three days, towards fine weather or towards rain, it has been found from a great number of observations that the indications are then extremely probable. Sudden variations in either direction indicate bad weather or wind.

168. **Wheel barometer.**—The *wheel barometer*, which was invented by Hooke, is a syphon barometer, and is especially intended to indicate good and bad weather (fig. 130). In the shorter leg of the syphon there is a float, which rises and falls with the mercury (fig. 131). A string attached to this float passes round a pulley, O, and at the other end there is a weight, P, somewhat lighter than the float. A needle fixed to the pulley moves round a graduated circle, on which is marked, *variable, rain, fine weather*, etc. When the pressure varies the float sinks or rises, and moves the needle round to the corresponding points on the scale.

The barometers ordinarily met with in houses, and which are called *weather glasses*, are of this kind. They are, however, of little use, for two reasons. The first is, that they are neither very delicate nor precise in their indications. The second, which applies equally to all barometers, is that those commonly in use in this country are made in London, and the indications, if they are of any value, are only so for a place of the same level and of the same climatic conditions as London. Thus a barometer standing at a certain height in London would indicate a certain state of weather, but if removed to Shooter's Hill it would stand half an inch lower, and would indicate a different state of weather. As the pressure differs with the level and with geographical conditions, it is necessary to take these into account if exact data are wanted.

169. **Fixed barometer.**—For accurate observations Regnault uses a barometer the height of which he measures by means of a cathetometer (89). The cistern (fig. 132) is of cast iron; against the frame on which it is supported a screw is fitted, which is pointed at both ends, and the length of which has been determined, once for all, by the cathetometer. To measure the barometric height, the screw is turned until its point grazes the surface



Fig. 130.



Fig. 131.



Fig. 132.

of the mercury in the bath, which is the case when the point and its image are in contact. The distance then from the top of the point to the level of the mercury in the tube  $b$  is measured by the cathetometer, and this, together with the length of the screw, gives the barometric height with great accuracy. This barometer has moreover the advantage that, as a tube an inch in diameter may be used, the influence of capillarity becomes inappreciable. Its construction moreover is very simple, and the position of the scale leads to no kind of error, since this is transferred to the cathetometer. Unfortunately the latter instrument requires great accuracy in its construction, and is very expensive.

170. **Glycerine barometer.**—Jordan has recently constructed a barometer in which the liquid used is pure glycerine. This has the specific gravity 1.26, and therefore the length of the column of liquid is rather more than ten times that of mercury; hence small alterations in the atmospheric pressure produce considerable oscillations in the height of the liquid. The tube consists of ordinary composition gas tubing about  $\frac{5}{8}$  of an inch in diameter and 28 feet or so in length; the lower end is open and dips in the cistern which may be placed in a cellar; the top is sealed to a closed glass tube an inch in diameter, in which the fluctuations of the column are observed. This may be arranged in an upper story, and the tubing being easily bent lends itself to any adjustment which the locality requires.

The vapour of glycerine has very low tension at ordinary temperatures, and is therefore not so exposed to such back pressures, varying with the temperature, as is water. On the other hand, it readily attracts moisture from the air, whereby the density and therewith the height of the liquid column vary. This is prevented by covering the liquid in the cistern with a layer of paraffine oil.

171. **Determination of heights by the barometer.**—Since the atmospheric pressure decreases as we ascend, it is obvious that the barometer will keep on falling as it is taken to a greater and greater height. On this depends a method of determining the difference between the heights of two stations, such as the base and summit of a mountain. The method may be explained as follows.

It will be seen in the next chapter that, according to Boyle's law, if the temperature of an enclosed portion of air continues constant, its volume will vary inversely as the pressure. That is to say, if we double the pressure we shall halve the volume. But if we halve the volume we manifestly

double the quantity of air in each cubic inch, that is to say, we double the density of the air; and so on in any proportion. Consequently, the law is equivalent to this:—*That for a constant temperature the density of air is proportional to the pressure which it sustains.*

Now suppose A and B (fig. 133) to represent two stations, and that it is required to determine the vertical height of B above A; it being borne in mind that A and B are not necessarily in the same vertical line. Take P any point in AB, and Q a point at a small distance above P. Suppose the pressure on a square inch of the atmosphere at P to be denoted by  $p$ , and at Q let it be diminished by a quantity denoted by  $d\phi$ . It is plain that this diminution equals the weight of the column of air between P and Q, whose section is one square inch.

But, since the density of the air is directly proportional to  $p$ , the weight of a cubic inch of air will equal  $k\phi p$ , where  $k$  denotes a certain quantity to be determined hereafter, and  $g$  the accelerating force of gravity (80). Hence, if we denote PQ in inches by  $dx$ , the pressure will be diminished by  $k\phi g \cdot dx$ , and we may represent this algebraically by the equation

$$k\phi g \cdot dx = d\phi.$$

By a certain algebraical process this leads to the conclusion that

$$kgX = \log \frac{P}{P_1}$$

where  $X$  denotes the height of  $AB$ , and  $P$  and  $P_1$  the atmospheric pressures at  $A$  and  $B$  respectively, the logarithms being what are called 'Napierian logarithms.' Now, if  $H$  and  $H_1$  are the heights of the barometer at  $A$  and  $B$  respectively, the temperature of the mercury being the same at both stations, their ratio equals that of  $P$  to  $P_1$ , and therefore

$$X = \frac{1}{kg} \cdot \log \frac{H}{H_1}$$

It remains to determine  $k$  and  $g$ .

(1) Since the force of gravity is different for places in different latitudes,  $g$  will depend upon the latitude ( $\S 3$ ). It is found that if  $g$  is the accelerating force of gravity in latitude  $\phi$ , and  $f$  that force in latitude  $45^\circ$ , then

$$g = \frac{f}{1 + 0.00256 \cos 2\phi}$$

where  $f$  has a definite numerical value.

(2) From what has been stated above it will be seen, that if  $\rho$  is the density of air at a temperature of  $t^\circ \text{C.}$ , under  $Q$ , the pressure exerted by 29.92 inches of mercury, we shall have

$$kQ = \rho$$

But it will be afterwards shown that if  $\rho_0$  is the density of air under the same pressure  $Q$  at  $0^\circ \text{C.}$ , we shall have

$$\rho = \frac{\rho_0}{1 + at}$$

where  $a$  represents the coefficient of expansion of gases. Therefore

$$kQ = \frac{\rho_0}{1 + at}$$

Now if  $\sigma$  is the density of mercury, and if the latitude is  $45^\circ$ , we shall have

$$Q = 29.92 \cdot \sigma f;$$

and therefore

$$kf = \frac{\rho_0}{\sigma} \cdot \frac{1}{29.92 (1 + at)}$$

Now  $\rho_0 + \sigma$  is the ratio which the density of dry air at a temperature  $0^\circ \text{C.}$ , in latitude  $45^\circ$ , under a pressure of 29.92 inches of mercury, bears to the density of mercury at  $0^\circ \text{C.}$ , and therefore  $\rho_0 + \sigma$  is a determinate number.

Substituting, we have

$$X = 29.92 \text{ in.} \cdot \frac{\sigma}{\rho_0} (1 + 0.00256 \cos 2\phi) \cdot (1 + at) \log \frac{H}{H_1}$$

The value of  $a$  is 0.003665, which is nearly equal to  $\frac{11}{3000}$ . If we substitute the proper values for  $\sigma + \rho_0$ , and change the logarithms into common logarithms, and instead of  $t$  use the mean of  $T$  and  $T_1$ , the temperatures at the upper and lower stations, it will be found that

$$X \text{ (in feet)} = 60346 (1 + 0.00256 \cos 2\phi) \left( 1 + \frac{2(T + T_1)}{1000} \right) \log \frac{H}{H_1}$$

which is La Place's barometric formula. In using it, we must remember

that  $T$  and  $T_1$  are temperatures on the Centigrade thermometer, and that  $H$  and  $H_1$  are the heights of the barometer reduced to  $0^\circ$  C. Thus if  $h$  is the measured height of the barometer at the lower station we have

$$H = h \left( 1 - \frac{t}{6500} \right)$$

If the height to be measured is not great, one observer is enough. For greater heights the ascent takes some time, and in the interval the pressure may vary. Consequently in this case there must be two observers, one at each station, who make simultaneous observations.

Let us take the following example of the above formula:—Suppose that in latitude  $65^\circ$  N. at the lower of the two stations the height of the barometer were  $30\cdot025$  inches, and the temperature of air and mercury  $17\cdot32$  C., while at the upper the height of the barometer was  $28\cdot230$  inches, and the temperature of air and mercury was  $10\cdot55$  C. Determine the height of the upper station above the lower.

(1) Find  $H$  and  $H_1$ : viz.

$$H = 30\cdot025 \left( 1 - \frac{17\cdot32}{6500} \right) = 29\cdot945$$

$$H_1 = 28\cdot230 \left( 1 - \frac{10\cdot55}{6500} \right) = 28\cdot184$$

$$\text{Hence } \log \frac{H}{H_1} = 1\cdot4763243 - 1\cdot4500026 = 0\cdot0263217$$

(2) Find  $1 + \frac{2(T+T_1)}{1000}$  viz.  $1\cdot05574$

(3) Find  $1 + 0\cdot00256 \cos 2\phi$

Since  $0\cdot00256 \cos 130^\circ = -0\cdot00256 \cos 50^\circ = -0\cdot001645$

therefore  $1 + 0\cdot00256 \cos 2\phi = -0\cdot998355$

Hence the required height in feet equals

$$60346 \times 0\cdot998355 \times 1\cdot05574 \times 0\cdot0263217 = 1674$$

It may be easily proved that if  $H$  and  $H_1$  do not greatly differ, the Napierian logarithm of  $\frac{H}{H_1}$  equals  $2 \frac{H-H_1}{H+H_1}$ . If for instance  $H$  equals 30 inches, and  $H_1$  equals 29 inches, the resulting error would not exceed the  $\frac{1}{5000}$  part of the whole. Accordingly for heights not exceeding 2000 ft. we may without much error use the formula,

$$X \text{ (in feet)} = 52500 \left( 1 + \frac{2(T+T_1)}{1000} \right) \times \frac{H-H_1}{H+H_1}$$

172. **Ruhmann's observations.**—The results obtained for the difference in height of places by using the above formula often differ from the true heights as measured trigonometrically to an extent which cannot be ascribed to errors in observation. The numbers thus found for the heights of places are influenced by the time of day, and also by the season of year, at which they are made. Ruhmann has investigated the cause of this discrepancy by a series of direct barometric and thermometric observations

made at two different stations in Saxony, and also by a comparison of the continuous series of observations made at Geneva and on the St. Bernhard.

Ruhlmann has ascertained thus that the cause of the discrepancy is to be found in the fact that the mean of the temperatures indicated by the thermometer at the two stations is not an accurate measure of the actual mean temperature of the column of air between the two stations, a condition which is assumed in the above formula. The variations in the temperature of the column of air are not of the same extent as those indicated by the thermometer, nor do they follow them so rapidly; they drag after them as it were. If the mean monthly temperatures at the two fixed stations are introduced into the formula, they give in winter heights which are somewhat too low, and in summer such as are too high. The results obtained by introducing the mean yearly temperature of the two stations are very near the true ones.

This influence of temperature is most perceptible in individual observations of low heights. Thus, using the observed temperatures in the barometric formula, the error in height of the Uetliberg above Zurich (about 1700 feet) was found to be  $\frac{1}{25}$  of the total, while the height of the St. Bernhard above Geneva was found within  $\frac{1}{138}$  of the true height.

The reason the thermometers do not indicate the true temperature of the air is undoubtedly that they are too much influenced by radiation from the earth and surrounding bodies. The earth is highly absorbent, and becomes rapidly heated under the influence of the sun's rays, and becomes as rapidly cooled at night; the air, as a very diathermanous body, is but little heated by the sun's rays, and on the contrary is little cooled by radiation during the night.

## CHAPTER II.

### MEASUREMENT OF THE ELASTIC FORCE OF GASES.

173. **Boyle's law.**—The law of the compressibility of gases was discovered by Boyle in 1662, and afterwards independently by Mariotte in 1679. It is in England commonly called 'Boyle's law,' and, on the Continent, 'Mariotte's law.' It is as follows:

*The temperature remaining the same, the volume of a given quantity of gas is inversely as the pressure which it bears.*

This law may be verified by means of an apparatus devised by Boyle (fig. 134). It consists of a long glass tube fixed to a vertical support; it is open at the upper part, and the other end, which is bent into a short vertical leg, is closed. On the shorter leg there is a scale, which indicates equal capacities; the scale against the long leg gives the heights. The zero of both scales is in the same horizontal line.

A small quantity of mercury is poured into the tube, so that its level in both branches is at zero, which is effected without much difficulty after a few trials (fig. 134). The air in the short leg is thus under the ordinary atmospheric pressure which is exerted through the open tube. Mercury is then poured into the longer tube until the volume of the air in the smaller tube is reduced to one-half; that is, until it is reduced from 10 to 5, as shown in



fig. 135. If the height of the mercurial column, CA, be measured, it will be found exactly equal to the height of the barometer at the time of the experiment. The pressure of the column CA is therefore equal to an atmosphere which, with the atmospheric pressure acting on the surface of the column at C, makes two atmospheres. Accordingly, by doubling the pressure, the volume of the gas has been diminished to one-half.

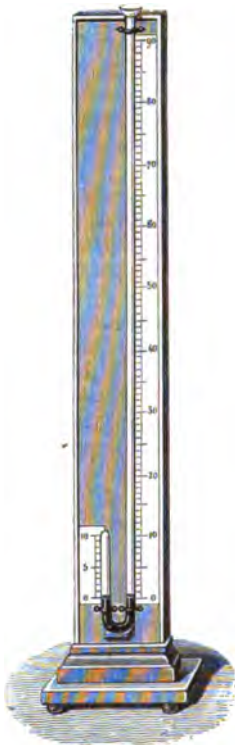

Fig. 134.

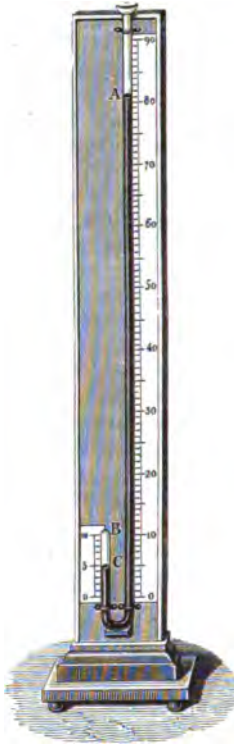

Fig. 135.



Fig. 136. Fig. 137.

If mercury be poured into the longer branch until the volume of the air is reduced to one-third its original volume, it will be found that the distance between the level of the two tubes is equal to two barometric columns. The pressure is now three atmospheres, while the volume is reduced to one-third. Dulong and Petit have verified the law for air up to 27 atmospheres, by means of an apparatus analogous to that which has been described.

The law also holds good in the case of pressures of less than one atmosphere. To establish this, mercury is poured into a graduated tube until it is about two-thirds full, the rest being air. It is then inverted in a deep trough containing mercury (fig. 136), and lowered until the levels of the

mercury inside and outside the tube are the same, and the volume noted. The tube is then raised, as represented in the figure, until the volume of air AC is double that of AB (fig. 137). The height of the mercury in the tube above the mercury in the trough CD, is then found to be exactly half the height of the barometric column. The air, whose volume is now doubled, is now only under the pressure of half an atmosphere; for it is the elastic force of this air which, added to the weight of the column CD, is equivalent to the atmospheric pressure. Hence the volume is inversely as the pressure.

In the experiment with Mariotte's tube, as the quantity of air remains the same, its density must obviously increase as its volume diminishes, and *vice versa*. The law may thus be enunciated: '*For the same temperature the density of a gas is proportional to its pressure.*' Hence as water is 773 times as heavy as air, under a pressure of 773 atmospheres, air would be as dense as water.

Boyle's law must not be understood to mean that gases of equal density have equal elastic force; different gases of various densities have the same tension when they are under the same pressure. A given volume of hydrogen under the ordinary atmospheric pressure has the same elastic force as the same volume of air, although the latter is 14 times as heavy as the former. Since, for the same volume, there are the same number of atoms in all gases, the lighter atoms must possess a greater velocity in order to exert the same pressure as the same number of atoms of greater mass.

**174. Boyle's law is only approximately true.**—Until within the last few years Boyle's law was supposed to be absolutely true for all gases at all pressures, but Despretz, who examined the compressibility of gases, obtained results incompatible with the law. He took two graduated glass tubes of the same length, and filled one with air and the other with the gas to be examined. These tubes were placed in the same mercury trough, and the whole apparatus immersed in a strong glass cylinder filled with water. By means of a piston moved by a screw which worked in a cap at the top of a cylinder, the liquid could be subjected to an increasing pressure, and it could be seen whether the compression of the two gases was the same or not. The apparatus resembled that used for examining the compressibility of liquids (fig. 60). In this manner Despretz found that carbonic acid, sulphuretted hydrogen, ammonia, and cyanogen, are more compressible than air: hydrogen, which has the same compressibility as air up to 15 atmospheres, is then less compressible. From these experiments it was concluded that the law of Boyle was not general.

In some experiments on the elastic force of vapours, Dulong and Arago had occasion to test the accuracy of Boyle's law. The method adopted was exactly that of Mariotte, but the apparatus had gigantic dimensions.

The gas to be compressed was contained in a strong glass tube, GF (fig 138), about six feet long and closed at the top, G. The pressure was produced by a column of mercury, which could be increased to a height of 65 feet, contained in a long vertical tube, KL, formed of a number of tubes firmly joined by good screws, so as to be perfectly tight.

The tubes KL and GF were hermetically fixed in a horizontal iron pipe

DE, which formed part of a mercurial reservoir, A. On the top of this reservoir there was a force pump, BC, by which mercury could be forced into the apparatus.

At the commencement of the experiment, the volume of the air in the manometer (177) was observed, and the initial pressure determined, by adding to the pressure of the atmosphere the height of the mercury in K above its level in H. If the level of the mercury in the manometer had

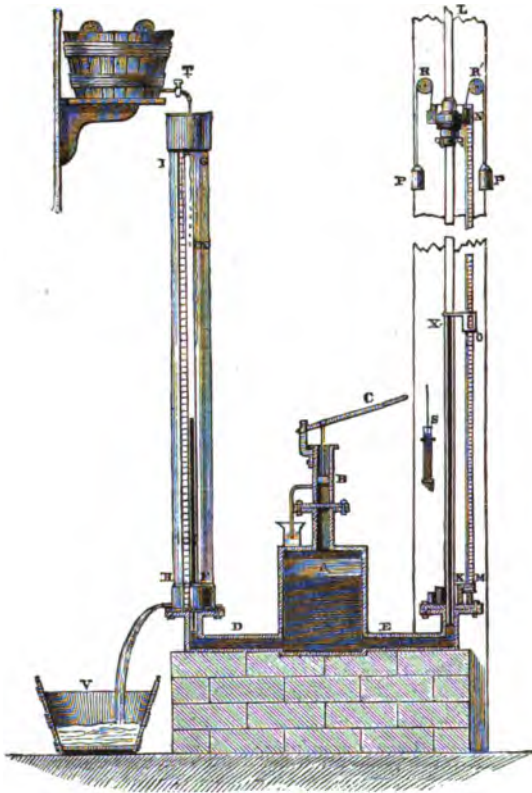

Fig. 138.

been above the level in KL, it would have been necessary to subtract the difference.

By means of the pump, water was injected into A. The mercury being then pressed by the water, rose in the tube GF, where it compressed the air, and in the tube KL, where it rose freely. It was only then necessary to measure the volume of the air in GF; the height of the mercury in KL above the level in GF, together with the pressure of the atmosphere, was

the total pressure to which the gas was exposed. These were all the elements necessary for comparing different volumes and the corresponding temperatures. The tube GF was kept cold during the experiment by a stream of cold water.

The long tube was attached to a long mast by means of staples. The individual tubes were supported at the junction by cords, which passed round pulleys R and R', and were kept stretched by small buckets, P, containing shot. In this manner, each of the thirteen tubes having been separately counterpoised, the whole column was perfectly free notwithstanding its weight.

Dulong and Arago experimented with pressures up to 27 atmospheres, and observed that the volume of air always diminished a little more than is required by Boyle's law. But as these differences were very small, they attributed them to errors of observation, and concluded that the law was perfectly exact, at any rate up to 27 atmospheres.

M. Regnault investigated ~~the same~~ subject with an apparatus resembling that of Dulong and Arago, but in which all the sources of error were taken into account, and the observations made with remarkable precision. He experimented with air, nitrogen, carbonic acid, and hydrogen. He found that air does not exactly follow Boyle's law, but experiences a greater compressibility, which increases with the pressure; so that the difference between the calculated and the observed diminution of volume is greater in proportion as the pressure increases.

M. Regnault found that nitrogen was like air, but is less compressible. Carbonic acid exhibits considerable deviation from Boyle's law even under small pressures. Hydrogen also deviates from the law, but its compressibility diminishes with increased pressure.

Recently M. Cailletet has examined the compressibility of gases by a special method in which the pressure could be carried as high as 600 atmospheres. His results confirm those of M. Regnault as regards hydrogen; air was found to present the curious feature that towards 80 atmospheres it has a *maximum relative compressibility*; beyond this point it gradually becomes less compressible, its compressibility diminishing more rapidly than that of hydrogen. Carbonic acid deviates less from the law in proportion as the temperature is higher. This is also the case with other gases. And experiment shows that the deviation from the law is greater in proportion as the gas is nearer its liquefying point; and, on the contrary, the farther a gas is from this point, the more closely does it follow the law. For gases which have not been liquefied, the deviations from the law are inconsiderable, and may be quite neglected in ordinary physical and chemical experiments, where the pressures are not great.

175. **Applications of Boyle's law.**—Observations on the volumes of gases are only comparable when made at the same pressure. Usually, therefore, in gas analyses, all measurements are reduced to the standard pressure of 760 millimetres, or 29.92 inches. This is easily done by Boyle's law, for, since the volumes are inversely as the pressures,  $V : V' = P' : P$ . Knowing the volume  $V$  at the pressure  $P$ , we can easily calculate its volume  $V'$  at the given pressure  $P'$ , for

$$V'P' = VP$$

that is,

$$V' = \frac{VP}{P'}$$

Suppose a volume of gas to measure 340 cubic inches under a pressure of 535 mm., what will be its volume at the standard pressure, 760 mm. ?

We have  $V = \frac{340 \times 535}{760} = 238$  cubic inches.

In like manner let it be asked, if  $D'$  is the density of a gas when the barometer stands at  $H'$  mm., what will be its density  $D$  at the same temperature when the barometer stands at  $H$  mm. ? Let  $M$  be the mass of the gas,  $V'$  its volume in the first case,  $V$  its volume in the second. Therefore,

$$DV = M = D'V'$$

or, 
$$\frac{D}{D'} = \frac{V'}{V} = \frac{P}{P'} = \frac{H}{H'}$$

Thus, if  $H'$  denote 760 mm., we have

$$\text{Density at } H = (\text{Density at standard pressure}) \frac{H}{760}$$

176. **Manometers.**—Manometers are instruments for measuring the tension of gases or vapours. In all manometers the unit chosen is the pressure of one atmosphere or 30 inches of mercury at the standard temperature, which, as we have seen, is nearly 15 lbs. to the square inch.

177. **Open-air manometer.**—The open-air manometer consists of a bent glass tube BD (fig. 139), fastened to the bottom of a reservoir AC, of the same material, containing mercury, which is connected with the closed recipient containing the gas or vapour the pressure of which is to be measured. The whole is fixed on a long plank kept in a vertical position.

In graduating this manometer C is left open, and the number 1 marked at the level of the mercury, for this represents one atmosphere. From this point the numbers 2, 3, 4, 5, 6 are marked at each 30 inches, indicating so many atmospheres, since a column of mercury 30 inches represents a pressure of one atmosphere. The intervals from 1 to 2, and from 2 to 3, &c., are divided into tenths. C being then placed in connection with a boiler, for example, the mercury rises in the tube BD to a height which measures the tension of the vapour. In the figure the manometer marks 2 atmospheres, which represents a height of 30 inches, plus the atmospheric pressure exerted at the top of the column through the aperture D.

This manometer is only used when the pressures do not exceed 5 to 6 atmospheres. Beyond this, the length of tube necessary makes it very inconvenient, and the following apparatus is commonly used.

178. **Manometer with compressed air.**—The manometer with compressed air is founded on Boyle's law : it consists of a glass tube closed at the top, and filled with dry air. It is firmly cemented in a small iron box containing mercury. By a tubulure, A, in the side (fig. 140), this box is connected with the closed vessel containing the gas or vapour whose tension is to be measured.

In the graduation of this manometer, the quantity of air contained in the tube is such, that when the aperture A communicates freely with the atmosphere, the level of the mercury is the same in the tube and in the tubulure. Consequently, at this level, the number 1 is marked on the scale to which the tube is affixed. As the pressure acting through the tubulure A increases, the mercury rises in the tube; until its weight, added to the tension of the compressed air, is equal to the external pressure. It would consequently be

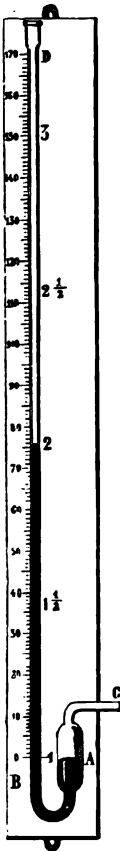

Fig. 139.



Fig. 140.

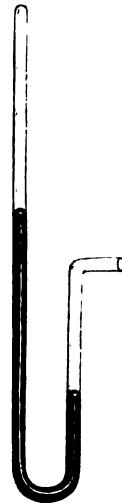

Fig. 141.

incorrect to mark two atmospheres in the middle of the tube ; for since the volume of the air is reduced to one-half, its tension is equal to two atmospheres, and, together with the weight of the mercury raised in the tube, is therefore more than two atmospheres. The position of the number is a little below the middle, at such a height that the elastic force of the com-

pressed air, together with the weight of the mercury in the tube, is equal to two atmospheres. The exact position of the numbers, 2, 3, 4, &c. on the manometer scale can only be determined by calculation. Sometimes this manometer is made of one glass tube, as represented in fig. 140. The principle is obviously the same.

179. **Regnault's barometric manometer.**—For measuring pressures of less than one atmosphere, M. Regnault has the following arrangement, which is a modification of his fixed barometer (fig. 132). In the same cistern dips a second tube *a*, of the same diameter, open at both ends, and provided at the top with a three-way cock, one of which is connected with an air pump and the other with the space to be exhausted. The farther the exhaustion is carried the higher the mercury rises in the tube *a*. The differences of level in the tubes *b* and *a* give the pressures. Hence, by measuring the height *ab*, by means of the cathetometer, the pressure in the space that is being exhausted is accurately given. This apparatus is also called the *differential barometer*.

180. **Aneroid barometer.**—This instrument derives its name from the circumstance that no liquid is used in its construction (*ἀ*, without, *νηρός*,

moist). Fig. 142 represents one of the forms of these instruments, constructed by Mr. Casella; it consists of a cylindrical metal box, exhausted of air, the top of which is made of thin corrugated metal, so elastic that it readily yields to alterations in the pressure of the atmosphere.

When the pressure increases, the top is pressed inwards; when on the contrary it decreases, the elasticity of the lid, aided by a spring, tends to move it in the opposite direction. These motions are transmitted by delicate multiplying levers to an index which moves on a scale. The instrument is graduated empirically by compar-



Fig. 142.

ing its indications under different pressures with those of an ordinary mercurial barometer.

The aneroid has the advantage of being portable, and can be constructed of such delicacy as to indicate the difference in pressure between the height of an ordinary table and the ground. It is hence much used in determining heights in mountain ascents. But it is liable somewhat to get out of order, especially when it has been subjected to great variations of pressure; and its indications must from time to time be compared with those of a standard barometer.

The errors arising from the use of the aneroid are mainly due to the transmission of the motion of the lid by the multiplying arrangement.

Goldschmid of Zurich has devised a form in which the motion of the lid is directly observed.

Like that of other aneroids, the lid of the box *a* (fig. 143), in which the alterations of pressure are determined, is of fine corrugated sheet metal. To it is fixed a horizontal metal strip *b*, on the front end of which is a small square *e*, acting as index. This rises and falls with the movement of the lid, and indicates on a scale *ff*, on the sides of the slit *dd*, alterations in pressure of centimetres. To this strip a second and more delicate one, *c*, is fixed, on the front end of which is also fixed an index *e'*. Before making an observation, the horizontal line of this index is made to coincide with that of *e*; this is effected by means of a micrometer screw *m*, which is raised or lowered by the moveable ring *h*; on the corresponding scale millimetres and tenths of a millimetre are read off. To do this the instrument is provided with a lens not represented in the figure. There is also a small thermometer *t*; from its indications a correction is made for temperatures according to an empirical scale specially constructed for each instrument.

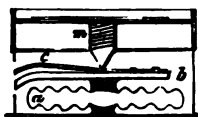

Fig. 143.

181. **Laws of the mixture of gases.**—If a communication is opened between two closed vessels containing gases, they at once begin to mix, whatever be their density, and in a longer or shorter time the mixture is complete, and will continue so, unless chemical action or some other extraneous cause intervene. The laws which govern the mixture of gases may be thus stated :

I. *The mixture takes place rapidly and is homogeneous, that is, each portion of the mixture contains the two gases in the same proportion.*

II. *If the gases severally and the mixture have the same temperature, and if the gases severally and the mixture occupy the same volume, then the pressure on the unit of area exerted by the mixture will equal the sum of pressures on the unit of area exerted by the gases severally.*

From the second law a very convenient formula can be easily deduced.

Let  $v_1, v_2, v_3 \dots$  be the volumes of several gases under pressure of  $p_1, p_2, p_3 \dots$  respectively. Suppose these gases when mixed to have a volume  $V$ , under a pressure  $P$ , the temperatures being the same. By Boyle's law we know that  $v_1$  will occupy a volume  $V$  under a pressure  $p_1'$  provided that

$$\begin{aligned} V p_1' &= v_1 p_1 \\ V p_2' &= v_2 p_2 \end{aligned}$$

Similarly

and so on. But we learn from the above law that

$$\begin{aligned} P &= p_1' + p_2' + \dots \\ VP &= v_1 p_1 + v_2 p_2 + v_3 p_3 + \dots \end{aligned}$$

therefore

It obviously follows that if the pressures are all the same, the volume of the mixture equals the sum of the separate volumes.



The first law was shown experimentally by Berthollet, by means of an apparatus represented in fig. 144. It consists of two glass globes provided with stopcocks, which can be screwed one on the other. The upper globe was filled with hydrogen, and the lower one with carbonic acid, which has 22 times the density of hydrogen. The globes having been fixed together were placed in the cellars of the Paris Observatory and the stopcocks then opened, the globe containing hydrogen being uppermost. Berthollet found after some time that the pressure had not changed, and that, in spite of the difference in density, the two gases had become uniformly mixed in the two globes. Experiments made in the same manner with other gases gave the same results, and it was found that the diffusion was more rapid in proportion as the difference between the densities was greater.

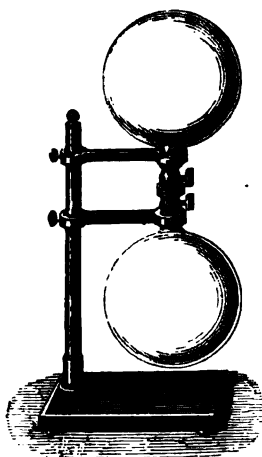

Fig. 144.

The second law may be demonstrated by passing into a graduated tube, over mercury, known volumes of gas at known pressures. The pressure and volume of the whole mixture

are then measured, and found to be in accordance with the law.

Gaseous mixtures follow Boyle's law, like simple gases, as has been proved for air (173), which is a mixture of nitrogen and oxygen.

182. **Mixture of gases and liquids. Absorption.**—Water and many liquids possess the property of absorbing gases. Under the same conditions of pressure and temperature a liquid does not absorb equal quantities of different gases. At the ordinary temperature and pressure water dissolves  $\frac{25}{1000}$  its volume of nitrogen,  $\frac{46}{1000}$  its volume of oxygen, its own volume of carbonic acid, and 430 times its volume of ammoniacal gas.

The whole subject of gas absorption has been investigated by Bunsen. The general laws are the following:—

I. *For the same gas, the same liquid, and the same temperature, the weight of gas absorbed is proportional to the pressure.* This may also be expressed by saying that at all pressures the volume dissolved is the same; or that the density of the gas absorbed is in a constant relation with that of the external gas which is not absorbed.

Accordingly, when the pressure diminishes, the quantity of dissolved gas decreases. If a solution of gas be placed under the air-pump and a vacuum created, the gas obeys its expansive force and escapes with effervescence.

II. *The quantity of gas absorbed is greater when the temperature is lower; that is to say, when the elastic force of the gas is less.*

III. *The quantity of gas which a liquid can dissolve is independent of the nature and of the quantity of other gases which it may already hold in solution.*

In every gaseous mixture each gas exercises the same pressure as it would if its volume occupied the whole space; and the total pressure is

equal to the sum of the individual pressures. When a liquid is in contact with a gaseous mixture, it absorbs a certain part of each gas, but less than it would if the whole space were occupied by each gas. The quantity of each gas dissolved is proportional to the pressure which the unabsorbed gas exercises alone. For instance, oxygen forms only about  $\frac{1}{3}$  the quantity of air; and water, under ordinary conditions, absorbs exactly the same quantity of oxygen as it would if the atmosphere were entirely formed of this gas under a pressure equal to  $\frac{1}{3}$  that of the atmosphere.

### CHAPTER III.

#### PRESSURE ON BODIES IN AIR. BALLOONS.

183. **Archimedes' principle applied to gases.**—The pressure exerted by gases on bodies immersed in them is transmitted equally in all directions, as has been shown by the experiment with the Magdeburg hemispheres. It therefore follows that all which has been said about the equilibrium of bodies in liquids applies to bodies in air; they lose a part of their weight equal to that of the air which they displace.

The loss of weight in air is demonstrated by means of the *baroscope*, which consists of a scalebeam, at one of whose extremities a small leaden weight is supported, and at the other there is a hollow copper sphere (fig. 145). In the air they exactly balance one another; but when they are placed under the receiver of the air-pump and a vacuum is produced, the sphere sinks; thereby showing that in reality it is heavier than the small leaden weight. Before the air is exhausted each body is buoyed up by the weight of the air which it displaces. But as the sphere is much the larger of the two, its weight undergoes most apparent diminution, and thus, though in reality the heavier body, it is balanced by the small leaden weight. It may be proved by means of the same apparatus that this loss is equal to the weight of the displaced air. Suppose the volume of the sphere is 10 cubic inches. The weight of this volume of air is 3.1 grains. If now this weight be added to the leaden weight, it will overbalance the sphere in air, but will exactly balance it in vacuo.



Fig. 145.

The principle of Archimedes is true for bodies in air; all that has been said about bodies immersed in liquids applies to them, that is, that when a body is heavier than air, it will sink, owing to the excess of its weight over

the buoyancy. If it is as heavy as air, its weight will exactly counterbalance the buoyancy, and the body will float in the atmosphere. If the body is lighter than air, the buoyancy of the air will prevail, and the body will rise in the atmosphere until it reaches a layer of the same density as its own. The force of the ascent is equal to the excess of the buoyancy over the weight of the body. This is the reason why smoke, vapours, clouds, and air balloons rise in the air.

#### AIR BALLOONS.

184. **Air balloons.**—*Air balloons* are hollow spheres made of some light impermeable material, which, when filled with heated air, with hydrogen gas, or with coal gas, rise in the air by virtue of their relative lightness.

They were invented by the brothers Mongolfier, of Annonay, and the first experiment was made at that place in June 1783. Their balloon was a sphere of forty yards in circumference, and weighed 500 pounds. At the lower part there was an aperture, and a sort of boat was suspended, in which fire was lighted to heat the internal air. The balloon rose to a height of 2,200 yards, and then descended without any accident.

Charles, a professor of physics in Paris, substituted hydrogen for hot air. He himself ascended in a balloon of this kind in December 1783. The use of hot air balloons was entirely given up in consequence of the serious accidents to which they were liable.

Since then, the art of ballooning has been greatly extended, and many ascents have been made. That which Gay-Lussac made in 1804 was the most remarkable for the facts with which it has enriched science, and for the height which he attained—23,000 feet above the sea level. At this height the barometer descended to 12·6 inches, and the thermometer which was 31° C. on the ground was 9 degrees below zero.

In these high regions, the dryness was such on the day of Gay-Lussac's ascent, that hygrometric substances, such as paper, parchment, etc., became dried and crumpled as if they had been placed near the fire. The respiration and circulation of the blood were accelerated in consequence of the great rarefaction of the air. Gay-Lussac's pulse made 120 pulsations in a minute instead of 66, the normal number. At this great height the sky had a very dark blue tint, and an absolute silence prevailed.

One of the most remarkable of recent ascents was made by Mr. Glaisher and Mr. Coxwell, in a large balloon belonging to the latter. This was filled with 90,000 cubic feet of coal gas (sp. gr. 0·37 to 0·33); the weight of the load was 600 pounds. The ascent took place at 1 P.M. on September 5, 1861; at 1.28 they had reached a height of 15,750 feet, and in eleven minutes after a height of 21,000 feet, the temperature being  $-10\cdot4^{\circ}$ ; at 1.50 they were at 26,200 feet, with the thermometer at  $-15\cdot2^{\circ}$ . At 1.52 the height attained was 29,000 feet, and the temperature  $-16^{\circ}$  C. At this height the rarefaction of the air was so great, and the cold so intense, that Mr. Glaisher fainted, and could no longer observe. According to an approximate estimation the lowest barometric height they attained was 7 inches, which would correspond to an elevation of 36,000 to 37,000 feet.

185. **Construction and management of balloons.**—A balloon is made of long bands of silk sewed together and covered with caoutchouc varnish,

which renders it air-tight. At the top there is a safety valve closed by a spring which the aëronaut can open at pleasure by means of a cord. A light wicker-work boat is suspended by means of cords to a net-work, which entirely covers the balloon.

A balloon of the ordinary dimensions, which can carry three persons, is about 16 yards high, 12 yards in diameter, and its volume, when it is quite full, is about 680 cubic yards. The balloon itself weighs 200 pounds; the accessories, such as the rope and boat, 100 pounds.

The balloon is filled either with hydrogen or with coal gas. Although the latter is heavier than the former, it is generally preferred, because it is cheaper and more easily obtained. It is passed into the balloon from the gas reservoir by means of a flexible tube. It is important not to fill the balloon quite full, for the atmospheric pressure diminishes as it rises (fig. 146), and the gas inside, expanding in consequence of its elastic force, tends to burst it. It is sufficient for the ascent if the weight of the displaced air exceeds that of the balloon by 8 or 10 pounds. And this force remains constant so long as the balloon is not quite distended by the dilatation of the air in the interior. If the atmospheric pressure, for example, has diminished to one-half, the gas in the balloon, according to Boyle's law, has doubled its volume. The volume of the air displaced is therefore twice as great; but since its density has become only one-half, the weight, and consequently the upward buoyancy, are the same. When once the balloon is completely dilated, if it continues to rise, the force of the ascent decreases, for the volume of the displaced air remains the same, but its density diminishes, and a time arrives at which the buoyancy is equal to the weight of the balloon. The balloon can now only take a horizontal direction, carried by the currents of air which prevail in the atmosphere. The aëronaut knows by the barometer whether he is ascending or descending; and by the same means he determines the height which he has reached. A long flag fixed to the boat would indicate, by the position it takes either above or below, whether the balloon is descending or ascending.

When the aëronaut wishes to descend, he opens the valve at the top of

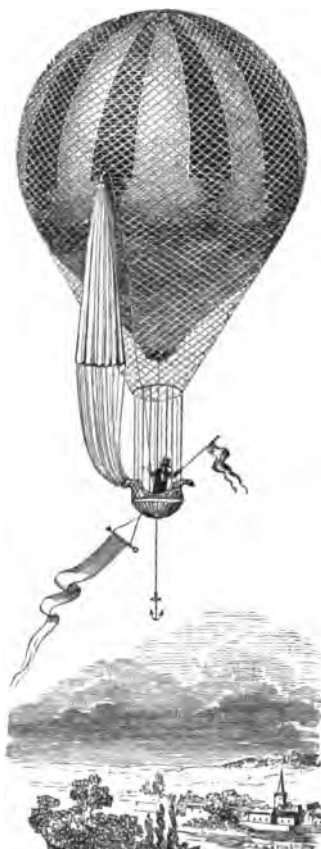

Fig. 146.

the balloon by means of the cord, which allows gas to escape, and the balloon sinks. If he wants to descend more slowly, or to rise again, he empties out bags of sand, of which there is an ample supply in the car. The descent is facilitated by means of a grappling iron fixed to the boat. When once this is fixed to any obstacle, the balloon is lowered by pulling the cord.

The only practical applications which air balloons have hitherto had have been in military reconnoitring. At the battle of Fleurus, in 1794, a

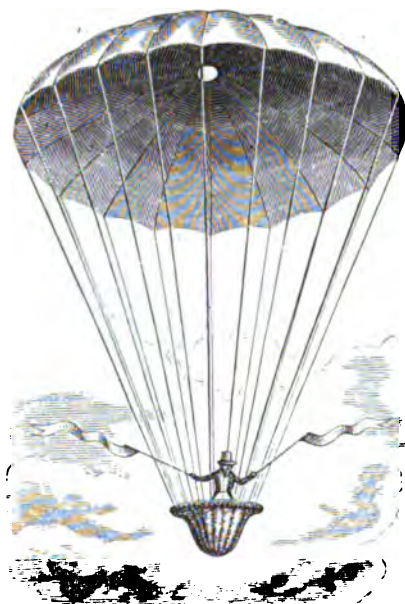

Fig. 147.

captive balloon, that is, one held by a cord, was used, in which there was an observer who reported the movements of the enemy by means of signals. At the battle of Solferino the movements and dispositions of the Austrian troops were watched by a captive balloon; and in the war in America balloons were frequently used, while their importance during the siege of Paris is fresh in all memories. The whole subject of military ballooning has been treated in two papers by Captain Grover and by Captain Beaumont, in a recent volume of the Professional Papers of the Royal Engineers. It has been proposed to use captive balloons for observations on the changes of temperature in the air, etc. Air balloons can only be truly useful when they can be guided, and as yet all attempts made with this view have completely failed. There is no other course at present than to rise in the

air until there is a current which has more or less the desired direction.

186. **Parachute.**—The object of the parachute is to allow the aëronaut to leave the balloon, by giving him the means of lessening the rapidity of his descent. It consists of a large circular piece of cloth (fig. 147) about 16 feet in diameter, and which by the resistance of the air spreads out like a gigantic umbrella. In the centre there is an aperture, through which the air compressed by the rapidity of the descent makes its escape; for otherwise oscillations might be produced, which, when communicated to the boat, would be dangerous.

In fig. 146 there is a parachute attached to the net-work of the balloon by means of a cord which passes round a pulley, and is fixed at the other end to the boat. When the cord is cut the parachute sinks, at first very rapidly, but more slowly as it becomes distended, as represented in the figure.

187. **Calculation of the weight which a balloon can raise.**—To calculate the weight which can be raised by a balloon of given dimensions

let us suppose it perfectly spherical, and premise that the formulæ which express the volume and the superficies in terms of the radius are  $V = \frac{4\pi R^3}{3}$ ,  $S = 4\pi R^2$ ;  $\pi$  being the ratio of the circumference to the diameter. The radius  $R$  being measured in feet, let  $\rho$  be, in pounds, the weight of a square foot of the material of which the balloon is constructed; let  $P$  be the weight of the car and the accessories,  $a$  the weight in pounds of a cubic foot of air at zero, and under the pressure  $0.76^m$ , and  $a'$  the weight of the same volume, under the same conditions, of the gas with which the balloon is inflated (149). Then the total weight of the envelope in pounds will be  $4\pi R^2 \rho$ ; that of the gas will be  $\frac{4\pi R^3 a'}{3}$ , and that of the displaced air  $\frac{4\pi R^3 a}{3}$ . If  $X$  be the weight which the balloon can support, we have

$$X = \frac{4\pi R^3 a}{3} - \frac{4\pi R^3 a'}{3} - 4\pi R^2 \rho - P.$$

Whence

$$X = \frac{4\pi R^3}{3}(a - a') - 4\pi R^2 \rho - P.$$

But, as we have before seen (185), in order that the balloon may rise, the weights must be less by 8 or 10 pounds than that given by this equation.

## CHAPTER IV.

### APPARATUS FOUNDED ON THE PROPERTIES OF AIR.

188. **Air-pump.**—The air-pump is an instrument by which a vacuum can be produced in a given space, or rather by which air can be greatly rarefied, for an absolute vacuum cannot be produced by its means. It was invented by Otto von Guericke in 1650, a few years after the invention of the barometer.

The air-pump, as now usually constructed, may be described as follows: In fig. 148, which shows the general arrangement,  $E$  is the receiver, in which the vacuum is to be produced. It is a bell glass resting on a plate  $D$ , of thick glass ground perfectly smooth. In the centre of  $D$ , at  $C$ , there is an opening by which a communication is made between the interior of the receiver and of the cylinders  $P, P$ . This communication is effected by a tube or pipe passing through the body of the plate  $A$ , and then branching off at right angles, as shown by  $Kco Kcs$ , in fig. 149, which represents a horizontal section of the machine. In the cylinders—which are commonly of glass, and which are firmly cemented to the plate  $A$ —are two pistons,  $P$  and  $Q$ , fitting air-tight. Each piston is moved by a rack, working with a pinion,  $H$ , turned by a handle,  $M$ . This is shown more plainly in fig. 150, which represents a vertical section of the machine through the cylinders; here  $H$  is the pinion, and  $MN$  the handle. When  $M$  is forced down one piston is

raised, and the other depressed. When M's action is reversed, the former piston is depressed, and the latter raised.

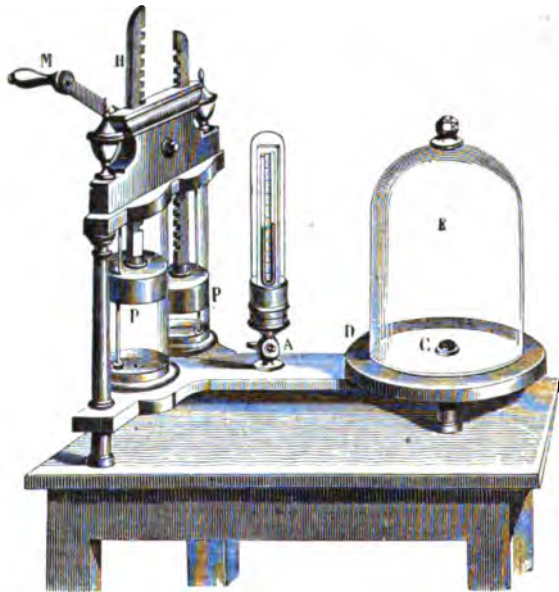

Fig. 148.

The action of the machine is this : Each cylinder is fitted with a valve so contrived that when its piston is raised, communication is opened

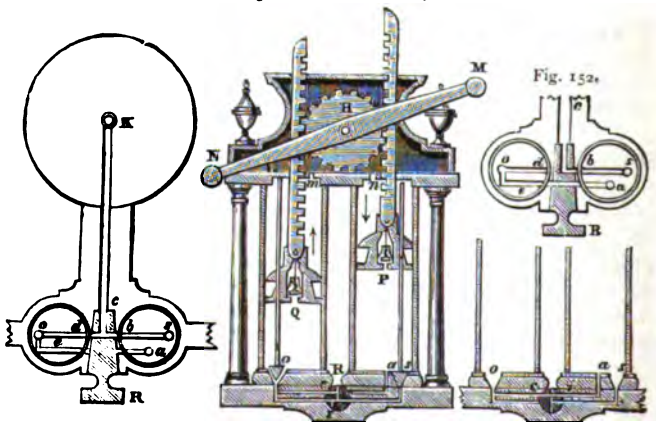

Fig. 149.

Fig. 150.

Fig. 151.

between the cylinder and the receiver : when it is depressed the communication is closed. Now if P were simply raised, a vacuum would be formed

below P ; but as a communication is opened with the receiver E, the air in E expands so as to fill both the receiver and the cylinder. As soon as the piston begins to descend, the communication is closed, and none of the air in the cylinder returns to the receiver, but, by means of properly constructed valves, escapes into the atmosphere. Consequently the rarefaction which the air in the receiver has undergone is permanent. By the next stroke a further rarefaction is produced : and so on, at each succeeding stroke.

It is plain that when the rarefaction has proceeded to a considerable extent the atmospheric pressure on the top of P will be very great, but it will be very nearly balanced by the atmospheric pressure on the top of the other piston. Consequently the experimenter will have to overcome only the difference of the two pressures. This is the reason why two cylinders are employed.

To explain the action of the valves we must go into particulars. The general arrangement of the interior of the cylinders is shown in fig. 150.

Fig. 153 shows the section of the piston in detail. The piston is formed of two brass discs (X and V), screwed to one another, and compressing between them a series of leather discs Z, whose diameters are slightly greater than those of the brass discs. The leather is thoroughly saturated with oil, so as to slide air-tight, though with but little friction, within the cylinder. To the centre of the upper disc is screwed a piece, B, to which the rack H is riveted. The piece B is pierced so as to put the interior of the cylinder into communication with the external air. This communication is closed by a valve *t*, held down by a delicate spring, *r*. When the piston is moved downward the air below the piston is compressed until it forces up *t* and escapes. The instant the action is reversed, the valve *t* falls, and is held down by the spring, and by the pressure of the external air, which is thereby kept from coming in. The communication between the cylinder below the piston and the receiver is opened and closed by the valve marked *o* in fig. 150, and *sg* in fig. 153. The rod *sg* passing through the piston is held by friction, and is raised with it ; but is kept from being lifted through more than a very small distance by the top of the cylinder, while the piston, in continuing its upward motion, slides over *sg*. When the piston descends it brings the valve with it, which at once cuts off the communication between the cylinder and the receiver.

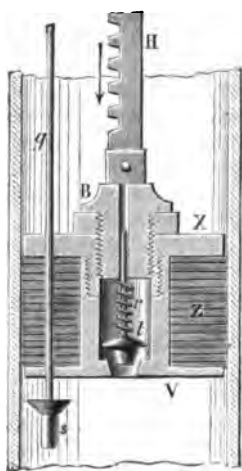

Fig. 153.

189. **Air-pump gauge.**—When the pump has been worked some time, the pressure in the receiver is indicated by the difference of level of the mercury in the two legs of a glass tube bent like a syphon, one of which is opened, and the other closed like the barometer. This little apparatus, which is called the *gauge*, is fixed to an upright scale, and placed under



a small bell jar, which communicates with the receiver E by a stop-cock, A, inserted in the tube leading from the orifice C to the cylinders, fig. 148.

Before commencing to exhaust the air in the receiver, its elastic force exceeds the weight of the column of mercury, which is in the closed branch and which consequently remains full. But as the pump is worked, the elastic force soon diminishes, and is unable to support the weight of the mercury which sinks and tends to stand at the same level in both legs. If an absolute vacuum could be produced, they would be exactly on the same level, for there would be no pressure either on the one side or the other. But with the very best machines the level is always about a thirtieth of an inch higher in the closed branch, which indicates that the vacuum is not absolute, for the elastic force of the residue is equal to the pressure of a column of mercury of that height.

Theoretically an absolute vacuum is impossible; for, since the volume of each cylinder is, say,  $\frac{1}{20}$  that of the receiver, only  $\frac{1}{21}$  of the air in the receiver is extracted at each stroke of the piston, and consequently it is impossible to exhaust all the air which it contains. The theoretical degree of exhaustion after a given number of strokes is easily calculated as follows:—Let A denote the volume of the receiver, including in that term the pipe; B the volume of the cylinder between the highest and lowest positions of the piston; and assume for the sake of distinctness that there is only one cylinder; then the air which occupied A before the piston is lifted occupies A + B after it is lifted, and consequently if  $D_1$  is the density at the end of the first stroke and D the original density, we must have

$$D_1 = D \frac{A}{A + B}$$

If  $D_2$  is the density at the end of the second stroke, we have for just the same reason

$$D_2 = D_1 \frac{A}{A + B} = D \left( \frac{A}{A + B} \right)^2$$

Now this reasoning will apply to  $n$  strokes;

consequently

$$D_n = D \left( \frac{A}{A + B} \right)^n$$

If there are two equal cylinders, the same formula holds, but in this case, in counting  $n$ , upstrokes and downstrokes equally reckon as *one*.

It is obvious that the exhaustion is never complete, since D can be zero only when  $n$  is infinite. However, no very great number of strokes is required to render the exhaustion virtually complete even if A is several times greater than B. Thus if  $A = 10 B$ , a hundred strokes will reduce the density from D to 0.0004 D; that is, if the initial pressure is 30 in., the pressure at the end of 100 strokes is 0.012 of an inch.

Practically, however, a limit is placed on the rarefaction that can be produced by any given air-pump; for, as we have seen, the air becomes ultimately so rarefied that, when the pistons are at the bottom of the cylinder, its elastic force cannot overcome the pressure on the valves in the inside of

the piston; they therefore do not open, and there is no further action of the pump.

**190. Doubly-exhausting stopcock.**—Babinet invented an improved stopcock, by which the exhaustion of the air can be carried to a very high degree. This stopcock is placed in the fork of the pipe leading from the receiver to the two cylinders; it is perforated by several channels, which are successively used by turning it into two different positions. Fig. 149 represents a horizontal section of the stopcock R, in such a position that, by its central opening and two lateral openings, it forms a communication between the orifice K of the plate, and the two valves *o* and *s*. The machine then works as has been described. In fig. 152 the stopcock has been turned a quarter, and the transversal channel *db*, which was horizontal in fig. 149, is now vertical, and its extremities are closed by the side of the hole in which the stopcock works. But a second channel, which was closed before, and which has taken the place of the first, now places the right cylinder *alone* in communication with the receiver by the channel *cbz* (fig. 150), and it further connects the right with the left cylinder by a channel *aeo* (fig. 153), or *aico* (fig. 151). This channel passes from a central opening *a*, placed at the base of the right cylinder, across the stopcock to the valve *o*, of the other cylinder, as represented in figs. 151 and 152: but this channel is closed by the stopcock when it is in its first position, as is seen in figs. 149 and 150.

The right piston in rising exhausts the air of the receiver, but when it descends the exhausted air is driven into the left cylinder through the orifice *a*, the channel *io*, and the valve *o* (fig. 151), which is open. When the same piston rises, that of the left sinks; but the air which is above it does not return into the right cylinder, because the valve *o* is now closed. As the right cylinder continues to exhaust the air in the receiver, and to force it into the left cylinder, the air accumulates here, and ultimately acquires sufficient tension to raise the valve of the piston Q, which was impossible before the stopcock was turned, for it is only when the valves in the piston no longer open, that a quarter of a turn is given to the stopcock.

**191. Bianchi's air-pump.**—M. Bianchi invented an air-pump which has several advantages. It is made entirely of iron, and it has only one cylinder, which oscillates on a horizontal axis fixed at its base as seen in fig. 154. A horizontal shaft, with heavy fly-wheel, V, works in a frame, and is turned by a handle, M. A crank, *m*, which is joined to the top of the piston-rod, is fixed to the same shaft, and consequently at every revolution of the wheel the cylinder makes two oscillations.

In some cases, as in that shown in the figure, the crank and the fly-wheel are on parallel axes connected by a pair of cog-wheels. The modification in the action produced by this arrangement is as follows:—If the cog-wheel on the former axis has twice as many teeth as that on the latter axis, the pressure which raises the piston is doubled; an advantage which is counterbalanced by the inconvenience that now the piston will make one oscillation for one revolution of the fly-wheel.

The machine is doubly acting; that is, the piston PP (fig. 155) produces a vacuum both in ascending and descending. This is effected by the following

arrangements :—In the piston there is a valve, *b*, opening upwards as in the ordinary machine. The piston rod AA is hollow, and in the inside there is a copper tube, X, by which the air makes its escape through the valve *b*. At the top of the cylinder there is a second valve, *a*, opening upwards.

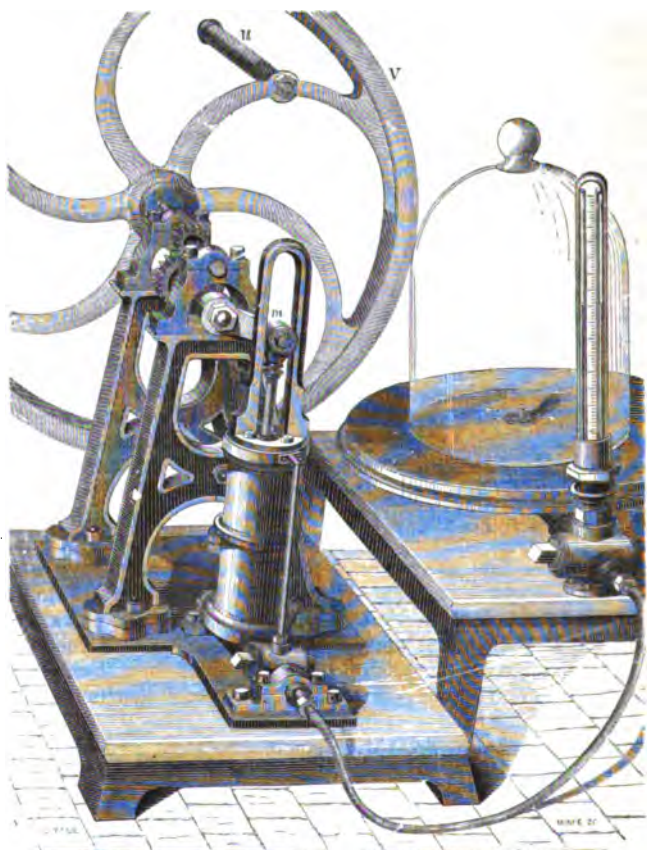

Fig. 154.

An iron rod, D, works with gentle friction in the piston, and terminates at its ends in two conical valves, *s* and *s'*, which fit into the openings of the tube BC leading to the receiver.

Let us suppose the piston descends. The valve *s'* is then closed, and the valve *s* being open, the air of the receiver passes in the space above the piston, while the air in the space below the piston undergoes compression, and, raising the valve, escapes by the tube X, which communicates with the atmosphere. When the piston ascends, the exhaustion takes place through *s'*, and the valve *s* being closed, the compressed air escapes by the valve *a*.

The machine has a stopcock for double exhaustion, similar to that already

described (190). It is also oiled in an ingenious manner. A cup, E, round the rod is filled with oil, which passes into the annular space between the rod AA and the tube X; it passes then into a tube *oo*, in the piston, and, forced by the atmospheric pressure, is uniformly distributed on the surface of the piston.

The apparatus, being of iron, may be made of much greater dimensions than the ordinary air-pump. A vacuum can also be produced with it in far less time and in apparatus of greater size than usual.

192. **Delcull's air-pump.**—In this air-pump the main peculiarity is its piston, which is of considerable length and consists of a series of accurately constructed metal discs bolted together. This works easily and smoothly in the barrel, and no packing or lubricator is used; or rather the lubricator is the air in the space between the piston and the barrel. The internal friction of the air in this narrow space is so great that the rate at which it leaks into the barrel is far inferior to the rate at which the pump is exhausting air from the receiver. And Clerk Maxwell has shown that the internal friction is not diminished even when its density is greatly reduced. Hence the pump works very satisfactorily up to a considerable degree of exhaustion—to a millimetre of mercury, for instance.

193. **Sprenzel's air-pump.**—Sprenzel has devised a form of air-pump which depends on the principle of converting the space to be exhausted into a Torricellian vacuum.

If an aperture be made in the top of a barometer tube, the mercury sinks and draws in air; if the experiment be so arranged as to allow air to enter along with mercury and if the supply of air be limited while that of mercury is unlimited, the air will be carried away, and a vacuum produced. The following is the simplest form of the apparatus in which this action is realised. In fig. 156 *cd* is a glass tube longer than a barometer, open at both ends, and connected by means of indiarubber tubing with a funnel, A, filled with mercury and supported by a stand. Mercury is allowed to fall in this tube at a rate regulated by a clamp at *c*; the lower end of the tube *cd* fits in the flask B, which has a spout at the side a little higher than the lower

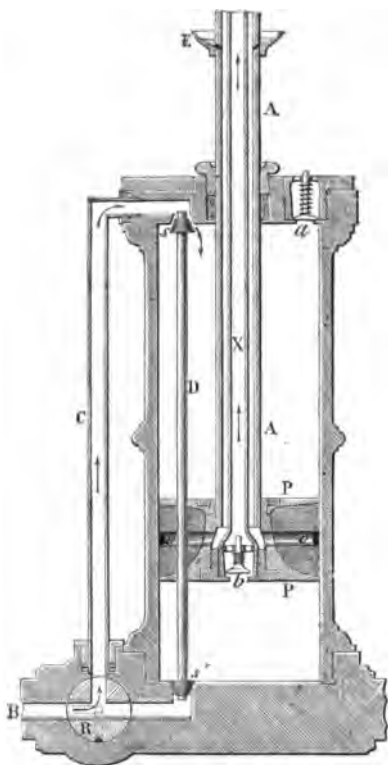

Fig. 155.

end of *cd*; the upper part has a branch at *x* to which a receiver R can be tightly fixed. When the clamp at *c* is opened, the first portions of mercury

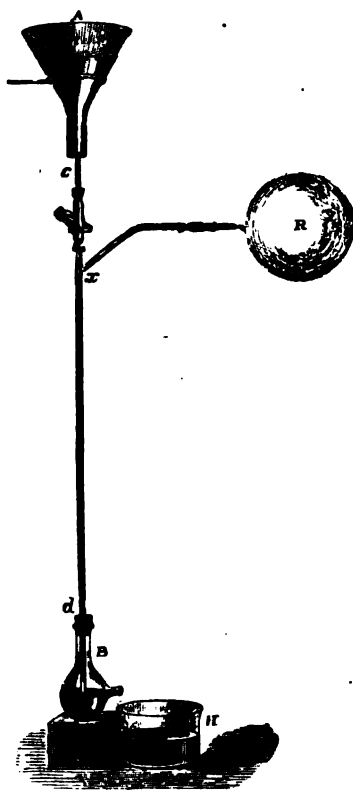

Fig. 156.

which run out close the tube and prevent air from entering below. As the mercury is allowed to run down, the exhaustion begins, and the whole length of the tube from *x* to *d* is filled with cylinders of air and mercury having a downward motion. Air and mercury escape through the spout of the bulb B which is above the basin A, where the mercury is collected. It is poured back from time to time into the funnel A, to be repassed through the tube until the exhaustion is complete. As this point is approached, the enclosed air between the mercury cylinders is seen to diminish, until the lower part of *cd* forms a continuous column of mercury about 30 inches high. Towards this stage of the process a noise is heard like that of a water-hammer when shaken; the operation is completed when the column of mercury encloses no air and a drop of mercury falls on the top of the column without enclosing the slightest air bubble. The height of the column then represents the height of the column of mercury in the barometer; in other words it is a barometer whose Torricellian vacuum is the receiver R. This apparatus has been used with great success in experiments in which a very complete exhaustion is required, as in the preparation of Geissler's

tubes. (See Book X. Chapter VI.) It may be advantageously combined with an exhausting syringe, which first removes the greater part of the air, the exhaustion being then completed as above.

The most perfect vacua are obtained by absorbing the residual gas, after the exhaustion has been pushed as far as possible, either mechanically, or by some substance with which it combines chemically. Thus Dewar has produced a vacuum which he estimates at  $\frac{1}{350}$  of a millimetre by heating charcoal to redness, in a vessel from which air had been exhausted by the Sprengel's pump, and then allowing it to cool. Finkiner filled a vessel with oxygen, then exhausted as far as possible, and finally heated to redness some copper contained in the vessel. This absorbed the minute quantity of gas left, with the formation of cupric oxide. In some recent experiments Crookes has obtained a vacuum of  $\frac{1}{13000}$  of a millimetre.

194. **Aspirating action of currents of air.**—When a jet of liquid or of a gas passes through air it carries the surrounding air along with it; fresh air rushes in to supply its place, comes also in contact with the jet, and is in like manner carried away. Thus then there is a continual rarefaction of the air around the jet, in consequence of which it exerts an aspiratory action.

This phenomenon may be well illustrated by means of an apparatus represented in fig. 157, the analogy of which to the experiment described (211) will be at once evident. It consists of a wide glass tube in the two ends of which are fitted two small tubes *nd* and B; in the bottom is a manometer tube containing a coloured liquid. On blowing through the narrow tube the liquid at *o* is seen to rise. If on the contrary the wide tube be blown into, a depression is produced at *o*.

To this class of phenomena belongs the following experiment, which is a simple modification of one originally described by Clement and Desormes. Holding one hand horizontal, the palm downwards and the fingers closed, you blow through the space between the index and middle finger. If a piece of light paper, of 2 or 3 square inches, is held against the aperture it does not fall as long as the blowing continues.

The old *water bellows* still used in mountainous places where there is a continuous fall is a further application of the principle. Water falling from a reservoir down a narrow tube divides and carries air along with it; and if there are apertures in the side through which air can enter, this also is carried along, and becomes accumulated in a reservoir placed below, from which by means of a lateral tube it can be directed into the hearth of a forge.

By the *locomotive steam-pipe* a jet of steam entering the chimney of the locomotive carries the air away, so that fresh air must arrive through the fire and thus the draught be kept up. In *Giffard's injector* water is pumped by means of a jet of steam into the boiler of a steam-engine.

195. **Morren's mercury pump.**—Figs. 158 and 159 represent a mercurial air-pump, which is an improvement by Alvergriat, of a form devised by Morren.

It consists of two reservoirs, A and B, figs. 158 and 159, connected by a barometer tube T, and a long caoutchouc tube C. The reservoir B and the tube T are fixed to a vertical support A, which is moveable and open, and can be alternately raised and lowered through a distance of nearly four feet. This is effected by means of a long wire rope, which is fixed at one end to the reservoir A, and passes over two pulleys, *a* and *b*, the latter of which is turned by a handle. Above the reservoir B is a three-way cock *n*; to this is attached a tube *d*, for exhaustion, and on the left is an ordinary stopcock *m*, which communicates with a reservoir of mercury *v*, and with the air. The exhausting tube *d* is not in direct communication with the receiver to be exhausted; it is first connected with a reservoir *o*, partially filled with sulphuric acid, and designed to dry the gases which enter the apparatus. A caout-

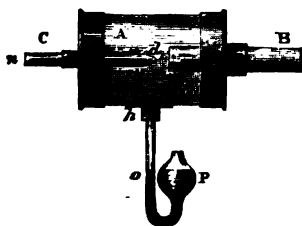

Fig. 157.

chouc tube, *c*, makes communication with the receiver which is to be exhausted. On the reservoir *o* is a small mercury manometer *p*.

These details being understood, suppose the reservoir *A* at the top of its course (fig. 158), the stopcock *m* open, and the stopcock *n* turned as seen in *Z*; the caoutchouc tube *C*, the tube *T*, the reservoir *B*, and the tube above are filled with mercury as far as *v*; closing then the stopcock *m*, and lowering the reservoir *A* (fig. 161), the mercury sinks in the reservoir *B*, and in the tube *T*, until the difference of levels in the two tubes is equal to the barometric height, and there is a vacuum in the reservoir *B*. Turning now the stopcock *n*, as shown in figure *X*, the gas from the space to be exhausted

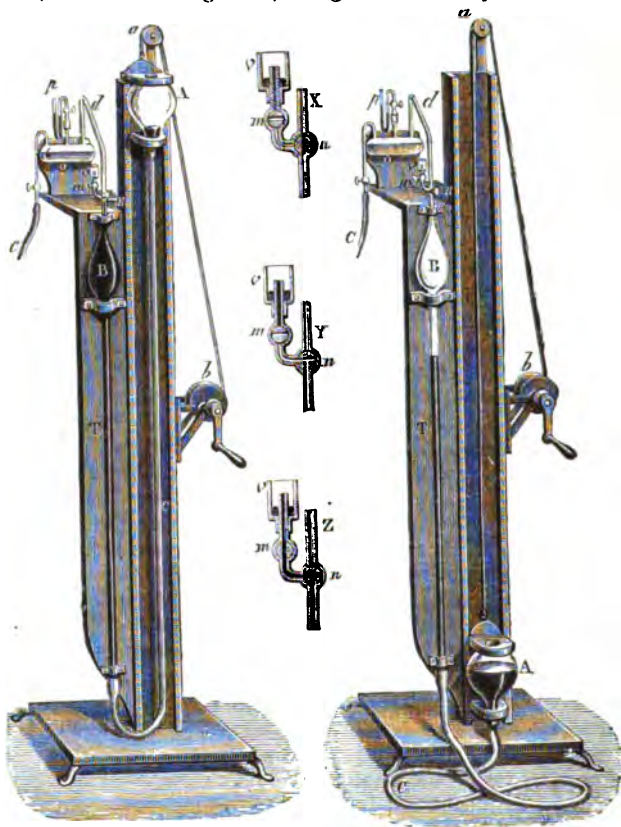

Fig. 158.

Fig. 159.

passes into the barometric chamber *B*, by the tubes *c* and *d*, and the level again sinks in the tube *T*. The stopcocks are now replaced in the first position (fig. *Z*), and the reservoir *A* is again lifted, the excess of pressure of mercury in the caoutchouc tube expels through the stopcocks, *n* and *m*, the gas which had passed into the chamber *B*, and if a few droplets of mercury

are carried along with them they are collected in the vessel *v*. The process is repeated until the mercury is virtually at the same level in both legs.

Like Sprengel's pump, this is very slow in its working, and, like it, is best employed in completing the exhaustion of a space which has already been partially rarefied; for a vacuum of  $\frac{1}{10}$ th of a millimetre may be obtained by its means.

196. **Condensing pump.**—The condensing pump is an apparatus for compressing air, or any other gas. The form usually adopted is the following: In a cylinder, *A*, of small diameter (fig. 161), there is a solid piston, the rod of which is moved by the hand. The cylinder is provided with a screw which fits into the receiver *K*. Fig. 160 shows the arrangement of the valves, which are so constructed that the lateral valve *o* opens from the outside, and the lower valve *s* from the inside.

When the piston descends, the valve *o* closes, and the elastic force of the compressed air opens the valve *s*, which thus allows the compressed air to pass into the receiver. When the piston ascends, *s* closes and *o* opens, and permits the entrance of fresh air, which in turn becomes compressed by the descent of the piston, and so on.

This apparatus is chiefly used for charging liquids with gases. For this purpose the stopcock *B* is connected with a reservoir of the gas, by means of the tube *D*. The pump exhausts this gas, and forces it into the vessel *K*, in which the liquid is contained. The artificial gaseous waters are made by means of analogous apparatus.

197. **Uses of the air-pump.**—A great many experiments with the air-pump have been already described. Such are the mercurial rain (13), the fall of bodies in vacuo (77), the bladder (147), the bursting of a bladder (153) the Magdeburg hemispheres (154), and the baroscope (183).

The fountain in vacuo (fig. 162) is an experiment made with the air-pump, and shows the elastic force of the air. It consists of a glass vessel, *A*, provided at the bottom with a stopcock, and a tubulure which projects into the interior. Having screwed this apparatus to the air-pump it is exhausted, and, the stopcock being closed, it is placed in a vessel of water, *R*. Opening then the stopcock, the atmospheric pressure upon the water in the vessel makes it jet through the tubulure into the interior of the vessel, as shown in the drawing.

Fig. 163 represents an experiment illustrating the effect of atmospheric pressure on the human body. A glass vessel, open at both ends, being placed

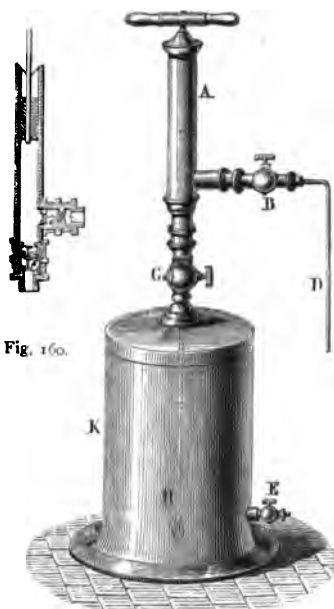

Fig. 160.

Fig. 161.



on the plate of the machine, the upper end of the cylinder is closed by the hands, and a vacuum is made. The hand then becomes pressed by the weight of the atmosphere, and can only be taken away by a great effort. And as the elasticity of the fluids contained in the organs is not counter-balanced by the weight of the atmosphere, the palm of the hand swells, and blood tends to escape from the pores.

By means of the air-pump it may be shown that air, by reason of the oxygen it contains, is necessary for the support of combustion and of life. For if we place a lighted taper under the receiver, and begin to exhaust the air, the flame becomes weaker as rarefaction proceeds, and is finally extin-



Fig. 162.



Fig. 163.

guished. Similarly an animal faints and dies, if a vacuum is formed in a receiver under which it is placed. Mammalia and birds soon die in vacuo. Fish and reptiles support the loss of air for a much longer time. Insects can live several days in vacuo.

Substances liable to ferment may be kept in vacuo for a long time without alteration, as they are not in contact with oxygen, which is necessary for fermentation. Food kept in hermetically-closed cases, from which the air had been expelled, has been found as fresh after several years as on the first day.

198. **Hero's fountain.**—Hero's fountain, which derives its name from its inventor, Hero, who lived at Alexandria, 120 B.C., depends on the elasticity of the air. It consists of a brass dish, D (fig. 164), and of two glass globes, M and N. The dish communicates with the lower part of the globe N by a long tube, B; and another tube, A, connects the two globes. A third tube passes through the dish D to the lower part of the globe M. This tube having

been taken out, the globe M is partially filled with water, the tube is then replaced, and water is poured into the dish. The water flows through the tube B into the lower globe, and expels the air, which is forced into the upper globe; the air, thus compressed, acts upon the water, and makes it jet out as represented in the figure. If it were not for the resistance of the atmosphere and friction, the liquid would rise to a height above the water in the dish equal to the difference of the level in the two globes.

199. **Intermittent fountain.**—The *intermittent fountain* depends partly on the elastic force of the air and partly on the atmospheric pressure. It consists of a stoppered glass globe (C, fig. 165), provided with two or three

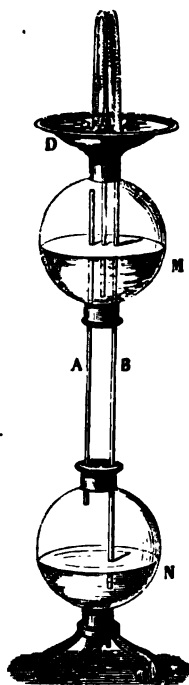

Fig. 164.

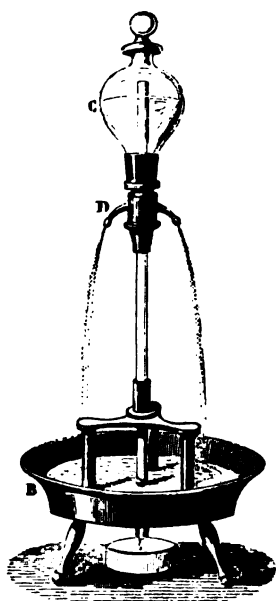

Fig. 165.

capillary tubulures, D. A glass tube open at both ends reaches at one end to the upper part of the globe C; the other end terminates just above a little aperture in the dish B, which supports the whole apparatus.

The water with which the globe C is nearly two-thirds filled, runs out by the tubes D, as shown in the figure; the internal pressure at D being equal to the atmospheric pressure, together with the weight of the column of water CD, while the external pressure at that point is only that of the atmosphere. These conditions prevail so long as the lower end of the glass tube is open, that is, so long as air can enter C and keep the air in C at the same density as the external air; but the apparatus is arranged so that the orifice in the

dish B does not allow so much water to flow out as it receives from the tubes D, in consequence of which the level gradually rises in the dish, and closes the lower end of the glass tube. As the external air cannot now enter the globe C, the air becomes rarefied in proportion as the flow continues, until the pressure of the column of water CD, together with the tension of the air contained in the globe, is equal to this external pressure at D; the flow consequently stops. But as water continues to flow out of the dish B, the tube D becomes open again, air enters, and the flow recommences, and so on, as long as there is water in the globe C.

200. **The syphon.**—The syphon is a bent tube open at both ends, and with unequal legs (fig. 166). It is used in transferring liquids in the following



Fig. 166.

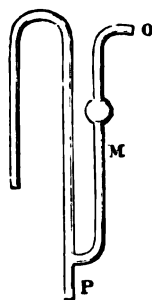

Fig. 167.

manner: The syphon is filled with some liquid, and the two ends being closed, the shorter leg is dipped in the liquid, as represented in fig. 166; or the shorter leg having been dipped in the liquid, the air is exhausted by applying the mouth at B. A vacuum is thus produced, the liquid in C rises and fills the tube in consequence of the atmospheric pressure. It will then run out through the syphon as long as the shorter end dips in the liquid.

A syphon of the form represented in fig. 167 is used where the presence of the liquid in the mouth would be objectionable. A tube, M, is attached to the longer branch, and it is filled by closing the end P, and sucking at O. An enlargement, M, renders the passage of any liquid into the mouth more difficult.

To explain this flow of water from the syphon, let us suppose it filled and the short leg immersed in the liquid. The pressure then acting on C, and tending to raise the liquid in the tube, is the atmospheric pressure minus the height of the column of liquid DC. In like manner, the pressure on the end of the tube, B, is the weight of the atmosphere less the pressure of the column of liquid AB. But as this latter column is longer than CD, the force acting at B is less than the force acting at C, and consequently a flow takes place proportional to the difference between these two forces. The flow will therefore be more rapid in proportion as the difference of level between the aperture B and the surface of the liquid in C is greater.

It follows from the theory of the syphon that it would not work in vacuo, nor if the height CD were greater than that of a column of liquid which counterbalances the atmospheric pressure.

**201. The intermittent syphon.**—In the *intermittent* syphon the flow is not continuous. It is arranged in a vessel, so that the shorter leg is near the bottom of the vessel, while the longer leg passes through it (fig. 168). Being fed by a constant supply of water, the level gradually rises both in the vessel and in the tube to the top of the syphon, which it fills, and water begins to flow out. But the apparatus is arranged so that the flow of the syphon is more rapid than that of the tube which supplies the vessel, and consequently the level sinks in the vessel until the shorter branch no longer dips in the liquid; the syphon is then empty, and the flow ceases. But as the vessel is continually fed from the same source, the level again rises, and the same series of phenomena is reproduced.

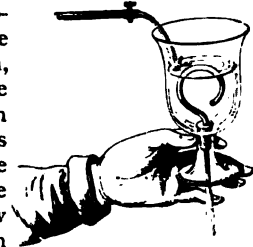

Fig. 168.

The theory of the intermittent syphon explains the natural intermittent springs which are found in many countries, and of which there is an excellent example near Giggleswick in Yorkshire. Many of these springs furnish water for several days or months, and then, after stopping for a certain interval, again recommence. In others the flow stops and recommences several times in an hour.

These phenomena are explained by assuming that there are subterranean mountains, which are more or less slowly filled by springs, and which are then emptied by fissures so occurring in the ground as to form an intermittent syphon.

**202. Different kinds of pumps.**—*Pumps* are machines which serve to raise water either by suction, by pressure, or by both efforts combined; they are consequently divided into *suction or lift pumps*, *force pumps*, and *suction and forcing pumps*.

The various parts entering into the construction of a pump are the barrel, the piston, the valves, and the pipes. The *barrel* is a cylinder of metal or of wood, in which is the *piston*. The latter is a metal or wooden cylinder wrapped with tow, and working with gentle friction the whole length of the barrel.

The valves are discs of metal or leather, which alternately close the apertures which connect the barrel with the pipes. The most usual valves



Fig. 169.



Fig. 170.

are the *clack valve* (fig. 169) and the *conical valve* (fig. 170). The first is a metal disc fixed to a hinge on the edge of the orifice to be closed. In order

more effectually to close it, the lower part of the disc is covered with thick leather. Sometimes the valve consists merely of a leather disc, of larger diameter than the orifice, nailed on the edge of the orifice. Its flexibility enables it to act as a hinge.

The conical valve consists of a metal cone fitting in an aperture of the same shape. Below this is an iron loop, through which passes a bolt-head fixed to the valve. The object of this is to limit the play of the valve when it is raised by the water, and to prevent its removal.

**203. Suction pump.**—Fig. 171 represents a model of a suction pump such as is used in lectures, but which has the same arrangement as the pumps in



FIG. 171.

common use. It consists, 1st, of a *glass cylinder*, B, at the bottom of which there is a valve, S, opening upwards; 2nd, of a *suction tube*, A, which dips into the reservoir from which water is to be raised; 3rd of a *piston*, which is moved up and down by a rod worked by an handle, P. The piston is perforated by a hole; the upper aperture is closed by a valve, O, opening upwards.

When the piston rises from the bottom of the cylinder, a vacuum is produced below, and the valve O is kept closed by the atmospheric pressure, while the air in the pipe A, in consequence of its elasticity, raises the valve S, and partially passes into the cylinder. The air being thus rarefied, water rises in the pipe until the pressure of the liquid column, together with the tension of the rarefied air which remains in the tube, counterbalances the pressure of the atmosphere on the water of the reservoir.

When the piston descends, the valve S closes by its own weight, and prevents the return of the air from the cylinder into the tube A. The air compressed by the piston opens the valve O, and escapes into the atmosphere by the pipe C. With a second stroke of the piston the same series of phenomena is produced, and after a few strokes the water reaches the cylinder. The effect is now somewhat modified; during the descent of the piston, the valve S closes, and the water raises the valve O, and passes above the piston, by which it is lifted into the upper reservoir D. There is now no more air in the pump, and the water forced by the atmospheric pressure, rises with the piston, provided that when it is at the summit of its course it is not more than 34 feet above the level of the water in which the tube A dips, for we have seen (156) that a column of water of this height is equal to the pressure of the atmosphere.

common use. It consists, 1st, of a *glass cylinder*, B, at the bottom of which there is a valve, S, opening upwards; 2nd, of a *suction tube*, A, which dips into the reservoir from which water is to be raised; 3rd of a *piston*, which is moved up and down by a rod worked by an handle, P. The piston is perforated by a hole; the upper aperture is closed by a valve, O, opening upwards.

When the piston rises from the bottom of the cylinder, a vacuum is produced below, and the valve O is kept closed by the atmospheric pressure, while the air in the pipe A, in consequence of its elasticity, raises the valve S, and partially passes into the cylinder. The air being thus rarefied, water rises in the pipe until the pressure of the liquid column, together with the tension of the rarefied air which remains in the tube, counterbalances the pressure of the atmosphere on the water of the reservoir.

When the piston descends, the valve S closes by its own weight, and

In practice the height of the tube A does not exceed 26 to 28 feet, for, although the atmospheric pressure can support a higher column, the vacuum produced in the barrel is not perfect, owing to the fact that the piston does not fit exactly on the bottom of the barrel. But when the water has passed the piston, it is the ascending force of the latter which raises it, and the height to which it can be brought depends on the force which moves the piston.

204. **Suction and force pump.**—The action of this pump, a model of which is represented in fig. 172, depends both on exhaustion and on pressure.

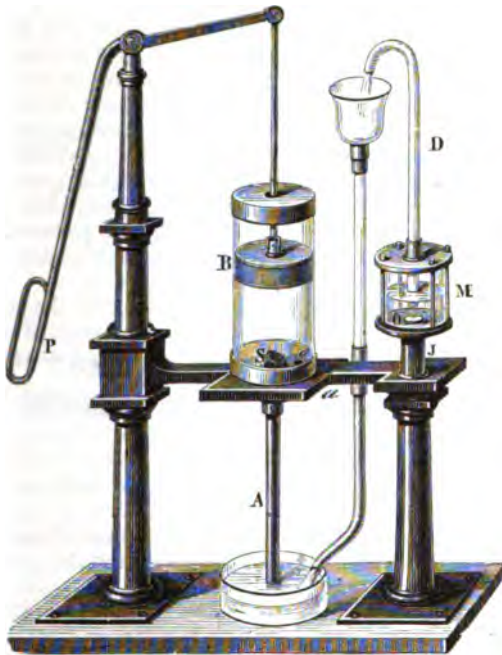

Fig. 172.

At the base of the barrel, where it is connected with the tube A, there is a valve, S, which opens upwards. Another valve, O, opening in the same direction, closes the aperture of a conduit, which passes from a hole, *o*, near the valve S into a vessel, M, which is called the *air chamber*. From this chamber there is another tube, D, up which the water is forced.

At each ascent of the piston B, which is solid, the water rises through the tube A into the barrel. When the piston sinks, the valve S closes, and the water is forced through the valve O into the reservoir M, and from thence into the tube D. The height to which it can be raised in this tube depends solely on the motive force which works the pump.

If the tube D were a prolongation of the tube *Ja*, the flow would be intermittent; it would take place when the piston descended, and would cease

as soon as it ascended. But between these tubes there is an interval, which, by means of the air in the reservoir M, ensures a continuous flow. The water forced into the reservoir M divides into two parts, one of which, rising in D, presses on the water in the reservoir by its weight; while the other, in virtue of this pressure, rises in the reservoir above the lower orifice of the tube D, compressing the air above. Consequently, when the piston ascends, and no longer forces the water into M, the air of the reservoir, by the pressure it has received, reacts on the liquid, and raises it in the tube D, until the piston again descends, so that the jet is continuous.

**205. Load which the piston supports.**—In the suction pump, when once the water fills the pipe and the barrel as far as the spout, *the effort necessary to raise the piston is equal to the weight of a column of water, the base of which is this piston, and the height the vertical distance of the spout from the level of the water in the reservoir, that is, the height to which the water is raised.* For if  $H$  is the atmospheric pressure,  $h$  the height of the water above the piston, and  $h'$  the height of the column which fills the suction tube A (fig. 172), and the lower part of the barrel, the pressure above the piston is obviously  $H + h$ , and that below is  $H - h'$ , since the weight of the column  $h'$  tends to counterbalance the atmospheric pressure. But as the pressure  $H - h'$  tends to raise the piston, the effective resistance is equal to the excess of  $H + h$  over  $H - h'$ , that is to say, to  $h + h'$ .

In the suction and force pump it is readily seen that the pressure which the piston supports is also equal to the weight of a column of water, the base of which is the section of the piston, and the height that to which the water is raised.

**206. Fire engine.**—The fire engine is a force pump in which a steady jet is obtained by the aid of an air chamber, and also by two pumps working alternately (fig. 173). The two pumps  $m$  and  $n$ , worked by the same lever PQ, are immersed in a tank, which is kept filled with water as long as the pump works. From the arrangement of the valves it will be seen, that when one pump  $n$  draws water from the tank, the other  $m$  forces it into the air chamber R; whence, by an orifice Z, it passes into the delivery tube, by which it can be sent in any direction.

Without the air chamber the jet would be intermittent. But as the velocity of the water on entering the reservoir is less than on emerging, the level of the water rises above the orifice Z, compressing the air which fills the reservoir. Hence, whenever the pistons stop, the air thus compressed, reacting on the liquid, forces it out during its momentary stoppage, and thus keeps up a constant flow.

**207. Velocity of efflux. Torricelli's theorem.**—Let us imagine an aperture made in the bottom of any vessel, and consider the case of a particle of liquid on the surface, without reference to those which are beneath. If this particle fell freely, it would have a velocity on reaching the orifice equal to that of any other body falling through the distance between the level of the liquid and the orifice. This, from the laws of falling bodies, is  $\sqrt{2gh}$ , in which  $g$  is the accelerating force of gravity, and  $h$  the height. If the liquid be maintained at the same level, for instance, by a stream of water running into the vessel sufficient to replace what has escaped, the particles will follow one another with the same velocity, and will issue in the form of a stream. Since

pressure is transmitted equally in all directions, a liquid would issue from an orifice in the side with the same velocity provided the depth were the same.

The law of the velocity of efflux was discovered by Torricelli. It may be enunciated as follows : *The velocity of efflux is the velocity which a freely falling body would have on reaching the orifice after having started from a*

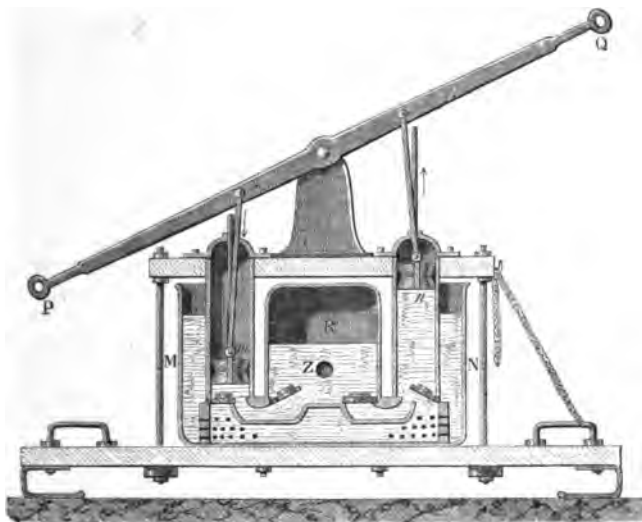

Fig. 173.

*state of rest at the surface.* It is algebraically expressed by the formula  $v = \sqrt{2gh}$ .

It follows directly from this law that the velocity of efflux depends on the depth of the orifice below the surface, and not on the nature of the liquid. Through orifices of equal size and of the same depth, water and mercury would issue with the same velocity, for although the density of the latter liquid is greater, the weight of the column, and consequently the pressure is greater too. It follows further that the velocities of efflux are directly proportional to the square roots of the depth of the orifices. Water would issue from an orifice 100 inches below the surface with ten times the velocity with which it would issue from one an inch below the surface.

The quantities of water which issue from orifices of different areas are very nearly proportional to the size of the orifice, provided the level remains constant.

**208. Direction of the jet from lateral orifices.**—From the principle of the equal transmission of pressure, water issues from an orifice in the side of a vessel with the same velocity as from an aperture in the bottom of a vessel at the same depth. Each particle of a jet issuing from the side of a vessel begins to move horizontally with the velocity above mentioned, but it is at once drawn downward by the force of gravity, in the same manner as a bullet, fired from a gun, with its axis horizontal. It is well known that the bullet



describes a parabola (51) with a vertical axis, the vertex being the muzzle of the gun. Now since each particle of the jet moves in the same curve, the jet itself takes the parabolic form, as shown in fig. 174.

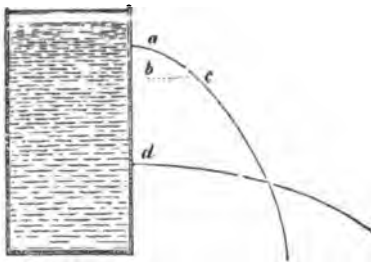

Fig. 174.

It may be remarked, that in every parabola there is a certain point called the *focus*, and that the distance from the vertex to the focus fixes the magnitude of a parabola in much the same manner as the distance from the centre to the circumference fixes the magnitude of a circle. Now it is easily capable of proof that the focus is as much below, as the surface of the water is above, the orifice. Accordingly, the jets formed by water coming from orifices at different depths below the surface take different forms, as shown in fig. 174.

209. **Height of the jet.**—If a jet issuing from an orifice in a vertical direction has the same velocity as a body would have which fell from the surface of the liquid to that orifice, the jet ought to rise to the level of the liquid. It does not, however, reach this; for the particles which fall hinder it. But by inclining the jet at a small angle with the vertical, it reaches about  $\frac{9}{10}$ ths of the theoretical height, the difference being due to friction and to the resistance of the air. By experiments of this nature the truth of Torricelli's law has been demonstrated.

210. **Quantity of efflux. Vena contracta.**—If we suppose the sides of a vessel containing water to be thin, and the orifice to be a small circle whose area is  $A$ , we might think that the quantity of water  $E$  discharged in a second would be given by the expression  $A\sqrt{2gh}$ , since each particle has, on the average, a velocity equal to  $\sqrt{2gh}$ , and particles issue from each point of the orifice. But this is by no means the case. This may be explained by refer-

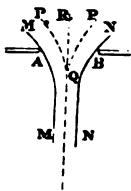

Fig. 175.

ence to fig. 175, in which  $AB$  represents an orifice in the bottom of a vessel—what is true in this case being equally true of an orifice in the side of the vessel. Every particle above  $AB$  endeavours to pass out of the vessel, and in so doing exerts a pressure on those near it. Those that issue near  $A$  and  $B$  exert pressures in the directions  $MM$  and  $NN$ ; those near the centre of the orifice in the direction  $RQ$ , those in the intermediate parts in the directions  $PQ$ ,  $PQ$ . In consequence, the water within the space  $PQP$  is unable to escape, and that which does escape, instead of assuming a cylindrical form, at first contracts, and takes the form of a truncated cone. It is found that the escaping jet continues to contract, until at a distance from the orifice about equal to the diameter of the orifice. This part of the jet is called the *vena contracta*. It is found that the area of its smallest section is about  $\frac{5}{8}$  or  $0.62$  of that of the orifice. Accordingly, the true value of the efflux per second is given approximately by the formula

$$E = 0.62A\sqrt{2gh}$$

or the actual value of  $E$  is about  $0.62$  of its *theoretical amount*.

211. **Influence of tubes on the quantity of efflux.**—The result given in the last article has reference to an aperture in a thin wall. If a cylindrical or conical efflux tube or *ajutage* is fitted to the aperture, the amount of the efflux is considerably increased, and in some cases falls but a little short of its theoretical amount.

A short cylindrical *ajutage*, whose length is from two to three times its diameter, has been found to increase the efflux per second to about  $0.82A\sqrt{2gh}$ . In this case, the water on entering the *ajutage* forms a contracted vein (fig. 177), just as it would do on issuing freely into the air; but afterwards it expands, and, in consequence of the adhesion of the water to the interior surface of the tube, has, on leaving the *ajutage*, a section greater than that of the contracted vein. The contraction of the jet within the *ajutage* causes a partial vacuum. If an aperture is made in the *ajutage*, near the point of greatest contraction, and fitted with a vertical tube, the other end of which dips into water (fig. 176), it is found that water rises in the vertical tube, thereby proving the formation of a partial vacuum.

If the *ajutage* has the form of a conic frustum whose larger end is at the aperture, provided the dimensions are properly chosen, the efflux in a second may be raised to  $0.92A\sqrt{2gh}$ . If the smaller end of a frustum of a cone of suitable dimensions be fitted to the orifice, the efflux may be still further increased, and fall very little short of the theoretical amount.

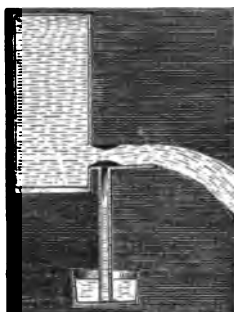

Fig. 176.

When the *ajutage* has more than a certain length, a considerable diminution takes place in the amount of the efflux: for example, if its length is 48 times its diameter, the efflux is reduced to  $0.63A\sqrt{2gh}$ . This arises from the fact, that, when water passes along cylindrical tubes, the resistance increases with the length. The resistance which gives rise to this result is called *hydraulic friction*: it is independent of the material tube, provided it be not roughened; but depends in a considerable degree on the viscosity of the liquid; for instance, ice-cold water experiences a greater resistance than lukewarm water.

According to Prony the mean velocity  $v$  of water in a cast-iron pipe, of the length  $l$ , and the diameter  $d$ , under the pressure  $p$ , is in metres

$$v = 26.8 \sqrt{\frac{dp}{l}}$$

The velocity of efflux through capillary *ajutages* has been found by Poiseuille to be proportionate to the height and not to the square root, a striking exception from Torricelli's theorem.

By means of hydraulic pressure Tresca has submitted solids such as silver, lead, iron and steel, powders like sand, soft plastic substances such as clay, and brittle bodies like ice to such enormous pressures as 100,000 kilogrammes, and has found that they then behave like fluid bodies. His experiments show also that these bodies transmit pressure in all directions when this pressure is considerable enough.

212. **Form of the jet.**—After the contracted vein, the jet has the form of a solid rod for a short distance, but then begins to separate into drops which present a peculiar appearance. They seem to form a series of ventral and nodal segments (fig. 177). The ventral segments consist of drops extended in a horizontal direction, and the nodal segments in a longitudinal direction.

And as the ventral and nodal segments have respectively a fixed position, each drop must alternately become elongated and flattened while it is falling (fig. 178). Between any two drops there are smaller ones, so that the whole jet has a tube-like appearance.

If the jet is momentarily illuminated by the electric spark its structure is well seen; the drops appear then to be stationary, and separate from each other.

If the aperture is not circular the form of the jet undergoes curious changes.

213. **Hydraulic tourniquet.**—If water be contained in a vessel, and an aperture made in one of the sides, the pressure at this point is removed, for



Fig. 177.



Fig. 178.



Fig. 179.

it is expended in sending out the water: but it remains on the other side; and if the vessel were moveable in a horizontal direction, it would move in a direction opposite that of the issuing jet. This is illustrated by the apparatus known as the *hydraulic tourniquet*, or *Barker's mill* (fig. 179). It consists of a glass vessel, M, containing water, and capable of moving about its vertical axis. At the lower part there is a tube, C, bent horizontally in opposite directions at the two ends. If the vessel were full of water and the tubes closed, the pressures on the sides of C would balance each other, being equal and acting in contrary directions; but, being open, the water runs out, the pressure is not exerted on the open part, but only on the opposite side, as

shown in the figure A. And this pressure, not being neutralised by an opposite pressure, imparts a rotatory motion in the direction of the arrow, the velocity of which increases with the height of the liquid and the size of the aperture.

The same principle may be illustrated by the following experiment. A tall cylinder containing water and provided with a lateral stopcock near the bottom is placed on a light shallow dish on water, so that it easily floats. On opening the stopcock so as to allow water to flow out, the vessel is observed to move in a direction diametrically opposite to that in which the water is issuing.

Segner's water-wheel and the reaction machine depend on this principle. So also do rotating fireworks; that is, an unbalanced reaction from the heated gases which issue from openings in them, gives them motion in the opposite direction.

**214. Water-wheels. Turbines.**—When water is continuously flowing from a higher to a lower level, it may be used as a motive power. The water power of the Niagara Falls is equal to a quarter of a million of horse power. The motive power of water is utilised by means of *water-wheels*; that is, by wheels provided with buckets or float-boards at the circumference, and on which the water acts either by pressure or by impact.

Water-wheels turn in a vertical plane round a horizontal axis, and are of two principal kinds, *undershot* and *overshot*.

In *undershot* wheels the float-boards are at right angles to the circumference of the wheel. The lowest float-boards are immersed in the water, which flows with a velocity depending on the height of the fall. Such wheels are applicable where the quantity of water is great, but the fall inconsiderable. *Overshot* wheels are used with a small quantity of water which has a high fall, as with small mountain streams. On the circumference of the wheel there are buckets of a peculiar shape. The water falls into the buckets on the upper part of the wheel, which is thus moved by the weight of the water, and as each bucket arrives at the lowest point of revolution it discharges all the water, and ascends empty.

The *turbine* is a horizontal water-wheel, and is similar in principle to the hydraulic tourniquet (213). But instead of the horizontal tubes there is a horizontal drum, containing curved vertical walls; the water, in issuing from the turbine, pressing against these walls, exerts a reaction, and turns the whole wheel about a vertical axis. Turbines have the advantage of being of small bulk for their power, and equally efficient for the highest and the lowest falls.

Water power is usually represented by the weight of the water multiplied into the height of the fall; or it may also be represented by half the product of the mass into the square of the velocity. Both measurements give the same result (61).

The total theoretical effect of a water power is never realised; for the water, after acting on the wheel, still retains some velocity, and therefore does not impart the whole of its velocity to the wheel; in many cases water flows past without acting at all; if the water acts by impact, vibrations are produced which are transmitted to the earth and lost; the same effect is produced by the friction of water over an edge of the sluice, in the channel

which conveys it, or against the wheel itself, as well as by the friction of this latter against the axle. A wheel working freely in a stream, as with the corn mills on the Rhine near Mainz, does not utilise more than 20 per cent. of the theoretical effect, while one of the more perfect forms of turbines will work up to over 80 per cent. Water engines in this respect exceed steam engines, which on the average do not use more than 10 per cent. of the power represented by the coal they burn.

215. **Mariotte's bottle, its use.**—Mariotte's bottle presents many curious effects of the pressure of the atmosphere, and furnishes a means of obtaining a constant flow of water. It consists of a large narrow-mouthed bottle in the neck of which there is a tightly-fitting cork (fig. 180). Through this a tube passes open at both ends. In the sides of the bottle there are three tubulures, each with a narrow orifice, and which can be closed at will.



Fig. 180.

The bottle and the tube being quite filled with water, let us consider what will be the effect of opening successively one of the tubulures, *a*, *b*, and *c*, supposing, as represented in the figure, that the lower extremity of *g* is between the tubulures *b* and *c*.

i. If the tubulure *b* is open the water flows out, and the surface sinks in the tube *g* until it is on the same level as *b*, when the flow stops. This flow arises from the excess of pressure at the point *e* over that at *b*. The pressure at *e* is the same as the pressure of the atmosphere. But when once the level is the same at *b* and at *e*, the efflux ceases, for the

atmospheric pressure on all points of the same horizontal layer, *be*, is the same (100).

ii. If now the tubulure *b* is closed, and *a* opened, no efflux takes place; on the contrary, air enters by the orifice *a*, and water ascends in the tube *g*, as high as the layer *ad*, and then equilibrium is established.

iii. If the orifices *a* and *b* are closed, and *c* opened, an efflux having constant velocity takes place, as long as the level of the water is not below the open end, *l*, of the tube. Air enters bubble by bubble at *l*, and takes the place of the water which has flowed out.

In order to show that the efflux at the orifice *c* is constant, it is necessary to demonstrate that the pressure on the horizontal layer *ch* is always equal to that of the atmosphere in addition to the pressure of the column *hl*. Now suppose that the level of the water has sunk to the layer *ad*. The air which has penetrated into the flask supports a pressure equal to that of the atmosphere diminished by that of the column of liquid *pn*, or  $H - pn$ . In virtue of its elasticity this pressure is transmitted to the layer *ch*. But this layer further supports the weight of a column of water, *pm*, so that the pressure at *m* is really  $pm + H - pn$ , or  $H + mn$ , that is to say,  $H + hl$ .

In the same manner it may be shown that this pressure is the same when the level sinks to *b*, and so on as long as the level is higher than the aperture

*l*. The pressure on the layer *ch* is therefore constant, and consequently the velocity of the efflux. But when once the level is below the point *l*, the pressure decreases, and with it the velocity.

To obtain a constant flow by means of Mariotte's bottle, it is filled with water, and the orifice which is below the tube *l* is opened. The rapidity of the flow is proportional to the square root of the height *hl*.

BOOK V.  
ACOUSTICS.

---

CHAPTER I.

PRODUCTION, PROPAGATION, AND REFLECTION OF SOUND.

216. **Object of acoustics.**—The study of sounds, and that of the vibrations of elastic bodies, form the object of *acoustics*.

Music considers sounds with reference to the pleasurable feelings they are calculated to excite. Acoustics is concerned with the questions of the production, transmission, and comparison of sounds ; to which may be added, the physiological question of the perception of sounds.

217. **Sound and noise.**—*Sound* is a peculiar sensation excited in the organ of hearing by the vibratory motion of bodies, when this motion is transmitted to the ear through an elastic medium.

All sounds are not identical ; they present differences by which they may be distinguished, compared, and their relations determined.

Sounds are distinguished from *noises*. Sound properly so called, or *musical sound*, is that which produces a continuous sensation, and the musical value of which can be determined, while noise is either a sound of too short a duration to be determined, like the report of a cannon ; or else it is a confused mixture of many discordant sounds, like the rolling of thunder or the noise of the waves. Nevertheless the difference between sound and noise is by no means precise ; Savart has shown that there are relations of height in the case of noise, as well as in that of sound : and there are said to be certain ears sufficiently well organised to determine the musical value of the sound produced by a carriage rolling on the pavement.

218. **Cause of sound.**—Sound is always the result of rapid oscillations imparted to the molecules of elastic bodies, when the state of equilibrium of these bodies has been disturbed either by a shock or by friction. Such bodies tend to regain their first position of equilibrium, but only reach it after performing, on each side of that position, very rapid vibratory movements, the amplitude of which quickly decreases. A body which produces a sound is called a *sonorous* body.

As understood in England and Germany, a vibration comprises a motion to *and fro* ; in France, on the contrary, a vibration means a movement to *or fro*. The French vibrations are with us semi-vibrations, an *oscillation* or *vibration* is the movement of the vibrating molecule in only one direction ; a *double* or *complete vibration* comprises the oscillation both backwards and forwards.

Vibrations are very readily observed. If a light powder is sprinkled on a body which is in the act of yielding a musical sound, a rapid motion is imparted to the powder which renders visible the vibrations of the body ; and in the same manner, if a stretched cord be smartly pulled and let go its vibrations are apparent to the eye.

A bell jar is held horizontally in one hand (fig. 181), and made to vibrate by being struck with the other ; if then a piece of metal is placed in it, it is rapidly raised by the vibrations of the side ; touching the bell-jar with the hand, the sound ceases, and with it the motion of the metal.

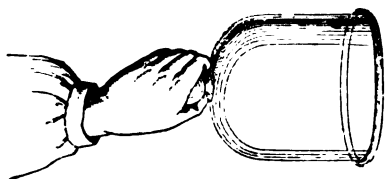

Fig. 181.

**219. Sounds not propagated**

**in vacuo.**—The vibrations of elastic bodies can only produce the sensation of sound in us by the intervention of a medium interposed between the ear and the sonorous body and vibrating with it. This medium is usually the air, but all gases, vapours, liquids, and solids also transmit sounds.

The following experiment shows that the presence of a ponderable medium is necessary for the propagation of sound. A small metal bell, which is continually struck by a small hammer by means of clockwork, or else an ordinary musical box, is placed under the receiver of an air-pump (fig. 182). As long as the receiver is full of air at the ordinary pressure, the sound is transmitted, but in proportion as the air is exhausted the sound becomes feebler, and is imperceptible in a vacuum.

To ensure the success of the experiment, the bellwork or musical box must be placed on wadding ; for otherwise the vibrations would be transmitted to the air through the plate of the machine.

**220. Sound is propagated in all elastic bodies.**—If, in the above experiment, after the vacuum has been made, any vapour or gas be admitted, the sound of the bell will be heard, showing that sound is propagated in this medium as in air.

Sound is also propagated in liquids. When two bodies strike against each other under water the shock is distinctly heard.

And a diver at the bottom of the water can hear the sound of voices on the bank.

The conductivity of solids is such, that the faint scratching of a pen at the end of a long piece of wood is heard at the other end. The earth conducts sound so well, that at night, when the ear is applied to the ground, the steps of horses or any other noise at a great distance is heard.



Fig. 182.



221. **Propagation of sound in the air.**—In order to simplify the theory of the propagation of sound in the air, we shall first consider the case in which it is propagated in a cylindrical tube of indefinite length. Let  $MN$ , fig. 183, be a tube filled with air at a constant pressure and temperature, and

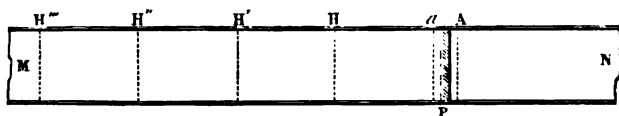

Fig. 183.

let  $P$  be a piston oscillating rapidly from  $A$  to  $a$ . When the piston passes from  $A$  to  $a$  it compresses the air in the tube. But in consequence of the great compressibility, the condensation of the air does not take place at once throughout the whole length of the tube, but solely within a certain length,  $aH$ , which is called the *condensed wave*.

If the tube  $MN$  be supposed to be divided into lengths equal to  $aH$ , and each of these lengths divided into layers parallel to the piston, it may be shown by calculation, that when the first layer of the wave  $aH$  comes to rest, the motion is communicated to the first layer of the second wave  $H'H'$ , and so on from layer to layer in all parts of  $H'H''$ ,  $H''H'''$ . The condensed wave advances in the tube, each of its parts having successively the same degree of velocity and condensation.

When the piston returns in the direction  $aA$ , a vacuum is produced behind it, which causes an expansion of the air in contact with its posterior face. The next layer expanding in turn brings the first to its original state of condensation, and so on from layer to layer. Thus when the piston has returned to  $A$ , an *expanded wave* is produced of the same length as the condensed wave, and directly following it in the tube where they are propagated together, the corresponding layers of the two waves possessing equal and contrary velocities.

The whole of a condensed and expanded wave forms an *undulation*; that is, an undulation comprehends that part of the column of air affected during the backward and forward motion of the piston. The *length of an undulation* is the space which sound traverses during a complete vibration of the body which produces it. This length is less in proportion as the vibrations are more rapid.

It is important to remark that if we consider a single row of particles, which when at rest occupy a line parallel to the axis of the cylinder, for instance, these along  $AH''$  (fig. 183), we shall find they will have respectively at the same instant all the various velocities which the piston has had successively while oscillating from  $A$  to  $a$  and back to  $A$ . So that if in fig. 35  $AH'$  represents the length of one undulation, the curved line  $H'PQA$  will represent the various velocities which all the points in the line  $AH'$  have *simultaneously*: for instance, at the instant the piston has returned to  $A$ , the particle at  $M$  will be moving to the right with a velocity represented by  $QM$ , the particle at  $N$  will be moving to the left with a velocity represented by  $PN$ , and so on of the other particles.

When an undulatory motion is transmitted through a medium, the

motions of any two particles are said to be in the same *phase* when those particles move with equal velocities in the same direction; the motions are said to be in opposite phases when the particles move with the same velocities in opposite directions. It is plain, from an inspection of fig. 35, that when any two particles are separated by a distance equal to half an undulation, their motions are always in opposite phases, but if their distance equals the length of a complete undulation their motions are in the same phase.

A little consideration will show that in the *condensed wave* the condensation will be greatest at the middle of the wave, and likewise that the *expanded wave* will be most rarefied at its middle.

It is an easy transition from the theory of the motion of sonorous waves in a cylinder to that of their motion in an unenclosed medium. It is simply necessary to apply, in all directions, to each molecule of the vibrating body what has been said about a piston movable in a tube. A series of spherical waves alternately condensed and rarefied is produced around each centre of disturbance. As these waves are contained within two concentric spherical surfaces, whose radii gradually increase, while the length of the undulation remains the same, their mass increases with the distance from the centre of disturbance, so that the amplitude of the vibration of the molecules gradually lessens, and the intensity of the sound diminishes.

It is these spherical waves, alternately condensed and expanded, which in being propagated transmit sound. If many points are disturbed at the same time, a system of waves is produced around each point. But all these waves are transmitted one through the other without modifying either their lengths or their velocities. Sometimes condensed or expanded waves coincide with others of the same nature to produce an effect equal to their sum; sometimes they meet and produce an effect equal to their difference. If the surface of still water be disturbed at two or more points, the co-existence of waves becomes sensible to the eye.

**222. Causes which influence the intensity of sound.**—Many causes modify the force or the *intensity* of sound. These are, the distance of the sonorous body, the amplitude of the vibrations, the density of the air at the place where the sound is produced, the direction of the currents of air, and, lastly, the neighbourhood of other sonorous bodies.

i. *The intensity of sound is inversely as the square of the distance of the sonorous body from the ear.* This law has been deduced by calculation, but it may be also demonstrated experimentally. Let us suppose several sounds of equal intensity—for instance, bells of the same kind, struck by hammers of the same weight, falling from equal heights. If four of these bells are placed at a distance of 20 yards from the ear, and one at a distance of 10 yards, it is found that the single bell produces a sound of the same intensity as the four bells struck simultaneously. Consequently, for double the distance the intensity of the sound is only one-fourth. A method of comparing the intensities of different sounds will be described afterwards (282).

The distance at which sounds can be heard depends on their intensity. The report of a volcano at St. Vincent was heard at Demerara, 300 miles off, and the firing at Waterloo was heard at Dover.

ii. *The intensity of the sound increases with the amplitude of the vibrations*

*of the sonorous body.* The connection between the intensity of the sound and the amplitude of the vibrations is readily observed by means of vibrating cords. For if the cords are somewhat long, the oscillations are perceptible to the eye, and it is seen that the sound is feebler in proportion as the amplitude of the oscillations decreases.

iii. *The intensity of sound depends on the density of the air in the place in which it is produced.* As we have already seen (219), when an alarum moved by clockwork is placed under the bell-jar of an air-pump, the sound becomes weaker in proportion as the air is rarefied.

In hydrogen, which is about  $\frac{1}{14}$ th the density of air, sounds are much feebler, although the pressure is the same. In carbonic acid, on the contrary, whose density is 1.529, sounds are more intense. On high mountains, where the air is much rarefied, it is necessary to speak with some effort in order to be heard, and the discharge of a gun produces only a feeble sound.

The ticking of a watch is heard in water at a distance of 73 feet, in oil of 16½, in alcohol of 13, and in air of only 10 feet.

iv. *The intensity of sound is modified by the motion of the atmosphere, and the direction of the wind.* In calm weather sound is always better propagated than when there is wind; in the latter case, for an equal distance, sound is more intense in the direction of the wind than in the contrary direction.

v. Lastly, *sound is strengthened by the proximity of a sonorous body.* A string made to vibrate in free air and not near a sounding body has but a very feeble sound; but when it vibrates above a sounding-box, as in the case of the violin, guitar, or violoncello, its sound is much more intense.



Fig. 184.

This arises from the fact that the box and the air which it contains vibrate in unison with the string. Hence the use of sounding-boxes in stringed instruments.

223. **Apparatus to strengthen sound.**—The apparatus represented in fig. 184 was used by Savart to show the influence of boxes in strengthening sound. It consists of a hemispherical brass vessel, A, which is set in vibration by means of a violin bow. Near it there is a hollow cardboard cylinder, B, closed at the further end. By means of a handle this cylinder can be turned on its support, so as to be inclined at any given degree towards the vessel. The cylinder is fixed on a slide, C, by which means it can be placed at any distance from A. When the vessel is made to vibrate, the strengthening of the sound is very remarkable. But the sound loses almost all its intensity if the cylinder is turned away, and it becomes gradually weaker when the cylinder is removed to a greater distance, showing that the strengthening is due to the vibration of the air in the cylinder.

The cylinder B is made to vibrate in unison with the brass vessel by adjusting it to a certain depth, which is effected by making one part slide into the other.

Vitruvius states that, in the theatres of the ancients, resonant brass vessels were placed to strengthen the voices of the actors.

224. **Influence of tubes on the transmission of sound.**—The law that the intensity of sound increases in inverse proportion to the square of the distance does not apply to the case of tubes, especially if they are straight and cylindrical. The sonorous waves in that case are not propagated in the form of increasing concentric spheres, and sound can be transmitted to a great distance without any perceptible alteration. M. Biot found that in one of the Paris water pipes, 1040 yards long, the voice lost so little of its intensity, that a conversation could be kept up at the ends of a tube in a very low tone. The weakening of sound becomes, however, perceptible in tubes of large diameter, or where the sides are rough. This property of transmitting sounds was first used in England for *speaking tubes*. They consist of caoutchouc tubes of small diameter passing from one room to another. If a person speaks at one end of the tube, he is distinctly heard by a person with his ear at the other end.

From M. Biot's experiments it is evident that a communication might be made between two towns by means of speaking tubes. The velocity of sound is 1125 feet in a second at 16.6 C., so that a distance of 50 miles would be traversed in four minutes.

225. **Regnault's experiments.**—Theoretically a sound wave should be propagated in a straight cylindrical tube with a constant intensity. Regnault has found that under these circumstances the intensity of sound gradually diminishes with the distance, and that the distance at which it ceases to be audible is nearly proportional to the diameter of the tube.

He produced sound waves of equal strength by means of a small pistol charged with a gramme of powder and fired at the open end of tubes of various diameters, and he then ascertained the distance at which the sound could no longer be heard, or at which it ceased to act on what he calls a *sensitive membrane*. This was a very flexible membrane which could be fixed at various distances across the tube, and provided with a small metal disc in its centre. When the membrane began to vibrate this disc struck against a metallic contact and thereby closed a voltaic circuit, which

traced on a chronograph the exact moment at which the membrane received the sound wave.

Experimenting in this manner, M. Regnault found that the report of a pistol charged as stated is no longer audible at a distance of

1159 metres in a tube of	.	.	.	.	.	0 <sup>m</sup> 108 diameter
3810	"	"	.	.	.	0 <sup>m</sup> 300 "
9540	"	"	.	.	.	1 <sup>m</sup> 100 "

The sound wave of which these numbers represent the limit of distance at which it is no longer heard, still acts on the membrane at the distances of 4156, 11430 and 19851 metres respectively.

According to Regnault the principal cause of this diminution of intensity is the loss of vis viva against the sides of the tube; he found also that sounds of high pitch are propagated in tubes less easily than those of low ones; a bass would be heard at a greater distance than a treble voice.

226. **Velocity of sound in gases.**—Since the propagation of sonorous waves is gradual, sound requires a certain time for its transmission from one place to another, as is seen in numerous phenomena. For example, the sound of thunder is only heard some time after the flash of lightning has been seen, although both the sound and the light are produced simultaneously; and in like manner we see a mason in the act of striking a stone before hearing the sound.

The velocity of sound in air has often been the subject of experimental determination.

The most accurate of the direct measurements was made by Moll and Van Beck in 1823. Two hills, near Amsterdam, Kooltjesberg and Zeven-boomen, were chosen as stations; their distance from each other as determined trigonometrically was 57,971 feet, or nearly eleven miles. Cannon were fired at stated intervals simultaneously at each station, and the time which elapsed between seeing the flash and hearing the sound was noted by chronometers. This time could be taken as that which the sound required to travel between the two stations; for it will be subsequently seen that light takes an inappreciable time to traverse the above distance. Introducing corrections for the barometric pressure, temperature and hygrometric state, and eliminating the influence of the wind, Moll and Van Beck's results as recalculated by Schröder van der Kolk give 1092·78 feet as the velocity of sound in one second in dry air at 0° C. and under a pressure of 760 mm.

The velocity of sound at zero may be taken at 1093 feet or 333 metres. This velocity increases with the increase of temperature; it may be calculated for any temperature  $t^{\circ}$  from the formula,

$$v = 1093\sqrt{(1 + 0\cdot003665t)}$$

where 1093 is the velocity in feet at 0° C., and 0·003665 the coefficient of expansion for 1° C. This amounts to an increase of nearly two feet for every degree centigrade. For the same temperature it is independent of the density of the air, and consequently of the pressure. It is the same for the same temperature with all sounds, whether they be strong or weak, deep or acute. M. Biot found, in his experiments on the conductivity of sound in tubes,

that when a well-known air was played on a flute at one end of a tube 1040 yards long, it was heard without alteration at the other end, from which he concluded that the velocity of different sounds is the same. For the same reason the tune played by a band is heard at a great distance without alteration, except in intensity, which could not be the case if some sounds travelled more rapidly than others.

This cannot, however, be admitted as universally true. Earnshaw, by a profound mathematical investigation of the laws of the propagation of sound, has found that the velocity of a sound depends on its strength; and, accordingly, that a violent sound ought to be propagated with greater velocity than a gentler one. This conclusion is confirmed by an observation made by Captain Parry on his Arctic expedition. During artillery practice it was found, by persons stationed at a considerable distance from the guns, that the report of the cannon was heard before the command of fire given by the officer. And more recently, Mallet made a series of experiments on the velocity with which sound is propagated in rocks, by observing the times which elapsed before blastings, made at Holyhead, were heard at a distance. He found that the larger the charge of gunpowder, and therefore the louder the report, the more rapid was the transmission. With a charge of 2000 pounds of gunpowder, the velocity was 967 feet in a second, while with a charge of 12,000 it was 1210 feet in the same time.

M. Bravais and Martins found, in 1844, that sound travelled with the same velocity from the base to the summit of the Faulhorn, as from the summit to the base.

Mallet has investigated the velocity of the transmission of sound in various rocks, and finds that it is as follows :

Wet sand . . . . .	825 ft. in a second.
Contorted, stratified quartz and slate rock . . . . .	1088 "
Discontinuous granite . . . . .	1306 "
Solid granite . . . . .	1664 "

227. **Formulæ for calculating the velocity of sound in gases.**—From theoretical considerations Newton gave a rule for calculating the velocity of sound in gases, which may be represented by the formula

$$v = \sqrt{\frac{e}{d}}$$

in which  $v$  represents the velocity of the sound or the distance it travels in a second,  $e$  the elasticity of the gas, and  $d$  its density.

This formula expresses that the velocity of the propagation of sound in gases is directly as the square root of the elasticity of the gas, and inversely as the square root of its density. It follows that the velocity of sound is the same under any pressure; for although the elasticity increases with increased pressure, according to Boyle's law, the density increases in the same ratio. At Quito, where the mean pressure is only 21.8 inches, the velocity is the same as at the sea level, provided the temperature is the same.

If  $g$  be the force of gravity,  $h$  the barometric height reduced to the temperature zero, and  $\delta$  the density of mercury, also at zero, then for a gas under

the atmospheric pressure, and for zero,  $c = gh\delta$ ; Newton's formula accordingly becomes

$$v = \sqrt{\frac{gh\delta}{d}}$$

Now if we suppose the temperature of a gas to increase from  $0^\circ$  to  $t^\circ$ , its volume will increase from unity at zero to  $1 + at$  at  $t$ ,  $a$  being the coefficient of expansion of the gas. But the density varies inversely as the volume, therefore  $d$  becomes  $d + (1 + at)$ . Hence

$$v = \sqrt{\frac{gh}{d} (1 + at)}$$

The values of  $v$ , obtained by this formula, are less than the experimental results. Laplace assigned as a reason for this discrepancy the heat produced by pressure in the condensed waves; and, by considerations based on this idea, Poisson and Biot have found that Newton's formula ought to be written

$v = \sqrt{\frac{gh}{d} (1 + at) \frac{c}{c'}}$ ;  $c$  being the specific heat of the gas for a constant pressure, and  $c'$  its specific heat for a constant volume (see Book VI.). When thus modified the results calculated by the formula agree with the experimental results.

The physical reason for introducing the constant  $\frac{c}{c'}$  into the equation for the velocity of sound may be understood from the following considerations. We have already seen that sound is propagated in air by a series of alternate condensations and rarefactions of the layers. At each condensation heat is evolved, and this heat increases the elasticity, and thus the rapidity, with which each condensed layer acts on the next; but in the rarefaction of each layer, the same amount of heat disappears as was developed by the condensation, and its elasticity is diminished by the cooling. The effect of this diminished elasticity of the cooled layer is the same as if the elasticity of an adjacent wave had been increased, and the rapidity with which this latter would expand upon the dilated wave would be greater. Thus, while the average temperature of the air is unaltered, both the heating which increases the elasticity, and the chilling which diminishes it, concur in increasing velocity.

Knowing the velocity of sound, we can calculate approximately the distance at which it is produced. Light travels with such velocity that the flash or the smoke accompanying the report of a gun may be considered to be seen simultaneously with the explosion. Counting then the number of seconds which elapse between seeing the flash and hearing the sound, and multiplying this number by 1125, we get the distance in feet at which the gun is discharged. In the same way the distance of thunder may be estimated.

**228. Velocity of sound in various gases.**—Approximately the same results have been obtained for the velocity of sound in air by another method, by which the velocity in other gases could be determined. As the wave length  $\lambda$  is the distance which sound travels during the time of one oscillation,

that is  $\frac{1}{n}$  of a second, the velocity of sound or the distance traversed in a second is  $v = n\lambda$ . Now the length of an open pipe is half the wave length

of the fundamental note of that pipe ; and that of a closed pipe is a quarter of the wave length (268). Hence, if we know the number of vibrations of the note emitted by any particular pipe, which can be easily ascertained by means of a syren, and we know the length of this pipe, we can calculate  $v$ . Taking the temperature into account, Wertheim found 1086 feet for the velocity of sound at zero.

Further, since in different gases which have the same elasticity, but differ in density, the velocity of sound varies inversely as the square root of the density, knowing the velocity of sound in air, we may calculate it for other gases ; thus, in hydrogen it will be

$$\frac{1093}{\sqrt{0.0688}} = 4168 \text{ feet.}$$

This number cannot be quite accurate, for the coefficient  $\frac{c}{c_1}$  differs somewhat in different gases. And when pipes were sounded with different gases, and the number of vibrations of the notes multiplied with twice the length of the pipe, numbers were obtained which differed from those calculated by the above formula. When, however, the calculation was made, introducing for each gas the special value of  $\frac{c}{c_1}$ , the theoretical results agreed very well with the observed ones.

By the above method the following values have been obtained :—

Carbonic acid . . . . .	856 ft. in a second.
Oxygen . . . . .	1040 ”
Air . . . . .	1093 ”
Carbonic oxide . . . . .	1106 ”
Hydrogen . . . . .	4163 ”

229. **Doppler's principle.**—When a sounding body approaches the ear, the tone perceived is somewhat higher than the true one ; but if the source of sound recedes from the ear, the tone perceived is lower. The truth of this, which is known as *Doppler's principle*, will be apparent from the following considerations :—When the source of sound and the ear are at rest, the ear perceives  $n$  waves in a second ; but if the ear approaches the sound, or the sound approaches the ear, it perceives more ; just as a ship meets more waves when it ploughs through them than if it is at rest. Conversely, the ear receives a smaller number when it recedes from the source of sound. The effect in the first case is as if the sounding body emitted more vibrations in a second than it really does, and in the second case fewer. Hence in the first case the note appears higher ; in the second case lower.

If the distance which the ear traverses in a second towards the source of sound (supposed to be stationary) is  $s$  feet, and the wave length of the particular tone is  $\lambda$  feet, then there are  $\frac{s}{\lambda}$  waves in a second ; or also  $\frac{ns}{c}$  for  $\lambda = \frac{c}{n}$ , where  $c$  is the velocity of sound (226). Hence the ear receives not only the  $n$  original waves, but also  $\frac{ns}{c}$  in addition. Therefore the number



of vibrations which the ear actually perceives is

$$n' = n + \frac{ns}{c} = n \left(1 + \frac{s}{c}\right)$$

for an ear which approaches a tone ; and by similar reasoning it is

$$n' = n - \frac{ns}{c} = n \left(1 - \frac{s}{c}\right)$$

for an ear receding from a tone.

To test Doppler's theory Buys Ballot stationed trumpeters on the Utrecht Railway, and also upon locomotives, and had the height of the approaching or receding tones compared with stationary ones by musicians. He thus found both the principle and the formula fully confirmed. The observation may often be made as a fast train passes a station in which an electrical alarm is sounding. Besides the difference in loudness, an attentive ear can detect a difference in pitch on approaching or leaving the station.

230. **Velocity of sound in liquids and in solids.**—The velocity of sound in water was investigated in 1827 by Colladon and Sturm. They moored two boats at a known distance in the lake of Geneva. The first supported a bell immersed in water, and a bent lever provided at one end with a hammer which struck the bell, and at the other with a lighted wick, so arranged that it ignited some powder the moment the hammer struck the bell. To the second boat was affixed an ear-trumpet, the bell of which was in water, while the mouth was applied to the ear of the observer, so that he could measure the time between the flash of light and the arrival of sound by the water. By this method the velocity was found to be 4708 feet in a second at the temperature 8.1°, or four times as great as in air.

The velocity of sound, which is different in different liquids, can be calculated by a formula analogous to that given above (228) as applicable to gases. In this way are obtained the numbers given in the following table. As in the case of gases, the velocity varies with the temperature, which is therefore appended in each case :—

River water (Seine)	. . .	13° C.	= 4714 ft. in a second.
" " "	. . .	30	= 5013 "
Artificial sea-water	. . .	20	= 4761 "
Solution of common salt	. . .	18	= 5132 "
" " chloride of calcium	. . .	23	= 6493 "
Absolute alcohol	. . .	23	= 3804 "
Turpentine	. . .	24	= 3976 "
Ether	. . .		= 3801 "

As a general rule, this elasticity of solids, as compared with the density, is greater than that of liquids, and consequently the propagation of sound is more rapid.

The difference is well seen in an experiment by M. Biot, who found that when a bell was struck by a hammer, at one end of an iron tube 3120 feet long, two sounds were distinctly heard at the other end. The first of these was transmitted by the tube itself with a velocity  $x$ ; and the second by the enclosed air with a known velocity  $a$ . The interval between the sounds was 2.5 seconds. The value of  $x$  obtained from the equation

$$\frac{3120}{a} - \frac{3120}{x} = 2.5$$

shows that the velocity of sound in the tube is about 9 times as great as that in air.

To this class of phenomena belongs the fact that if the ear is held against a rock in which a blasting is being made at a distance, two distinct reports are heard, one transmitted through the rock to the ear, and the other transmitted through the air. The conductivity of sound in solids is also well illustrated by the fact that in manufacturing telegraph wires the filing at any particular part can be heard at distances of miles by placing one end of the wire in the ear.

The velocity of sound in solids has also been determined theoretically by Wertheim, by means of their coefficient of elasticity.

The following table gives the velocity in various bodies, expressed in feet per second :—

Lead . . . . .	4030	Pine . . . . .	10900
Gold . . . . .	5717	Oak . . . . .	12622
Silver . . . . .	8553	Ash . . . . .	13314
Copper . . . . .	11666	Elm . . . . .	13516
Steel wire . . . . .	15470	Fir . . . . .	15218
Iron . . . . .	16822	Aspen . . . . .	16677

The velocity in the direction of the fibres was greater than across them.

A direct method of determining the velocity of sound in solids, gases, and vapours will be described further on (270).

231. **Reflection of sound.**—So long as sound waves are not obstructed in their motion they are propagated in the form of concentric spheres; but when they meet with an obstacle, they follow the general law of elastic bodies; that is, they return upon themselves, forming new concentric waves, which seem to emanate from a second centre on the other side of the obstacle. This phenomenon constitutes the reflection of sound.

Fig. 185 represents a series of incident waves reflected from an obstacle, PQ. Taking, for example, the incident wave MCDN, emitted from the centre A, the corresponding reflected wave is represented by the arc, CKD, of a circle, whose centre *a* is as far beyond the obstacle PQ as A is before it.

If any point, C, of the reflecting surface be joined to the sonorous centre, and if the perpendicular CH be let fall on the surface of this body, the angle ACH is called the *angle of incidence*, and the angle BCH, formed by the prolongation of *aC* is the *angle of reflection*.

The reflection of sound is subject to the two following laws :—

I. *The angle of reflection is equal to the angle of incidence.*

II. *The incident sonorous ray and the reflected ray are in the same plane perpendicular to the reflecting surface.*

From these laws it follows that the wave which in the figure is propagated in the direction AC, takes the direction CB after reflection, so that an observer placed at B hears, besides the sound proceeding from the point A, a second sound, which appears to come from C.

The laws of the reflection of sound are the same as those for light and radiant heat, and may be demonstrated by similar experiments. One of the simplest of these is made with conjugate mirrors (see chapter on Radiant

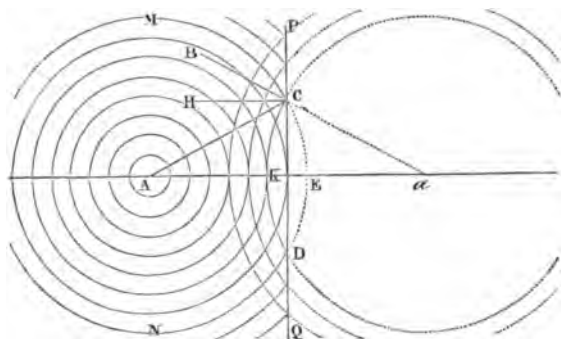

Fig. 185.

Heat); if in the focus of one of these mirrors a watch is placed, the ear placed in the focus of the second mirror hears the ticking very distinctly, even when the mirrors are at a distance of 12 or 13 yards.

232. **Echoes and resonances.**—An *echo* is the repetition of a sound in the air, caused by its reflection from some obstacle.

A very sharp quick sound can produce an echo when the reflecting surface is 55 feet distant, but for articulate sounds at least double that distance is necessary, for it may be easily shown that no one can pronounce or hear distinctly more than five syllables in a second. Now, as the velocity of sound at ordinary temperatures may be taken at 1125 feet in a second, in a fifth of that time sound would travel 225 feet. If the reflecting surface is 112.5 feet distant, in going and returning sound would travel through 225 feet. The time which elapses between the articulated and the reflected sound would, therefore, be a fifth of a second, the two sounds would not interfere, and the reflected sound would be distinctly heard. A person speaking with a loud voice in front of a reflector, at a distance of 112.5 feet, can only distinguish the last reflected syllable: such an echo is said to be *monosyllabic*. If the reflector were at a distance of two or three times 112.5 feet, the echo would be *dissyllabic*, *trisyllabic*, and so on.

When the distance of the reflecting surface is less than 112.5 feet the direct and the reflected sound are confounded. They cannot be heard separately, but the sound is strengthened. This is what is called *resonance*, and is often observed in large rooms. Bare walls are very resonant; but tapestry and hangings, which are bad reflectors, deaden the sound.

*Multiple echoes* are those which repeat the same sound several times: this is the case when two opposite surfaces (for example, two parallel walls) successively reflect sound. There are echoes which repeat the same sound 20 or 30 times. An echo in the château of Simonetta, in Italy, repeats a

sound 30 times. At Woodstock there is one which repeats from 17 to 20 syllables.

As the laws of reflection of sound are the same as those of light and heat, curved surfaces produce *acoustic foci* like the luminous and calorific foci produced by concave reflectors. If a person standing under the arch of a bridge speaks with his face turned towards one of the piers, the sound is reproduced near the other pier with such distinctness that a conversation can be kept up in a low tone, which is not heard by anyone standing in the intermediate spaces.

There is a square room with an elliptical ceiling, on the ground floor of the Conservatoire des Arts et Métiers, in Paris, which presents this phenomenon in a remarkable degree when persons stand in the two foci of the ellipse.

It is not merely by solid surfaces, such as walls, rocks, ships' sails, etc., that sound is reflected. It is also reflected by clouds, and it has even been shown by direct experiment that a sound in passing from a gaseous medium of one density into another is reflected at the surface as it would be against a solid surface.

In the whispering gallery of St. Paul's, the faintest sound is thus conveyed from one side to the other of the dome, but is not heard at any intermediate points. Placing himself close to the upper wall of the Colosseum, a circular building 130 feet in diameter, Wheatstone found a word to be repeated a great many times. A single exclamation appeared as like a peal of laughter, while the tearing of a piece of paper was like the patter of hail.

Whispering galleries are formed of smooth walls having a continuous curved form. The mouth of the speaker is presented at one point, and the ear of the hearer at another and distant point. In this case, the sound is successively reflected from one point to the other until it reaches the ear.

Different parts of the earth's surface are unequally heated by the sun, owing to the shadows of trees, evaporation of water, and other causes, so that in the atmosphere there are numerous ascending and descending currents of air of different density. Whenever a sonorous wave passes from a medium of one density into another it undergoes partial reflection, which, though not strong enough to form an echo, distinctly weakens the direct sound. This is doubtless the reason, as Humboldt remarks, why sound travels further at night than at daytime; even in the South American forests, where the animals, which are silent by day, fill the atmosphere in the night with thousands of confused sounds.

It has generally been considered that fog in the atmosphere is a great deadener of sound; it being a mixture of air and globules of water, at each of the innumerable surfaces of contact a portion of the vibration is lost. The evidence as to the influence of this property is conflicting; recent researches of Tyndall show that a white fog, or snow, or hail, are not important obstacles to the transmission of sound, but that aqueous vapour is. Experiments made on a large scale, in order to ascertain the best form of fog-signals, gave some remarkable results.

On some days which optically were quite clear, certain sounds could not be heard at a distance far inferior to that at which they could be heard even

during a thick haze. Tyndall ascribes this result to the presence in the atmosphere of aqueous vapour, which forms in the air innumerable strata that do not interfere with its optical clearness, but render it acoustically turbid, the sound being reflected by this invisible vapour just as light is by the visible cloud.

These conclusions first drawn from observations have been verified by laboratory experiments. Tyndall has shown that a medium consisting of alternate layers of light and heavy gas deadens sound, and also that a medium consisting of alternate strata of heated and ordinary air exerts a similar influence. The same is the case with an atmosphere containing the vapours of volatile liquids. So long as the continuity of air is preserved, sound has great power of passing through the interstices of solids; thus it will pass through twelve folds of a dry silk handkerchief, but is stopped by a single layer if it is wetted.

233. **Refraction of sound.**—It will be found in the sequel that *refraction* is the change of direction which light and heat experience on passing from one medium to another. It has been shown by Hajech that the laws of the refraction of sound are the same as those for light and heat: he used tubes filled with various gases and liquids, and closed by membranes; the membrane at one end was at right angles to the axis of the tube, while the other made an angle with it. When these tubes were placed in an aperture in the wall between two rooms, a sound produced in front of the tube in one room, that of a tuning-fork for instance, was heard in directions in the other varying with the nature of the substance with which the tube was filled. Accurate measurements showed that the law held that the sine of the angle of incidence and of refraction are in a constant ratio, which is equal to the ratio of the velocity of sound in the two media.

Sondhauss has confirmed the analogy of the refraction of sound waves to those of light and heat. He constructed gas lenses by cutting equal segments out of a large collodion balloon, and fastening them on the two sides of a sheet iron ring a foot in diameter, so as to form a double convex lens about 4 inches thick in the centre. This was filled with carbonic acid, and a watch was placed in the direction of the axis: the point was then sought on the other side of the lens at which the sound was most distinctly heard. It was found that when the ear was removed from the axis, the sound was scarcely perceptible; but that at a certain point on the axial line it was very distinctly heard. Consequently, the sound waves in passing from the lens had converged towards the axis, their direction had been changed; in other words, they had been refracted.

The refraction of sound may be easily demonstrated by means of one of the very thin india-rubber balloons used as children's toys, inflated by carbonic acid. If the balloon be filled with hydrogen, no focus is detected; it acts like a concave lens, and the divergence of the rays is increased, instead of their being converged to the ear.

234. **Speaking trumpet. War Trumpet.**—These instruments are based both on the reflection of sound and on its conductivity in tubes.

The *speaking trumpet*, as its name implies, is used to render the voice audible at great distances. It consists of a slightly conical tin or brass tube (fig. 186), very much wider at one end (which is called the *bell*), and provided

with a mouthpiece at the other. The larger the dimensions of this instrument the greater is the distance at which the voice is heard. Its action is usually ascribed to the successive reflections of sonorous waves from the sides of the



Fig. 186.

tube, by which the waves tend more and more to pass in a direction parallel to the axis of the instrument. It has, however, been objected to this explanation, that the sounds emitted by the speaking trumpet are not stronger solely in the direction of the axis, but in all directions, that the bell would not tend to produce parallelism in the sonorous wave, whereas it certainly exerts considerable influence in strengthening the sound. It must be said that no satisfactory explanation has been given of the effect of the bell.

The *ear trumpet* is used by persons who are hard of hearing. It is essentially an inverted speaking trumpet, and consists of a conical metallic tube, one of whose extremities terminating in a *bell*, receives the sound, while the other end is introduced into the ear. This instrument is the reverse of the speaking trumpet. The bell serves as a mouthpiece; that is, it receives the sound coming from the mouth of the person who speaks. These sounds are transmitted by a series of reflections to the interior of the trumpet, so that the waves which would become greatly developed, are concentrated on the auditory apparatus, and produce a far greater effect than divergent waves would have done.

235. **Stethoscope.**—One of the most useful applications of acoustical principles is the stethoscope. Figs. 187, 188 represent an improved form of this instrument devised by König. Two sheets of caoutchouc, *c* and *a*, are fixed to the circular edge of a hollow metal hemisphere; the edge is provided with a stopcock, so that the sheets can be inflated, and then present the ap-



Fig. 187.

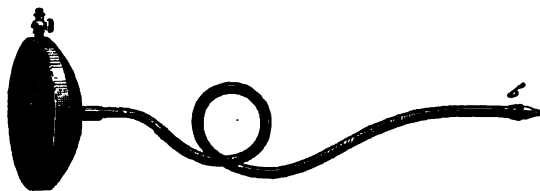

Fig. 188.

pearance of a double convex lens, as represented in section in fig. 187. To a tubulure on the hemisphere is fixed a caoutchouc tube terminated by horn or ivory, *b*, which is placed in the ear (fig. 188).

When the membrane of the stethoscope is applied to the chest of a sick person the beating of the heart and the sounds of respiration are transmitted

to the air in the chamber *ca*, and from thence to the ear by means of the flexible tube. If several tubes are fixed to the instrument as many observers may simultaneously auscultate the same patient.

## CHAPTER II.

### MEASUREMENT OF THE NUMBER OF VIBRATIONS.

236. **Savart's apparatus.**—*Savart's toothed wheel*, so called from the name of its inventor, is an apparatus by which the absolute number of vibrations corresponding to a given note can be determined. It consists of a solid oak frame in which there are two wheels, A and B (fig. 188); the larger

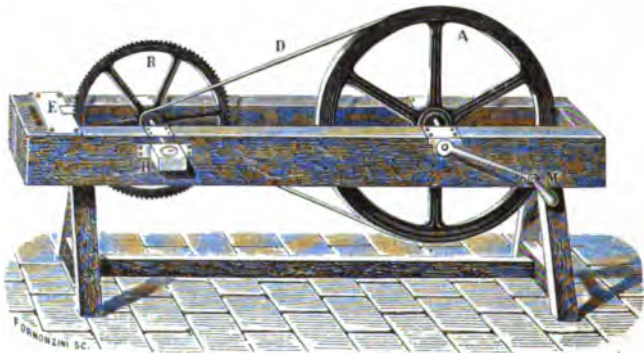

Fig. 189.

wheel, A, is connected with the toothed wheel by means of a strap and a multiplying wheel, thereby causing the toothed wheel to revolve with great velocity; a card, E, is fixed on the frame, and, in revolving, the toothed wheel strikes against it, and causes it to vibrate. The card being struck by each tooth, makes as many vibrations as there are teeth. At the side of the apparatus there is an indicator, H, which gives the number of revolutions of the wheel, and consequently the number of vibrations in a given time.

When the wheel is moved slowly, the separate shocks against the card are distinctly heard; but if the velocity is gradually increased, the sound becomes higher and higher. Having obtained the sound whose number of vibrations is to be determined, the revolution of the wheel is continued with the same velocity for a certain number of seconds. The number of turns of the toothed wheel B is then read off on the indicator, and this multiplied by the number of teeth in the wheel gives the total number of vibrations. Dividing this by the corresponding number of seconds, the quotient gives the number of vibrations per second for the given sound.

237. **Syren.**—The *syren* is an apparatus which, like Savart's wheel, is used to measure the number of vibrations of a body in a given time. The

name 'syren' was given to it by its inventor, Cagniard Latour, because it yields sounds under water.

It is made entirely of brass. Fig. 190 represents it fixed on the table of a bellows, by which a continuous current of air can be sent through it. Figs. 191 and 192 show the internal details. The lower part consists of a cylindrical box, O, closed by a fixed plate, B. On this plate A, moving with the rod, T, rests, to which is fixed a disc, A, moving with the rod. In the plate B there are equidistant circular holes, and in the disc A are an equal number of holes of the same size, and the same distance from the centre as those of the plate. These holes are not perpendicular to the disc; they are all inclined to the same extent in the same direction in the plate, and are inclined to the same extent in the opposite direction in the disc, so that when they are opposite

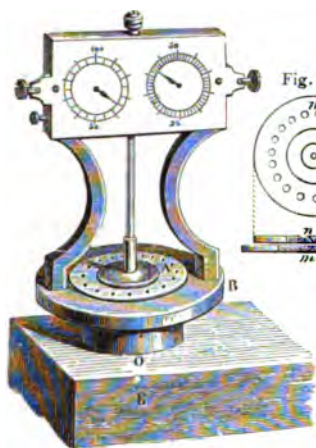

Fig. 190.

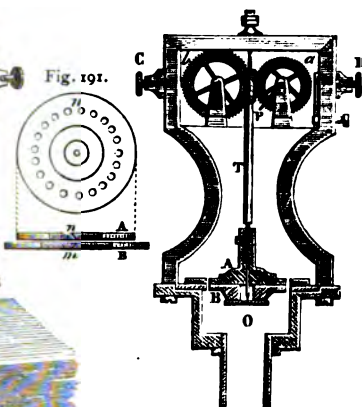

Fig. 192.

each other they have the appearance represented in *mn*, fig. 191. Consequently, when a current of air from the bellows reaches the hole *m*, it strikes obliquely against the sides of the hole *n*, and imparts to the disc A a rotatory motion in the direction *nA*.

For the sake of simplicity, let us first suppose that in the moveable disc A there are eighteen holes, and in the fixed plate B only one, which faces one of the upper holes. The wind from the bellows striking against the sides of the latter, the moveable disc begins to rotate, and the space between two of its consecutive holes closes the hole in the lower plate. But as the disc continues to turn from its acquired velocity, two holes are again opposite each other, a new impulse is produced, and so on. During a complete revolution of the disc the lower hole is eighteen times open and eighteen times closed. A series of effluxes and stoppages is thus produced, which makes the air vibrate, and ultimately produces a sound when the successive impulses are sufficiently rapid. If the fixed plate, like the moving disc, had eighteen holes, each hole would separately produce the same effect as a



separate one, the sound would be eighteen times as intense, but the number of vibrations would not be increased.

In order to know the number of vibrations corresponding to the sound produced, it is necessary to know the number of revolutions of the disc A in a second. For this purpose an endless screw on the rod T transmits the motion to a wheel, *a*, with 100 teeth. On this wheel, which moves by one tooth for every turn of the disc, there is a catch, P, which at each complete revolution moves one tooth of a second wheel, *b* (fig. 192). On the axis of these wheels there are two needles, which move round dials represented in fig. 190. One of these indices gives the number of turns of the disc A, the other the number of hundreds of turns. By means of two screws, D and C, the wheel *a* can be uncoupled from the endless screw.

Since the sound rises in proportion to the velocity of the disc A, the wind is forced until the desired sound is produced. The same current is kept up for a certain time, two minutes for example, and the number of turns read off. This number multiplied by 18, and divided by 120, indicates the number of vibrations in a second.

With the same velocity the syren gives the same sound in air as in water; the same is the case with all gases; and it appears, therefore, that any given sound depends on the number of vibrations, and not on the nature of the sounding body.

The buzzing and humming noise of certain insects is not vocal, but is produced by very rapid flapping of the wings against the air or the body. The syren has been ingeniously applied to count the velocity of the undulations thus produced, which is effected by bringing it into unison with the sound. It has thus been found that the wings of a gnat flap at the rate of 15,000 times in a second.

238. **Bellows.**—In acoustics a *bellows* is an apparatus by which wind instruments, such as the syren and organ pipes, are worked. Between the four legs of a table there is a pair of bellows, S (fig. 193), which is worked by means of a pedal, P. D is a reservoir of flexible leather, in which is stored the air forced in by the bellows. If this reservoir is pressed by means of weights on a rod, T, moved by the hand, the air is driven through a pipe, E, into a chest, C, fixed on the table. In this chest there are small holes closed by leather valves, which can be opened by pressing on keys in front of the box. The syren or sounding pipe is placed in one of these holes.

239. **Limit of perceptible sounds.**—Before Savart's researches, physicists assumed that the ear could not perceive a sound when the number of vibrations was below 16 for deep sounds, or above 9,000 for acute sounds. But he showed that these limits were too close, and that the faculty of perceiving sounds depends rather on their intensity than on their height; so that when extremely acute sounds are not heard, it arises from the fact that they have not been produced with sufficient intensity to affect the organ of hearing.

By increasing the diameter of the toothed wheel, and consequently the amplitude and intensity of the vibrations, Savart pushed the limit of acute sounds to 24,000 vibrations in a second.

For deep sounds, he substituted for the toothed wheel an iron bar about two feet long, which revolved on a horizontal axis between two thin wooden plates, about 0.08 of an inch from the bar. As often as the bar passed, a

grave sound was produced, due to the displacement of the air. As the motion became accelerated, the sound became continuous, very grave and

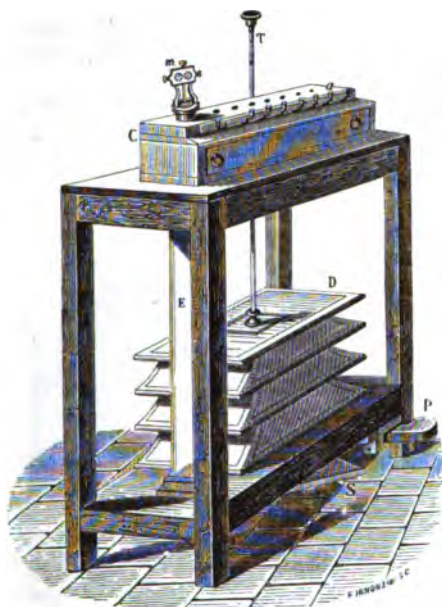

Fig. 193.

deafening. By this means Savart found, that with 7 to 8 vibrations in a second, the ear perceived a distinct but very deep sound.

M. Despretz, however, who has investigated the same subject, disputes Savart's results as to the limits of deep sounds, and considers that no sound is audible that is made by less than 16 vibrations per second. Helmholtz holds that the perception of a sound begins at 30 vibrations, and only has a definite musical value when the number is more than 40. Below 30 the impression of a number of separate beats is produced. On the other hand acute sounds are audible up to those corresponding to 38,000 vibrations in a second.

The discordant results obtained by these and other observers for the limit of audibility of higher notes are no doubt due to the circumstance that different observers have different capacities for the perception of sounds. Preyer has investigated this subject by means of experimental methods of greater precision than any that have hitherto been applied for this purpose. The minimum limit for the normal ear he found to lie between 16 and 24 single vibrations in a second; the maximum limit reached 41,000; but many persons with average powers of hearing were found to be absolutely deaf to tones of 16,000, 12,000, or even fewer vibrations.

240. **Duhamel's graphic method.**—When the syren or Savart's wheel is used to determine the exact number of vibrations corresponding to a given

sound, it is necessary to bring the sound which they produce into unison with the given sound, and this cannot be done exactly unless the experimenter have a practised ear. M. Duhamel's graphic method is very simple and exact, and free from this difficulty. It consists in fixing a fine point to the body emitting the sound, and causing it to trace the vibrations on a properly prepared surface.

The apparatus consists of a wood or metal cylinder, A, fig. 194, fixed to a vertical axis, O, and turned by a handle. The lower part of the axis is a

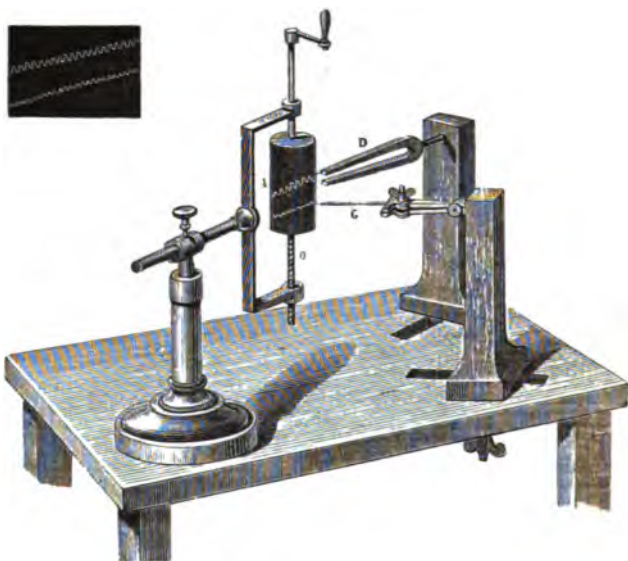

Fig. 194.

screw working in a fixed nut, so that, according as the handle is turned from left to right, or from right to left, the cylinder is raised or depressed. Round the cylinder is rolled a sheet of paper covered with an inadhesive film of lampblack. On this film the vibrations register themselves. This is effected as follows: Suppose the body emitting the note to be a steel rod. It is held firmly at one end, and carries at the other a fine point which grazes the surfaces of the cylinder. If the rod is made to vibrate and the cylinder is at rest, the point would describe a short line; but if the cylinder is turned, the point produces an *undulating trace*, containing as many undulations as the point has made vibrations. Consequently the number of vibrations can be counted. It remains only to determine the time in which the vibrations were made.

There are several ways of doing this. The simplest is to compare the curve traced by the vibrating rod with that traced by a tuning-fork (246), which gives a known number of vibrations per second—for example, 500. One prong of the fork is furnished with a point, which is placed in contact with the lampblack. The fork and the rod are then set vibrating together,

and each produces its own undulating trace. When the paper is unrolled, it is easy, by counting the number of vibrations each has made in the same distance, to determine the number of vibrations made per second by the elastic rod. Suppose, for instance, that the tuning-fork made 150 vibrations, while the rod made 165 vibrations. Now we already know that the tuning-fork makes one vibration in the  $\frac{1}{500}$  part of a second, and therefore 150 vibrations in  $\frac{150}{500}$  of a second. But in the same time the rod makes 165 vibrations; therefore it makes one vibration in the  $\frac{150}{500 \times 165}$  of a second, and hence it makes per second  $\frac{500 \times 165}{150}$  or 550 vibrations.

---

### CHAPTER III.

#### THE PHYSICAL THEORY OF MUSIC.

241. **Properties of musical tones.**—A simple musical tone results from a continuous rapid isochronous vibration, provided the number of the vibrations falls within the very wide limits mentioned in the last chapter (239). Musical tones are in most cases compound. The distinction between a simple and a compound musical tone will be explained later in the chapter. The tone yielded by a tuning-fork furnished with a proper resonance box is *simple*; that yielded by a wide-stopped organ pipe, or by a flute, is *nearly simple*; that yielded by a musical string is *compound*.

Musical tones have three leading qualities, namely, *pitch*, *intensity*, and *timbre* or *colour*.

i. The *pitch* of a musical tone is determined by the number of vibrations per second yielded by the body producing the tone.

ii. The *intensity* of the tone depends on the *extent* of the vibrations. It is greater when the extent is greater, and less when it is less. It is, in fact, proportional to the square of the extent or amplitude of the vibrations which produce the tone.

iii. The *timbre* or *stamp* is that peculiar quality of tone which distinguishes a note when sounded on one instrument from the same note when sounded on another. Thus when the C of the treble stave is sounded on a violin, and on a flute, the two notes will have the same pitch, that is, are produced by the same number of vibrations per second, and they may have the same intensity, and yet the two tones will have very distinct qualities, that is, their timbre is different. The cause of the peculiar timbre of tones will be considered later in the chapter.

242. **Musical intervals.**—Let us suppose that a musical tone, which for the sake of future reference we will denote by the letter C, is produced by  $m$  vibrations per second; and let us further suppose that any other musical tone, X, is produced by  $n$  vibrations per second,  $n$  being greater than  $m$ ; then the interval from the note C to the note X is the ratio  $n$ ;  $m$ , the interval between two notes, being obtained by *division*, not by *subtraction*. Although two or more tones may be separately musical, it by no means follows that when sounded together they produce a pleasurable sensation. On the con-

trary, unless they are *concordant*, the result is harsh, and usually displeasing. We have, therefore, to enquire what *notes* are fit to be sounded together. Now when musical tones are compared, it is found that if they are separated by an interval of 2 : 1, 4 : 1, etc., they so closely resemble one another that they may for most purposes of music be considered as the same tone. Thus, suppose  $c$  to stand for a musical note produced by  $2m$  vibrations per second, then  $C$  and  $c$  so closely resemble one another as to be called in music by the same name. The interval from  $C$  to  $c$  is called an *octave*, and  $c$  is said to be an *octave* above  $C$ , and conversely  $C$  an octave below  $c$ . If we now consider musical sounds that do not differ by an octave, it is found that if we take three notes,  $X$ ,  $Y$ , and  $Z$ , resulting respectively from  $p$ ,  $q$ , and  $r$  vibrations per second, these three notes when sounded together will be concordant if the ratio of  $p : q : r$  equals 4 : 5 : 6. Three such notes form a *harmonic triad*, and if sounded with a fourth note, which is the octave of  $X$ , constitute what is called in music a *major chord*. Any of the notes of a chord may be altered by one or more octaves without changing its distinctive character; for instance,  $C$ ,  $E$ ,  $G$ , and  $c$  are a chord, and  $C$ ,  $c$ ,  $e$ ,  $g$  form the same chord.

If, however, the ratio  $p : q : r$  equals 10 : 12 : 15, the three sounds are slightly dissonant, but not so much so as to disqualify them from producing a pleasing sensation, at least under certain circumstances. When these three notes and the octave to the lower are sounded together they constitute what in music is called a *minor chord*.

243. **The musical scale.**—The series of sounds which connects a given note  $C$ , with its octave  $c$ , is called the *diatonic scale* or *gamut*. The notes composing it are indicated by the letters  $C$ ,  $D$ ,  $E$ ,  $F$ ,  $G$ ,  $A$ ,  $B$ . The scale is then continued by taking the octaves of these notes, namely,  $c$ ,  $d$ ,  $e$ ,  $f$ ,  $g$ ,  $a$ ,  $b$ , and again the octaves of these last, and so on.

The notes are also known by names, viz., *do* or *ut*, *re*, *mi*, *fa*, *sol*, *la*, *si*, *do*. The relations existing between the notes are these:— $C$ ,  $E$ ,  $G$  form a major triad,  $G$ ,  $B$ ,  $d$  form a major triad, and  $F$ ,  $A$ ,  $c$  form a major triad.  $C$ ,  $G$ , and  $F$  have, for this reason, special names, being called respectively the *tonic dominant* and *sub-dominant*, and the three triads the *tonic*, *dominant*, and *sub-dominant* triads or chords respectively. Consequently the numerical relations between the notes of the scale will be given by the three proportions—

$$C : E : G :: 4 : 5 : 6$$

$$G : B : 2D :: 4 : 5 : 6$$

$$F : A : 2C :: 4 : 5 : 6$$

Hence if  $m$  denotes the number of double vibrations corresponding to the note  $C$ , the number of vibrations corresponding to the remaining notes will be given by the following table—

<i>do</i>	<i>re</i>	<i>mi</i>	<i>fa</i>	<i>sol</i>	<i>la</i>	<i>si</i>	<i>do</i>
$C$	$D$	$E$	$F$	$G$	$A$	$B$	$c$
$m$	$\frac{9}{8}m$	$\frac{5}{4}m$	$\frac{4}{3}m$	$\frac{3}{2}m$	$\frac{5}{3}m$	$\frac{15}{8}m$	$2m$

The intervals between the successive notes being respectively—

C to D	D to E	E to F	F to G	G to A	A to B	B to c
$\frac{9}{8}$	$\frac{10}{9}$	$\frac{16}{15}$	$\frac{9}{8}$	$\frac{10}{9}$	$\frac{9}{8}$	$\frac{15}{13}$

It will be observed here that there are three kinds of intervals,  $\frac{9}{8}$ ,  $\frac{10}{9}$ , and  $\frac{16}{15}$ ; of these the two former are called a *tone*, the last a *semitone* because it is about half as great as the interval of a tone. The two tones, however, are not identical, but differ by an interval of  $\frac{91}{80}$ , which is called a *comma*. Two notes which differ by a *comma* can be readily distinguished by an educated ear. The interval between the tonic and any note is denominated by the position of the latter note in the scale; thus the interval from C to G is a *fifth*. The scale we have now considered is called the *major* scale, as being formed of *major* triads. If the minor triad were substituted for the major, a scale would be formed that could be strictly called a *minor* scale. As scales are usually written, however, the *ascending* scale is so formed that the tonic bears a minor triad, the dominant and sub-dominant bear *major* triads, while in the *descending* scale they all bear *minor* triads. Practically, in musical composition, the dominant triad is always *major*. If the ratios given above are examined, it will be found that in the major scale the interval from C to E equals  $\frac{5}{4}$ , while in the minor scale it equals  $\frac{9}{8}$ . The former interval is called a *major* third, the latter a *minor* third. Hence the major third exceeds the minor third by an interval of  $\frac{25}{24}$ . This interval is called a *semitone*, though very different from the interval above called by that name.

A complete discussion of the number of notes, and the intervals between them, will be found in an article by Mr. Ellis, in vol. xiii. of the *Proceedings of the Royal Society* (p. 93), 'On a perfect Musical Scale.'

244. **On semitones and on scales with different key notes.**—It will be seen from the last article that the term 'semitone' does not denote a constant interval, being in one case equivalent to  $\frac{16}{15}$  and in another to  $\frac{25}{24}$ . It is found convenient for the purposes of music to introduce notes intermediate to the seven notes of the gamut; this is done by increasing or diminishing those notes by an interval of  $\frac{25}{24}$ . When a note (say C) is increased by this interval, it is said to be *sharpened*, and is denoted by the symbol C $\sharp$ , called 'C sharp'; that is, C $\sharp$  + C =  $\frac{25}{24}$ . When it is decreased by the same interval, it is said to be *flattened*, and is represented thus—B $\flat$ , called 'B flat'; that is, B + B $\flat$  =  $\frac{25}{24}$ . If the effect of this be examined, it will be found that the number of notes in the scale from C up to c has been increased from seven to twenty-one notes, all of which can be easily distinguished by the ear. Thus reckoning C to equal 1, we have—

C	C $\sharp$	D $\flat$	D	D $\sharp$	E $\flat$	E	etc.
1	$\frac{25}{24}$	$\frac{27}{25}$	$\frac{9}{8}$	$\frac{75}{64}$	$\frac{6}{5}$	$\frac{5}{4}$	etc.

Hitherto we have made the note C the tonic or *key note*. Any other of the twenty-one distinct notes above mentioned, e.g. G, or F, or C $\sharp$ , etc., may be made the key note, and a scale of notes constructed with reference to it. This will be found to give rise in each case to a series of notes, some of which are identical with those contained in the series of which C is the key note, but most of them different. And of course the same would be true for the minor scale as well as for the major scale, and indeed for other scales which may be constructed by means of the fundamental triads.

245. **On musical temperament.**—The number of notes that arise from the construction of the scales described in the last article is so great as to

prove quite unmanageable in the practice of music ; and particularly for music designed for instruments with fixed notes, such as the pianoforte or harp. Accordingly, it becomes practically important to reduce the number of notes, which is done by slightly altering their just proportions. This process is called *temperament*. By tempering the notes, however, more or less dissonance is introduced, and accordingly several different systems of temperament have been devised for rendering this dissonance as slight as possible. The system usually adopted is called the system of *equal temperament*. It consists in the substitution between C and c of eleven notes at equal intervals, each interval being, of course, the twelfth root of 2, or 1.05946. By this means the distinction between the semitones is abolished, so that, for example, C $\sharp$  and D $\flat$  become the same note. The scale of twelve notes thus formed is called the *chromatic scale*. It of course follows that major triads become slightly dissonant. Thus, in the diatonic scale, if we reckon C to be 1, E is denoted by 1.25000, and G by 1.50000. On the system of equal temperament, if C is denoted by 1, E is denoted by 1.25992, and G by 1.49831.

If individual intervals are made pure while the errors are distributed over the others, such a system is called that of *unequal temperament*. Such a one is *Kirnberger's*, in which nine of the tones are pure.

Although the system of equal temperament has the advantage of affording, with as small a number of notes as possible, the greatest variety of tones, yet it has the disadvantage that no chord of an equally-tempered instrument, such as the piano, is quite pure. And as musical education mostly has its basis on the piano, even singers and

instrumentalists usually give equally-tempered intervals. Only in the case of string quartet players, who have freed themselves from school rules, and in that of vocal quartet singers, who sing much without accompaniment, does the natural pure temperament assert itself, and thus produce the highest musical effect.

**246. The number of vibrations producing each note. The tuning-fork.**—Hitherto we have denoted the number of vibrations corresponding to the note C by  $m$ , and have not assigned any numerical value to that symbol. In the theory of music it is frequently assumed that the middle C corresponds to 256 double vibrations in a second. This is the note which, on a pianoforte of seven octaves, is produced by the white key on the left of the two black keys close to the centre of the keyboard. This number is convenient as being continually divisible by two. It is, however, arbitrary. An instrument is in tune provided the intervals between the notes are correct, when  $c$  is yielded

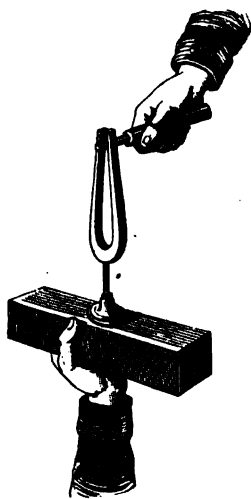

Fig. 195.

by any number of vibrations per second not differing much from 256. Moreover, two instruments are in tune with one another, if, being separately in

tune, they have any one note, for instance C, yielded by the same number of vibrations. Consequently, if two instruments have one note in common, they can then be brought into tune jointly by having their remaining notes separately adjusted with reference to the fundamental note. A *tuning-fork* or *diapason* is an instrument yielding a constant sound, and is used as a standard for tuning musical instruments. It consists of an elastic steel rod, bent as represented in fig. 195. It is made to vibrate either by drawing a bow across the ends, or by striking one of the legs against a hard body, or by rapidly separating the two prongs by means of a steel rod, as shown in the figure. The vibration produces a note which is always the same for the same tuning-fork. The note is strengthened by fixing the tuning-fork on a box open at one end, called a *resonance box*.

The standard tuning-fork in any country represents its accepted concert pitch.

It has been remarked for some years that not only has the pitch of the tuning-fork been getting higher in the large theatres of Europe, but also that it is not the same in London, Paris, Berlin, Vienna, Milan, etc. This is a source of great inconvenience both to composers and singers, and a commission was appointed in 1859 to establish in France a tuning-fork of uniform pitch, and to prepare a standard which would serve as an invariable type. In accordance with the recommendations of that body, a *normal tuning-fork* has been established, which is compulsory on all musical establishments in France, and a standard has been deposited in the Conservatory of Music in Paris. It performs 437.5 double vibrations per second, and gives the standard note *a* or *la*, or the *a* in the treble stave (247). Consequently, with reference to this standard, the middle *c* or *do* would result from 261 double vibrations per second.

In England a committee, appointed by the Society of Arts, recommended that a standard tuning-fork should be one constructed to yield 528 double vibrations in a second and that this should represent *c'* in the treble stave. This number has the advantage of being divisible by 2 down to 33, and is in fact the same as the normal tuning-fork adopted in Stuttgart in 1834, which makes 440 vibrations in the second, and, like the French one, corresponds to *a* in the same stave.

**247. Musical notation. Musical range.**—It is convenient to have some means of at once naming any particular note in the whole range of musical sounds other than by stating its number of vibrations. Perhaps a convenient practice is to call the octave, of which the C is produced by an eight-foot organ pipe, by the capital letters C, D, E, F, G, A, B; the next higher octave by the corresponding small letters, *c, d, e, f, g, a, b*, and to designate the octaves higher than this by the index placed over the letter thus, *c', d', e', f', g', a', b'*, and the higher series in a similar manner. The same principle may be applied to the notes below C; thus the octave below C is *C<sub>11</sub>*, and the next lower one *C<sub>10</sub>*.

Thus we have the series

$$C_{11}, C, C, c, c', c'', c''', c^{iv}.$$



In musical writing the notes are expressed by signs which indicate the

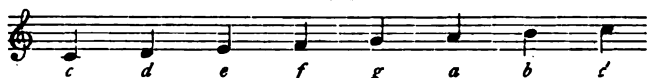

length of time during which the note is to be played or sung, and are written on a series of lines called a *stave*. Thus

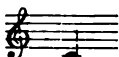

stands for the octave in the treble clef; of which the top note is the standard  $c'$  and the bottom is the middle  $c$ . Where the five lines are insufficient they are continued above and below the staff by what are called *ledger lines*. In order to avoid confusion, a bass clef is used for the lower notes; and it

may be remarked that  and  stand for the same note

(246) which is the middle  $c$ .

The deepest note of orchestral instruments is the E, of the double bass which makes  $41\frac{1}{2}$  vibrations, taking the key note as making 440 vibrations in a minute. Some organs and pianofortes go as low as C, with 33 vibrations in a minute, some grand pianos even as low as A, with  $27\frac{1}{2}$  vibrations. But the musical character of all these notes below E, is imperfect, for we are near the limit at which the ear can combine the separate vibrations to a musical note (239). These notes can only be used musically with their next higher octave, to which they impart a certain character of depth and richness.

In the other direction, pianofortes go to  $a^v$  with 3520 or even  $c'$  with 4224 vibrations in a second. The highest note of the orchestra is probably the  $a^v$  of the piccolo flute which makes 4752 vibrations. And although the ear can distinguish sounds which are still higher, they have no longer a pleasurable character. And while the notes which are distinguishable by the ear, range between 16 and 38,000 vibrations, or 11 octaves; those which are musically available range from about 40 to 4000 vibrations, or within 7 octaves.

**248. Wave length of a given note.**—Knowing the number of vibrations which a sounding body makes in a second, the corresponding wave length is easily calculated. For since sound travels at about 1120 feet in a second, if a body only made one vibration in a second its wave length would be 1120 feet; if it made two, the wave length would be half of 1120 feet; if it made three, the third, and so on—that is, that *the wave length of any note is the quotient obtained by dividing the velocity of sound by the number of vibrations*; and this whatever the height of the sound, since the velocity is the same for high and low notes.

Hence, calling  $v$  the velocity of sound,  $l$  the wave length,  $n$  the number of vibrations in a second, we have  $v = ln$ , from which  $n = \frac{v}{l}$ , that is, that the number of vibrations is inversely as the wave length.

**249. On compound musical tones and harmonics.**—When any given note (say C) is sounded on most musical instruments, not that tone alone is produced, but a series of tones, each being of less intensity than the one preceding it. If C, which may be called the *primary* tone, is denoted by unity, the whole series is given by the numbers 1, 2, 3, 4, 5, 6, 7, etc.; in other words, first the primary C is sounded, then its octave becomes audible

then the fifth to that octave, then the second octave, then the third, fifth, and a note between the sixth and seventh to the second octave, and so on. These secondary tones are called the *harmonics* of the primary *tone*. Though feeble in comparison with the primary tone, they may, with a little practice, be heard, when the primary tone is produced on most musical instruments; when, for instance, one of the lower notes is sounded on the pianoforte.

250. **Helmholtz's analysis of sound.**—For the purpose of experimentally proving the presence of the harmonics as distinct tones, Professor Helmholtz devised an instrument which he called a *resonance globe*. The principle of its construction is this: A volume of air contained in an open vessel, for example a bottle, when caused to vibrate, tends to yield a certain note, and consequently, when that note is sounded in its neighbourhood, to strengthen



Fig. 197.

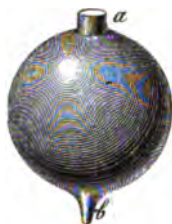

Fig. 196.

it (222). A resonance globe (fig. 196) is a glass globe furnished with two openings, one of which, *a*, is turned towards the origin of sound, and the other, *b*, by means of an indiarubber tube, is applied to the ear. If the tone proper to the resonance globe exists among the harmonics of the compound tone that is sounded it is strengthened by the globe, and thereby rendered distinctly audible. Further, other things being the same, the note proper to a given globe depends on the diameter of the globe and that of the uncovered opening. Consequently, by means of a series of such globes, the whole series of harmonics in a given compound tone can be rendered distinctly audible, and their existence put beyond a doubt.

König, the eminent acoustical instrument maker, has made an important modification in the resonance globe, to which he has given the form represented in fig. 197. The resonator is cylindrical, and the end which receives the sound can be drawn out, so that the volume may be increased at pleasure. As the sound thereby becomes deeper, the same resonator may be tuned to a variety of notes. On the tubulure fits a caoutchouc tube by which the vibrations may be transmitted in any direction.

251. **König's apparatus for the analysis of sound.**—As the successive application to the ear of various resonators is both slow and tedious, König has devised a remarkable apparatus in which a series of resonators act on manometric flames (281); the sounds thus, as it were, become visible, and may be shown to a large auditory.

It consists of an iron frame (fig. 198) on which are fixed in two parallel lines fourteen resonators tuned so as to give the notes from *F*, to *c''*, that is to say, four octaves and a half; or notes of which the highest give the lower harmonics of the primary. On the right is a chamber, *C*, which is supplied

with coal gas by the caoutchouc tube, D, and on which are placed eight gas jets, each provided with a manometric capsule (281). Each jet is connected with the chamber C by a special caoutchouc tube, while behind the apparatus a second tube connects the same jet to one of the resonators.

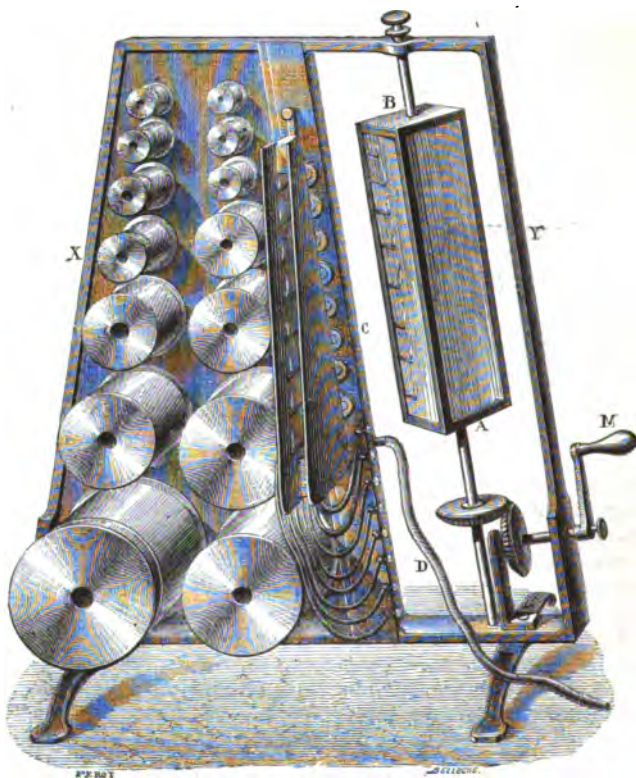

Fig. 198.

On the right of the jets is a system of rotating mirrors identical with that described in article 281.

These details being understood, suppose the largest resonator on the right tuned to resound with the note 1, and seven others with the harmonics of this note. Let the sound 1 be produced in part of this apparatus; if it is simple, the lower resonator alone answers, and the corresponding flame is alone dentated; but if the fundamental note is accompanied by one or more of its harmonics, the corresponding resonators speak at the same time, which is recognised by the dentation of their flames; and thus the constituents of each sound may be detected.

252. **Synthesis of sounds.**—Not only has Helmholtz succeeded in decomposing sounds into their constituents; he has verified the result of his

analysis by performing the reverse operation, the synthesis ; that is, he has reproduced a given sound by combining the individual sounds of which his resonators had shown that it was composed. The apparatus which he used for this purpose consists of eleven tuning-forks, the first of which yields the fundamental note of 256 vibrations, or C, nine others its harmonics, while the eleventh serves as make and break to cause the diapasons to vibrate by means of electro-magnets. Each diapason has a special electro-magnet, and moreover a resonator, which strengthens it.

All these diapasons and their accessories are arranged in parallel lines of five (fig. 199), the first comprising the fundamental note and its uneven

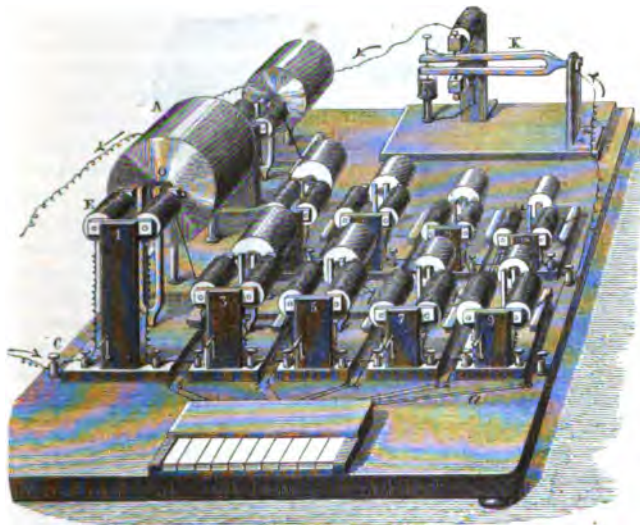

Fig. 199.

harmonics, 3, 5, 7, and 9 ; the second the even harmonics, 2, 4, 6, 8 and 10 ; beyond, there is the diapason break K arranged horizontally. One of its prongs is provided with a platinum point which grazes the surface of mercury contained in a small cup, the bottom of which is connected, by a copper wire, with an electro-magnet placed in front of the diapason.

The apparatus being thus arranged, a wire from a voltaic battery is connected with the binding screw, *c*, and this with the electro-magnet, *E* ; which in turn is connected with those of the nine following diapasons, and then with the diapason K itself. So long as the diapason does not vibrate, the current does not pass, for the platinum point does not dip in the mercury cup which is connected with the other pole of the battery. But when the diapason is made to vibrate by means of a bow, the current passes. Owing to their elasticity, the limbs of the tuning-fork soon revert to their original position, the point is no longer in the mercury, the current is broken, and so on at each double vibration of the diapason. This intermittence of the

current being transmitted to all the other electro-magnets, they are alternately active and inactive. Hence they communicate to all the diapasons by their attraction the same number of vibrations. This is the case with the diapason 1, which is tuned in unison with the diapason break; but the diapason 3, being tuned to make three times as many vibrations, makes three vibrations at each break of the current; that is to say, the electro-magnet only attracts it at every third vibration; in like manner, diapason *b* only receives a fresh impulse every five vibrations, and so on.

The following is the working of the apparatus. The resonator of each diapason is closed by a clapper *O* (fig. 200), so that the sounds made by the

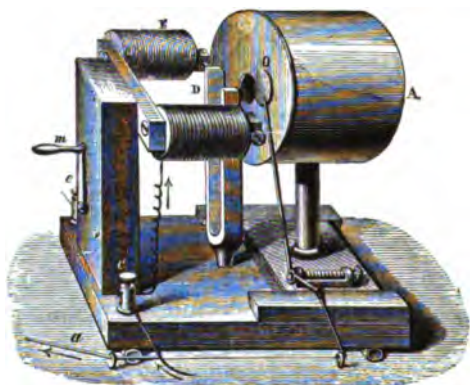

Fig. 200.

diapasons are scarcely perceptible when the clappers are lowered. Each of these is fixed to the end of a bent lever, the shorter arm of which is worked by a cord  $\alpha$ , which is connected with one of the keys of a keyboard placed in front of the apparatus (fig. 198). When a key is depressed, the cord moves the lever, which raises the clapper, and the resonator then acts by strengthening its diapason. Hence by depressing any keys, we may add to the fundamental sounds any of the nine primary harmonics, and thus reproduce the sounds, the composition of which has been determined by analysis. Thus by depressing all the keys at once we obtain the sound of an open pipe in unison with the deepest diapason. By depressing the key of the fundamental notes and those of its uneven harmonics, we obtain the sound of a closed pipe.

253. **Results of Helmholtz's researches.**—By both his analytical and synthetical investigations into sounds of the most kinds, those from various musical instruments, the human voice, and even noises, Helmholtz has fully succeeded in explaining the different *timbre* or quality of sounds. It is due to the different intensities of the harmonics which accompany the primary tones of these sounds. The leading results of these researches into the colour of sounds may be thus stated:—

i. Simple tones, as those produced by a tuning-fork with a resonance box,

and by wide covered pipes, are soft and agreeable without any roughness, but weak, and in the deeper notes dull.

ii. Musical sounds accompanied by a series of harmonics, say up to the sixth, in moderate strength are full and musical. In comparison with simple tones they are grander, richer, and more sonorous. Such are the sounds of open organ pipes, of the pianoforte, etc.

iii. If only the uneven harmonics are present, as in the case of narrow covered pipes, of pianoforte strings struck in the middle, clarionets, etc., the sound becomes indistinct; and when a greater number of harmonics are audible, the sound acquires a nasal character.

iv. If the harmonics beyond the sixth and seventh are very distinct, the sound becomes sharp and rough. If less strong, the harmonics are not prejudicial to the musical usefulness of the notes. On the contrary, they are useful as imparting character and expression to the music. Of this kind are most stringed instruments, and most pipes furnished with tongues, etc. Sounds in which harmonics are particularly strong acquire thereby a peculiarly penetrating character; such are those yielded by brass instruments.

v. To form a given vowel sound one or more characteristic notes which are always the same must be added. These change with the syllable pronounced, but depend neither on the height of the note, nor on the person who emits them.

A popular but adequate account of Helmholtz's principal results will be found in Helmholtz's 'Popular Scientific Lectures,' Longmans, 1873.

254. **Production and perception of sounds.**—Vocal sounds originate in the larynx in consequence of air being forced through a slit formed of two membranes called the *vocal chords*. These can be tightened or relaxed by means of certain muscles, and thus high or low notes can be produced. The notes produced by men are deeper than those of women or boys, because in them the larynx is longer and the vocal chords larger and thicker; hence, though equally elastic, they vibrate less swiftly. The vocal chords are 18 mm. long in men, and 12 mm. long in women. Chest notes are due to the fact that the whole membrane vibrates, while the falsetto is produced by a vibration of the extreme edges only. The ordinary compass of the voice is within two octaves, though this is exceeded by some celebrated singers. Catalini, for instance, is said to have had a range of  $3\frac{1}{2}$  octaves.

The wave length of the sounds emitted by a man's voice in ordinary conversation is from 8 feet to 12 feet, and that of women's voice is from 2 feet to 4 feet, in a second.

The sound of the human voice is very complex and rich in harmonics, for the mouth and the various cavities opening into the mouth act as resonators; as the note changes with their extent, with the degree to which the mouth is opened and the shape given to it, certain harmonics are strengthened or not, and thus the voice acquires different timbre.

Without giving an account of the anatomy of the ear we may state succinctly how Helmholtz explains the perception by the ear of the most complicated sounds.

The recent observations of M. Corti have shown that the inner membrane of the cochlea is lined with about 3000 extremely minute fibres which are the termination of the acoustic nerve. Each of these, which are called *Corti's*

*fibres*, seem to be tuned for a particular note as if it were a small resonator. It thus only vibrates in unison with this note, and is deaf for all others. Hence each simple note only causes one fibre to vibrate, while compound notes cause several: just as when we sing with a piano, only the fundamental notes and its harmonics vibrate. Hence, however complex external sounds may be, these microscopic fibres can analyse it and reveal the constituents of which it is formed.

255. **Beats.**—When two simple tones are sounded together, it is in many cases found that they alternately strengthen and weaken one another. When this is so, they are said to *beat* with one another. This may be explained as follows: Suppose AB, in fig. 201, to be a row of particles transmitting the sound: suppose the vibrations producing the one tone to be indicated by the continuous curved line; then, on the one hand, the ordinates of the different points of AB give the velocities with which those points are *simultaneously* moving, and, on the other hand, each point will have *successively* the different velocities represented by the successive ordinates. In like manner let the dotted line show the vibrations which produce the second tone. And, for the sake of distinctness, suppose the number of vibrations in a second producing the former tone to be to that producing the latter in the ratio of 3 : 2. Now let us consider any point which when at rest occupies the position N; draw the ordinate cutting the former curve in P and the latter in Q. If the tones were sounded separately, the velocity of N at a given distance produced by the former tone would be PN, and that of N at the same instant produced by the latter tone would be QN. Consequently, as they are sounded together, the actual velocity of N at the given instant is the sum of these, or  $PN + QN$ . If at the same instant we consider the point *n*, its velocity will consist of  $pn$  and  $nq$  jointly, but, as these are in opposite directions, its actual amount will be  $pn - nq$ . Hence the actual velocity resulting from the co-existence of the two tones will be indicated by the curve in fig. 202, whose ordinates equal the (algebraical) sum of the corresponding ordinates of the two curves in fig. 201; that is, if AN,  $An$ , . . . represent equal distances in

Fig. 201.

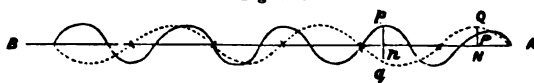
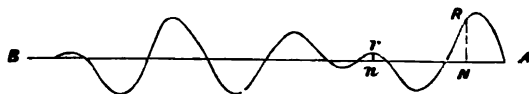

Fig. 202.



both figures, the curve is described by taking RN equal to  $PN + QN$ ,  $rn$  equal to  $pn - qn$ , and so on. This curve shows by its successive ordinates the simultaneous velocities of the different particles of AB, and the successive velocities communicated to the drum of the ear. An inspection of the figure will show that the velocities are first great, then small, then great, and so on, the drum being first moved rapidly for a short time, then for a short time nearly brought to rest, and so on. In short, the effect of the beating of tones

on the air as compared with that of a continuous tone is strictly analogous to the effect produced on the eye by a flickering as compared with a steady light.

It may be proved that when two simple tones are produced by  $m$  and  $n$  double vibrations per second, they produce  $m - n$  beats per second; thus, if C is produced by 128, and D by 144 double vibrations per second, they will on being sounded together produce 16 beats per second. It has been ascertained that the beats produced by two tones are not audible unless the ratio  $m : n$  is less than the ratio 6 : 5. Hence, in the case represented by fig. 201, though the alternations of intensity exist, they would not be audible. Also, if the tones have very different intensities, the intensity of the beat is very much disguised.

It is found that when beats are fewer than 10 per second or more than 70 per second they are disagreeable, but not to the extent of producing discord. Beats from 10 to 70 per second may be regarded as the source of all discord in music, the maximum of dissonance being attained when about 30 beats are produced in a second. For example, if  $c$  and B are sounded together, the effect is very discordant, the interval between those notes being 16 : 15, so that the beats are audible, and the number of beats per second being 16. On the other hand, if C, E, and G are sounded together there is no dissonance, but if C, E, G, B are sounded together the discord is very marked, since C produces  $c$ , which is discordant with B. It will be remarked that C, E, G is a major triad, while E, G, B is a minor triad.

A compound musical tone, being composed of simple tones represented by 1, 2, 3, 4, 5, 6, 7, etc., does not give rise to any simple tones capable of producing an audible beat up to the seventh—the sixth and seventh are the first that produce an audible beat. It is for this reason that there is no trace of roughness in a compound tone, unless the seventh harmonic be audible.

If we were to represent graphically a compound tone, we should proceed to construct a curve out of simple tones of different intensities in the same manner as fig. 202 is constructed from two simple tones of equal intensity represented by fig. 201. It is evident that the resulting curve will take different *forms* according to the presence or absence of different harmonics and their different intensities; in other words, the *colour* or timbre of the notes produced by different instruments will depend upon the *form* of the vibrations producing the sound.

By means of beats the notes emitted by two musical instruments may be brought into very accurate unison, by continuing the tuning until the beats disappear. In order to make tuning-forks produce the normal number of 440 vibrations, an auxiliary tuning-fork is used which makes 436 vibrations; each of the forks under experiment must then give 4 beats in a second, which can be controlled with very great accuracy.

**256. Combinational tones.**—Besides the beats produced when two musical notes are sounded together, there is another and distinct phenomenon, which may be thus described: Suppose two simple tones to be simultaneously produced by vibrations of finite extent, and of  $n$  and  $m$  vibrations per second. It has been shown by Helmholtz that they generate a series of other tones. The principal one of these, which may be called the *differential tone*,



is produced by  $n - m$  vibrations per second. Its intensity is generally very small, but it is distinctly audible in beats. It has been called the *grave harmonic*, as generally its pitch is much lower than that of the notes by which it is generated. It has been supposed to be caused by the beats becoming too numerous to be distinguished, and coalescing into a continuous sound, and this supposition was countenanced by the fact that its pitch is the same as the beat number. The supposition is shown to be erroneous, first, by the existence of the differential tones for intervals that do not beat, and, secondly, by the fact that, under certain circumstances, both the beats and the differential tones may be heard together.

257. **The physical constitution of musical chords.**—Let us suppose two compound tones to be sounded together, say C and G, then we obtain two series of tones each consisting of a primary and its harmonics, namely, denoting C by 4, the two series, 4, 8, 12, 16, . . . and 6, 12, 18, 24, etc. Now, if, instead of producing the two notes C and G, we had sounded the octave below C, we should have produced the series, 2, 4, 6, 8, 10, 12, 14, 16, 18, etc. It is plain that the two former series when joined differ from the last in the following respects: (a) The primary tone 2 is omitted. (b) In the case of the last series, the consecutive tones continually decrease in intensity, whereas in the two former series, 4 and 6 are of the same intensity, 8 is of lower intensity, but the two 12's will strengthen each other, and so on. (c) Certain of the harmonics of the primary 2 are omitted; for example, 10, 14, etc., do not occur in either of the two former series. In spite of these differences, however, the two compound notes affect the ear in a manner very closely resembling a single compound tone; in short, they coalesce into a single tone with an artificial colour. It may be added that in the case above taken C and G produce as a combination tone 2 (that is 6-4), so that, strictly speaking, the 2 is not wanted in the series produced by C and G, only it exists in very diminished intensity. The same explanation will apply to all possible chords; for example, in the case of the major chord, C, E, G, we have a tone of artificial colour expressed by the series of simple tones, 4, 5, 6, 8, 10, 12, 15, 16, 18, etc., together with the combination tones, 1, 1, 2. It will be remarked that in the whole of this series there are no dissonant tones introduced, except 15, 16, and 18, and this dissonance will be inappreciably slight, since 15 is the third harmonic of 5, and 16 the fourth harmonic of 4, so that their intensities will be different, as also will be the intensities of 16 and 18. On the other hand, nearly all the tones which form a *natural* compound tone are present, namely, there are 1, 2, 4, 5, 6, 8, 10, 12, etc., in place of 1, 2, 3, 4, 5, 6, 7, 8, 9, 10, 11, 12, etc. In short, the major triad differs only from a *natural* compound tone in that it consists of a series of simple tones of different intensities, and omits those, which, by beating with its neighbouring tone, would produce dissonance: for example, 7, which would beat with 6 and 8; 9, which would beat with 8 and 10; and 11, which would beat with 10 and 12. It is this circumstance which renders the major chord of such great importance in harmony. If the constituents of the minor chord are similarly discussed, namely, three compound tones whose primaries are proportional to 10, 12, 15, it will be found to differ from the major chord in the following principal respects: (a) The primary of the natural tone to which it approximates is very much deeper than that of the

corresponding major chord. (b) It introduces the *differential* tones, 2, 3, 5, which form a major chord. Now it has already been remarked that when a major and minor chord are sounded together, they are distinctly dissonant; for example, when C, E, G, A are sounded together. Accordingly, the fact of the differential tones forming a major chord shows that an elementary dissonance exists in every minor chord.

## CHAPTER IV.

### VIBRATIONS OF STRETCHED STRINGS, AND OF COLUMNS OF AIR.

258. **Vibrations of strings.**—By a *string* is meant the string of a musical instrument, such as a violin, which is stretched by a certain force, and is commonly of catgut or is a metal wire. The vibrations which strings experience may be either *transversal* or *longitudinal*, but practically the former are alone important. *Transversal vibrations* may be produced by drawing a bow across the string, as in the case of the violin; or by striking the string, as in the case of the pianoforte; or by pulling it transversely, and then letting it go suddenly, as in the case of the guitar and the harp.

259. **Sonometer.**—The *sonometer* is an apparatus by which the transverse vibrations of strings may be studied. It is also called *monochord*, because it has generally only one string. In addition to the string, it consists of a thin wooden box to strengthen the sound; on this there are two fixed bridges, A and D (fig. 203), over which passes the string, which is

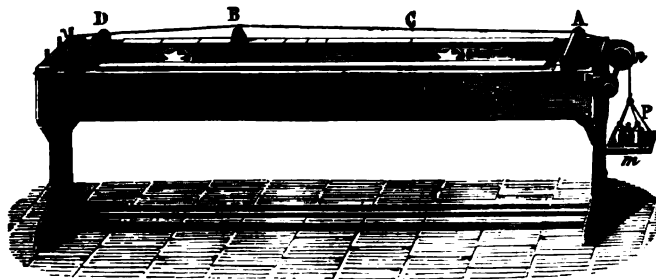

Fig. 203.

usually a metal wire. This is fastened at one end, and stretched at the other by a weight, P, which can be increased at will. By means of a third movable bridge, B, the length of that portion of the wire which is to be put in vibration can be altered at pleasure.

260. **Laws of the transverse vibrations of strings.**—If  $l$  be the length of a string, that is, the vibrating part between two bridges, A and B (fig. 203),  $r$  the radius of the string,  $d$  its density, P the stretching weight, and  $n$  the number of vibrations per second, it is found by calculation that

$n = \frac{1}{2rl} \sqrt{\frac{Pg}{\pi d}}$ ;  $\pi$  being the ratio of the circumference to the diameter,  $g$  the acceleration of gravity.

The above formula expresses the following laws:—

I. *The stretching weight or tension being constant, the number of vibrations in a second is inversely as the length.*

II. *The number of vibrations in a second is inversely as the diameter of the string.*

III. *The number of vibrations in a second is directly as the square root of the stretching weight or tension.*

IV. *The number of vibrations in a second of a string is inversely as the square root of its density.*

These laws are applied in the construction of stringed instruments, in which the length, diameter, tension, and substance of the strings are so chosen, that given notes may be produced from them.

261. **Experimental verification of the laws of the transverse vibration of strings.**—*Law of the lengths.* In order to prove this law, we may call to mind that the relative numbers of vibrations of the notes of the gamut are

C	D	E	F	G	A	B	c
1	$\frac{9}{8}$	$\frac{5}{4}$	$\frac{4}{3}$	$\frac{3}{2}$	$\frac{5}{3}$	$\frac{15}{8}$	2

If now the entire length of the sonometer be made to vibrate, and then, by means of the bridge B, the lengths  $\frac{8}{9}$ ,  $\frac{4}{5}$ ,  $\frac{3}{4}$ ,  $\frac{2}{3}$ ,  $\frac{3}{5}$ ,  $\frac{8}{15}$ ,  $\frac{1}{2}$ , which are the inverse of the above numbers, be successively made to vibrate, all the notes of the gamut are successively obtained, which proves the first law.

*Law of the diameters.* This law is verified by stretching upon the sonometer two cords of the same material, the diameters of which are as 3 to 2, for instance. When these are made to vibrate, the second cord gives the fifth above the other; which shows that it makes three vibrations while the first makes two.

*Law of the tensions.* Having placed on the sonometer two identical strings, they are stretched by weights which are as 4 : 9. The second now gives the fifth of the first, from which it is concluded that the numbers of their vibrations are as 2 : 3, that is, as the square roots of the tensions. If the two weights are as 16 to 25, the major third or  $\frac{5}{4}$  would be obtained.

*Law of the densities.* Two strings of the same radius but different densities are fixed on the sonometer. Having been subjected to the same stretching weight, the position of the movable bridge on the denser one is altered until it is in unison with the other string. If then  $d$  and  $d'$  are the densities of the two strings, and  $l$  and  $l'$  the lengths which vibrate in unison, we find  $\frac{l}{l'} = \frac{\sqrt{d'}}{\sqrt{d}}$ . But as we know from the first law that  $\frac{l}{l'} = \frac{n'}{n}$ , we have

$$\frac{n'}{n} = \frac{\sqrt{d'}}{\sqrt{d}}, \text{ which verifies this law.}$$

262. **Nodes and loops.**—Let us suppose the string AD (fig. 203) to begin vibrating, the ends A and D being fixed, and while it is doing so, let a point, B, be brought to rest by a stop, and let us suppose DB to be one-third part of AD. The part DB must now vibrate about B and D as fixed points in the manner indicated by the continuous and dotted lines; now all parts of

the same string tend to make a vibration in the same time; accordingly the part between A and B will not perform a single vibration, but will divide into two at the point C, and vibrate in the manner shown in the figure. If BD were one-fourth part of AD (fig. 205), the part AD would be subdivided at C and C' into three vibrating portions each equal to BD. The points B, C, C' are called *nodes* or *nodal points*; the middle point of the part of the string between any two consecutive nodes is called a *loop* or a *ventral segment*. It will be remarked that the ratio of BD : BA must be that of some two whole numbers, for example, 1 : 2, 1 : 3, 2 : 3, etc., otherwise the nodes cannot be formed, since the two portions of the string cannot then be made to vibrate in the same time, and the vibrations will interfere with and soon destroy one another.

If now we refer to fig. 204, the existence of the node at C can be easily proved by bending some light pieces of paper, and placing them on the string.

Fig. 204.

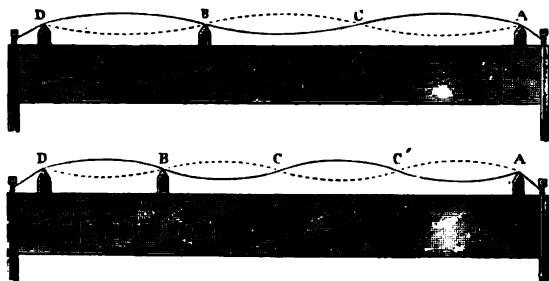

Fig. 205.

Say three pieces, one at C and the others respectively midway between B and C, and between C and A. The one at C experiences only a very slight motion, and remains in its place, thereby proving the existence of a node at C; the other two are violently shaken, and in most cases thrown off the string.

When a musical string vibrates between fixed points A and B, its motion is not quite so simple as might be inferred from the above description. In point of fact, partial vibrations are soon produced, and superimposed upon the primary vibrations. The partial vibrations correspond to the half, third, fourth, etc. parts of the string. It is by these partial vibrations that the harmonics are produced which accompany the primary note due to the primary vibrations.

263. **Wind instruments.**—In the cases hitherto considered the sound results from the vibrations of solid bodies, and the air only serves as a vehicle for transmitting them. In wind instruments on the contrary, when the sides of the tube are of adequate thickness, the enclosed column of air is the sonorous body. In fact, the substance of the tubes is without influence on the primary tone; with equal dimensions it is the same whether the tubes are of glass, of wood, or of metal. These different materials simply do no more than give rise to different harmonics, and thereby impart a different quality to the compound tone produced.

In reference to the manner in which the air in tubes is made to vibrate wind instruments are divided into *mouth* instruments and *reed* instruments.

264. **Mouth instruments.**—In mouth instruments all parts of the mouth-piece are fixed. Fig. 206 represents the mouthpiece of an organ pipe, and fig. 207 that of a whistle, or of a flageolet. In both figures, the aperture *ib* is called the mouth; it is here that air enters the pipe: *b* and *o* are the *lips*, the upper one of which is bevelled. The mouthpiece is fixed at one end of a tube, the other end of which may be either opened or closed. In fig. 207 the tube can be fitted on a wind-chest by means of the foot P.

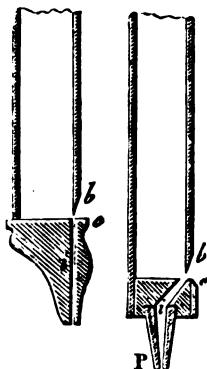

FIG. 206.

FIG. 207.

When a rapid current of air enters by the mouth, it strikes against the upper lip, and a shock is produced which causes the air to issue from *bo* in an intermittent manner. In this way, pulsations are produced which, transmitted to the air in the pipe, make it vibrate, and a sound is the result. In order that a pure note may be produced, there must be a certain relation between the form of the lips and the magnitude of the mouth; the tube also ought to have a great length in comparison with its diameter. The number of vibrations depends in general on the dimensions of the pipe, and the velocity of the current of air.

265. **Reed instruments.**—In reed instruments a simple elastic tongue sets the air in vibration. The tongue, which is either of metal or of wood, is

moved by a current of air. The mouthpieces of the oboe, the bassoon, the clarinet, the child's trumpet, are different applications of the reed, which, it may be remarked, is seen in its simplest form in the Jew's harp. Some organ pipes are reed pipes, others are mouth pipes.

Fig. 208 represents a model of a reed pipe as commonly shown in lectures. It is fixed on the wind-chest Q of a bellows, and the vibrations of the reed can be seen through a piece of glass, E, fitting into the sides. A wooden horn, H, strengthens the sound.

Fig. 209 shows the reed, out of the pipe. It consists of four pieces: 1st, a rectangular wooden tube closed below and open above at *o*; 2nd, a copper plate *cc* forming one side of the tube,



FIG. 208.



FIG. 209.



FIG. 210.

and in which there is a longitudinal aperture, through which air passes from the tube MN to the orifice *o*; 3rd, a thin elastic plate, *i*, called the *tongue*,

which is fixed at its upper end, and which grazes the edge of the longitudinal aperture, nearly closing it; 4th, a curved wire, *r*, which presses against the tongue, and can be moved up and down. It thus regulates the length of the tongue, and determines the pitch of the note. It is by this wire that reed pipes are tuned. The reed being replaced in the pipe MN, when a current of air enters by the foot P, the tongue is compressed, it bends inwards, and affords a passage to air, which escapes by the orifice *o*. But, being elastic, the tongue regains its original position, and performing a series of oscillations successively opens and closes the orifice. In this way sonorous waves result and produce a note, whose pitch increases with the velocity of the current.

In this reed the tongue vibrates alternately before and behind the aperture, and just escapes grazing the edges, as is seen in the harmonium, concertina, etc.; such a reed is called a *free reed*. But there are other reeds called *beating reeds*, in which the tongue, which is larger than the orifice, strikes against the edges at each oscillation. The reed of the clarinet, represented in fig. 210, is an example of this; it is kept in its place by the pressure of the lips. The reeds of the hautboy and bassoon are also of this kind.

266. **Of the tones produced by the same pipe.**—Daniel Bernouilli discovered that the same organ pipe can be made to yield a succession of tones by properly varying the force of the current of air. The results he arrived at may be thus stated:—

i. If the pipe is open at the end opposite to the mouthpiece, then, denoting the primary tone by 1, we can, by gradually increasing the force of the current of air, obtain successively the tones 2, 3, 4, 5, etc., that is to say, the *harmonics* of the primary tone.

ii. If the pipe is closed at the end opposite to the mouthpiece, then, denoting the primary tone by 1, we can, by gradually increasing the force of the current of air, obtain successively the tones 3, 5, 7, etc., that is to say, the uneven *harmonics* of the primary tone.

It must be added that if a closed and an open pipe are to yield the same primary tone, the closed pipe must be half the length of the open pipe, if in other respects they are the same.

In any case it is impossible to produce from the given pipe a tone not included in the above series respectively.

Although the above laws are enunciated with reference to an organ pipe, they are of course true of any other pipe of uniform section.

267. **On the nodes and loops of an organ pipe.**—The vibrations of the air producing a musical tone take place in a direction parallel to the axis of the pipe—not transversely as in the case of the portions of a vibrating spring. In the former case, however, as well as in the latter, the phenomena of *nodes* and *loops* may be produced. But now by a *node* must be understood a section of the column of air contained in the pipe, where the particles remain at rest, but where there are rapid alternations of *condensation* and *rarefaction*. By a *loop* or *ventral segment* must be understood a section of the column of air contained in the pipe where the vibrations of the particles of air have the greatest amplitudes, and where there is no change of density. The sections of the column of air are, of course, made at right angles to its axis. When

the column of air is divided into several vibrating portions, it is found that the distance between any two consecutive loops is constant, and that it is bisected by a node. We can now consider separately the cases of the open and closed pipes.

i. In the case of a stopped pipe, the bottom is always a node, for the layer of air in contact with it is necessarily at rest, and only undergoes variations in density. At the mouthpiece, on the contrary, where the air has a constant density, that of the atmosphere, and the vibration is at its maximum, there is always a loop. In any stopped pipe there is at least one node and one loop (fig. 210); the pipe then yields its fundamental note, and the distance

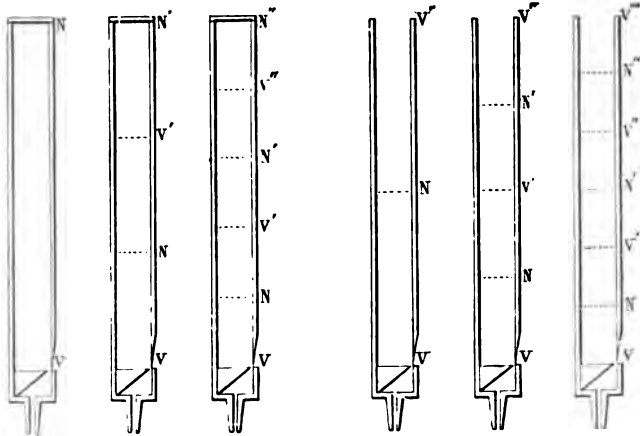

Fig. 211.

Fig. 212.

Fig. 213.

Fig. 214.

Fig. 215.

Fig. 216.

VN from the loop to the node is equal to half a condensed or rarefied wave length.

If the current of air be forced, the mouthpiece always remains a loop, and the bottom a node, the column divides into three equal parts (fig. 212) and an intermediate node and loop are formed. The sound produced is the first harmonic. When the second harmonic (5) is produced, there are two intermediate nodes and two loops, and the tube is then subdivided into five equal parts (fig. 213), and so on.

ii. In the case of the open pipe, whatever tone it produces, there must be a loop at each end, since the enclosed column of air is in contact with the external air at those points. When the primary tone is produced, there will be a loop at each end, and a node at the middle section of the pipe, the nodes and loops dividing the column into *two* equal parts (fig. 214). When the first harmonic (2) is produced, there will be a loop at each end, and a loop in the middle, the column being divided into *four* equal parts by the alternate loops and nodes (fig. 215). When the second harmonic (3) is produced, the column of air will be divided into *six* equal parts by the alternate nodes and loops, and so on (fig. 216). It will be remarked that the successive modes of division of the vibrating column are the only ones compatible with the

alternate recurrence at equal intervals of nodes and loops, and with the occurrence of a loop at each end of the pipe.

There are several experiments by which the existence of nodes and loops can be shown.



Fig. 217.



Fig. 218.



Fig. 219.

(*a*) If a fine membrane is stretched over a pasteboard ring, and has sprinkled on it some fine sand, it can be gradually let down a tube, as shown in fig. 219. Now suppose the tube to be producing a musical note. As the membrane descends, it will be set in vibration by the vibrating air. But when it reaches a node it will cease to vibrate, for there the air is at rest. Consequently the grains of sand, too, will be at rest, and their quiescence will indicate the position of the node. On the other hand, when the membrane reaches a loop, that is, a point where the amplitude of the vibrations of the air attains a maximum, it will be violently agitated, as will be shown by the agitation of the grains of sand. And thus the positions of the loops can be rendered manifest.

(*b*) Again, suppose a pipe to be constructed with holes bored in one of its sides, and these covered by little doors which can be opened and shut, as shown in fig. 217. Let us suppose the little doors to be shut and the pipe to



be caused to produce such a tone that the nodes are at  $N$  and  $N'$  and the loops at  $V, V', V''$ . At the latter points the density is that of the external air, and consequently if the door at  $V'$  is opened no change is produced in the note. At the former points  $N$  and  $N'$  there are alternately condensation and rarefaction taking place. If now the door at  $N'$  is opened, this alternation of density is no longer possible, for the density at this open point must be the same as that of the external air, and consequently  $N'$  becomes a loop, and a note yielded by the tube is changed. The change of notes produced by changing the fingering of the flute is one form of this experiment.

(c) Suppose  $A$ , in fig. 218, to be a pipe emitting a certain note, and suppose  $P$  to be a plug, fitting the tube, fastened to the end of a long rod by which it can be forced down the tube. Now when the plug is inserted, whatever be its position, there will be a node in contact with it. Consequently, as it is gradually forced down, the note yielded by the pipe will keep on changing. But every time it reaches a position which was occupied by a node before its insertion, the note becomes the same as the note originally yielded. For now the column of air vibrates in exactly the same manner as it did before the plug was put in.

(d) Fig. 220 shows another mode of illustrating the same point, which is identical in principle with König's manometric flames. The figure represents an organ pipe, on one side of which is a chest,  $P$ , filled with coal gas, by means of the tube,  $S$ . The gas from the chest comes out in three jets,  $A, B, C$ , and is then ignited. The manner in which the gas passes from the chest to the point of ignition is shown in the smallest figure, which is an enlarged section of  $A$ . A circular hole is bored in the side of the pipe and covered with a membrane,  $r$ . A piece of wood is fitted into the hole so as to leave a small space between it and the membrane. The gas passes from the chest, in the direction indicated by the arrow, into the space between the membrane and the piece of wood, and so out of the tube,  $m$ , at the mouth of which it is ignited. Now suppose the pipe to be caused to yield its primary note, then as it is an uncovered pipe there ought to be a node at  $B$ , its middle point. Consequently there ought to be rapid changes of density at  $B$ ; these would cause the membrane,  $r$ , to vibrate, and thereby blow out flame,  $m$ , and this is what actually happens. If by increasing the force of the wind the octave to the primary note is produced,  $B$  will be a loop, and  $A$  and  $C$  nodes. Consequently the flames at  $A$  and  $C$  will now be extinguished, as is, in point of fact, the case. But at  $B$ , there being no change of density, the membrane is unmoved, and the flame continues to burn steadily.



Fig. 220.

By each and all of these experiments it is shown that in a given pipe,

whether open or closed, there are always a certain number of nodes, and midway between any two consecutive nodes there is always a *loop* or *ventral segment*.

268. **Formulæ relative to the number of vibrations produced by a musical pipe.**—It follows from what has been said that the column of air in stopped pipes is always divided by the nodes and loops into an uneven number of parts which are equal to each other, and each of which is a quarter of a complete vibration (figs. 211, 212, and 213), while in an open pipe it is divided into an even number of such parts (figs. 214, 215, 216). If  $L$  be the length of the pipe,  $l$  the wave length of the sound which it emits, and  $\phi$  any whole number, then for stopped pipes we have  $L = (2\phi + 1) \frac{l}{4}$ ; and for open pipes  $L = 2\phi \frac{l}{4} = \frac{\phi l}{2}$ . Replacing in each of these formulæ  $l$  by its value  $\frac{v}{n}$  (246) we have  $L = (2\phi + 1) \frac{v}{4n}$  and  $L = \frac{\phi v}{2n}$ ; from which for stopped pipes we have  $n = \frac{(2\phi + 1)v}{4L}$ , and for open ones  $n = \frac{\phi v}{2L}$ .

If, in the first formula we give to  $\phi$  the successive values 0, 1, 2, 3, 4, etc., we have  $n = \frac{v}{4L}, \frac{3v}{4L}, \frac{5v}{4L}$ , that is, the fundamental sound and all its uneven harmonics; and in the formula for the open pipe we get similarly  $\frac{v}{2L}, \frac{2v}{2L}, \frac{3v}{2L}$ , etc., that is, the fundamental note and all its harmonics even and uneven.

269. **Explanation of the existence of nodes and loops in a musical pipe.**—The existence of nodes and loops is to be explained by the co-

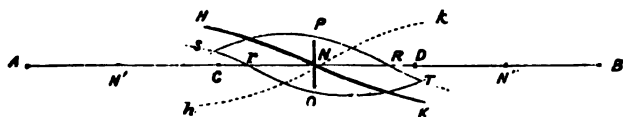

Fig. 221.

existence in the same pipe of two equal waves travelling in contrary directions.

Let A be a point from which a series of waves sets out towards B, and let the length of these waves, whether of condensation or rarefaction, be AC, CD, DB. And let B be the point from which the series of exactly equal waves sets out towards A. It must be borne in mind that in the case of a wave of condensation originating at A the particles move in the direction A to B, but in a wave of condensation originating at B they move in the direction B to A. Now let us suppose that condensation at C, caused by the wave from A, begins at the same instant that condensation caused by the wave from B begins at D. Consequently, restricting our attention to the particles in the line CD, at any instant the velocities of the particles in CD due to the former wave will be represented by the ordinates of the curve SPRT, while those due to the wave from B will be represented by the co-

ordinates of the curve  $TQrS$ . Then, since the waves travel with the same velocity and are at C and D respectively at the same instant, we must have, for any subsequent instant,  $CR$  equal to  $Dr$ . If, therefore, N is the middle point between C and D, we must have  $rN$  equal to  $RN$ , and consequently  $PN$  equal to  $QN$ , that is to say, if the particle at N transmitted only one vibration, its motion at each instant would be in the opposite phase to that of its motion if it transmitted only the other vibration. In other words, the particle N will at every instant tend to be moved with equal velocity in opposite directions by the two waves, and therefore will be *permanently* at rest. That point is therefore a *node*. In like manner there is a node at  $N'$  midway between A and C, and also at  $N''$  midway between B and D. In regard to the motion of the remaining particles, it is plain that their respective velocities will be the (algebraical) sum of the velocities they would at each instant receive from the waves separately. Hence at the instant indicated by the diagram they are given by the ordinates of the curve  $HNK$ . This curve will change from instant to instant, and at the end of the time occupied by the passage of a wave of condensation (or of rarefaction) from C to D will occupy the position shown by the dotted line  $hNk$ . Hence it is evident that particles near N have but small changes of velocity, whilst those near C and D experience large changes of velocity.

If the curve  $HK$  were produced both ways, it would always pass through  $N'$  and  $N''$ ; the part, however, between N and  $N'$  would sometimes be on one side and sometimes on the other side of AB. Hence all the particles between  $N'$  and N have, simultaneously, first a motion in the direction A to B, and then a motion in the direction B to A, those particles near C having the greatest amplitude of vibrations. Hence near N and  $N'$  there will be alternately the greatest condensation and rarefaction.

This explanation applies to the case in which AB is the axis of an open organ pipe, A being the end where the mouthpiece is situated. The waves from B have their origin in the reflections of the series of waves from A. In the particular case considered, the note yielded by the pipe is that indicated by 3, that is, the fifth above the octave to the primary note. A similar explanation can obviously be applied to all other cases, and whether the end be opened or closed. But in the latter case the series of waves from the closed end must commence at a point distant from the mouthpiece by a space equal to one half, or three halves, or five halves, etc., of the length of a wave of condensation or expansion.

**270. Kundt's determination of the velocity of sound.**—Kundt has devised a method of determining the velocity of sound in solids and in gases which can be easily performed by means of simple apparatus, and is capable of great accuracy. A glass tube, BB, about two yards long (fig. 222), and two inches in the clear, is closed at one end by a movable stopper  $b$ ; the other end is fitted with a cork KK, which tightly grasps a glass tube, AA, of smaller dimensions. This is closed at one end by a piston,  $a$ , which moves with gentle friction in the outer tube BB. Then by rubbing the free end of the tube, AA, with a wet cloth, it produces longitudinal vibrations, and these transmit their motion to the air in the part  $ab$ . If the tube  $ab$  contain some lycopodium powder, this is set in active vibration and then arranges itself in small patches in a certain definite order as represented in the figure;

the nature and arrangement of which depend on the vibrating part of the rod and the tube.

These heaps represent the nodes, and the mean distance  $d$  between them can be measured with great accuracy; it represents the distance between two nodes, or, half a wave length; that is the wave length of the sound in air is  $2d$ . If the rod has the length  $s$  and is grasped in the middle by the cork  $KK$ , from the law of the longitudinal vibrations of rods, (274) the wave length of the sound it then emits is twice its length or  $2s$ . That is the wave length of the vibrating column of air is to that in the rod as  $2d : 2s$ . As the velocity of sound in any body is equal to the wave length in that body multiplied by the number of vibrations in a second; and since the number of vibrations is here the same in both cases, for the tone is the same, the velocity of sound in the glass is to the velocity of sound in air as  $2sn : 2dn$ , that is as  $s : d$ . Thus when the glass tube was clamped in the middle by  $KK$ , so that the length  $ab$  was equal to half the length of the tube  $A'A$ , the number of the ventral segments was eight. This corresponds to a ratio of wave length of 1 to 16: in other words the velocity of sound in glass is 16 times that in air.

The method is capable of great extension. By means of the stopcock  $m$ , different gases could be introduced instead of air, and corresponding differences found for the length of the ventral segments; from which, by a simple calculation, the corresponding velocities were found. Thus the velocities of sound in carbonic acid, coal gas, and hydrogen, were found to be respectively 0.8, 1.6, and 3.56 that of air, or, nearly as the inverse square of the densities.

So also by varying the material of the rod  $Aa$ , different velocities are obtained. Thus the velocity in steel was found to be 15.24, and that in brass 10.87 that of air.

*Kundt's figures* may also be obtained by providing glass tubes, a yard or two in length with lycopodium powder, as in the above experiment, and hermetically sealing them at both ends. The tubes are then put into longitudinal vibrations; instead of air they may be filled with hydrogen or any other gas.

271. **Chemical harmonicon.**—The air in an open tube may be made to give a sound by means of a luminous jet of hydrogen, coal gas, etc. When a glass tube about 12 inches long is held over a lighted jet of hydrogen (fig. 223), a note is produced, which, if the tube is in a certain position, is the fundamental note of the tube. The sounds, doubtless, arise from the successive explosions produced by the periodic combinations of the atmospheric oxygen with the issuing jet of hydrogen. The apparatus is called the *chemical harmonicon*.

The note depends on the size of the flame and the length of the tube: with a long tube, by varying the position of the jet in the tube, the series of notes in the ratio 1 : 2 : 3 : 4 : 5 is obtained.



Fig. 222.

If, while the tube emits a certain sound, the voice or the syren (237) be gradually raised to the same height, as soon as the note is nearly in unison with the harmonicon, the flame becomes agitated, jumps up and down, and is finally steady when the two sounds are in unison. If the note of the syren is gradually heightened the pulsations again commence; they are the optical expressions of the beats (255) which occur near perfect unison.

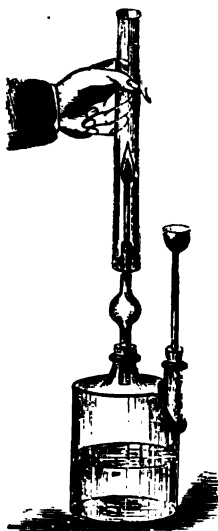

Fig. 223.

If, while the jet burns in the tube and produces a note, the position of the tube is slightly altered, a point is reached at which no sound is heard. If now the voice, or the syren, or the tuning-fork, be pitched at the note produced by the jet, it begins to sing, and continues to sing even after the syren is silent. A mere noise, or shouting at an incorrect pitch, affects the flame, but does not cause it to sing.

272. **Stringed instruments.**—Stringed musical instruments depend on the production of transverse vibrations. In some, such as the piano, the sounds are *constant*, and each note requires a separate string; in others, such as the violin and guitar, the sounds are *varied* by the fingering, and can be produced by fewer strings.

In the piano the vibrations of the strings are produced by the stroke of the *hammer*, which is moved by a series of bent levers communicating with the keys. The sound is strengthened by the vibrations of the air in the sounding board on which the strings are stretched. Whenever a key is struck, a *dampener* is raised which falls when the finger is removed from the key, and stops the vibrations of the corresponding string. By means of a *pedal* all the dampeners can be simultaneously raised, and the vibrations then last for some time.

The harp is a sort of transition from the instruments with constant to those with variable sounds. Its strings correspond to the natural notes of the scale: by means of the pedals the lengths of the vibrating parts can be changed, so as to produce sharps and flats. The sound is strengthened by the sounding-box, and by the vibrations of all the strings harmonic with those played.

In the violin and guitar each string can give a great number of sounds according to the length of the vibrating part, which is determined by the pressure of the fingers of the left hand while the right hand plays the bow, or the strings themselves. In both these instruments the vibrations are communicated to the upper face of the sounding box, by means of the bridge over which the strings pass. These vibrations are communicated from the upper to the lower face of the box, either by the sides or by an intermediate piece called the *sound post*. The air in the interior is set in vibration by both faces, and the strengthening of the sound is produced by all these simultaneous vibrations. The value of the instrument consists in the per-

fection with which all possible sounds are intensified, which depends essentially on the quality of the wood, and the relative arrangement of the parts.

273. **Wind instruments.**—All wind instruments may be referred to the different types of sounding tubes which have been described. In some, such as the organ, the notes are *fixed*, and require a separate pipe for each note, in others the notes are *variable*, and are produced by only one tube: the flute, horn, etc. are of this class.

In the organ the pipes are of various kinds, namely, mouth pipes, open and stopped, and reed pipes with apertures of various shapes. By means of *stops* the organist can produce any note by both kinds of pipe.

In the *flute*, the mouthpiece consists of a simple lateral circular aperture; the current of air is directed by means of the lips, so that it grazes the edge of the aperture. The holes at different distances are closed either by the fingers or by keys; when one of the holes is opened, a loop is produced in the corresponding layer of air, which modifies the distribution of nodes and loops in the interior, and thus alters the note. The whistling of a key is similarly produced.

The *pandæan pipe* consists of tubes of different sizes corresponding to the different notes of the gamut.

In the trumpet, the horn, the trombone, cornet-à-piston, and ophicleide, the lips form the reed, and vibrate in the mouthpiece. In the *horn*, different notes are produced by altering the distance of the lips. In the *trombone*, one part of the tube slides within the other, and the performer can alter at will the length of the tube, and thus produce higher or lower notes. In the *cornet-à-piston* the tube forms several convolutions; pistons placed at different distances can, when played, cut off communication with other parts of the tube, and thus alter the length of the vibrating column of air.

## CHAPTER V.

### VIBRATIONS OF RODS, PLATES, AND MEMBRANES.

274. **Vibrations of rods.**—Rods and narrow plates of wood, of glass, and especially of tempered steel, vibrate in virtue of their elasticity; like strings they have two kinds of vibrations, *longitudinal* and *transverse*. The latter are produced by fixing the rods at one end, and passing a bow over the free part. Longitudinal vibrations are produced by fixing the rod at any part, and rubbing it in the direction of its length with a piece of cloth sprinkled with resin. But in the latter case the sound is only produced when the point of the rod at which it has been fixed is some aliquot part of its length, as a half, a third, or a quarter.

It is shown by calculation that *the number of transverse vibrations made in a given time by rods and thin plates of the same kind is directly as their thickness, and inversely as the square of their length.* The width of the plate does not affect the number of vibrations. A wide plate, however, requires a greater force to set it in motion than a narrow one. It is, of course, understood that one end of the vibrating plate is held firmly.

The laws of the longitudinal vibrations of strings, are expressed in the formula  $n = \frac{1}{2rl} \sqrt{\frac{g\mu}{\pi d}}$ , in which  $n$ ,  $r$ ,  $l$ ,  $d$ , and  $g$  have all the same meaning as in the formula for the transverse vibrations, while  $\mu$  is the coefficient of elasticity of the string, the number which expresses the weight by which the cord must be stretched in order to elongate by its own length (89).



Fig. 224.

Fig. 224 represents an instrument invented by Marloye, and known as *Marloye's harp*, based on the longitudinal vibration of rods. It consists of a solid wooden pedestal in which are fixed twenty thin deal rods, some coloured and others white. They are of such a length that the white rods give the diatonic scale, while the coloured ones give the semitones, and complete the chromatic scale. The instrument is played by rubbing the rods in the direction of their length between the finger and thumb, which have been previously covered with powdered resin. The notes produced resemble those of a pandæan pipe.

The *tuning-fork*, the *triangle*, and *musical boxes* are examples of the transverse vibrations of rods. In musical boxes small plates of steel of different dimensions are fixed on a rod, like the teeth of a comb. A cylinder whose axis is parallel to this rod, and whose surface is studded with steel teeth, arranged in a certain order, is placed near the plates. By means of a clockwork motion, the cylinder rotates, and the teeth striking the steel plate set them in vibration, producing a tune, which depends on the arrangement of the teeth on the cylinder.

If a given rod be clamped either in the middle, or at both ends, the wave length of the note produced by making it vibrate longitudinally, is double its own length, and if it be clamped at one end only, and made to vibrate longitudinally, the wave length of the sound is four times its own length.

Thus the former case is analogous to an open pipe, and the latter to a stopped pipe in respect of the sounds produced.

275. **Vibrations of plates.**—In order to make a plate vibrate, it is fixed in the centre (fig. 225), and a bow rapidly drawn across one of the edges; or else it is fixed at any point of its surface, and caused to vibrate by rapidly drawing a string covered with resin against the edges of a central hole (fig. 226).

Vibrating plates contain nodal lines (262), which vary in number and

position according to the form of the plates; their elasticity, the mode of excitation, and the number of vibrations. These nodal lines may be made visible by covering the plate with fine sand before it is made to vibrate. As soon as the vibrations commence, the sand leaves the vibrating parts, and accumulates on the nodal lines, as seen in figs. 225 and 226.

The position of the nodal lines may be determined by touching the points at which it is desired to produce them. Their number increases with the number of vibrations, that is, as the note given by the plates is higher. The nodal lines always possess great symmetry of form, and the same form



Fig. 225.

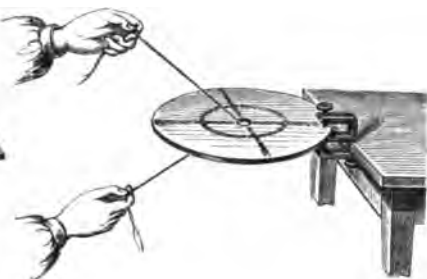

Fig. 226.

is always produced on the same plate under the same conditions. They were discovered by Chladni.

The vibrations of plates are governed by the following law:—*In plates of the same kind and shape, and giving the same system of nodal lines, the number of vibrations per second is directly as the thickness of the plates, and inversely as their area.*

*Gongs* and *cymbals* are examples of instruments in which sounds are produced by the vibration of metal plates. The *glass harmonicon* depends on the vibrations of glass plates.

276. **Vibrations of membranes.**—In consequence of their flexibility membranes cannot vibrate unless they are stretched, like the skin of a drum. The sound they give is more acute in proportion as they are smaller and more tightly stretched. To obtain vibrating membranes, Savart fastened gold-beater's skin on wooden frames.

In the *drum*, the skins are stretched on the ends of a cylindrical box. When one end is struck, it communicates its vibrations to the internal column of air, and the sound is thus considerably strengthened. The cords stretched against the lower skin strike against it when it vibrates, and produce the sound characteristic of the drum.

Membranes either vibrate by direct percussion, as in the drum, or they may be set in vibration by the vibrations of the air, as Savart has observed, provided these vibrations are sufficiently intense. Fig. 227 shows a mem-



brane vibrating under the influence of the vibrations in the air caused by a sounding bell. Fine sand strewn on the membrane shows the formation of nodal lines just as upon plates.

There are numerous instances in which solid bodies are set in vibration by the vibrations of the air. The condition most favourable for the produc-

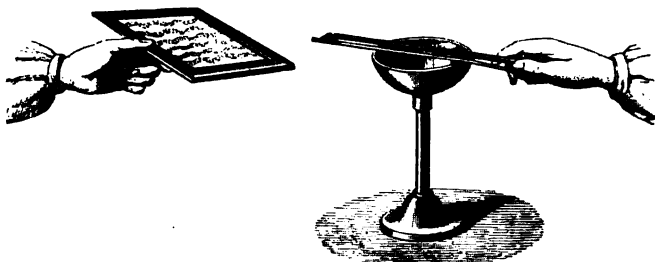

Fig. 227.

tion of this phenomenon is, that the body to be set in vibration is under such conditions that it can readily produce vibrations of the same duration as those transmitted to it by the air. The following are some of these phenomena :

If two violoncello strings tuned in unison are stretched on the same sound-box, as soon as one of them is sounded, the other is set in vibration. This is also the case if the interval of the strings is an octave, or a perfect fifth. A violin string may also be made to vibrate by sounding a tuning-fork.

Two large glasses are taken of the same shape, and as nearly as possible of the same dimensions and weight, and are brought in unison by pouring into them proper quantities of water. If now one of them is sounded, the other begins to vibrate, even if it is at some distance, but if water be added to the latter, it ceases to vibrate.

Breguet found that if two clocks, whose time was not very different, were fixed on the same metallic support, they soon attained exactly the same time.

Membranes are eminently fitted for taking up the vibrations of the air, on account of their small mass, their large surface, and the readiness with which they subdivide. With a pretty strong whistle, nodal lines may be produced in a membrane stretched on a frame, even at the distant end of a large room.

The phenomenon so easily produced in easily-moved bodies is also found in large and less elastic masses ; all the pillars and walls of a church vibrate more or less while the bells are being rung.

## CHAPTER VI.

## GRAPHICAL METHOD OF STUDYING VIBRATORY MOTIONS.

277. **M. Lissajous' method of making vibrations apparent.**—The method of M. Lissajous exhibits the vibratory motion of bodies either directly or by projection on a screen. It has also the great advantage that the vibratory motions of two sounding bodies may be compared *without the aid of the ear*, so as to obtain the exact relation between them.

This method, which depends on the persistence of visual sensations on the retina, consists in fixing a small mirror on the vibrating body, so as to vibrate with it, and impart to a luminous ray a vibratory motion similar to its own.

M. Lissajous uses tuning-forks, and fixes to one of the prongs a small metallic mirror, *m* (fig. 228), and to the other a counterpoise, *n*, which is

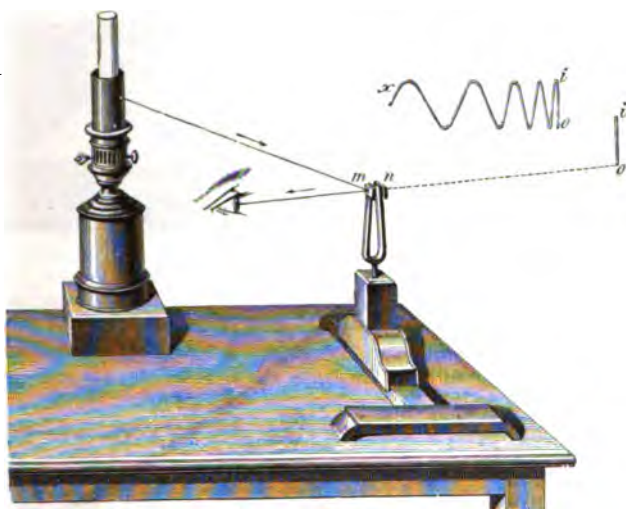

Fig. 228.

necessary to make the tuning-fork vibrate regularly for a long time. At a few yards' distance from the mirror there is a lamp surrounded by a dark chimney, in which is a small hole, giving a single luminous point. The tuning-fork being at rest, the eye is placed so that the luminous point is seen at *o*. The tuning-fork is then made to vibrate, and the image elongates so as to form a persistent image, *oi*, which diminishes in proportion as the amplitude of the oscillation decreases. If, during the oscillation of the mirror, it is made to rotate by rotating the tuning-fork on its axis, a sinuous line, *oix*, is produced instead of the straight line *oi*. These different effects are explained by the successive displacements of the luminous pencil, and by the

duration of these luminous impressions on the eye after the cause has ceased, a phenomenon to which we shall revert in treating of vision.

If instead of viewing these effects directly, they are projected on the screen, the experiment is arranged as shown in fig. 229, the pencil reflected

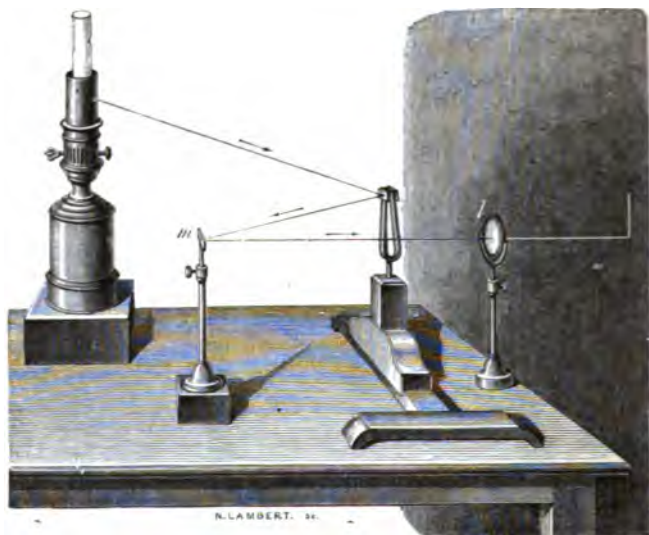

Fig. 229.

from the vibrating mirror is reflected a second time from a fixed mirror, *M*, which sends it towards an achromatic lens, *L*, placed so as to project the images on the screen.

278. **Combination of two vibratory motions in the same direction.**—M. Lissajous has resolved the problem of the optical combination of two vibratory motions—vibrating at first in the same direction, and then at right angles to each other.

Fig. 230 represents the experiment as arranged for combining two parallel motions. Two tuning-forks provided with mirrors are so arranged that the light reflected from one of them reaches the other, which is almost parallel to it, and is then sent towards a screen after having passed through a lens.

If now the first tuning-fork alone vibrates, the image on the screen is the same as in figure 230; but if they both vibrate, supposing they are in unison, the elongation increases or diminishes according as the simultaneous motions imparted to the image by the vibrations of the mirrors do or do not coincide.

If the tuning-forks pass their position of equilibrium in the same time, and in the same direction, the image attains its maximum; and the image is at its minimum when they pass at the same time but in opposite directions. Between these two extreme cases the amplitude of the image varies

according to the time which elapses between the exact instant at which the tuning-forks pass through their position of rest respectively. The ratio of this time to the time of a double vibration is called a *difference of phase* of the vibration.

If the tuning-forks are exactly in unison, the luminous appearance on the screen experiences a gradual diminution of length in proportion as the ampli-

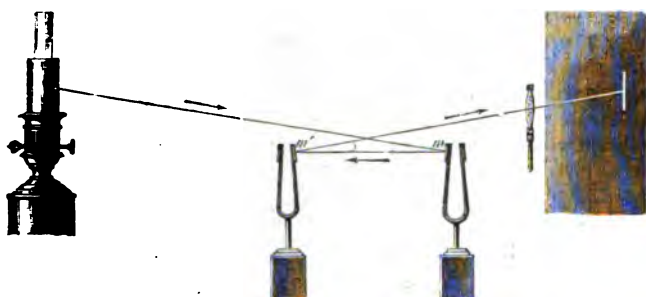

Fig. 230.

tude of the vibration diminishes ; but if the pitch of one is very little altered, the magnitude of the image varies periodically, and, while the beats resulting from the imperfect harmony are distinctly heard, the eyes see the concomitant pulsations of the image.

**279. Optical combination of two vibratory motions at right angles to each other.**—The optical combination of two rectangular vibratory motions is effected as shown in the figure 231, that is, by means of two



Fig. 231.

tuning-forks, one of which is horizontal and the other vertical, and both provided with mirrors. If the horizontal fork first vibrates alone, a horizontal luminous outline is seen on the screen, while the vibration of the other produces a vertical image. If both tuning-forks vibrate simultaneously the two motions combine, and the reflected pencil describes a more

or less complex curve, the form of which depends on the number of vibrations of the two tuning-forks in a given time. This curve gives a valuable means of comparing the number of vibrations of two sounding bodies.

Fig. 232 shows the luminous image on the screen when the tuning-forks are in unison, that is, when the number of vibrations is equal.

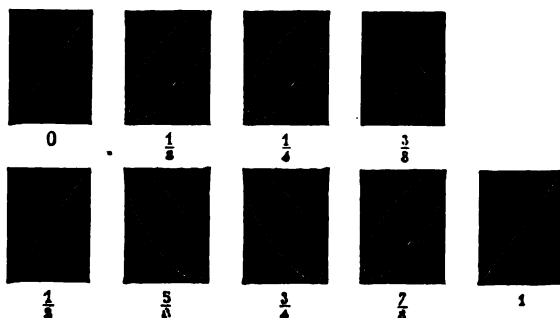

Fig. 232.

The fractions below each curve indicate the differences of phase between them. The initial form of the curve is determined by the difference of phase. The curve retains exactly the same form when the tuning-forks are in unison, provided that the amplitudes of the two rectangular vibrations decrease in the same ratio.

If the tuning-forks are not quite in unison, the initial difference of phase is not preserved, and the curve passes through all its variations.

Fig. 233 represents the different appearances of the luminous image when

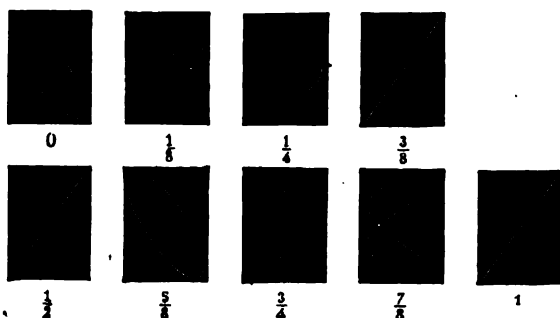

Fig. 233.

the difference between the tuning-forks is an octave; that is, when the numbers of their vibrations are as 1 : 2; and fig. 234 gives the series of curves when the numbers of the vibrations are as 3 : 4.

It will be seen that the curves are more complex when the ratios or the numbers of vibrations are less simple. M. Lissajous has examined these curves theoretically and has calculated their general equations.

When these experiments are made with a Duboscq's photo-electrical apparatus instead of an ordinary lamp, the phenomena are remarkably brilliant.

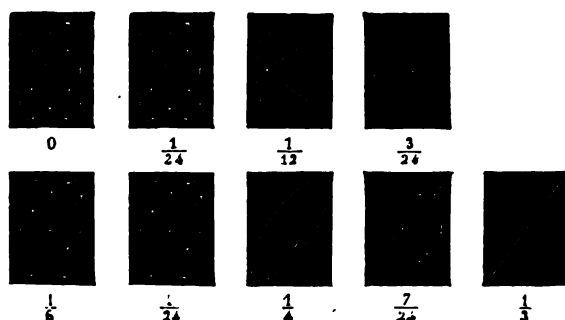

Fig. 234.

280. **Léon Scott's Phonautograph.**—This beautiful apparatus possesses the great advantage of being able to register not only the vibrations produced by solid bodies, but also those produced by wind instruments, by the voice in singing, and even by any noise whatsoever, for instance, that of

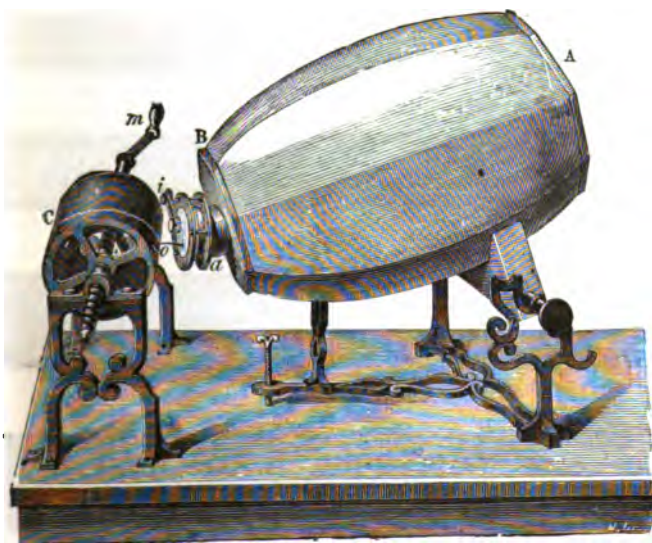

Fig. 235.

thunder, or the report of a cannon. It consists of an ellipsoidal barrel, A B, about a foot and a half long and a foot in its greatest diameter, made of plaster of Paris. The end A is open, but the end B is closed by a solid bottom, to the middle of which is fitted a brass tube, *a*, bent at an elbow

and terminated by a ring on which is fixed a flexible membrane which by means of a second ring can be stretched to the required amount. Near the centre of the membrane, fixed by sealing-wax, is a hog's bristle which acts as a style, and, of course, shares the movements of the membrane. In order that the style might not be at a *node*, M. Scott fitted the stretching ring with a movable piece, *s*, which he calls a subdivider, and which, being made to touch the membrane first at one point and then at another, enables the experimenter to alter the arrangements of the nodal lines at will. By means of a subdivider the point is made to coincide with a loop, that is, a point where the vibrations of the membrane are at a maximum.

When a sound is produced near the apparatus, the air in the ellipsoid, the membrane, and the style will vibrate in unison with it, and it only remains to trace on a sensitive surface the vibrations of the style, and to fix them. For this purpose there is placed in front of the membrane a brass cylinder, *C*, turning round a horizontal axis by means of a handle, *m*. On the prolonged axis of the cylinder a screw cut which works in a nut; consequently, when the handle is turned, the cylinder gradually advances in the direction of its axis. Round the cylinder is wrapped a sheet of paper, covered with a thin layer of lampblack.

The apparatus is used by bringing the prepared paper into contact with the point of the style, and then setting the cylinder in motion round its



Fig. 236.



Fig. 237.



Fig. 238.



Fig. 239.

axis. So long as no sound is heard the style remains at rest, and merely removes the lampblack along a line which is a helix on the cylinder, but which becomes straight when the paper is unwrapped. But when a sound is heard, the membrane and the style vibrate in unison, and the line traced

out is no longer straight, but undulates ; each undulation corresponding to a double vibration of the style. Consequently the figures thus obtained faithfully denote the number, amplitude, and isochronism of the vibrations.

Fig. 236 shows the trace produced when a simple note is sung, and strengthened by means of its upper octave. The latter note is represented by the curve of lesser amplitude. Fig. 237 represents the sound produced jointly by two pipes whose notes differ by an octave. Fig. 238 in its lower line represents the rolling sound of the letter R when pronounced with a ring ; and fig. 239 on its lower line represents the sound produced by a tin plate when struck with the finger.

The upper lines of figs. 238 and 239 are the same, and represent the perfectly isochronous vibrations of a tuning-fork placed near the ellipsoid. These lines were traced by a fine point on one branch of the fork, which was thus found to make exactly 500 vibrations per second. In consequence, each undulation of the upper line corresponds to the  $\frac{1}{500}$ th part of a second ; and thus these lines become very exact means of measuring short intervals of time. For example, in fig. 238, each of the separate shocks producing the rolling sound of the letter R corresponds to about 18 double vibrations of the tuning-fork, and consequently lasts about  $\frac{18}{500}$  or about  $\frac{1}{28}$ th of a second.

281. **König's manometric flames.**—König's method consists in transmitting the movement of the sonorous waves which constitute a sound to

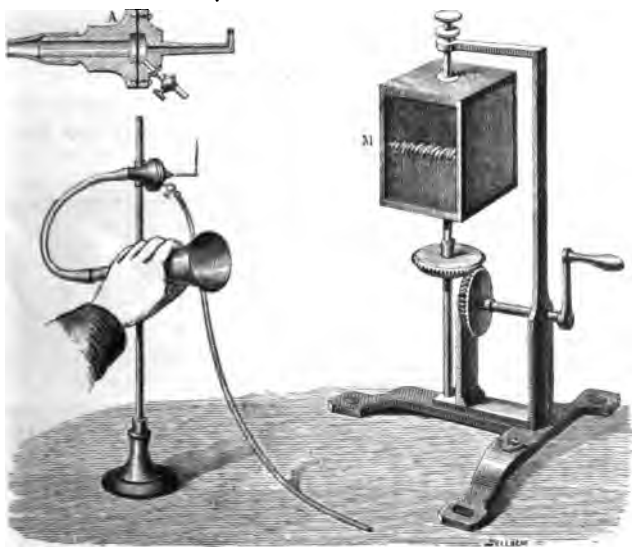

Fig. 240.

gas flames, which, by their pulsations, indicate the nature of the sounds. For this purpose a metal capsule, represented in section at A, fig. 240, is divided into two compartments by a thin membrane of caoutchouc ; on the



right of the figure is a gas jet, and below it a tube conveying coal gas ; on the left is a tubulure, to which may be attached a caoutchouc tube. The other end of this may be placed at the node of an organ-pipe (267) or it terminates in a mouth-piece, in front of which a given note may be sung ; this is the arrangement represented in fig. 240.

When the sound waves enter the capsule by the mouth-piece and the tube, the membrane yielding to the condensation and rarefaction of the

Fig. 241.



Fig. 242.

waves, the coal gas in the compartment on the right is alternately contracted and expanded, and hence are produced alternations in the length of the

Fig. 243.

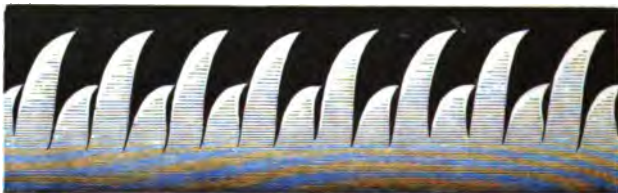

Fig. 244.

flame, which are, however, scarcely perceptible when the flame is observed directly. But to render them distinct they are received on a mirror with

four faces, M, which may be turned by two cog-wheels and a handle. As long as the flame burns steadily there appears in the mirror, when turned, a continuous band of light. But if the capsule is connected with a sounding tube yielding the fundamental note, the image of the flame takes the form represented in fig. 241, and that of the figure 242 if the sound yields the octave. If the two sounds reach the capsule simultaneously the flame has

Fig. 245.

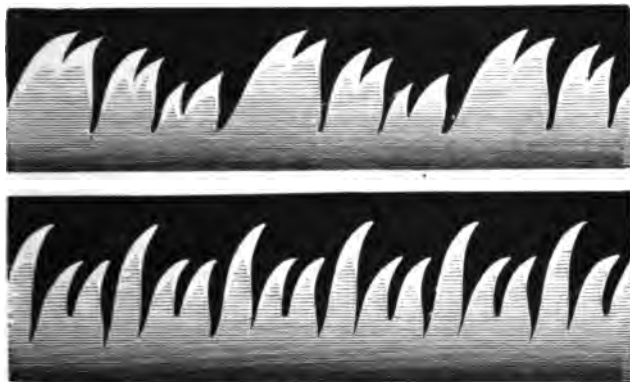

Fig. 246.

the appearance of fig. 243; in that case, however, the tube leading to the capsule must be connected by a T-pipe with two sounding tubes, one giving the fundamental note, and the other the octave. If one gives the funda-

Fig. 247

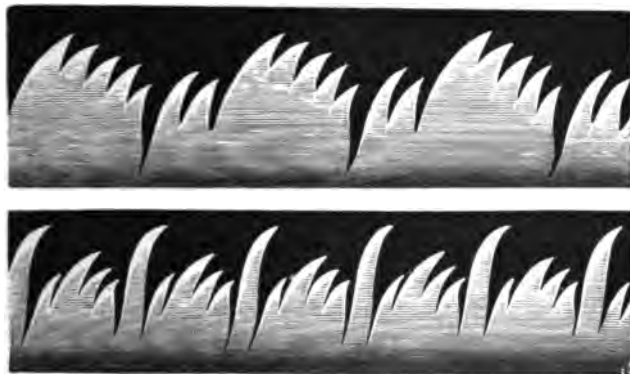

Fig. 248.

mental note and the other the third, the flame has the appearance of figure 244.

If the vowel E be sung in front of the mouth-piece first upon  $c$ , and then

upon  $c'$ , the turning mirror gives the flames represented in figs. 245 and 246; and by singing the vowel O on the same notes the figs. 247 and 248.

**282. Determination of the intensity of sounds.**—Meyer has devised a plan by which the intensities of two sounds of the same pitch may be directly compared. The two sounds are separated from each other by a medium impervious to sound, and in front of each of them is a resonance globe (250) accurately tuned to the sound. Each of these resonance globes is attached by means of caoutchouc tubes of equal length to the two ends of a U tube, in the middle of the bend of which is a third tube provided with a manometric capsule.

If the resonance globes are each at the same distance from the sounding bodies, and, if the note of only one of them is produced the flame vibrates. If both sounds are produced, and they are of the same intensity, and in the same phase, they interfere completely in the tube, so that the flame of the manometric capsule is quite stationary, and appears in the turning mirror as a straight luminous band.

If, however, the sounds are not of the same intensity the interference will be incomplete, and the luminous band will be jagged at the edge. The distance of one of the sounds from the resonance globes is altered until the flame is stationary. The intensities of the two sounds are thus directly as the squares of their distances from the resonators.

**283. Acoustic Attraction and Repulsion.**—It has been observed by Guyot, and afterwards independently by Guthrie and by Schellbach, that a sounding body, one in a state of vibration therefore, exercises an action on a body in its neighbourhood which is sometimes one of attraction and sometimes of repulsion. The vibrations of an elastic medium attract bodies which are specifically heavier than itself, and repel those which are specifically lighter. Thus a balloon of goldbeater's skin filled with carbonic acid, is attracted towards the opening of a resonance box on which is a vibrating tuning-fork; while a similar balloon filled with hydrogen and tied down by a thread is repelled. This result always follows, even when the hydrogen balloon is made heavier than air by loading it with wax.

A light piece of cardboard suspended and held near a tuning-fork moves towards it when the fork is made to vibrate. If the tuning-fork is suspended and is then made to vibrate, it moves towards the card if the latter is fixed. Two suspended tuning-forks in a state of vibration move towards each other. The flame of a candle placed near the end of a sounding tuning-fork was repelled if held near it; if held underneath it was flattened out to a disc. A gas flame near the end of the tuning-fork was divided into two arms.

These phenomena do not seem to be due to the aspirating action of currents of air, nor are they caused by any heating effect; and it must be confessed that the phenomena require further elucidation.

Guthrie finds that when one prong of a tuning-fork is enclosed in a tube provided with a capillary tube dipping into a liquid and is set in vibration by bowing the free prong, the air around the enclosed prong is expanded, and he thence concludes that the approach, above described, of a suspended body to the sounding fork, is due to the diminution of the pressure of the air between the fork and the body below that on the other side of the body.

## BOOK VI.

## ON HEAT.

## CHAPTER I.

## PRELIMINARY IDEAS. THERMOMETERS.

284. **Heat. Hypothesis as to its nature.**—In ordinary language the term *heat* is used not only to express a particular sensation, but also to describe that particular state or condition of matter which produces this sensation. Besides producing this sensation, heat acts variously upon bodies ; it melts ice, boils water, makes metals red-hot, produces electrical currents, decomposes compound bodies, and so forth.

Two theories as to the cause of heat have been propounded ; these are the *theory of emission* and the *theory of undulation*.

On the first theory, heat is caused by a subtle imponderable fluid, which surrounds the molecules of bodies, and which can pass from one body to another. These *heat atmospheres*, which thus surround the molecules, exert a repelling influence on each other, in consequence of which heat acts in opposition to the force of cohesion. The entrance of this substance into our bodies produces the sensation of warmth, its egress the sensation of cold.

On the second hypothesis the heat of a body is caused by an extremely rapid oscillating or vibratory motion of its molecules ; and the hottest bodies are those in which the vibrations have the greatest velocity and the greatest amplitude. At any given time the whole of the molecules of a body possess a sum of *vis viva* which is the heat they contain. To increase their temperature is to increase their *vis viva* ; to lower their temperature is to decrease their *vis viva*. Hence, on this view, heat is not a substance but a *condition of matter*, and a condition which can be transferred from one body to another. When a heated body is placed in contact with a cooler one the former cedes more molecular motion than it receives ; but the loss of the former is the equivalent of the gain of the latter.

It is also assumed that there is an imponderable elastic ether, which pervades all matter and infinite space. A hot body sets this in rapid vibration, and the vibrations of this ether being communicated to material objects set them in more rapid vibration, that is, increase their temperature. Here we have an analogy with sound ; a sounding body is in a state of vibration, and

its vibrations are transmitted by atmospheric air to the auditory apparatus in which is produced the sensation of sound.

This hypothesis as to the nature of heat is now admitted by the most distinguished physicists. It affords a better explanation of all the phenomena of heat than any other theory; and it reveals an intimate connection between heat and light. It will be subsequently seen that by the friction of bodies against each other an indefinite quantity of heat is produced. Experiment has shown that there is an exact equivalence between the motion thus destroyed and the heat produced. These and many other facts are utterly inexplicable on the assumption that heat is a substance, and not a form of motion.

In what follows, however, the phenomena of heat will be considered, as far as possible, independently of either hypothesis; but we shall subsequently return to the reasons for the adoption of the latter hypothesis.

Assuming that the heat of bodies is due to the motion of their particles, we may admit the following explanation as to the nature of this motion in the various forms of matter.

In *solids* the molecules have a kind of vibratory motion about certain fixed positions. This motion is probably very complex; the constituents of the molecule may oscillate about each other, besides the oscillation of the molecule as a whole, and this latter again may be a to-and-fro motion, or it may be a rotatory motion about the centre.

In the *liquid* state the molecules have no fixed positions. They can rotate about their centres of gravity, and the centre of gravity itself may move. But the repellent action of the motion, compared with the mutual attraction of the molecules is not sufficient to separate the molecules from each other. A molecule no longer adheres to particular adjacent ones; but it does not spontaneously leave them except to come into the same relation to fresh ones as to its previous adjacent ones. Thus in a liquid there is a vibratory, rotatory, and progressive motion.

In the *gaseous* state the molecules are entirely without the sphere of their mutual attraction. They fly forward in straight lines according to the ordinary laws of motion, until they impinge against other molecules, or against a fixed envelope which they cannot penetrate, and then return in an opposite direction, with, in the main, their original velocity. The perfection of the gaseous state implies that the space actually occupied by the molecules of the gas be infinitely small compared with the entire volume of the gas; that the time occupied by the impact of a molecule either against another molecule or against the sides of the vessel be infinitely small in comparison with the interval between any two impacts; and that the influence of molecular attraction be infinitely small. When these conditions are not fulfilled the gas partakes more or less of the nature of a liquid, and exhibits certain deviations from Boyle's law. This is the case with all gases; to a very slight extent with uncondensable gases, but to a far greater extent with vapours and condensable gases, especially near their points of liquefaction.

**285. General effects of heat.**—The general effects of heat upon bodies may be classed under three heads. One portion is expended in raising the temperature of the body, that is, in increasing the *vis viva* of its molecules. In the second place, the molecules of bodies have a certain attraction for each other, owing to which is due their relative positions; hence a second

portion of heat is consumed in augmenting the amplitude of the oscillations, by which an increase of volume is produced, or in completely altering the relative positions of the molecules by which a change of state is effected. These two effects are classed as *internal work*. Thirdly, since bodies are surrounded by atmospheric air which exerts a certain pressure on their surface, this has to be overcome or lifted through a certain distance. The heat or work required for this is called the *external work*.

If  $Q$  units of heat are imparted to a body, and if  $A$  be the quantity of heat which is equivalent to the unit of work; then if  $W$  is the amount of heat which serves to increase the temperature,  $I$  that required to alter the position of the molecules, and if  $L$  be the equivalent of the external work, then

$$Q = A (W + I + L).$$

286. **Expansion.**—All bodies expand by the action of heat. As a general rule, gases are the most expansible, then liquids, and lastly solids.

In solids which have definite figures, we can either consider the expansion in one dimension, or the *linear* expansion; in two dimensions, the *superficial* expansion; or in three dimensions, the *cubical* expansion or the expansion of volume, although one of these never takes place without the other. As liquids and gases have no definite figures, the expansions of volume have in them alone to be considered.

To show the linear expansion of solids, the apparatus represented in fig. 249 may be used. A metal rod,  $A$ , is fixed at one end by a screw  $B$ , while

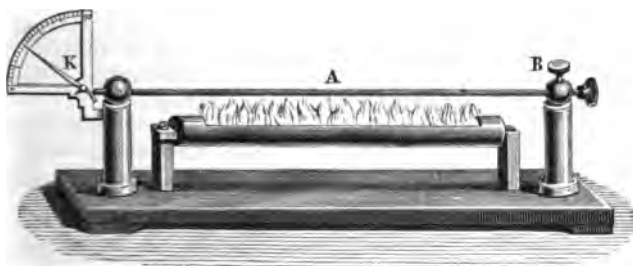

Fig. 249.

the other end presses against the short arm of an index,  $K$  which moves on a scale. Below the rod there is a sort of cylindrical lamp in which alcohol is burned. The needle  $K$  is at first at the zero point, but as the rod becomes heated, it expands, and moves the needle along the scale.

The cubical expansion of solids is shown by a *Gravesande's ring*. It consists of a brass ball  $a$  (fig. 250), which at the ordinary temperature passes freely through a ring,  $m$ , almost of the same diameter. But when the ball has been heated, it expands and no longer passes through the ring.

In order to show the expansion of liquids, a large glass bulb provided with a capillary stem is used (fig. 251). If the bulb and a part of the stem contain some coloured liquid, the liquid rapidly rises in the stem when heat

is applied, and the expansion thus observed is far greater than in the case of solids.

The same apparatus may be used for showing the expansion of gases. Being filled with air, a small thread of mercury is introduced into the capillary tube to serve as index (fig. 252). When the globe is heated in the slightest

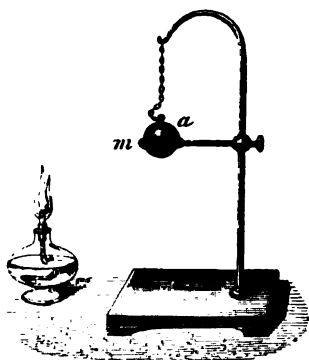

Fig. 250.

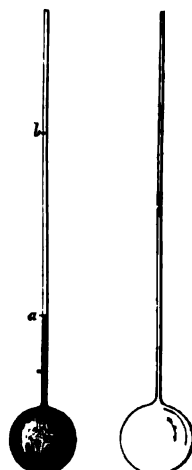

Fig. 251.

Fig. 252.

degree, even by approaching the hand, the expansion is so great that the index is driven to the end of the tube, and is finally expelled. Hence, even for a very small degree of heat, gases are highly expansible.

In these different experiments the bodies contract on cooling, and when they have attained their former temperature they resume their original volume. Certain metals, however, especially zinc, form an exception to this rule, and it appears to be also the case with some kinds of glass.

#### MEASUREMENT OF TEMPERATURE. THERMOMETRY.

287. **Temperature.**—The *temperature* or hotness of a body, independently of any hypothesis as to the nature of heat, may be defined as being the greater or less extent to which it tends to impart sensible heat to other bodies. The *temperature* of a body must not be confounded with the *quantity of heat* it possesses: a body may have a high temperature and yet have a very small quantity of heat, and conversely a low temperature and yet possess a large amount of heat. If a cup of water be taken from a bucketful, both will indicate the same temperature, yet the quantities they possess will be different. This subject of the quantity of heat will be afterwards more fully explained in the chapter on Specific Heat.

288. **Thermometer.**—*Thermometers* are instruments for measuring temperatures. Owing to the imperfections of our senses we are unable to measure temperatures by the sensation of heat or cold which they produce

in us, and for this purpose recourse must be had to the physical action of heat on bodies. These actions are of various kinds, but the expansion of bodies had been selected as the easiest to observe. But heat also produces electrical phenomena in bodies; and on these the most delicate methods of observing temperatures have been based, as we shall see in a subsequent chapter.

Liquids are best suited for the construction of thermometers—the expansion of solids being too small, and that of gases too great. Mercury and alcohol are the only liquids used—the former because it only boils at a very high temperature, and the latter because it does not solidify at the greatest known cold.

The mercurial thermometer is the most extensively used. It consists of a capillary glass tube, at the end of which is blown the *bulb*, a cylindrical or spherical reservoir. Both the bulb and a part of the stem are filled with mercury, and the expansion is measured by a scale graduated either on the stem itself, or on a frame to which it is attached.

Besides the manufacture of the bulb, the construction of the thermometer comprises three operations: the *calibration* of the tube, or its division into parts of equal capacity, the introduction of the mercury into the reservoir, and the graduation.

289. **Division of the tube into parts of equal capacity.**—As the indications of the thermometer are only correct when the divisions of the scale correspond to equal expansions of the mercury in the reservoir, the scale must be graduated so as to indicate parts of equal capacity in the tube. If the tube were quite cylindrical, and of the same diameter throughout, it would only be necessary to divide it into equal lengths. But as the diameter of glass tubes is usually greater at one end than another, parts of equal capacity in the tube are represented by unequal lengths of the scale.

In order, therefore, to select a tube of uniform calibre, a thread of mercury about an inch long is introduced into the capillary tube, and moved in different positions in the tube, care being taken to keep it at the same temperature. If the thread is of the same length in every part of the tube, it shows that the capacity is everywhere the same; but if the thread occupies different lengths the tube is rejected, and another one sought.

290. **Filling the thermometer.**—In order to fill the thermometer with mercury, a small funnel, C (fig. 253), is blown on at the top, and is filled with mercury; the tube is then slightly inclined, and the air in the bulb expanded by heating it with a spirit lamp. The expanded air partially escapes by the funnel, and on cooling, the air which remains contracts, and a portion of the mercury passes into the bulb D. The bulb is then again warmed, and allowed to cool, a fresh quantity of mercury



Fig. 253.



enters, and so on, until the bulb and part of the tube are full of mercury. The mercury is then heated to boiling; the mercurial vapours in escaping carry with them the air and moisture which remain in the tube. The tube, being full of the expanded mercury and of mercurial vapour, is hermetically sealed at one end. When the thermometer is cold, the mercury ought to fill the bulb and a portion of the stem.

291. **Graduation of the thermometer.**—The thermometer being filled, it requires to be graduated, that is, to be provided with a scale to which variations of temperature can be referred. And, first of all, two points must be fixed which represent identical temperatures and which can always be easily reproduced.

Experiment has shown that ice always melts at the same temperature whatever be the degree of heat, and that distilled water under the same pressure, and in a vessel of the same kind, always boils at the same temperature. Consequently, for the first fixed point, or zero, the temperature of melting ice has been taken: and for a second fixed point, the temperature of boiling water in a metal vessel under the normal atmospheric pressure of 760 millimetres.

This interval of temperature, that is, the range from zero to the boiling point, is taken as the unit for comparing temperatures; just as a certain length, a foot or a metre for instance, is used as a basis for comparing lengths.

292. **Determination of the fixed points.**—To obtain zero, snow or pounded ice is placed in a vessel in the bottom of which is an aperture by which water escapes (fig 254). The bulb and a part of the stem of the thermometer are immersed in this for about a quarter of an hour, and a mark made at the level of the mercury which represents zero.



Fig. 254.

The second fixed point is determined by means of the apparatus represented in the figures 255 and 256, of which 256 represents a vertical section. In both, the same letters designate the same parts. The whole of the apparatus is of brass. A central tube, A, open at both ends, is fixed on a cylindrical vessel containing water; a second tube, B, concentric with the first, and surrounding it, is fixed on the same vessel, M. In this second cylinder, which is closed at both ends, there are three tubulures, a, E, D. A cork, in which is the thermometer *t*, fits in *a*. To E, a glass tube, containing mercury, is attached, which serves as a manometer for measuring the pressure of the vapour in the

apparatus. D is an escape tube for the vapour and condensed water.

The apparatus is placed on a furnace and heated till the water boils; the vapour produced in M rises in the tube A, and passing through the two tubes in the direction of the arrows, escapes by the tubulure D. The thermometer *t* being thus surrounded with vapour, the mercury expands and when it has become stationary, the point at which it stops is marked. This

is the point sought for. The object of the second case B, is to avoid the cooling of the central tubulure by its contact with the air.

The determination of the point 100 (see next article) would seem to require that the height of the barometer during the experiment should be

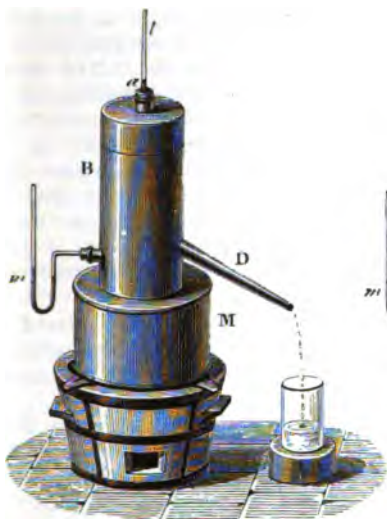

Fig. 255.

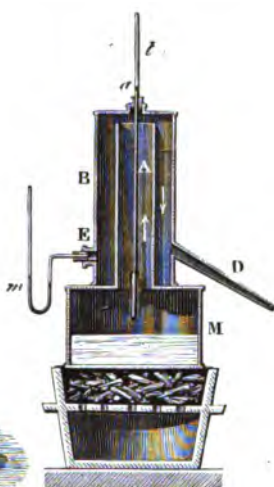

Fig. 256.

760 millimetres, for when the barometric height is greater or less than this quantity, water boils either above or below 100 degrees. But the point 100 may always be exactly obtained, by making a correction introduced by M. Biot. He found that, for every 27 millimetres difference in height of the barometer, there was a difference in the boiling point of 1 degree. If, for example, the height of the barometer is 778—that is, 18 millimetres, or two-thirds of 27, above 760—water would boil at 100 degrees and two-thirds. Consequently  $100\frac{2}{3}$  would have to be marked at the point at which the mercury stops.

Gay-Lussac observes that water boils at a somewhat higher temperature in a glass than in a metal vessel : and as the boiling point is raised by any salts which are dissolved, it has been assumed that it was necessary to use a metal vessel and distilled water in fixing the boiling point. M. Rudberg has, however, shown that these latter precautions are superfluous. The nature of the vessel, and salts dissolved in ordinary water, influence the temperature of boiling water, but not that of the vapour which is formed. That is to say, that if the temperature of boiling water from any of the above causes is higher than 100 degrees, the temperature of the vapour does not exceed 100, provided the pressure is not more than 760 millimetres. Consequently, the higher point may be determined in a vessel of any material provided the thermometer is quite surrounded by vapour, and does not dip in the water.

Even with distilled water, the bulb of the thermometer must not dip in

the liquid; for it is only the upper layer that really has the temperature of 100 degrees, since the temperature increases from layer to layer towards the bottom in consequence of the increased pressure.



Fig. 257.

293. **Construction of the scale.**—Just as the foot-rule which is adopted as the unit of comparison for length is divided into a number of equal divisions called inches for the purpose of having a smaller unit of comparison, so likewise the unit of comparison of temperatures, the range from zero to the boiling point, must be divided into a number of parts of equal capacity called *degrees*. On the Continent, and more especially in France, this space is divided into 100 parts, and this division is called the *Centigrade* or *Celsius* scale; the latter being the name of the inventor. The Centigrade thermometer is almost exclusively adopted in foreign scientific works, and as its use is gradually extending in this country, it has been and will be adopted in this book.

The degrees are designated by a small cipher placed a little above on the right of the number which marks the temperature, and to indicate temperatures below zero the minus sign is placed before them. Thus,  $-15^{\circ}$  signifies 15 degrees below zero.

In accurate thermometers the scale is marked on the stem itself (fig. 257). It cannot be displaced, and its length remains fixed, as glass has very little expansibility. The graduation is effected by covering the stem with a thin layer of wax, and then marking the divisions of the scale, as well as the corresponding numbers, with a steel point. The thermometer is then exposed for about ten minutes to the vapours of hydrofluoric acid, which attacks the glass where the wax has been removed. The rest of the wax is then removed, and the stem is found to be permanently etched.

Besides the *Centigrade* scale two others are frequently used—*Fahrenheit's scale* and *Réaumur's scale*.

In Réaumur's scale the fixed points are the same as on the Centigrade scale, but the distance between them is divided into 80 degrees, instead of into 100. That is to say, 80 degrees Réaumur are equal to 100 degrees Centigrade; one degree Réaumur is equal to  $\frac{100}{80}$  or  $\frac{5}{4}$  of a degree Centigrade, and one degree Centigrade equals  $\frac{80}{100}$  or  $\frac{4}{5}$  degrees Réaumur. Consequently to convert any number of Réaumur's degrees into Centigrade degrees (20 for example), it is merely necessary to multiply them by  $\frac{4}{5}$  (which gives 16). Similarly, Centigrade degrees are converted into Réaumur by multiplying them by  $\frac{5}{4}$ .

The thermometric scale invented by Fahrenheit in 1714 is still much used in England, and also in Holland and North America. The higher fixed point is like that of the other scales, the temperature of boiling water, but the null point or zero is the temperature obtained by mixing equal weights of sal-ammoniac and snow, and the interval between the two points is divided into 212 degrees. The zero was selected because the temperature was the lowest then known, and was thought to represent absolute cold. When Fahrenheit's thermometer is placed in melting ice it stands at 32 degrees, and therefore, 100 degrees on the Centigrade scale are equal to

180 degrees on the Fahrenheit scale, and thus 1 degree Centigrade is equal to  $\frac{9}{5}$  of a degree Fahrenheit, and inversely 1 degree Fahrenheit is equal to  $\frac{5}{9}$  of a degree Centigrade.

If it be required to convert a certain number of Fahrenheit degrees (95, for example) into Centigrade degrees, the number 32 must first be subtracted in order that the degrees may count from the same part of the scale. The remainder in the example is thus 63, and as 1 degree Fahrenheit is equal to  $\frac{5}{9}$  of a degree Centigrade, 63 degrees are equal to  $63 \times \frac{5}{9}$  or 35 degrees Centigrade.

If  $F$  be the given temperature in Fahrenheit degrees and  $C$  the corresponding temperature in Centigrade degrees, the former may be converted into the latter by means of the formula

$$(F - 32) \frac{5}{9} = C,$$

and conversely, Centigrade degrees may be converted into Fahrenheit by means of the formula

$$\frac{9}{5}C + 32 = F.$$

These formulæ are applicable to all temperatures of the two scales, provided the signs are taken into account. Thus, to convert the temperature of 5 degrees Fahrenheit into Centigrade degrees, we have

$$(5 - 32) \frac{5}{9} = \frac{-27 \times 5}{9} = -15 \text{ C.}$$

In like manner we have, for converting Réaumur into Fahrenheit degrees, the formula

$$\frac{9}{4}R + 32 = F,$$

and conversely, for changing Fahrenheit into Réaumur degrees, the formula

$$(F - 32) \frac{4}{9} = R.$$

**294. Displacement of zero.**—Thermometers, even when constructed with the greatest care, are subject to a source of error which must be taken into account: this is, that in course of time the zero tends to rise, the displacement sometimes extending to as much as two degrees; so that when the thermometer is immersed in melting ice it no longer sinks to zero.

This is generally attributed to a diminution of the volume of the bulb and also of the stem, occasioned by the pressure of the atmosphere. It is usual with very accurate thermometers to fill them two or three years before they are graduated.

Besides this slow displacement, there are often variations in the position of the zero, when the thermometer has been exposed to high temperatures, caused by the fact that the bulb and stem do not contract on cooling to their original volume (286), and hence it is necessary to verify the position of zero when a thermometer is used for delicate determinations.

Regnault has found that some mercurial thermometers, which agree at  $0^\circ$  and at  $100^\circ$ , differ between these points, and that these differences frequently amount to several degrees. Regnault thinks that this is due to the unequal expansion of different kinds of glass.

**295. Limits to the employment of mercurial thermometers.**—Of all thermometers in which liquids are used, the one with mercury is the most

useful, because this liquid expands most regularly, and is easily obtained pure, and because its expansion between  $-36^{\circ}$  and  $100^{\circ}$  is *regular*, that is, proportional to the degree of heat. It also has the advantage of having a very low specific heat. But for temperatures below  $-36^{\circ}$  C. the alcohol thermometer must be used, since mercury solidifies at  $-40^{\circ}$  C. Above  $100$  degrees the coefficient of expansion increases and the indications of the mercurial thermometers are only approximate, the error arising sometimes to several degrees. Mercury thermometers also cannot be used for temperatures above  $350^{\circ}$ , for this is the boiling point of mercury.

296. **Alcohol thermometer.**—The *alcohol thermometer* differs from the mercury thermometer in being filled with coloured alcohol. But as the expansion of liquids is less regular in proportion as they are near the boiling point, alcohol, which boils at  $78^{\circ}$  C., expands very irregularly. Hence, alcohol thermometers are usually graduated by placing them in baths at different temperatures together with a standard mercurial thermometer, and marking on the alcohol thermometer the temperature indicated by the mercury thermometer. In this manner the alcohol thermometer is comparable with the mercury one; that is to say, it indicates the same temperatures under the same conditions. The alcohol thermometer is especially used for low temperatures, for it does not solidify at the greatest known cold.

297. **Conditions of the delicacy of a thermometer.**—A thermometer may be delicate in two ways :—1. When it indicates very small changes of temperature. 2. When it quickly assumes the temperature of the surrounding medium.

The first object is attained by having a very narrow capillary tube and a very large bulb; the expansion of the mercury on the stem is then limited to a small number of degrees, from 10 to 20 or 20 to 30 for instance, so that each degree occupies a great length on the stem, and can be subdivided into very small fractions. The second kind of delicacy is obtained by making the bulb very small, for then it rapidly assumes the temperature of the liquid in which it is placed.

A good mercury thermometer should answer to the following tests: When its bulb and stem, to the top of the column of mercury, are immersed in melting ice, the top of the mercury should exactly indicate  $0^{\circ}$  C.; and when suspended with its bulb and scale immersed in the steam of water boiling in a metal vessel (as in fig. 255), the barometer standing at 760 mm., the mercury should be stationary at  $100^{\circ}$  C. When the instrument is inverted, the mercury should fill the tube, and fall with a metallic click, thus showing the complete exclusion of air. The value of the degrees should be uniform: to ascertain this, a little cylinder of mercury may be detached from the column by a slight jerk, and on inclining the tube it may be made to pass from one portion of the bore to another. If the scale be properly graduated, the column will occupy an equal number of degrees in all parts of the tube.

298. **Differential thermometer.**—Sir John Leslie constructed a thermometer for showing the difference of temperature of two neighbouring places, from which it has received the name *differential thermometer*.

A modified form of it is that devised by Matthiessen (fig. 258), which has the advantage of being available for indicating the temperature of liquids. It consists of a bent glass tube, each end of which is bent twice, and ter-

minates in a bulb; the bulbs being pendent can be readily immersed in a liquid. The bend contains some coloured liquid, and in a tube which connects the two limbs is a stopcock, by which the liquid in each limb is easily brought to the same level. The whole is supported by a frame.

When one of the bulbs is at a higher temperature than the other, the liquid in the stem is depressed, and rises in the other stem.

The instrument is now only used as a *thermoscope*, that is to indicate a difference of temperature between the two bulbs and not to measure its amount.

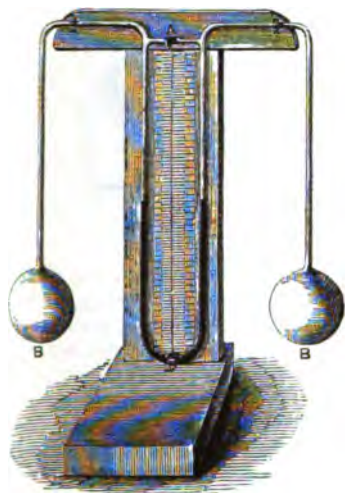

Fig. 258.



Fig. 259.

299. **Breguet's metallic thermometer.**—Breguet invented a thermometer founded on the unequal expansion of metals, and remarkable for its delicacy. It consists of three strips of platinum, gold, and silver, which are passed through a rolling mill so as to form a very thin metallic ribbon. This is then coiled in a spiral form, as seen in fig. 259, and one end being fixed to a support, a light needle is fixed to the other, which is free to move round a graduated scale.

Silver, which is the most expansible of the metals, forms the internal face of the spiral, and platinum the external. When the temperature rises, the silver expands more than the gold or platinum, the spiral unwinds itself, and the needle moves from left to right of the above figure. The contrary effect is produced when the temperature sinks. The gold is placed between the other two metals, because its expansibility is intermediate between that of the silver and the platinum. Were these two metals employed alone, their rapid unequal expansion might cause a fracture. Breguet's thermometer is graduated in Centigrade degrees, by comparing it with a standard mercury thermometer.

300. **Rutherford's maximum and minimum thermometers.**—It is necessary, in meteorological observations, to know the highest temperature

of the day and the lowest temperature of the night. Ordinary thermometers could only give these indications by a continuous observation, which would be impracticable. Several instruments have accordingly been invented for this purpose, the simplest of which is Rutherford's. On a rectangular piece of plate-glass (fig. 260) two thermometers are fixed, whose stems are bent

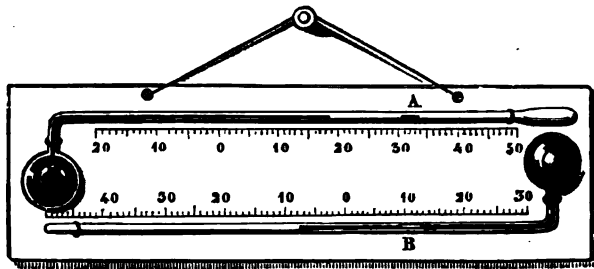

Fig. 260.

horizontally. The one, A, is a mercury, and the other, B, an alcohol thermometer. In A there is a minute piece of iron wire, A, moving freely in the tube, which serves as an index. The thermometer being placed horizontally, when the temperature rises the mercury pushes the index before it. But as soon as the mercury contracts, the index remains in that part of the tube to which it has been moved, for there is no adhesion between the iron and the mercury. In this way the index registers the highest temperature which has been attained; in the figure this is  $31^{\circ}$ . In the minimum thermometer there is a small hollow glass tube which serves as index. When it is at the end of the column of liquid, and the temperature falls, the column contracts, and carries the index with it, in consequence of adhesion, until it has reached the greatest contraction. When the temperature rises the alcohol expands, and passing between the sides of the tube and the index, does not displace B. The position of the index gives therefore the lowest temperature which has been reached; in the figure this is  $9\frac{1}{2}$  degrees below zero.

301. **Pyrometers.**—The name *pyrometers* is given to instruments for measuring temperatures so high that mercurial thermometers could not be used. The older contrivances for this purpose, Wedgwood's, Daniell's (which in principle resembled the apparatus in fig. 247), Brongniart's, etc., are gone entirely out of use. None of them give an exact measure of temperature. The arrangements now used for the purpose are either based on the expansion of gases and vapours, or on the electrical properties of bodies, and will be subsequently described.

302. **Different remarkable temperatures.**—The following table gives some of the most remarkable points of temperature. It may be observed, that it is easier to produce very high temperatures than very low degrees of cold.

Greatest artificial cold produced by a bath of bisulphide of carbon and liquid nitrous acid . . . . .	-140° C
Greatest cold produced by ether and liquid carbonic acid	-110
Greatest natural cold recorded in Arctic expeditions .	- 58·7
Mercury freezes . . . . .	- 39·4
Mixture of snow and salt . . . . .	- 20
Ice melts . . . . .	0
Greatest density of water . . . . .	+ 4
Mean temperature of London . . . . .	9·9
Blood heat . . . . .	36·6
Water boils . . . . .	100
Mercury boils . . . . .	350
Sulphur boils . . . . .	440
Red heat (just visible) (Daniell) . . . . .	526
Silver melts . . . . .	1000
Zinc boils . . . . .	1040
Cast iron melts . . . . .	1530
Highest heat of wind furnace „ . . . . .	1800

## CHAPTER II.

## EXPANSION OF SOLIDS.

303. **Linear expansion and cubical expansion. Coefficients of expansion.**—It has been already explained that in solid bodies the expansion may be according to three dimensions—linear, superficial, and cubical.

The *coefficient of linear expansion* is the elongation of the unit of length of a body when its temperature rises from zero to 1 degree; the *coefficient of superficial expansion* is the increase of the surface in being heated from zero to 1 degree, and the *coefficient of cubical expansion* is the increase of the unit of volume under the same circumstances.

These coefficients vary with different bodies, but for the same body the *coefficient of cubical expansion is three times that of the linear expansion*, as is seen from the following considerations. Suppose a cube, the length of whose side is 1 at zero. Let  $k$  be the elongation of this side in passing from zero to 1 degree, its length at 1 degree will be  $1+k$ , and the volume of the cube, which was 1 at zero, will be  $(1+k)^3$ , or  $1+3k+3k^2+k^3$ . But as the elongation  $k$  is always a very small fraction (see table, art. 305), its square  $k^2$ , and still more its cube  $k^3$ , are so small that they may be neglected, and the value at 1 degree becomes very nearly  $1+3k$ . Consequently, the increase of volume is  $3k$ , or thrice the coefficient of linear expansion.

In the same manner it may be shown that the coefficient of superficial expansion is double the coefficient of linear expansion.

304. **Measurement of the coefficient of linear expansion. Lavoisier and Laplace's method.**—The apparatus used by Lavoisier and Laplace for determining the coefficients of linear expansion (fig. 261) consists of a brass



trough, placed on a furnace between four stone supports. On the two supports on the right hand, there is a horizontal axis, at the end of which is a telescope; on the middle of this axis, and at right angles to it, is fixed a glass rod, turning with it, as does also the telescope. The other two supports are joined by a cross piece of iron, to which another glass rod is fixed, also

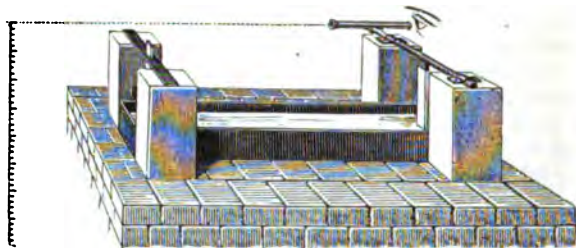

Fig. 261.

at right angles. The trough, which contains oil or water, is heated by a furnace not represented in the figure, and the bar whose expansion is to be determined is placed in it.

Fig. 262 represents a section of the apparatus; G is the telescope, KH the bar, whose ends press against the two glass rods F and D. As the rod F is fixed, the bar can only expand in the direction KH, and in order to

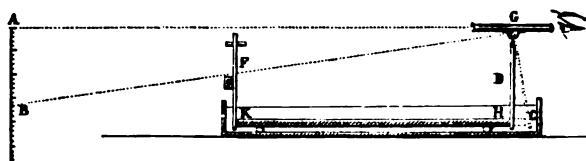

Fig. 262.

eliminate the effects of friction it rests on two glass rollers. Lastly, the telescope has a cross-wire in the eyepiece, which, when the telescope moves, indicates the depression by the corresponding number of divisions on a vertical scale AB, at a distance of 220 yards.

The trough is first filled with ice, and the bar being at zero, the division on the scale AB, corresponding to the wire of the telescope, is read off. The ice having been removed, the trough is filled with oil or water, which is heated to a given temperature. The bar then expands, and when its temperature has become stationary, which is determined by means of thermometers, the division of the scale, seen through the telescope, is read off.

From these data the elongation of the bar is determined; for since it has become longer by a quantity, CH, and the optical axis of the telescope has become inclined in the direction GB, the two triangles, GHC and ABG, are similar, for they have the sides at right angles each to each, so that  $\frac{HC}{AB} = \frac{GH}{AG}$ . In the same way, if HC' were another elongation, and AB' a

corresponding deviation, there would still be  $\frac{HC'}{AB'} = \frac{GH}{AG}$ ; from which it follows that the ratio between the elongation of the bar and the deflection of the telescope is constant, for it is always equal to  $\frac{GH}{AG}$ . A preliminary

measurement had shown that this ratio was  $\frac{1}{744}$ . Consequently,  $\frac{HC}{AB} = \frac{1}{744}$ ,

whence  $HC = \frac{AB}{744}$ ; that is, the total elongation of the bar is obtained by dividing the length on the scale traversed by the cross wire by 744. Dividing this elongation by the length of the bar, and then by the temperature of the bath, the quotient is the dilatation for the unit of length and for a single degree—in other words, the coefficient of linear dilatation.

305. **Roy and Ramsden's method.**—Lavoisier and Laplace's method is founded on an artifice which is frequently adopted in physical determinations, and which consists in amplifying by a known amount dimensions which, in themselves, are too small to be easily measured. Unfortunately this plan is

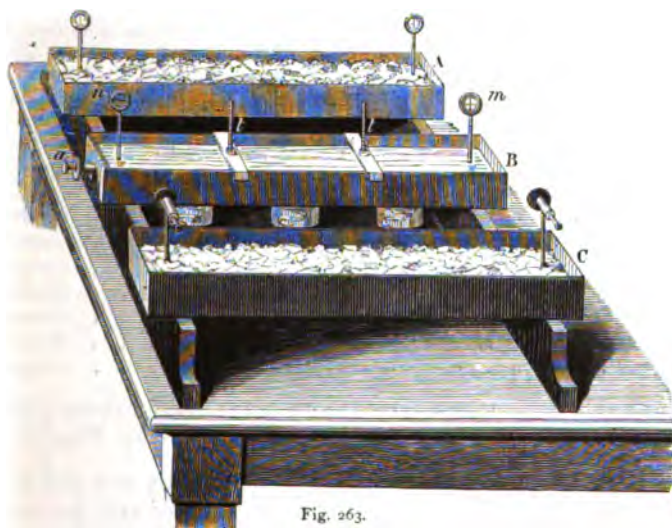

Fig. 263.

often more fallacious than profitable, for it is first necessary to determine the ratio of the motion measured to that on which it depends. In the present case it is necessary to know the lengths of the arms of the lever in the apparatus. But this preliminary operation may introduce errors of such importance as partially to counterbalance the advantage of great delicacy. The following method, which was used by General Roy in 1787, and which was devised by Ramsden, depends on another principle. It measures the elongations directly, and without amplifying them; but it measures them by means of a micrometer, which indicates very small displacements.

The apparatus (fig. 263) consists of three parallel metal troughs about 6

feet long. In the middle one there is a bar of the body whose expansion is to be determined, and in the two others are cast-iron bars of exactly the same length as this bar. Rods are fixed vertically on both ends of these three bars. On the rods in the troughs A and B there are rings with cross-wires like those of a telescope. On the rods in the trough C are small telescopes also provided with cross-wires.

The troughs being filled with ice, and all three bars at zero, the points of intersection of the wires in the disc, and of the wires in the telescope, are all in a line at each end of the bar. The temperature in the middle trough is then raised to  $100^{\circ}$  C. by means of spirit lamps placed beneath the trough; the bar expands, but as it is in contact with the end of a screw, *a*, fixed on the side, all the elongation takes place in the direction *nm*, and as the cross-wire *n* remains in position, the cross-wire *m* is moved towards B by a quantity equal to the elongation. But since the screw *a* is attached to the bar, by turning it slowly from right to left, the bar is moved in the direction *mn*, and the cross-wire *m* regains its original position. To effect this, the screw has been turned by a quantity exactly equal to the elongation of the bar, and as this advance of the screw is readily deduced from the number of turns of its *thread* (11), the total expansion of the bar is obtained, which, divided by the temperature of the bath, and this quotient by the length of the bar at zero, gives the coefficient of linear expansion.

306. **Coefficients of linear expansion.**—By one or the other method the following results have been obtained.

*Coefficients of linear expansion for  $1^{\circ}$  between  $0^{\circ}$  and  $100^{\circ}$  C.*

White glass . . . . .	0'000008613	Copper . . . . .	0'000017182
Platinum . . . . .	0'000008842	Bronze . . . . .	0'000018167
Untempered steel . . . . .	0'000010788	Brass . . . . .	0'000018782
Cast iron . . . . .	0'000011250	Silver . . . . .	0'000019097
Wrought iron . . . . .	0'000012204	Tin . . . . .	0'000021730
Tempered steel . . . . .	0'000012395	Lead . . . . .	0'000028575
Gold . . . . .	0'000014660	Zinc . . . . .	0'000029417

From what has been said about the linear expansion (303), the coefficients of cubical expansion of solids are obtained by multiplying those of linear expansion by three.

The coefficients of the expansion of the metals vary with their physical condition, being different for the same metal according as it has been cast or hammered and rolled, hardened or annealed. As a general rule, operations which increase the density increase also the rate of expansion. But even for substances in apparently the same condition, different observers have found very unequal amounts of expansions; this may arise in the case of compound substances, such as glass, brass, or steel, from a want of uniformity in chemical composition, and in simple bodies from slight differences of physical state.

The expansion of amorphous solids, and of those which crystallise in the regular system, is the same for all dimensions, unless they are subject to a strain in some particular direction. A fragment of such a substance varies in bulk, but retains the same shape. Crystals not belonging to the regular

system exhibit, when heated, an unequal expansion in the direction of their different axes, in consequence of which the magnitude of their angles, and therefore their form, is altered. In the dimetric system the expansion is the same in the direction of the two equal axes, but different in the third. In crystals belonging to the hexagonal system the expansion is the same in the direction of the three secondary axes, but different from that according to the principal one. In the trimetric system it is different in all three directions.

To the general law that all bodies expand by heat there is an important exception in the case of iodide of silver, which contracts somewhat when heated. It has a negative coefficient of expansion the value of which is 000000139.

Fizeau has determined the expansion of a great number of crystallised bodies by an optical method. He placed thin plates of the substance on a glass plate and let yellow light pass through them. He thus obtained alternately yellow and dark Newton's rings (*q.v.*). On heating, the plate of the substance expanded, the thin layer of air became thinner, and the position of the rings was altered. From the alteration in their position the amount of the expansion could be deduced. Among the results he has obtained is the curious one, that certain crystallised bodies, such as diamond, emerald, and cupric oxide, contract on being cooled to a certain temperature, but as the cooling is continued below this temperature they expand. They have thus a temperature of maximum density, as is the case with water (319). In the case of emerald and cuprous oxide this temperature is at  $-4.2^{\circ}$ , in the case of diamond at  $-42.3^{\circ}$ .

307. **The coefficients of expansion increase with the temperature.**—According to Dr. Mathiessen, who determined the expansion of the metals and alloys by weighing them in water at different temperatures, the coefficients of expansion are not quite regular between  $0^{\circ}$  and  $100^{\circ}$ . He found the following values for the linear expansion between  $0^{\circ}$  and  $100^{\circ}$ :—

Zinc . . . . .	$L_t = L_0 (1 + 0.00002741 t + 0.0000000235 t^2)$
Lead . . . . .	$L_t = L_0 (1 + 0.00002726 t + 0.0000000074 t^2)$
Silver . . . . .	$L_t = L_0 (1 + 0.00001809 t + 0.0000000135 t^2)$
Copper . . . . .	$L_t = L_0 (1 + 0.00001408 t + 0.0000000264 t^2)$
Gold . . . . .	$L_t = L_0 (1 + 0.00001358 t + 0.0000000112 t^2)$

The same authority has found that alloys expand very nearly according to the following law: 'the coefficients of expansion of an alloy are equal to the mean of the coefficients of expansion of the volumes of the metals composing it.'

308. **Formule relative to the expansion of solids.**—Let  $l$  be the length of a bar at zero,  $l'$  its length at the temperature  $t^{\circ}$  C., and  $a$  its coefficient of linear expansion. The tables usually give the expansion for  $1^{\circ}$  between  $0^{\circ}$  and  $100^{\circ}$ , as in article 306, or for  $100^{\circ}$ ; in this latter case  $a$  is obtained by dividing the number by 100.

The relation existing between the above quantities is expressed by a few simple formulæ.

The elongation corresponding to  $t^{\circ}$  is  $t$  times  $a$  or  $at$  for a single unit of

length, or  $all$  for  $l$  units. The length of the bar which is  $l$  at zero is  $l + all$  at  $t$ , consequently,

$$l' = l + all = l(1 + at)$$

This formula gives the length of a body  $l'$  at  $t^\circ$ , knowing its length  $l$  at zero, and the coefficient of expansion  $a$ ; and by simple algebraical transformations we can obtain from it formulæ for the length at zero, knowing the length  $l'$  at  $t^\circ$ , and also for finding  $a$  the coefficient of linear expansion, knowing the lengths  $l'$  and  $l$  at  $t^\circ$  and zero respectively.

It is obvious that the formulæ for cubical expansion are entirely analogous to the preceding.

The following are examples of the application of these formulæ :—

(i.) A metal bar has a length  $l'$  at  $t^\circ$ , what will be its length  $l$  at  $t^\circ$ ?

From the above formula we first get the length of the given bar at zero, which is  $\frac{l'}{1 + at'}$ ; by means of the same formula we pass from zero to  $t^\circ$  in multiplying by  $1 + at$ , which gives for the desired length the formula

$$l = \frac{l'(1 + at)}{1 + at'}$$

(ii.) The density of a body being  $d$  at zero, required its density  $d'$  at  $t^\circ$ .

If  $V$  be the volume of the body at zero, and  $D$  its coefficient of cubical expansion the volume at  $t$  will be  $V + DtV$ , and as the density of a body is in inverse ratio of the volume which the body assumes in expanding, we get the inverse proportion,

$$d' : d = V : V + DtV,$$

$$\frac{d'}{d} = \frac{1}{1 + Dt}; \text{ or } d' = \frac{d}{1 + Dt}.$$

Consequently, when a body is heated from 0 to  $t^\circ$ , its density, and therefore its weight for an equal volume, is inversely as the binomial expression,  $1 + Dt$ .

309. **Applications of the expansion of solids.**—In the arts we meet with numerous examples of the influence of expansion. (i.) The bars of furnaces must not be fitted tightly at their extremities, but must, at least, be free at one end, otherwise, in expanding they would split the masonry. (ii.) In making railways a small space is left between the successive rails, for if they touched, the force of expansion would cause them to curve or would break the chairs. (iii.) Water-pipes are fitted to one another by means of telescope joints, which allow room for expansion. (iv.) If a glass is heated or cooled too rapidly it cracks; this arises from the fact that glass is a bad conductor of heat, the sides become unequally heated, and consequently unequally expanded, which causes a fracture.

When bodies have been heated to a high temperature, the force produced by their contraction on cooling is very considerable; it is equal to the force which is needed to compress or expand the material to the same extent by mechanical means. According to Barlow, a bar of malleable iron a square inch in section is stretched  $\frac{1}{10000}$ th of its length by a weight of a ton; the same increase is experienced by about  $9^\circ$  C. A difference of  $45^\circ$  C. between the cold of winter and the heat of summer is not unfrequently

experienced in this country. In that range, a wrought-iron bar ten inches long will vary in length by  $\frac{1}{300}$ th of an inch and will exert a strain, if its ends are securely fastened, of fifty tons. It has been calculated from Joule's data that the force exerted by heat in expanding a pound of iron between  $0^{\circ}$  and  $100^{\circ}$ , during which it increases about  $\frac{1}{280}$ th of its bulk, is equal to 16,000 foot-pounds; that is, it could raise a weight of 7 tons through a height of one foot.

(i.) An application of this contractile force is seen in the mode of securing tires on wheels. The tire being made red hot, and thus considerably expanded, is placed on the circumference of the wheel and then cooled. The tire, when cold, embraces the wheel with such force as not only to secure itself on the rim, but also to press home the joints of the spokes into the felloes and nave. (ii.) Another interesting application was made in the case of a gallery at the Conservatoire des Arts et Métiers in Paris, the walls of which had begun to bulge outwards. Iron bars were passed across the building and screwed into plates on the outside of the walls. Each alternate bar was then heated by means of lamps, and when the bar had expanded it was screwed up. The bars being then allowed to cool contracted, and in so doing drew the walls together. The same operation was performed on the other bars.



Fig. 264.

310. **Compensation pendulum.**—An important application of the expansion of metals has been made in the *compensation pendulum*. This is a pendulum in which the elongation, when the temperature rises, is so compensated that the distance between the centre of suspension and the centre of oscillation (80) remains constant, which, from the laws of the pendulum (81), is necessary for isochronous oscillations, and in order that the pendulum may be used as a regulator of clocks.

In fig. 264, which represents the *gridiron* pendulum, one of the commonest forms of compensation pendulum, the ball, L, instead of being supported by a single rod, is supported by a framework, consisting of alternate rods of steel and brass. In the figure, the shaded rods represent steel; including a small steel rod, *b*, which supports the whole of the apparatus, there are six of them. The rest of the rods, four in number, are of brass. The rod *i*, which supports the ball, is fixed at its upper end to a horizontal cross-piece; at its lower end it is free, and passes through the two circular holes in the lower horizontal cross-pieces.

Now it is easy to see from the manner in which the vertical rods are

fixed to the cross-pieces, that the elongation of the steel rods can only take place in a downward direction, and that of the brass rods in an upward direction. Consequently, in order that the pendulum may remain of the same length, it is necessary that the elongation of the brass rods shall tend to make the ball rise by exactly the same quantity that the elongation of the steel rod tends to lower it : a result which is attained when the sum of the lengths of the steel rods A is to the sum of the lengths of the brass rods B in the inverse ratio of the coefficients of expansion of steel and brass,  $a$  and  $b$ , that is, in the proportion  $A : B = b : a$ .

The elongation of the rod may also be compensated for by means of *compensating strips*. These consist of two blades of copper and iron

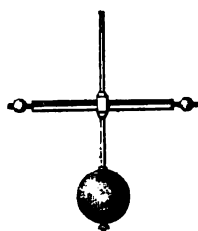

Fig. 265.

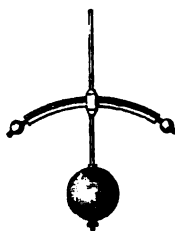

Fig. 266

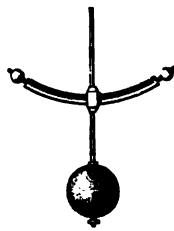

Fig. 267.

soldered together and fixed to the pendulum rod, as represented in fig. 265. The copper blade, which is more expansible, is below the iron. When the temperature sinks, the pendulum rod becomes shorter, and the ball rises. But at the same time the compensating strips become curved, as seen in fig. 266, in consequence of the copper contracting more than the iron, and two metallic balls at their extremities become lower. If they have the proper size in reference to the pendulum ball, the parts which tend to remove from it, and the centre of suspension-compensate those which tend to approach it, and the centre of oscillation is not displaced. If the temperature rises, the pendulum ball descends, but at the same time the small balls ascend, as shown in fig. 267, so that there is always compensation.

One of the most simple compensating pendulums is the *mercury pendulum*, invented by an English watchmaker, Graham. The ball of the pendulum, instead of being solid, consists of a glass cylinder, containing pure mercury, which is placed in a sort of stirrup, supported by a steel rod. When the temperature rises the rod and stirrup become longer, and thus lower the centre of gravity ; but at the same time the mercury expands, and, rising in the cylinder, produces an inverse effect, and as mercury is much more expansible than steel, a compensation may be effected without making the mercurial vessel of undue dimensions.

The same principle is applied in the *compensating balances* of chronometers. The motion here is regulated by a *balance* or wheel, furnished with a spiral spring, and the time of the chronometer depends on the force of the spring, the mass of the balance, and on its circumference. Now when the temperature rises the circumference increases, and the chronometer goes slower ; and to prevent this, part of the mass must be brought nearer the

axis. On the circumference of the balance compensating strips are fixed, of which the more expansible metal is on the outside, and at the end of these are small masses of metal which play the same part as the balls in the above case. When the radius is expanded by heat, the small masses are brought nearer the centre in consequence of the curvature of the strips; and as they can be fixed in any position, they are easily arranged so as to compensate for the expansion of the balance.

## CHAPTER III.

## EXPANSION OF LIQUIDS.

311. **Apparent and real expansion.**—If a flask of thin glass, provided with a narrow stem, the flask and part of the stem being filled with some coloured liquid, be immersed in hot water, fig. 268, the column of liquid in the stem at first sinks from *b* to *a*, but then immediately after rises, and continues to do so until the liquid inside has the same temperature as the hot water. This first sinking of the liquid is not due to its contraction; it arises from the expansion of the glass, which becomes heated before the heat can reach the liquid; but the expansion of the liquid soon exceeds that of the glass, and the liquid ascends.



Fig. 268.

Hence in the case of liquids we must distinguish between the *apparent* and the *real* or *absolute* expansion. The apparent expansion is that which is actually observed when liquids contained in vessels are heated; the *absolute* expansion is that which would be observed if the vessel did not expand; or, as this is never the case, it is the apparent expansion corrected for the simultaneous expansion of the containing vessel.

As has been already stated, the cubical expansion of liquids is alone considered; and as in the case of solids, the *coefficient of expansion* of a liquid is the increase of the unit of volume for a single degree, but a distinction is here made between the *coefficient of absolute expansion* and the *coefficient of apparent expansion*. Of the many methods which have been employed for determining these two coefficients, we shall describe that of Dulong and Petit.

312. **Coefficient of the absolute expansion of mercury.**—In order to determine the coefficient of the absolute expansion of mercury, the influence of the envelope must be eliminated. Dulong and Petit's method depends on the hydrostatical principle that, in two communicating vessels, the heights of two columns of liquid in equilibrium are inversely as their densities (108), a principle independent of the diameters of the vessels, and therefore of their expansions.



The apparatus consists of two glass tubes, A and B (fig. 269), joined by a capillary tube, and kept vertical on an iron support, KM, the horizontality of which is adjusted by means of two levelling screws and two spirit levels, *m* and *n*. Each of the tubes is surrounded by a metal case, of which the smaller, D, is filled with ice; the other, E, containing oil, can be heated by the furnace, which is represented in section so as to show the case: Mercury is poured into the tubes A and B; it remains at the same level in both, as

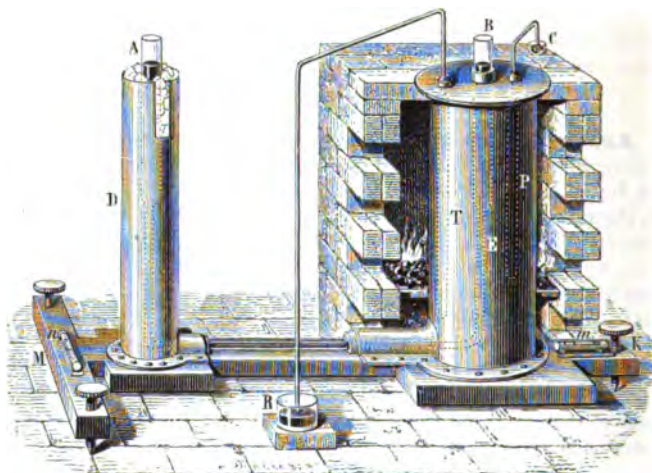

Fig. 269.

long as they are at the same temperature, but rises in B in proportion as it is heated, and expands.

Let  $h$  and  $d$  be the height and density of the mercury in the leg A, at the temperature zero, and  $h'$  and  $d'$  the same quantities in the leg B. From the hydrostatical principle previously cited we have had  $hd = h'd'$ . Now from the problem in article 308,  $d' = \frac{d}{1 + Dt}$ ,  $D$  being the coefficient of absolute expansion of mercury; substituting this value of  $d'$  in the equation, we have  $\frac{h'd}{1 + Dt} = hd$ , from which we get  $D = \frac{h' - h}{ht}$ .

The coefficient of absolute expansion of mercury is obtained from this formula, knowing the heights  $h'$  and  $h$ , and the temperature  $t$  of the bath in which the tube B is immersed. In Dulong and Petit's experiment this temperature was measured by a weight thermometer, P (314), the mercury of which overflowed into the basin, C, and by means of an air thermometer, T (323); the heights  $h'$  and  $h$  were measured by a cathetometer, K (89).

Dulong and Petit found by this method that the coefficient of absolute expansion of mercury, between  $0^\circ$  and  $100^\circ$  C. is  $\frac{1}{55550}$ . But they found that the coefficient increased with the temperature. Between  $100^\circ$  and  $200^\circ$  it is  $\frac{1}{5425}$ , and between  $200^\circ$  and  $300^\circ$  it is  $\frac{1}{5300}$ . The same observation

has been made in reference to other liquids, showing that their expansion is not regular. It has been found that this expansion is less regular in proportion as liquids are near a change in their state of aggregation, that is, approach their freezing or boiling points. Dulong and Petit found that the expansion of mercury between  $-36^{\circ}$  and  $100^{\circ}$  is practically quite uniform.

Regnault, who has determined this important physical constant, has found that the mean coefficient between  $0^{\circ}$  and  $100^{\circ}$  is  $\frac{1}{8508}$ , between  $100^{\circ}$  and  $200^{\circ}$ ,  $\frac{1}{8574}$ , and between  $200^{\circ}$  and  $300^{\circ}$ ,  $\frac{1}{8514}$ .

**313. Coefficient of the apparent expansion of mercury.**—The coefficient of apparent expansion of a liquid varies with the nature of the envelope. That of mercury in glass was determined by means of the apparatus represented in figure 270. It consists of a glass cylinder to which is joined a bent capillary glass tube, open at the end.

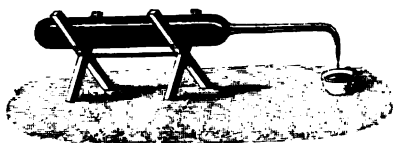

Fig. 270.

The apparatus is weighed first empty, and then when filled with mercury at zero; the difference gives the weight of the mercury,  $P$ . It is then raised to a known temperature,  $t$ ; the mercury expands, a certain quantity passes out, which is received in the capsule and weighed. If the weight of this mercury be  $p$ , that of the mercury remaining in the apparatus will be  $P - p$ .

When the temperature is again zero, the mercury in cooling produces an empty space in the vessel, which represents the contraction of the weight of mercury  $P - p$ , from  $t^{\circ}$  to zero, or, what is the same thing, the expansion of the same weight from 0 to  $t^{\circ}$ , that is the weight  $p$  represents the expansion of the weight  $P - p$ , for  $t^{\circ}$ . If this weight expands in glass by a quantity  $p$  for  $t^{\circ}$ , a single unit of weight would expand  $\frac{p}{(P - p)}$  for  $t^{\circ}$  and  $\frac{p}{(P - p)t}$  for a single degree; consequently, for  $D^{\circ}$ , the coefficient of ap-

parent expansion of mercury in glass, we have  $D' = \frac{p}{(P - p)t}$ . Dulong and Petit found the coefficient of apparent expansion of mercury in glass to be  $\frac{1}{8480}$ .

**314. Weight thermometer.**—The apparatus represented in fig. 270 is called the *weight thermometer*, because the temperature can be deduced from the weight of mercury which overflows.

The above experiments have placed the coefficient of apparent expansion at  $\frac{1}{8480}$ ; we have therefore the equation  $\frac{p}{(P - p)t} = \frac{1}{8480}$ , from which we get  $t = \frac{6480p}{P - p}$ , a formula which gives the temperature  $t$  when the weights  $P$  and  $p$  are known.

**315. Coefficient of the expansion of glass.**—As the absolute expansion of a liquid is the apparent expansion plus the expansion due to the envelope, the coefficient of the cubical expansion of glass has been obtained by taking

the difference between the coefficient of absolute expansion of mercury in glass and that of its apparent expansion. That is, the coefficient of cubical expansion of glass is

$$\frac{1}{8808} - \frac{1}{8480} = \frac{1}{33700} = 0\cdot002584.$$

Regnault has found that the coefficient of expansion varies with different kinds of glass, and further with the shape of the vessel. For ordinary chemical glass tubes, the coefficient is 0\cdot0000254.

316. **Coefficients of expansion of various liquids.**—The apparent expansion of liquids may be determined by means of the weight thermometer, and the absolute expansion is obtained by adding to this coefficient the expansion of the glass.

*Total apparent expansions of liquids between 0 and 100° C.*

Mercury . . . . .	0\cdot01543	Oil of turpentine . . . . .	0\cdot07
Distilled water . . . . .	0\cdot0466	Ether . . . . .	0\cdot07
Water saturated with salt . . . . .	0\cdot05	Fixed oils . . . . .	0\cdot08
Sulphuric acid . . . . .	0\cdot06	Nitric acid . . . . .	0\cdot11
Hydrochloric acid . . . . .	0\cdot06	Alcohol . . . . .	0\cdot116

The coefficient of apparent expansion for 1° C. is obtained by dividing these numbers by 100; but the number thus obtained does not represent the mean coefficient of expansion of liquids, for the expansion of these bodies increases gradually from zero. The expansion of mercury is practically constant between -36° and 100° C., while water contracts from zero to 4°, and then expands.

For many physical experiments a knowledge of the exact expansion of water is of great importance. This physical constant was determined with great care by Dr. Matthiessen, who found that between 4° and 32° it may be expressed by the formula

$$Vt = 1 - 0\cdot00000253(t-4) + 0\cdot000008389(t-4)^2 + 0\cdot0000007173(t-4)^3;$$

and between 30° and 100° by

$$Vt = 0\cdot999695 + 0\cdot000054724t^2 + 0\cdot0000001126t^3.$$

Many liquids, with low boiling points, especially condensed gases, have very high coefficients of expansion. Thilorier found that liquid carbonic acid expands four times as much as air. Drion has recently confirmed this observation, and has obtained analogous results with chloride of ethyle, liquid sulphurous acid, and liquid hyponitrous acid.

317. **Correction of the barometric height.**—It has been already explained under the Barometer (164), that, in order to make the indications of this instrument comparable in different places and at different times, they must be reduced to a uniform temperature, which is that of melting ice. The correction is made in the following manner:—

Let  $H$  be the barometric height at  $t^\circ$ , and  $h$  its height at zero,  $d$  the density of mercury at zero, and  $d'$  its density at  $t^\circ$ . The heights  $H$  and  $h$  are inversely as the densities  $d$  and  $d'$ ; that is,  $\frac{h}{H} = \frac{d'}{d}$ . If we call  $v$  the volume of mercury at zero, its volume at  $t^\circ$  will be  $v + Dv$ ,  $D$  being the coefficient

of absolute expansion of mercury. But these volumes,  $1 + Dt$  and  $1$ , are inversely as the densities  $d$  and  $d'$ ; that is,  $\frac{d}{d'} = \frac{1}{1 + Dt}$ . Consequently

$$\frac{h}{H} = \frac{1}{1 + Dt}, \text{ whence } h = \frac{H}{1 + Dt}. \text{ Replacing } D \text{ by its value } \frac{1}{5508}, \text{ we have}$$

$$h = \frac{H}{1 + \frac{Dt}{5508}} = \frac{5508H}{5508 + t}$$

In this calculation, the coefficient of absolute expansion of mercury is taken, and not that of apparent expansion; for the value  $H$  is the same as if the glass did not expand, the barometric height being independent of the diameter of the tube, and therefore of its expansion.

318. **Force exerted by liquids in expanding.**—The force which liquids exert in expanding is very great, and equal to that which would be required in order to bring the expanded liquid back to its original volume. Now we know what an enormous force is required to compress a liquid to even a very small extent (98). Thus, between  $0^\circ$  and  $10^\circ$ , mercury expands by 0.0017905 of its volume at  $0^\circ$ ; its compressibility is 0.0000295 of its volume for one atmosphere; hence a pressure of more than 600 atmospheres would be requisite to prevent mercury expanding when it is heated from  $0^\circ$  to  $10^\circ$ .

319. **Maximum density of water.**—Water presents the remarkable phenomenon that when its temperature sinks it contracts up to  $4^\circ$ ; but from that point, although the cooling continues, it expands up to the freezing point, so that  $4^\circ$  represent the point of greatest contraction of water.

Many methods have been used to determine the maximum density of water. Hope made the following experiment. He took a deep vessel perforated by two lateral apertures, in which he fixed thermometers, and having filled the vessel with water at  $0^\circ$ , he placed it in a room at a temperature of  $15^\circ$ . As the layers of liquid at the sides of the vessel became heated they sank to the bottom, and the lower thermometer marked  $4^\circ$  while the upper one was still at zero. Hope then made the inverse experiment: having filled the vessel with water at  $15^\circ$ , he placed it in a room at zero. The lower thermometer having sunk to  $4^\circ$  remained stationary for some time, while the upper one cooled down until it reached zero. Both these experiments prove that water is heavier at  $4^\circ$  than at  $0^\circ$ , for in both cases it sinks to the lower part of the vessel.

This last experiment may be adapted for lecture illustration by using a cylinder containing water at  $15^\circ$  C., partially surrounded by a jacket containing bruised ice (fig. 271).

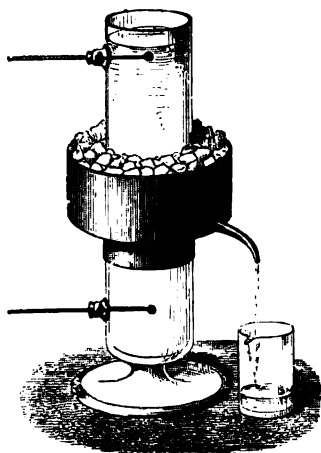

Fig. 271.

Hallström made a determination of the maximum density of water in the

following manner. He took a glass bulb, loaded with sand, and weighed it in water, of different temperatures. Allowing for the expansion of glass, he found that  $4.1^{\circ}$  was the temperature at which it lost most weight, and consequently this was the temperature of the maximum density of water.

Despretz arrived at the temperature  $4^{\circ}$  by another method. He took a water thermometer, that is to say, a bulbed tube containing water, and, placing it in a bath, the temperature of which was indicated by an ordinary mercury thermometer, found that the water contracted to the greatest extent at  $4^{\circ}$ , and that this is therefore the point of greatest density.

This phenomenon is of great importance in the economy of nature. In winter the temperature of lakes and rivers falls from being in contact with the cold air, and from other causes, such as radiation. The colder water sinks to the bottom, and a continual series of currents goes on until the whole has a temperature of  $4^{\circ}$ . The cooling on the surface still continues, but the cooled layers being lighter remain on the surface, and ultimately freeze. The ice formed thus protects the water below, which remains at a temperature of  $4^{\circ}$ , even in the most severe winters, a temperature at which fish and other inhabitants of the water are not destroyed.

The following table of the density of water at various temperatures is based on several sets of observations :—

*Density of water between  $0^{\circ}$  and  $30^{\circ}$ .*

Temperatures.	Densities.	Temperatures.	Densities.	Temperatures.	Densities.
0	0.99988	11	0.99965	22	0.99785
1	0.99993	12	0.99955	23	0.99762
2	0.99997	13	0.99943	24	0.99738
3	0.99999	14	0.99930	25	0.99704
4	1.00000	15	0.99915	26	0.99689
5	0.99999	16	0.99900	27	0.99662
6	0.99997	17	0.99884	28	0.99635
7	0.99994	18	0.99860	29	0.99607
8	0.99988	19	0.99847	30	0.99579
9	0.99982	20	0.99807		
10	0.99974	21	0.99806		

## CHAPTER IV.

### EXPANSION AND DENSITY OF GASES.

320. **Gay-Lussac's method.**—Gases are the most expansible of all bodies, and at the same time the most regular in their expansion. The coefficients of expansion, too, of the several gases differ only by very small quantities. The cubical expansion of gases need alone be considered.

Gay-Lussac first determined the coefficient of the expansion of gases by means of the apparatus represented in fig. 272.

In a rectangular metal bath, about 16 inches long, was fitted an air thermometer, which consisted of a capillary tube, AB, with a bulb, A, at one end. The tube was divided into parts of equal capacity, and the contents of the bulb ascertained in terms of these parts. This was effected by weighing the bulb and tube full of mercury at zero, and then heating slightly to expel a small quantity of mercury, which was weighed. The apparatus being again cooled down to zero, the vacant space in the tube corresponded to the weight of mercury which had overflowed; the volume of mercury

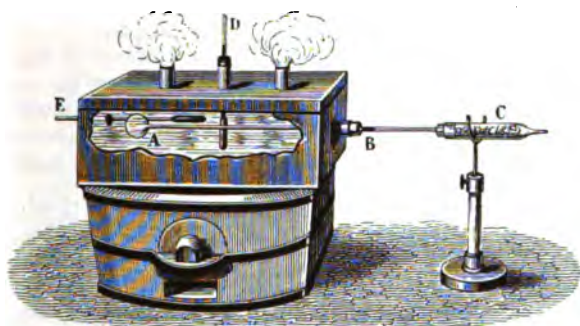

Fig. 272.

remaining in the apparatus, and consequently the volume of the bulb, was determined by calculations analogous to those made for the piezometer (98).

In order to fill the thermometer with dry air it was first filled with mercury, which was boiled in the bulb itself. A tube, C, filled with chloride of calcium, was then fixed on to its end by means of a cork. A fine platinum wire having then been introduced into the stem AB, through the tube C, and the apparatus being slightly inclined and agitated from time to time, air entered, having been previously well dried by passing through the chloride of calcium tube. The whole of the mercury was displaced, with the exception of a small thread, which remained in the tube AB as an index.

The air thermometer was then placed in the box filled with melting ice, the index moved towards A, and the point was noted at which it became stationary. This gave the volume of air at zero; for the capacity of the bulb was known. Water or oil was then substituted for the ice, and the bath successively heated to different temperatures. The air expanded and moved the index from A towards B. The position of the index in each case was noted, and the corresponding temperature was indicated by means of the thermometers D and E.

Assuming that the atmospheric pressure did not vary during the experiment, and neglecting the expansion of the glass as being too small in comparison with that of the air, the total expansion of the air is obtained by subtracting from its volume at a given temperature, its volume at zero. Dividing this by a given temperature, and then by the number of units contained in the volume at zero, the quotient is the coefficient of expansion for a single unit of volume and a single degree: that is, the *coefficient of ex-*

panion. It will be seen, further on, how corrections for pressure and temperature may be introduced.

By this method Gay-Lussac found that the coefficient of expansion of air was 0.00375; and he enunciated the two following laws in reference to the expansion of gases:—

I. *All gases have the same coefficient of expansion as air.*

II. *This coefficient is the same whatever be the pressure supported by the gas.*

These simple laws are not, however, rigorously exact (322); they only express the expansion of gases in an approximate manner.

321. **Problems on the expansion of gases.**—Many of the problems relative to the expansion of gases are similar to those on the expansion of liquids. With obvious modifications, they are solved in a similar manner. In most cases the pressure of the atmosphere must be taken into account in considering the expansion of gases. The following is an example of the manner in which this correction is made:—

i. The volume of a gas at  $t^\circ$ , and under the pressure  $H$ , is  $V'$ ; what will be the volume  $V$  of the same gas at zero, and under the normal pressure 760 millimetres?

Here there are two corrections to be made; one relative to the temperature, and the other to the pressure. It is quite immaterial which is taken first. If  $a$  be the coefficient of cubical expansion for a single degree, by reasoning similar to that in the case of linear expansion (296), the volume of the gas at zero, but still under the pressure  $H$ , will be  $\frac{V'}{1+at}$ . This pressure is reduced to the pressure 760, in accordance with Boyle's law (173), by putting

$$V \times 760 = \frac{V'}{1+at} \times H;$$

whence

$$V = \frac{V'H}{760(1+at)},$$

ii. A volume of gas weighs  $P'$  at  $t^\circ$ ; what will be its weight at zero?

Let  $P'$  be the desired weight,  $a$  the coefficient of expansion of the gas,  $d'$  its density at  $t^\circ$ , and  $d$  its density at zero. As the weights of equal volumes are proportional to the densities, we have  $\frac{P'}{P} = \frac{d'}{d}$ . If  $I$  be the volume of a gas at zero, its volume at  $t$  will be  $I+at$ ; but as the densities are inversely as the volumes  $\frac{d'}{d} = \frac{I}{I+at}$ ,

and therefore

$$\frac{P'}{P} = \frac{I}{I+at};$$

whence

$$P = P'(1+at).$$

From this equation we get  $P' = \frac{P}{1+at}$ , which gives the weight at  $t$ , knowing the weight at zero, and which further shows that the weight  $P'$  is inversely as the binomial of expansion  $I+at$ .

322. **Regnault's method.**—M. Regnault used successively four different methods for determining the expansion of gases. In some of them the pressure was constant and the volume variable, as in Gay-Lussac's method ; in others the volume remained the same while the pressure varied. The first method will be described. It is the same as that used by Rudberg and Dulong, but is distinguished by the care with which all sources of error are avoided.

The apparatus consisted of a pretty large cylindrical reservoir, B (fig. 273), terminating in a bent capillary tube. In order to fill the reservoir with

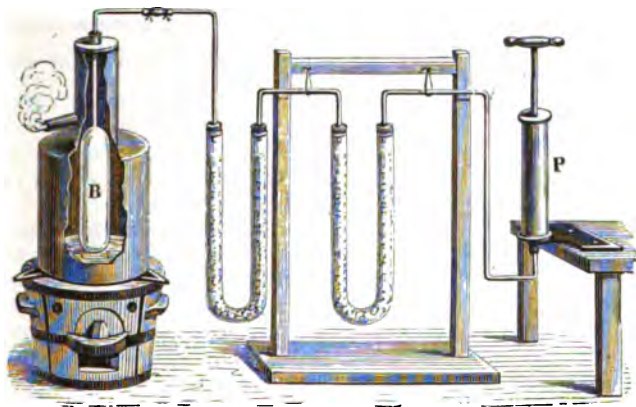

Fig. 273.

dry air, it was placed in a hot water bath, and the capillary tube connected by a caoutchouc tube with a series of drying tubes. These tubes were joined to a small air-pump, P, by which a vacuum could be produced in the reservoir while at a temperature of  $100^{\circ}$ . The reservoir was first exhausted, and air afterwards admitted slowly ; this operation was repeated a great many times, so that the air in the reservoir became quite dry, for the moisture adhering to the sides passed off in vapour at  $100^{\circ}$ , and the air which entered became dry in its passage through the U tubes.

The reservoir was then kept for half an hour at the temperature of boiling water ; the air-pump having been detached, the drying tubes were then disconnected, and the end of the tube hermetically sealed, the height, H, of the barometer being noted. When the reservoir B was cool, it was placed in the apparatus represented in fig. 274. It was there quite surrounded with ice, and the end of the tube dipped in the mercury bath, C. After the air in the reservoir B had sunk to zero, the point *b* was broken off by means of a forceps ; the air in the interior became condensed by atmospheric pressure, the mercury rising to a height *oG*. In order to measure the height of this column, *Go*, which will be called *h*, a movable rod, *go*, was lowered until its point, *o*, was flush with the surface of the mercury in the bath ; the distance between the point *o* and the level of the mercury *G* was measured by means of the cathetometer. The point *b* was finally closed



with wax by means of the spoon *a*, and the barometric pressure noted at this moment. If this pressure be *H'*, the pressure in the reservoir is *H' - h*.

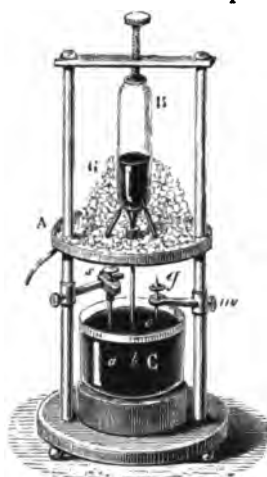

Fig. 274.

The reservoir was now weighed to ascertain *P*, the weight of the mercury which it contained. It was then completely filled with mercury at zero, in order to have the weight *P'* of the mercury in the reservoir and in the tube.

If  $\delta$  be the coefficient of the cubical expansion of glass, and *D* the density of mercury at zero, the coefficient *a* of the cubical expansion of air is determined in the following manner. The volume of the reservoir and of the tube at zero is  $\frac{P'}{D}$  from the formula  $P = VD$  (126); consequently this volume is

$$\frac{P'}{D} (1 + \delta t) \dots \dots \dots (1)$$

at the temperature  $t^\circ$ , assuming, as is the case, that the reservoir and tube expand as if they were solid glass. But from the formula  $P = VD$ , the volume of air in the reservoir at zero,

and under the pressure  $H - h$ , is  $\frac{P' - P}{D}$ . At the same pressure, but at  $t^\circ$ , its volume would be

$$\frac{P' - P}{D} (1 + at)$$

and by Boyle's law (173), at the pressure *H*, at which the tube was sealed, this volume must have been

$$\frac{(P' - P)(1 + at)(H' - h)}{DH} \dots \dots \dots (2)$$

Now the volumes represented by these formulæ, (1) and (2), are each equal to the volume of the reservoir and the tube at  $t^\circ$ ; they are therefore equal. Removing the denominators, we have

$$P' (1 + \delta t) H = (P' - P) (1 + at) (H' - h) \dots \dots \dots (3)$$

from which the value of *a* is deduced.

The means of a great number of experiments between zero and  $100^\circ$  and for pressures between 300 millimetres and 500 millimetres, gave the following numbers for the coefficients of expansion for a single degree :

Air . . . . .	0.003667	Carbonic acid . . . . .	0.003710
Hydrogen . . . . .	0.003661	Nitrous oxide . . . . .	0.003719
Nitrogen . . . . .	0.003661	Cyanogen . . . . .	0.003877
Carbonic oxide . . . . .	0.003667	Sulphurous acid . . . . .	0.003903

These numbers, with which the results obtained by Magnus closely agree, show that the coefficients of expansion of the permanent gases differ very little ; but that they are somewhat greater in the case of the condensible

gases, such as carbonic and sulphurous acids. Regnault has further found that, at the same temperature, the coefficient of expansion of any gas increases with the pressure which it supports. Thus, while the coefficient of expansion of air under a pressure of 110<sup>mm</sup> is 0.003648, under a pressure of 365<sup>mm</sup>, or nearly five atmospheres, it is 0.003709.

The number found by Regnault for the coefficient of the expansion of air, 0.003667, is equal to  $\frac{1}{271.9} = \frac{1}{272}$  nearly; and if we take the coefficient of expansion at 0.003666 . . . it may be represented by the fraction  $\frac{11}{3000}$ , which is convenient for purposes of calculation.

323. **Air thermometer.**—The *air thermometer* is based on the expansion of air. When it is used to measure small differences of temperature, it has the same form as the tube used by Gay-Lussac in determining the expansion of air (fig. 272), that is, a capillary tube with a bulb at the end. The reservoir being filled with dry air, an index of coloured sulphuric acid is passed into the tube; the apparatus is then graduated in Centigrade degrees by comparing the positions of the index with the indications of a mercurial thermometer. Of course the end of the tube must remain open; otherwise, the air above the index condensing or expanding at the same time as that in the bulb, the index would remain stationary. A correction must be made at each observation for the atmospheric pressure.

When considerable variations of temperature are to be measured, the tube has a form like that used in Regnault's experiments (figs. 273 and 274). By experiments made as described in article 322, P, P', H, H', and h, may be found, and the coefficients  $a$  and  $\delta$  being known, the temperature  $t$  to which the tube has been raised is readily deduced from the equation (3).

Regnault's researches show that the air and the mercurial thermometer agree up to 260°, but above that point mercury expands relatively more than air.

In cases where very high temperatures are to be measured the reservoir is made of platinum. The use of an air thermometer is seen in Dulong and Petit's experiment (312); it was by such an apparatus that Pouillet measured the temperature corresponding to the colours which metals take when heated in a fire, and found them to be as follows:—

Incipient red . . . . .	525°C.	Dark orange . . . . .	1100°C.
Dull red . . . . .	700	White . . . . .	1300
Cherry red . . . . .	900	Dazzling white . . . . .	1500

In the measurement of high temperatures Deville and Troost have used with advantage the vapour of iodine instead of air, and as platinum has been found to be permeable to gases at high temperature, they have employed porcelain instead of that metal.

324. **Density of gases.**—The relative *density* of a gas, or its *specific gravity*, is the ratio of the weight of a certain volume of the gas to that of the same volume of air; both the gas and the air being at zero and at a pressure of 760 millimetres.

In order, therefore, to find the specific gravity of a gas, it is necessary to determine the weight of a certain volume of this gas at a pressure of 760 millimetres, and a temperature of zero, and then the weight of the same volume of air under the same conditions. For this purpose a large globe of

about two gallons' capacity is used, the neck of which is provided with a stopcock, which can be screwed to the air-pump. The globe is first weighed empty, and then full of air, and afterwards full of the gas in question. The weights of the gas and of the air are obtained by subtracting the weight of the exhausted globe from the weight of the globes filled, respectively, with air and gas. The quotient, obtained by dividing the latter by the former, gives the specific gravity of the gas. It is difficult to make these determinations at the same temperature and pressure, and therefore all the weights are reduced to zero and the normal pressure of 760 millimetres.

The gases are dried by causing them to pass through drying tubes before they enter the globe, and air must also be passed over potash to free it from carbonic acid. And as even the best air-pumps never produce a perfect vacuum, it is necessary to exhaust the globe until the manometer in each case marks the same pressure.

The globe having been exhausted, dried air is allowed to enter, and the process is repeated several times until the globe is perfectly dried. It is then finally exhausted until the residual tension, in millimetres, is  $e$ . The weight of the exhausted globe is  $\phi$ . Air, which has been dried and purified by passing through potash and chloride of calcium tubes, is then allowed to enter slowly. The weight of the globe full of air is  $P$ . If  $H$  is the barometric height in millimetres, and  $t^\circ$  the temperature at the time of weighing,  $P - \phi$  is the weight of the globe full of air at the temperature  $t$ , and the pressure  $H - e$ .

To reduce this weight to the pressure 760 millimetres and the temperature zero, let  $a$  be the coefficient of the expansion of air, and  $\delta$  the coefficient of the cubical expansion of glass. From Boyle's law the weight, which is  $P - \phi$  at  $t^\circ$ , and a pressure of  $H - e$  would be  $\frac{(P - \phi) 760}{H - e}$  under the pressure 760 millimetres and at the same temperature  $t^\circ$ . If the temperature is  $0^\circ$ , the capacity of the globe will diminish in the ratio  $1 + \delta t$  to 1, while the weight of the gas increases in the ratio  $1 : 1 + at$ , as follows from the problems in art. 309. Consequently, the weight of the air in the globe at  $0^\circ$  and at the pressure 760 millimetres will be

$$(P - \phi) \cdot \frac{760 (1 + at)}{(H - e) (1 + \delta t)} \dots \dots \dots (1)$$

Further, let  $a'$  be the coefficient of expansion of the gas in question; let  $P'$  be the weight of the globe full of gas at the temperature  $t'$  and the pressure  $H'$ , and let  $\phi'$  be the weight of the globe when it is exhausted to the pressure  $e$ ; the weight of the gas in the globe at the pressure 760 and the temperature zero will be

$$(P' - \phi') \cdot \frac{760 (1 + a't')}{(H' - e) (1 + \delta t')} \dots \dots \dots (2)$$

Dividing the latter formula by the former we obtain the density

$$D = \frac{(P' - \phi') (H - e) (1 + at') (1 + \delta t)}{(P - \phi) (H' - e) (1 + at) (1 + \delta t')}$$

If the temperature and the pressure do not vary during the experiment,  $H = H'$  and  $t = t'$ ; whence  $D = \frac{(P - \phi') (1 + a't)}{(P - \phi) (1 + at)}$ , and if  $a = a'$ ,  $D = \frac{P' - \phi'}{P - \phi}$ .

325. **Regnault's method of determining the density of gases.**—M. Regnault has so modified the above method that many of the corrections may be dispensed with. The globe in which the gas is weighed is suspended from one pan of a balance, and is counterpoised by means of a second globe of the same dimensions, and hermetically sealed, suspended from the other. These two globes expanding at the same time always displace the same quantity of air, and consequently variations in the temperature and pressure of the atmosphere do not influence the weighing. The globe, too, is filled with the air or with the gas, at the temperature of zero. This is effected by placing it in a vessel full of ice, as shown in fig. 275. It is then connected

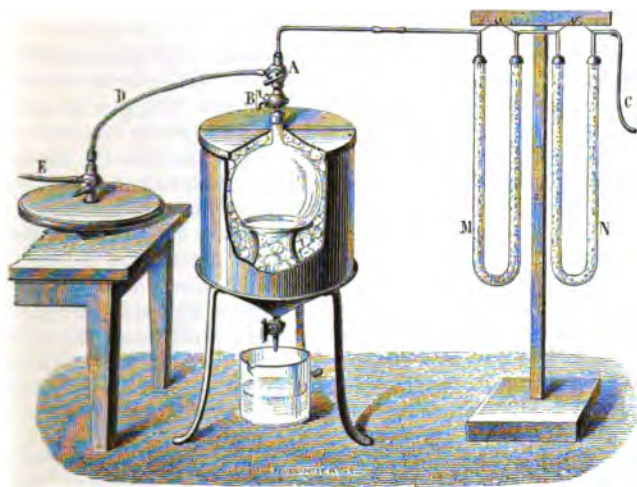

Fig. 275.

with a three-way cock, A, by which it may be connected either with an air-pump, or with the tubes M and N, which are connected with the reservoir of gas. The tubes M and N contain substances which by their action on the gas dry and also purify it.

The stopcock A being so turned that the globe is only connected with the air-pump, a vacuum is produced; by means of the same cock, the connection with the pump being cut off, but established between M and N, the gas soon fills the globe. But as the exhaustion could not have been complete, and some air must have been left, the globe is again exhausted and the gas allowed to enter, and the process is repeated until it is thought all air is removed. The globe being once more produced, a differential barometer (fig. 132), connected with the apparatus by the tube E, indicates the pressure of the residual rarefied gas *e*. Closing the cock B and detaching A, the globe is removed from the ice, and after being cleaned is weighed.

This gives the weight of the empty globe  $\rho$ ; it is again replaced in the ice, the stopcock A adjusted, and the gas allowed to enter, care being taken to leave the stopcocks open long enough to allow the gas in the globe to

acquire the pressure of the atmosphere,  $H$ , which is marked by the barometer. The stopcock  $B$  is then closed,  $A$  removed, and the globe weighed with the same precautions as before. This gives the weight  $P_1$  of the gas.

The same operations are then repeated on this globe with air, and two corresponding weights  $\rho$  and  $P$  are obtained. The only correction necessary is to reduce the weights in the two cases to the standard pressure by the method described in the preceding paragraph. The correction for temperature is not needed, as the gas is at the temperature of melting ice. The ratio of the weight of the gas to that of the air is thus obtained by the formula

$$D = \frac{P' - \rho'}{P - \rho}$$

326. **Density of gases which attack metals.**—For gases which attack the ordinary metals, such as chlorine, a metal stopcock cannot be used, and vessels with ground glass stoppers are substituted. The gas is introduced by a bent glass tube, the vessel being held either upright or inverted, according as the gas is heavier or lighter than air; when the vessel is supposed to be full, the tube is withdrawn, the stopper inserted, and the weight taken. This gives the weight of the vessel and gas. If the capacity of the vessel be measured by means of water, the weight of the air which it contains is deduced, for the density of air at  $0^\circ$  C. and 760 millimetres pressure is  $\frac{1}{773}$  that of distilled water under the same circumstances. The weight of the vessel full of air, less the weight of the contained air, gives the weight of the vessel itself. From these three data—the weight of the vessel full of the gas, the weight of the air which it contains, and the weight of the vessel alone—the specific gravity of the gas is readily deduced, the necessary corrections being made for temperature and pressure.

*Density of gases at zero and at a pressure of 760 millimetres, that of air being taken as unity.*

Air . . . . .	1·0000	Sulphuretted hydrogen . . . . .	1·1912
Hydrogen . . . . .	0·0693	Hydrochloric acid . . . . .	1·2540
Ammoniacal gas . . . . .	0·5367	Protoxide of nitrogen . . . . .	1·5270
Marsh gas . . . . .	0·5590	Carbonic acid . . . . .	1·5291
Carbonic oxide . . . . .	0·9670	Cyanogen . . . . .	1·8600
Nitrogen . . . . .	0·9714	Sulphurous acid . . . . .	2·2474
Binoxide of nitrogen . . . . .	1·0360	Chlorine . . . . .	3·4400
Oxygen . . . . .	1·1057	Hydriodic acid . . . . .	4·4430

Regnault has furnished the following determinations of the weight of a litre of the most important gases at  $0^\circ$  C. and 760 mm. :—

Air . . . . .	1·293187 grms.	Nitrogen . . . . .	1·256167 grms.
Oxygen . . . . .	1·429802	Carbonic acid . . . . .	1·977414
Hydrogen . . . . .	0·089578		

## CHAPTER V.

## CHANGES OF CONDITION. VAPOURS.

327. **Fusion. Its laws.**—The only phenomena of heat with which we have hitherto been engaged have been those of expansion. In the case of solids it is easy to see that this expansion is limited. For in proportion as a body absorbs a larger quantity of heat, the repulsive force between the molecules is increased, and ultimately a point is reached at which the molecular attraction is not sufficient to retain the body in the solid state. A new phenomenon is then produced: *fusion* takes place; that is, the body passes from the solid into the liquid state.

Some substances, however, such as paper, wood, wool, and certain salts, do not fuse at a high temperature, but are decomposed. Many bodies have long been considered *refractory*; that is, incapable of fusion; but, in proportion as it has been possible to produce higher temperatures, their number has diminished. Gaudin has succeeded in fusing rock crystal by means of a lamp fed by a jet of oxygen; and more recently Despretz, by combining the effects of the sun, the voltaic battery, and the oxy-hydrogen blow-pipe, has melted alumina and magnesia, and softened carbon so as to be flexible, which is a condition near that of fusion.

It has been found experimentally that the fusion of bodies is governed by the two following laws:—

I. *Every substance begins to fuse at a certain temperature, which is invariable for each substance if the pressure be constant.*

II. *Whatever be the intensity of the source of heat, from the moment fusion begins, the temperature of the body ceases to rise, and remains constant until the fusion is complete.*

*Fusing points of certain substances.*

Mercury . . . . .	- 38° 8'	Sodium . . . . .	90
Bromine . . . . .	- 12° 5'	Rose's fusible metal . . . . .	94
Ice . . . . .	0	Sulphur . . . . .	114
Butter . . . . .	+ 33	Tin . . . . .	228
Phosphorus . . . . .	44	Bismuth . . . . .	264
Spermaceti . . . . .	49	Cadmium . . . . .	321
Potassium . . . . .	55	Lead . . . . .	335
Margaric acid . . . . .	57	Zinc . . . . .	422
Stearine . . . . .	60	Antimony . . . . .	450
White wax . . . . .	65	Silver . . . . .	1000
Wood's fusible metal . . . . .	68	Gold . . . . .	1250
Stearic acid . . . . .	70	Iron . . . . .	1500

Some substances pass from the solid to the liquid state without showing any definite melting point; for example, glass and iron become gradually softer and softer when heated, and pass by imperceptible stages from the

solid to the liquid condition. This intermediate condition is spoken of as the state of *vitreous fusion*. Such substances may be said to melt at the lowest temperature at which perceptible softening occurs, and to be fully melted when the further elevation of temperature does not make them more fluid; but no precise temperature can be given as their melting points.

328. **Influence of pressure on the melting point.**—Thomson and Clausius have deduced from the principles of the mechanical theory of heat that, with an increase of pressure, the melting point of a body must be raised. All bodies which expand on passing from the solid to the liquid state have to perform external work—namely, to raise the pressure of the atmosphere by the amount of this expansion. Under ordinary circumstances, the amount of external work which solids and liquids thus perform is so small that it may be neglected. But if the external pressure be increased, the power of overcoming it can only be obtained by an increase of vis viva of the molecules. This increase can do more work; the temperature of fusion as well as the heat of fusion are both increased. Thus Bunsen found that spermaceti, which melts at  $48^{\circ}$  under a pressure of 1 atmosphere, melts at  $51^{\circ}$  under a pressure of 156 atmospheres. Hopkins found that spermaceti melted at  $60^{\circ}$  under a pressure of 519 atmospheres, and at  $80^{\circ}$  under 792 atmospheres; the melting point of sulphur under these pressures was respectively  $135^{\circ}$  and  $141^{\circ}$ .

But in the case of those bodies which contract on passing from the solid to the liquid state, and of which water is the best example, the reverse is the case. Melting ice has no external work to perform, since it has no external pressure to raise; on the contrary, in melting, it assimilates external work which, transformed into heat, renders a smaller quantity of heat necessary; the external work acts in the same direction as the internal heat—namely, in breaking up the crystalline aggregates. Yet these differences of temperature must be but small, for the molecular forces in solids preponderate far over the external pressure; the internal work is far greater than the external.

Sir W. Thomson found that pressures of 8.1 and 16.8 atmospheres lowered the melting point of ice by  $0.059^{\circ}$  and  $0.126^{\circ}$  respectively. These results justify the theoretical previsions of Prof. J. Thomson, according to which an increase of pressure of  $n$  atmospheres lowers the melting point of ice by  $0.0074n^{\circ}$  C.

329. **Alloys. Fluxes.**—Alloys are generally more fusible than any of the metals of which they are composed; for instance, an alloy of five parts of tin and one of lead fuses at  $194^{\circ}$ . The alloy known as *Rose's fusible metal*, which consists of 4 parts of bismuth, 1 part of lead, and 1 of tin, melts at  $94^{\circ}$ , and an alloy of 1 or 2 parts of cadmium with 2 parts of tin, 4 parts of lead, and 7 or 8 parts of bismuth, known as *Wood's fusible metal*, melts between  $66^{\circ}$  and  $71^{\circ}$  C. Fusible alloys are of extended use in soldering and in taking casts. Steel melts at a lower temperature than iron, though it contains carbon, which is almost completely infusible.

Mixtures of the fatty acids melt at lower temperatures than the pure acids. A mixture of the chlorides of potassium and of sodium fuses at a lower temperature than either of its constituents; the same is the case with a mixture

of the carbonates of potassium and sodium, especially when they are mixed in the proportion of their chemical equivalents.

An application of this property is met with in the case of *fluxes*, which are much used in metallurgical operations. They consist of substances which, when added to an ore, partly by their chemical action, help the reduction of the substance to the metallic state, and, partly, by presenting a readily fusible medium, promote the formation of a regulus.

330. **Latent heat.**—Since during the passage of a body from the solid to the liquid state, the temperature remains constant until the fusion is complete, whatever be the intensity of the source of heat, it must be concluded that, in changing their condition, bodies absorb a considerable amount of heat, the only effect of which is to maintain them in the liquid state. This heat, which is not indicated by the thermometer, is called *latent heat* or *latent heat of fusion*, an expression which, though not in strict accordance with modern ideas, is convenient from the fact of its universal recognition and employment (448).

An idea of what is meant by latent heat may be obtained from the following experiment. If a pound of water at  $80^{\circ}$  is mixed with a pound of water at zero, the temperature of the mixture is  $40^{\circ}$ . But if a pound of pounded *ice* at zero is mixed with a pound of water at  $80^{\circ}$ , the ice melts, and two pounds of water at zero are obtained. Consequently, the mere change of a pound of ice to a pound of water at the same temperature requires as much heat as will raise a pound of water through  $80^{\circ}$ . This quantity of heat represents the latent heat of the fusion of ice, or the latent heat of water.

Every liquid has its own latent heat, and in the chapter on Calorimetry we shall show how this is determined.

331. **Solution.**—A body is said to *dissolve* when it becomes liquid in consequence of an affinity between its molecules and those of a liquid. Gum arabic, sugar, and most salts dissolve in water.

During solution, as well as during fusion, a certain quantity of heat always becomes latent, and hence it is that the solution of a substance usually produces a diminution of temperature. In certain cases, however, instead of the temperature being lowered, it actually rises, as when caustic potass is dissolved in water. This depends upon the fact that two simultaneous and contrary phenomena are produced. The first is the passage from the solid to the liquid condition, which always lowers the temperature. The second is the *chemical* combination of the body dissolved with the liquid, and which, as in the case of all chemical combinations, produces an increase of temperature. Consequently, as the one or the other of these effects predominates, or as they are equal, the temperature either rises or sinks, or remains constant.

332. **Solidification.**—*Solidification* or *congelation* is the passage of a body from the liquid to the solid state. This phenomenon is regulated by the two following laws:—

I. *Every body, under the same pressure, solidifies at a fixed temperature, which is the same as that of fusion.*

II. *From the commencement to the end of the solidification, the temperature of a liquid remains constant.*



Certain bodies, more especially some of the fats, present an exception to the first law, in so far that by repeated fusions they seem to undergo a molecular change which alters their melting point.

The second law is the consequence of the fact that the latent heat absorbed during fusion becomes free at the moment of solidification.

Many liquids, such as alcohol, ether, and bisulphide of carbon, do not solidify even at the lowest known temperature. Despretz, by the cold produced by a mixture of liquid protoxide of nitrogen, solid carbonic acid, and ether, reduced alcohol to such a consistence that the vessel containing it could be inverted without losing the liquid.

**333. Crystallisation.**—Generally speaking, bodies which pass slowly from the liquid to the solid state assume regular geometrical forms, such as the cube, prisms, rhombohedra, &c. ; these are called *crystals*. If the crystals are formed from a body in fusion, such as sulphur or bismuth, the crystallisation is said to take place by the *dry way*. But if the crystallisation takes place owing to the slow evaporation of a solution of a salt, it is said to be by the *moist way*. Snow, ice, and many salts present examples of crystallisation.

**334. Retardation of the point of solidification.**—The freezing point of pure water can be diminished by several degrees, if the water be previously freed from air by boiling and be then kept in a perfectly still place. In fact, it may be cooled to  $-15^{\circ}$  C., and even lower, without freezing. But when it is slightly agitated, the liquid at once solidifies. The smaller the quantity of liquid the lower the temperature to which it can be cooled, and the greater the mechanical disturbance it supports without freezing. Fournet has observed the frequent occurrence of mists formed of particles of liquid matter suspended in an atmosphere whose temperature was  $10^{\circ}$  or even  $15^{\circ}$  below zero.

A very rapid agitation also prevents the formation of ice. The same is the case with all actions which, hindering the molecules in their movements, do not permit them to arrange themselves in the conditions necessary for the solid state. Despretz was able to lower the temperature of water contained in fine capillary tubes to  $-20^{\circ}$  without their solidifying. This experiment shows how it is that plants in many cases do not become frozen, even during severe cold, as the sap is contained in very fine capillary vessels. Finally, M. Mousson has found that a powerful pressure not only retards the freezing of water, but prevents its complete solidification. In this case the pressure opposes the tendency of the water to expand on freezing and thus virtually lowers the point of solidification.

If water contains salts, or other foreign bodies, its freezing point is lowered. Sea water freezes at  $-2.5^{\circ}$  to  $-3^{\circ}$  C. ; the ice which forms is quite pure, and a saturated solution remains. In Finland, advantage is taken of this property to concentrate sea water for the purpose of extracting salt from it. If water contains alcohol, precisely analogous phenomena are observed ; the ice formed is pure, and practically all the alcohol is contained in the residue.

Dufour has observed some very curious cases of liquids cooled out of contact with solid bodies. His mode of experimenting was to place the liquid in another of the same specific gravity but of lower melting point,

and in which it is insoluble. Spheres of water, for instance, suspended in a mixture of chloroform and oil, usually solidified between  $-4^{\circ}$  and  $-12^{\circ}$ , while some smaller globules cooled down to  $-18^{\circ}$  or  $-20^{\circ}$ . Contact with a fragment of ice immediately set up congelation. Globules of sulphur (which solidifies at  $115^{\circ}$ ) remained liquid at  $40^{\circ}$ ; and globules of phosphorus (solidifying point  $42^{\circ}$ ) at  $20^{\circ}$ .

When a liquid solidifies after being cooled below its normal freezing point, the solidification takes place very rapidly, and is accompanied by a disengagement of heat, which is sufficient to raise its temperature from the point at which solidification begins up to its ordinary freezing point. This is well seen in the case of hyposulphite of sodium, which melts in its own water of crystallisation at  $45^{\circ}$ , and when carefully cooled will remain liquid at the ordinary temperature of the atmosphere. If it then be made to solidify by agitation, or by adding a small fragment of the solid salt, the rise of temperature is distinctly felt by the hand. In this case the heat which had become latent in the process of liquefaction again becomes free, and a portion of the substance remains melted; for it is kept liquid by the heat of solidification of that which has solidified.

**335. Change of volume on solidification and liquefaction.**—The rate of expansion of bodies generally increases as they approach their melting points, and is in most cases followed by a further expansion at the moment of liquefaction, so that the liquid occupies a greater volume than the solid from which it is formed. Phosphorus, for instance, increases about 3·4 per cent. on liquefaction; that is, 100 volumes of solid phosphorus at  $44^{\circ}$  (the melting point) become 103·4 at the same temperature when melted. Sulphur expands about 5 per cent. on liquefying, and stearic acid about 11 per cent.

Water presents a remarkable exception; it expands on the moment of solidifying, or contracts on melting, by about ten per cent. One volume of ice at  $0^{\circ}$  gives 0·9178 of water at  $0^{\circ}$ , or 1 volume of water at  $0^{\circ}$  gives 1·102 of ice at the same temperature. In consequence of this expansion, ice floats on the surface of water. According to Dufour, the specific gravity of ice is 0·9178; Bunsen found for ice which had been freed from water by boiling the somewhat smaller number 0·91674.

The increase of volume in the formation of ice is accompanied by an expansive force which sometimes produces powerful mechanical effects, of which the bursting of water-pipes and the breaking of jugs containing water are familiar examples. The splitting of stones, rocks, and the swelling up of moist ground during frost, are caused by the fact that water penetrates into the pores and there becomes frozen; in short, the great expansion of water on freezing is the most active and powerful agent of disintegration on the earth's surface.

The expansive force of ice was strikingly shown by some experiments of Major Williams, in Canada. Having quite filled a 13-inch iron bomb-shell with water, he firmly closed the touch-hole with an iron plug weighing three pounds, and exposed it in this state to the frost. After some time the iron plug was forced out with a loud explosion, and thrown to a distance of 415 feet, and a cylinder of ice 8 inches long issued from the opening. In another case the shell burst before the plug was driven out, and in this case

a sheet of ice spread out all round the crack. It is possible that under the great pressure some of the water still remained liquid up to the time at which the resistance was overcome; that it then issued from the shell in a liquid state, but at a temperature below  $0^{\circ}$ , and therefore instantly began to solidify when the pressure was removed, and thus retained the shape of the orifice whence it issued.

Cast-iron, bismuth, and antimony expand on solidifying like water, and can thus be used for casting; but gold, silver, and copper contract, and hence coins of these metals cannot be cast, but must be stamped with a die.

**336. Freezing mixtures.**—The absorption of heat in the passage of bodies from the solid to the liquid state has been used to produce artificial cold. This is effected by mixing together bodies which have an affinity for each other, and of which one at least is solid, such as water and a salt, ice and a salt, or an acid and a salt. Chemical affinity accelerates the fusion: the portion which melts robs the rest of the mixture of a large quantity of sensible heat, which thus becomes latent. In many cases a very considerable diminution of temperature is produced.

The following table gives the names of the substances mixed, their proportions, and the corresponding diminutions of temperature:—

Substances	Parts by weight.	Reduction of temperature.
Sulphate of sodium . . . . .	8	. . . + $10^{\circ}$ to $-17^{\circ}$
Hydrochloric acid . . . . .	5	
Pounded ice or snow . . . . .	2	. . . + $10^{\circ}$ to $-18^{\circ}$
Common salt . . . . .	1	
Sulphate of sodium . . . . .	3	. . . + $10^{\circ}$ to $-19^{\circ}$
Dilute nitric acid . . . . .	2	
Sulphate of sodium . . . . .	6	. . . + $10^{\circ}$ to $-26^{\circ}$
Nitrate of ammonium . . . . .	5	
Dilute nitric acid . . . . .	4	
Phosphate of sodium . . . . .	9	. . . + $10^{\circ}$ to $-29^{\circ}$
Dilute nitric acid . . . . .	4	

If the substances taken be themselves first previously cooled down, a still more considerable diminution of temperature is occasioned.

Freezing mixtures are frequently used in chemistry, in physics, and in domestic economy. One form of the portable ice-making machines which have come into use during the last few years consists of a cylindrical metallic vessel divided into four concentric compartments. In the central one is placed the water to be frozen; in the next there is the freezing mixture, which usually consists of sulphate of sodium and hydrochloric acid; 6 pounds of the former and 5 of the latter will make 5 to 6 pounds of ice in an hour. The third compartment also contains water, and the outside one contains some badly-conducting substance, such as cotton, to cut off the influence of the external temperature. The best effect is obtained when pretty large quantities (2 or 3 pounds) of the mixture are used, and when they are intimately mixed. It is also advantageous to use the machines for a series of successive operations.

**337. Guthrie's researches.**—It appears from recent experiments of Guthrie that what are called freezing mixtures may be divided into two

classes, namely those in which one of the constituents is liquid and those in which both are solid. The temperature indicated by the thermometer placed in a freezing mixture is, of course, due to the loss of heat by the thermometer to the liquefying freezing mixture, and is measured by the rate of such loss. The quantity of heat absorbed by the freezing mixture is obviously the heat required to melt the constituents together with ( $\pm$ ) the heat of combination of the constituents. When one constituent is liquid, as when hydrochloric acid is added to ice, then a lower temperature is got by previously cooling the hydrochloric acid. There is no advantage in cooling the ice. But when both constituents are solid, as in the case of the ice salt freezing mixture, there is no advantage to be gained by cooling one or both constituents. Within very wide limits it is also in the latter cases a matter of indifference as to the ratio between the constituents. Nor does it matter whether the ice be finely powdered as snow or in pieces as large as a pea.

The different powers of various salts when used in conjunction with ice as freezing mixtures appear to have remained unexplained until Guthrie showed that, with each salt, there is always a minimum temperature below which it is impossible for an aqueous solution of any strength of that salt to exist in the liquid form; that there is a certain strength of solution for each salt which resists solidification the longest, that is, to the lowest temperature. Weaker solutions give up ice on being cooled, stronger solutions give up the salt either in the anhydrous state or in combination with water. That particular strength of a particular salt which resists solidification to the lowest temperature is called by Guthrie a *cryohydrate*. It is of such a strength that when cooled below  $0^{\circ}$  C. it solidifies as a whole, that is the ice and the salt solidify together and form crystals of constant composition and constant melting and the same solidifying temperatures. The liquid portion of a freezing mixture, as long as the temperature is at its lowest, is, indeed, a melted cryohydrate. The slightest depression of temperature below this causes solidification of the cryohydrate, and hence the temperature can never sink below the solidifying temperature of the cryohydrate.

Guthrie has also shown that colloid bodies, such as gum and gelatine, neither raise the boiling point of water, nor depress the solidifying point, nor can they act as elements in freezing mixtures.

#### VAPOURS. MEASUREMENT OF THEIR TENSION.

338. **Vapours.**—We have already seen (146) that *vapours* are the æri-form fluids into which volatile substances, such as ether, alcohol, water, and mercury, are changed by the absorption of heat. *Volatile liquids* are those which thus possess the property of passing into the æri-form state, and *fixed liquids* those which do not form vapours at any temperature without undergoing chemical decomposition, such as the fatty oils. There are some solids, such as arsenic, camphor, and in general all odoriferous solid substances, which can directly form vapours without first becoming liquid.

Vapours are transparent like gases, and generally colourless; there are only a few coloured liquids which also give coloured vapours.

339. **Vaporisation.**—The passage of a liquid into the gaseous state is designated by the general term *vaporisation*; the term *evaporation* esp-

cially refers to the slow production of vapour at the free surface of a liquid, and *boiling* to its rapid production in the mass of the liquid itself. We shall presently see (352) that at the ordinary atmospheric pressure, ebullition, like fusion, takes place at a definite temperature. This is not the case with evaporation, which takes place even with the same liquid at very different temperatures, although the formation of a vapour seems to cease below a certain point. Mercury, for example, gives no vapour below  $-10^{\circ}$ , nor sulphuric acid below  $30^{\circ}$ .

**340. Elastic force of vapours.**—Like gases, vapours have a certain elastic force, in virtue of which they exert pressures on the sides of vessels in which they are contained. The tension of vapours may be demonstrated by the following experiment:—A quantity of mercury is placed in a bent glass tube (fig. 276), the shorter leg of which is closed; a few drops of ether are then passed into the closed leg, and the tube immersed in a water bath at a temperature of about  $45^{\circ}$ . The mercury then sinks slowly in the short branch, and the space *ab* is filled with a gas which has all the appearance of air, and whose elastic force counterbalances the pressure of the column of mercury *cd*, and the atmospheric pressure on *d*. This gas is the vapour of ether. If the water be cooled, or if the tube be removed from the bath, the vapour which fills the space *ab* disappears, and the drop of ether is reproduced. If, on the contrary, the bath be heated still higher, the level of the mercury descends below *b*, indicating an increased tension.



Fig. 276.

**341. Formation of vapours in a vacuum.**—In the previous experiment the liquid changed very slowly into the vaporous condition; the same is the case when a liquid is freely exposed to the air. In both cases the atmosphere is an obstacle to the vaporisation. In a vacuum there is no resistance, and the formation of vapours is instantaneous, as is seen in the following experiment:—Four barometer tubes, filled with mercury, are immersed in the same trough, fig. 277. One of them, A, serves as a barometer, and a few drops of water, alcohol, and ether are respectively introduced into the tubes, B, C, D. When the liquids reach the vacuum, a depression of the mercury is at once produced. And as this depression cannot be produced by the weight of the liquid, which is an infinitely small fraction of the weight of the displaced mercury, it must be due to the formation of some vapour whose elastic force has depressed the mercurial column.

The experiment also shows that the depression is not the same in all the tubes; it is greater in the case of alcohol than of water, and greater with ether than with alcohol. We consequently obtain the two following laws for the formation of vapours:—

1. *In a vacuum all volatile liquids are instantaneously converted into vapour.*

II. *At the same temperature the vapours of different liquids have different elastic forces.*

For example, at  $20^{\circ}$  the tension of ether vapour is 25 times as great as that of aqueous vapour.

**342. Saturated vapours. Maximum of tension.**—When a very small quantity of a volatile liquid, such as ether, is introduced into a barometer tube, it is at once completely vaporised, and the mercurial column is not depressed to its full extent; for if some more ether be introduced the depression increases. By continuing the addition of ether, it finally ceases to vaporise, and remains in the liquid state. There is, therefore, for a certain temperature, a limit to the quantity of vapour which can be formed in a given space. This space is accordingly said to be *saturated*. Further, when the vaporisation of the ether ceases, the depression of the mercurial column stops. And hence there is a limit to the tension of the vapour, a limit which, as we shall presently see (345), varies with the temperature, but which for a given temperature is *independent of the pressure*.

To show that, in a closed space, saturated with vapour and containing liquid *in excess*, the temperature remaining constant, there is a *maximum of tension* which the vapour cannot exceed, a barometric tube is used which dips in a deep bath (fig. 278). This tube is filled with mercury, and then so much ether is added as to be in excess after the Torricellian vacuum is saturated. The height of the mercurial column is next noted by means of the scale graduated on the tube itself. Now, whether the tube be depressed, which tends to compress the vapour, or whether it be raised, which tends to expand it, the height of the mercurial column is constant. The tension of the vapour remains constant in the two cases, for the depression neither increases nor diminishes it. Hence it is concluded that when the saturated vapour is compressed, a portion returns to the liquid state; that when, on the other hand, the pressure is diminished, a portion of the excess of liquid vaporises, and the space occupied by the vapour is again saturated; but in both cases the tension and the density of the vapour remain constant.

**343. Non-saturated vapours.**—From what has been said, vapours present two very different states, according as they are saturated or not. In the first case, where they are saturated and in contact with the liquid, they differ completely from gases, since for a given temperature they can neither be compressed nor expanded; their elastic force and their density remain constant.



Fig. 277.

In the second case, on the contrary, where they are not saturated, they exactly resemble gases. For if the experiments (fig. 278) be repeated, only a small quantity of ether being introduced, so that the vapour is not saturated, and if the tube be then slightly raised, the level of the mercury is seen to



Fig. 278.

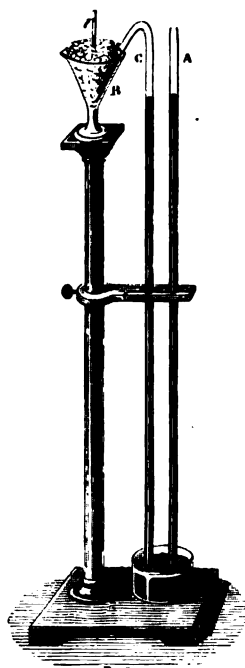

Fig. 279.

rise, which shows that the elastic force of the vapour has diminished. Similarly, by immersing the tube still more, the level of the mercury sinks. The vapour consequently behaves just as a gas would do, its tension diminishes when the volume increases, and *vice versa*; and, as in both cases the volume of the vapour is inversely as the pressure, it is concluded that *non-saturated vapours obey Boyle's law*.

When a non-saturated vapour is heated, its volume increases like that of a gas; and the number 0.00366, which is the coefficient of the expansion of air, may be taken for that of vapours.

Hence we see that the physical properties of unsaturated vapours are comparable with those of permanent gases, and that the formulæ for the compressibility and expansibility of gases (175 and 321) also apply to unsaturated vapours. But it must not be forgotten that there is always a limit of pressure or of cooling at which unsaturated vapours pass into a state of

saturation, and that they have then a maximum of tension and density which can only be exceeded when the temperature rises while they are in contact with the liquid.

344. **Tension of aqueous vapour below zero.**—For the sake of measuring the elastic force of aqueous vapour below zero, Gay-Lussac used two barometer tubes filled with mercury, and placed in the same bath (fig. 279). The straight tube A serves as a barometer; the other B, is bent, so that part of the Torricellian vacuum can be surrounded by a freezing mixture (336). When a little water is admitted into the bent tube, the level of the mercury sinks below that in the tube A to an extent which varies with the temperature of the freezing mixture.

At	0°	the depression is	.	.	.	4.94	millimetres.
"	-10°	"	"	.	.	2.08	"
"	-20°	"	"	.	.	0.84	"
"	-30°	"	"	.	.	0.36	"

These depressions, which must be due to the tension of aqueous vapour in the space BC, show that even at very low temperatures there is always some aqueous vapour in the atmosphere.

Although in the above experiment the part B and the part C are not both immersed in the freezing mixture, we shall presently see that when two communicating vessels are at different temperatures, the tension of the vapour is the same in both, and always corresponds to that of the lowest temperature.

That water evaporates even below zero follows from the fact that wet linen exposed to the air during frost first becomes stiff and then dry, showing that the particles of water evaporate even after the latter has been converted into ice.

345. **Tension of aqueous vapour between zero and one hundred degrees.**—i. *Dalton's method.* Dalton measured the elastic force of aqueous vapour between 0° and 100° by means of the apparatus represented in fig. 280. Two barometer tubes, A and B, are filled with mercury, and inverted in an iron bath full of mercury, and placed on a furnace. The tube A contains a small quantity of water. The tubes are supported in a cylindrical vessel full of water, the temperature of which is indicated by the thermometer. The bath being gradually heated, the water in the cylinder becomes heated too; the water which is in the tube A vaporises, and in proportion as the tension of its vapour increases, the mercury sinks. The depressions of the mercury corresponding to each degree of the thermometer are indicated on the scale E, and in this manner a table of the elastic forces between zero and 100° has been constructed.

ii. *Regnault's method.*—Dalton's method is wanting in precision, for the liquid in the cylinder has not everywhere the same temperature, and consequently the exact temperature of the aqueous vapour is not indicated. Regnault's apparatus is a modification of that of Dalton. The cylindrical vessel is replaced by a large cylindrical zinc drum, MN (fig. 281), in the bottom of which are two tubulures. The tubes A and B pass through these tubulures, and are fixed by caoutchouc collars. The tube containing vapour, B, is connected with a flask, a, by means of a brass three-way tube, O. The



third limb of this tube is connected with a drying tube, D, containing pumice impregnated with sulphuric acid, which is connected with the air-pump.

When the flask *a* contains some water, a small portion is distilled into B by gently heating the flask. Exhausting then, by means of the air-pump, the water distils continuously from the flask and from the barometric tube towards D, which condenses the vapours. After having vaporised some



Fig. 280

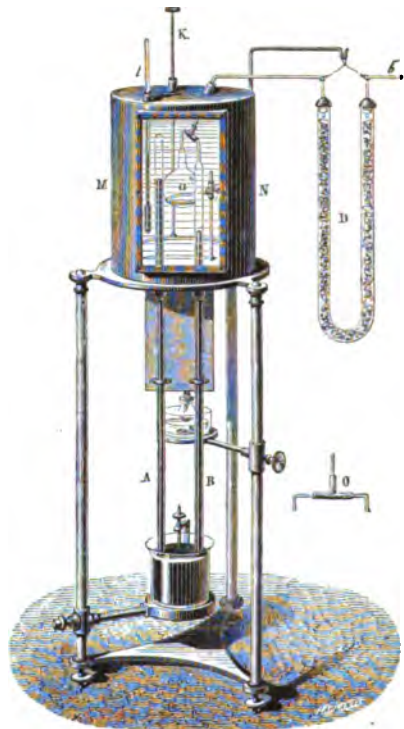

Fig. 281.

quantity of water, and when it is thought that the air in the tube is withdrawn, the capillary tube which connects B with the three-way tube is sealed. The tube B being thus closed, it is experimented with as in Dalton's method.

The drum MN, being filled with water, is gently heated by a spirit lamp, which is separated from the tubes by a wooden screen. By means of a stirrer, K, all parts of the liquid are kept at the same temperature. In the side of the drum is a glass window, through which the height of the mercury in the tubes can be read off by means of a cathetometer; from the difference in these heights, reduced to zero, the tension of vapour is deduced. By means of this apparatus, the elastic force of vapour between  $0^{\circ}$  and  $50^{\circ}$  has been determined with accuracy.

346. **Tension of aqueous vapour above one hundred degrees.**—Two methods have been employed for determining the tension of aqueous vapour at temperatures above  $100^{\circ}$ , the one by Dulong and Arago, in 1830, and the other by Regnault, in 1844.

Fig. 282 represents a vertical section of the apparatus used by Dulong and Arago. It consisted of a copper boiler, *k*, with very thick sides, and of

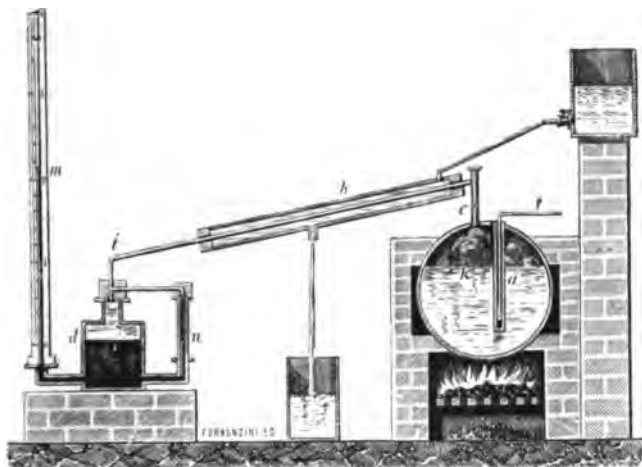

Fig. 282.

about 20 gallons capacity. Two gun-barrels, *a*, of which only one is seen in the drawing, were firmly fixed in the sides of the boiler, and plunged in the water. The gun-barrels were closed below, and contained mercury in which were placed thermometers, *t*, indicating the temperature of the water, and of the vapour. The tension of the vapour was measured by means of a manometer with compressed air, *m*, previously graduated (177) and fitted into an iron vessel, *d*, filled with mercury. In order to see the height of the mercury in the vessel, it was connected above and below with a glass tube, *n*, in which the level was always the same as in the bath. A copper tube, *i*, connected the upper part of the vessel, *d*, with a vertical tube, *c*, fitted in the boiler. The tube *i* and the upper part of the bath *d* were filled with water, which was kept cool by means of a current of cold water flowing from a reservoir, and circulating through the tube *b*.

The vapour which was disengaged from the tube *c* exercised a pressure on the water of the tube *i*; this pressure was transmitted to the water and to the mercury in the bath *d*, and the mercury rose in the manometer. By noting on the manometer the pressures corresponding to each degree of the thermometer, Dulong and Arago were able to make a direct measurement of the tension up to 24 atmospheres, and the tension from thence to 50 atmospheres was determined by calculation.

347. **Tension of vapour below and above one hundred degrees.**—Regnault has devised a method by which the tension of vapour may be

measured at temperatures either below or above  $100^{\circ}$ . It depends on the principle that when a liquid boils, the tension of the vapour is equal to the pressure it supports (352). If, therefore, the temperature and the corresponding pressure are known, the question is solved, and the method merely consists in causing water to boil in a vessel under a given pressure, and measuring the corresponding temperature.

The apparatus consists of a copper retort, C (fig. 283), hermetically sealed and about two-thirds full of water. In the cover there are four thermometers,

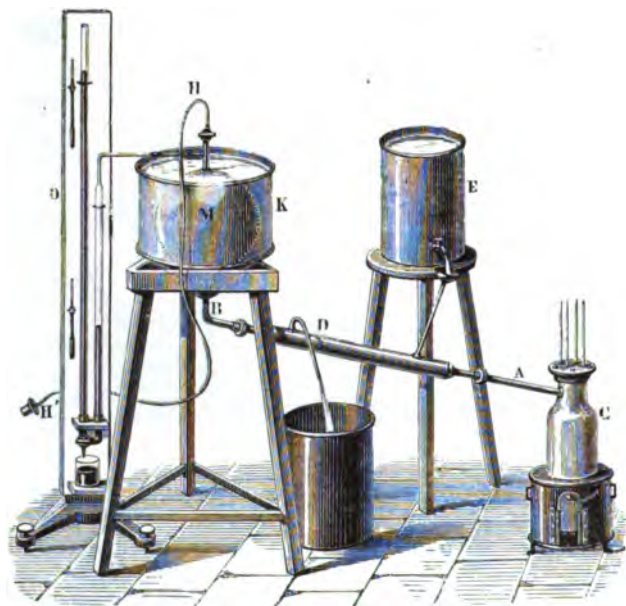

Fig. 283.

two of which just dip into the water, and two descend almost to the bottom. By means of a tube, AB, the retort C is connected with a glass globe, M, of about 6 gallons capacity, and full of air. The tube AB passes through a metallic cylinder, D, through which a current of cold water is constantly flowing from the reservoir E. To the upper part of the globe a tube with two branches is attached, one of which is connected with a manometer, O; the other tube, HH', which is of lead, can be attached either to an exhausting or a condensing air-pump, according as the air in the globe is to be rarefied or condensed. The reservoir K, in which is the globe, contains water of the temperature of the surrounding air.

If the elastic force of aqueous vapour below  $100^{\circ}$  is to be measured, the end H' of the leaden pipe is connected with the plate of the air-pump, and the air in the globe M, and consequently that in the retort C is rarefied. The retort being gently heated, the water begins to boil at a temperature below  $100^{\circ}$ , in consequence of the diminished pressure. And since the

vapour is condensed in the tube AB, which is always cool, the pressure originally indicated by the manometer does not increase, and therefore the tension of the vapour during ebullition remains equal to the pressure on the liquid.

A little air is then allowed to enter; this alters the pressure, and the liquid boils at a new temperature; both these are read off, and the experiment repeated as often as desired up to 100°.

In order to measure the tension above 100°, the tube H' is connected with a condensing pump, by means of which the air in the globe M and that in the vessel C are exposed to successive pressures, higher than the atmosphere. The ebullition is retarded (356), and it is only necessary to observe the difference in the height of the mercury in the two tubes of the manometer O, and the corresponding temperature, in order to obtain the tension for a given temperature.

The following tables by M. Regnault give the tension of aqueous vapour from -10° to 101°.

*Tensions of aqueous vapour from -10° to 101° C.*

Temperatures	Tensions in millimetres	Temperatures	Tensions in millimetres	Temperatures	Tensions in millimetres	Temperatures	Tensions in millimetres
-10°	2·078	12°	10·457	29°	29·782	85°	433·41
8	2·456	13	11·062	30	31·548	90	525·45
6	2·890	14	11·906	31	33·405	91	545·78
4	3·387	15	12·699	32	35·359	92	566·76
2	3·955	16	13·635	33	37·410	93	588·41
0	4·600	17	14·421	34	39·565	94	610·74
+ 1	4·940	18	15·357	35	41·827	95	633·78
2	5·302	19	16·346	40	54·906	96	657·54
3	5·687	20	17·391	45	71·391	97	682·03
4	6·097	21	18·495	50	91·982	98	707·26
5	6·534	22	19·659	55	117·479	98·5	720·15
6	6·998	23	20·888	60	148·791	99·0	733·21
7	7·492	24	22·184	65	186·945	99·5	746·50
8	8·017	25	23·550	70	233·093	100·0	760·00
9	8·574	26	24·998	75	288·517	100·5	773·71
10	9·165	27	26·505	80	354·643	101·0	787·63
11	9·792	28	28·101				

In the second table the numbers were obtained by direct observation up to 24 atmospheres; the others were calculated by the aid of a formula of interpolation.

This table and the one next following show that the elastic force increases much more rapidly than the temperature. It has been attempted to express the relation between them by formulæ, but none of the formulæ seem to have the simplicity which characterises a true law.

## Tensions in atmospheres from 100° to 230°.

Temperatures	Number of atmospheres	Temperatures	Number of atmospheres	Temperatures	Number of atmospheres	Temperatures	Number of atmospheres
100°0	1	170°8	8	198°8	15	217°9	22
112°2	1½	175°8	9	201°9	16	220°3	23
120°6	2	180°3	10	204°9	17	222°5	24
133°9	3	184°5	11	207°7	18	224°7	25
144°0	4	188°4	12	210°4	19	226°8	26
152°2	5	192°1	13	213°0	20	228°9	27
156°2	6	195°5	14	215°5	21	230°9	28
165°3	7						

348. **Tension of the vapours of different liquids.**—Regnault has determined the elastic force, at various temperatures, of a certain number of liquids which are given in the following table :—

Liquids	Temperatures	Tensions in millimetres	Liquids	Temperatures	Tension in millimetres
Mercury .	50°	0·11	Ether . .	-20°	68
	100	0·74		0	182
Alcohol .	0	13		60	1728
	50	220	100	4950	
	100	1695	Sulphurous acid	-20	479
-20	43	0		1165	
Bisulphide of carbon	0	132		60	8124
	60	1164	-30	876	
	100	3329	0	3163	
			30	8832	
			Ammonia		

349. **Tension of the vapours of mixed liquids.**—Regnault's experiments on the tension of the vapour of mixed liquids prove that (i.) when two liquids exert no solvent action on each other—such as water and *bisulphide of carbon*, or water and *benzole*—the tension of the vapour which rises from them is nearly equal to the sum of the tensions of the two separate liquids at the same temperature ; (ii.) with water and *ether*, which partially dissolve each other, the tension of the mixture is much less than the sum of the tensions of the separate liquids, being scarcely equal to that of the ether alone ; (iii.) when two liquids dissolve in all proportions, as ether and bisulphide of carbon, or water and alcohol, the tension of the vapour of the mixed liquid is intermediate between the tensions of the separate liquids.

Willner has shown that the tension of aqueous vapour emitted from a saline solution, as compared with that of pure water, is diminished by an amount proportional to the quantity of anhydrous salt dissolved, when the salt crystallises without water or yields efflorescent crystals ; when the salt is deliquescent, or has a powerful attraction for water, the reduction of tension is proportional to the quantity of crystallised salt.

350. **Tension in two communicating vessels at different temperatures.**

—When two vessels containing the same liquid, but at different temperatures, are connected with each other, the elastic force is not that corresponding to the mean of the two temperatures, as would naturally be supposed. Thus, if there are two globes, fig. 284, one, A, containing water kept at zero by

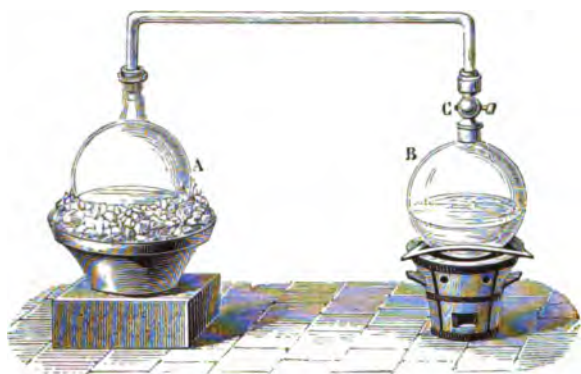

Fig. 284.

means of melting ice, the other, B, containing water at  $100^{\circ}$ , the tension, as long as the globes are not connected, is 4 to 6 millimetres in the first, and 760 millimetres in the second. But when they are connected by opening the stopcock C, the vapour in the globe B, from its greater tension, passes into the other globe, and is there condensed, so that the vapour in B can never reach a higher temperature than that in the globe A. The liquid simply distils from B towards A without any increase of tension.

From this experiment the general principle may be deduced that *when two vessels containing the same liquid, but at different temperatures, are connected, the tension is identical in both vessels, and is the same as that corresponding to the lower temperature.* An application of this principle has been made by Watt in the condenser of the steam-engine.

351. **Evaporation. Causes which accelerate it.**—*Evaporation*, as has been already stated (339), is the slow production of vapour at the surface of a liquid. It is in consequence of this evaporation that wet clothes dry when exposed to the air, and that open vessels containing water become emptied. The vapours which, rising in the atmosphere, condense, and, becoming clouds, fall as rain, are due to the evaporation from the seas, lakes, rivers, and the soil.

Four causes influence the rapidity of the evaporation of a liquid : i. the temperature ; ii. the quantity of the same vapour in the surrounding atmosphere ; iii. the renewal of this atmosphere ; iv. the extent of the surface of evaporation.

Increase of temperature accelerates the evaporation by increasing the elastic force of the vapours.

In order to understand the influence of the second cause, it is to be observed that no evaporation could take place in a space already saturated with vapour of the same liquid, and that it would reach its maximum in air completely freed from this vapour. It therefore follows that between these two extremes the rapidity of evaporation varies according as the surrounding atmosphere is already more or less charged with the same vapour.



Fig. 285.

The effect of the renewal of this atmosphere is similarly explained; for if the air or gas, which surrounds the liquid, is not renewed, it soon becomes saturated, and evaporation ceases.

The influence of the fourth cause is self-evident.

**352. Laws of ebullition.**—*Ebullition*, or *boiling*, is the rapid production of elastic bubbles of vapour in the mass of a liquid itself.

When a liquid, water for example, is heated at the lower part of a vessel, the first bubbles are due to the disengagement of air which had previously been absorbed. Small bubbles of vapour then begin to rise from the heated parts of the sides, but as they pass through the upper layers, the temperature of which is lower, they condense before reaching the surface. The formation and successive condensation of these first bubbles occasion the *singing* noticed in liquids before they begin to boil. Lastly, large bubbles rise and burst on the surface, and this constitutes the phenomenon of ebullition (fig. 285).

The laws of ebullition have been determined experimentally, and are as follows:—

I. *The temperature of ebullition, or the boiling point, increases with the pressure.*

II. *For a given pressure ebullition begins at a certain temperature, which varies in different liquids, but which, for equal pressures, is always the same in the same liquid.*

III. *Whatever be the intensity of the source of heat, as soon as ebullition begins, the temperature of the liquid remains stationary.*

*Boiling points under the pressure 760 millimetres.*

Sulphurous acid . . . . .	- 10°	Turpentine . . . . .	160°
Chloride of ethyle . . . . .	+ 11	Butyric acid . . . . .	157
Ether . . . . .	37	Phosphorus . . . . .	290
Bisulphide of carbon . . . . .	48	Strong sulphuric acid . . . . .	325
Bromine . . . . .	63	Mercury . . . . .	320
Alcohol . . . . .	78	Sulphur . . . . .	447
Distilled water . . . . .	100	Cadmium . . . . .	860
Acetic acid . . . . .	117	Zinc . . . . .	1040

There are many causes which influence the boiling point of a liquid, such as the substances dissolved, the nature of the vessel, and the pressure. We shall illustrate the effects of these different causes, more particularly on water.

Kopp has pointed out that in analogous chemical compounds the same difference in chemical composition frequently involves the same difference of boiling points; and he has endeavoured to show that in a very extensive series of compounds the difference of  $\text{CH}^2$  is attended by a difference of  $19^\circ \text{C}$ . in the boiling point.

**353. Theoretical explanation of evaporation and ebullition.**—From what has been said about the nature of the motion of the molecules in liquids (284), it may readily be conceived that in the great variety of these motions, the case occurs in which by a fortuitous concurrence of the progressive vibratory and rotatory motions a molecule is projected from the surface of the liquid with such force that it overleaps the sphere of the action of its circumjacent molecules before, by their attraction, it has lost its initial velocity; and that it then flies into the space above the liquid.

Let us first suppose this space limited and originally vacuous, it gradually fills with the propelled molecules which act like a gas and in their motion are driven against the sides of the envelope. One of these sides, however, is the surface of the liquid itself, and a molecule when it strikes against this surface will not in general be repelled but be retained by the attraction which the adjacent ones exert. Equilibrium will be established when as many molecules are dispersed in the surrounding space as, on the average, impinge against the surface and are retained by it in the unit of time. This state of equilibrium is not, however, one of rest, in which evaporation has ceased, but a condition in which evaporation and condensation, which are equally strong, continually compensate each other.

The density of a vapour depends on the number of molecules which are repelled in a given time, and this manifestly depends on the motion of the molecules in the liquid.

What has been said respecting the surface of the liquid clearly applies to other sides of the vessel within which the vapour is formed; some vapour is condensed, this is subject to evaporation, and a condition ultimately occurs in which evaporation and precipitation are equal. The quantity of vapour necessary for this depends on the density of vapour in the closed space, on the temperature of the vapour and the side and on the force with which this attracts the molecules. The maximum will be reached when the sides are covered with a layer of liquid, which then acts like the free surface of a liquid.

In the interior of a liquid it may happen that the molecules repel each other with such force as to momentarily destroy the coherence of the mass. The small vacuous space which is thereby formed is entirely surrounded by a medium which does not allow of the passage of the repelled molecules. Hence it cannot increase and maintain itself as a bubble of vapour, unless so many molecules are projected from the inner sides that the internal pressure which thereby results can balance the external pressure which tends to condense the bubble. The expansive force of the enclosed vapour must therefore be so much the greater, the greater the external pressure on the



liquid, and thus we see the dependence of pressure on the temperature of boiling.

**354. Influence of substances in solution on the boiling point.**—The ebullition of a liquid is the more retarded the greater the quantity of any substance it may contain in solution, provided that the substance be not volatile, or, at all events, be less volatile than the liquid itself. Water, which boils at  $100^{\circ}$  when pure, boils at the following temperatures when saturated with different salts :—

Water saturated with common salt	boils at $109^{\circ}$
"    "    nitrate of potassium	" $116$
"    "    carbonate of potassium	" $135$
"    "    chloride of calcium	" $179$

Acids in solution present analogous results ; but substances merely mechanically suspended, such as earthy matters, bran, wooden shavings, etc., do not affect the boiling point.

Dissolved air exerts a very marked influence on the boiling point of water. Deluc first observed that water freed from air by ebullition, and placed in a flask with a long neck, could be raised to  $112^{\circ}$  without boiling. M. Donny examined this phenomenon by means of the apparatus depicted in figure 286. It consists of a glass tube CAB, bent at one end and closed at



Fig. 286.

C, while the other is blown into a pear-shaped bulb, B, drawn out to a point. The tube contains water which is boiled until all air is expelled, and the open end is then hermetically sealed. By inclining the tube the water passes into the bent end CA ; this end being placed in a bath of chloride of calcium the temperature may be raised to  $130^{\circ}$  without any signs of boiling. At  $138^{\circ}$  the liquid is suddenly converted into steam and the water is drawn over into the bulb which is smashed if not sufficiently strong.

Boiled out water, covered with a layer of oil, may be raised to  $120^{\circ}$  without boiling, but above this temperature it suddenly begins to boil, and with almost explosive violence.

When a liquid is suspended in another of the same specific gravity, but higher boiling point, with which it does not mix, it may be raised far beyond its boiling point without the formation of a trace of vapour. Dufour has made a number of valuable experiments on this subject ; he used in the case of water a mixture of oil of cloves and linseed oil ; and placed in it globules of water, and then gradually heated the oil ; in this way ebullition rarely set in below  $110^{\circ}$  or  $115^{\circ}$  ; very commonly globules of 10 millimetres diameter reached a temperature of  $120^{\circ}$  or  $130^{\circ}$ , while very small globules of 1 to 3 millimetres reached the temperature of  $175^{\circ}$ , a temperature at which the tension of vapour on a free surface is 8 or 9 atmospheres.

At these high temperatures the contact of a solid body, or the production

of gas bubbles in the liquid, occasioned a sudden vaporisation of the globule, accompanied by a sound like the hissing of a hot iron in water.

Saturated aqueous solutions of sulphate of copper, chloride of sodium, etc., remained liquid at a temperature far beyond their boiling point, when immersed in melted stearic acid. In like manner, globules of chloroform (which boils at  $61^{\circ}$ ) suspended in a solution of chloride of zinc could be heated to  $97^{\circ}$  or  $98^{\circ}$  without boiling.

It is a disputed question as to what is the temperature of the vapour from boiling saturated saline solutions. It has been stated by Rudberg to be that of pure water boiling under the same pressure; the most recent experiments of Magnus seem to show, however, that this is not the case, but that the vapour of boiling solutions is hotter than that of pure water; and that the temperature rises as the solutions become more concentrated, and therefore boil at higher temperatures. Nevertheless, the vapour was always found somewhat cooler than the mass of the boiling solution, and the difference was greater at high than at low temperatures.

The boiling point of a liquid is usually lowered when it is mixed with a more volatile liquid than itself, but raised when it contains one which is less volatile. Thus a mixture of two parts alcohol and one of water boils at  $83^{\circ}$ , a mixture of two parts of bisulphide of carbon and one part of ether boils at  $38^{\circ}$ . In some cases the boiling point of a mixture is lower than that of either of its constituents. A mixture of water and bisulphide boils at  $43^{\circ}$ , the boiling point of the latter being  $46^{\circ}$ . On this depends the following curious experiment. If water and bisulphide of carbon, both at the temperature  $45^{\circ}$ , are mixed together, the mixture at once begins to boil briskly.

**355. Influence of the nature of the vessel on the boiling point.**—Gay-Lussac observed that water in a glass vessel required a higher temperature for ebullition than in a metal one. Taking the temperature of boiling water in a copper vessel at  $100^{\circ}$ , its boiling point in a glass vessel was found to be  $101^{\circ}$ ; and if the glass vessel had been previously cleaned by means of sulphuric acid and of potass, the temperature would rise to  $105^{\circ}$ , or even to  $106^{\circ}$ , before ebullition commenced. A piece of metal placed in the bottom of the vessel was always sufficient to lower the temperature to  $100^{\circ}$ , and at the same time to prevent the violent concussions which accompany the ebullition of saline or acid solutions in glass vessels. Whatever be the boiling point of water, the temperature of its vapour is uninfluenced by the substance of the vessels.

**356. Influence of pressure on the boiling point.**—We see from the table of tensions (347) that at  $100^{\circ}$ , the temperature at which water boils under a pressure of 760 millimetres, aqueous vapour has a tension exactly equal to this pressure. This principle is general, and may be thus enunciated: *A liquid boils when the tension of its vapour is equal to the pressure it supports.* Consequently, as the pressure increases or diminishes, the tension of the vapour, and therefore the temperature necessary for ebullition, must increase or diminish.

In order to show that the boiling point is lower under diminished pressure, a small dish containing water at  $30^{\circ}$  is placed under the receiver of an air-pump, which is then exhausted. The liquid soon begins to boil, the vapour formed being pumped out as rapidly as it is generated.

A paradoxical but very simple experiment also well illustrates the dependence of the boiling point on the pressure. In a glass flask, water is boiled for some time, and when all air has been expelled by the steam, the flask is closed by a cork and inverted as shown in fig. 287. If the bottom is then cooled by a stream of cold water from a sponge, the water begins to boil again. This arises from the condensation of the steam above the surface of the water, by which a partial vacuum is produced.



Fig. 287.

It is in consequence of this diminution of pressure that liquids boil on high mountains at lower temperatures. On Mont Blanc, for example, water boils at  $84^{\circ}$ , and at Quito at  $90^{\circ}$ .

On the more rapid evaporation of water under feeble pressures is based the use of the air-pump in concentrating those solutions which either cannot bear a high degree of heat, or which can be more cheaply evaporated in an exhausted space. Howard made a most important and useful application of this principle in the manufacture of sugar. The syrup, in his method, is enclosed in an air-tight vessel, which is exhausted by a steam-engine. The evaporation consequently goes on at a lower temperature, which secures the syrup from injury. The same plan is adopted in evaporating the juice of certain plants used in preparing medicinal extracts.

On the other hand, ebullition is retarded by increasing the pressure : under the pressure of two atmospheres, for example, water only boils at  $120^{\circ}6$ .

357. **Franklin's experiment.**—The influence of pressure on ebullition may further be illustrated by means of an experiment of Franklin's. The apparatus consists of a bulb, *a*, and a tube, *b*, joined by a tube of smaller dimensions (fig. 288). The tube *b* is drawn out, and the apparatus filled with water, which is then in great part boiled away by means of a spirit lamp. When it has been boiled sufficiently long to expel all the air, the tube *b* is sealed. There is then a vacuum in the apparatus, or rather there is a pressure due to the tension of aqueous vapour, which at ordinary

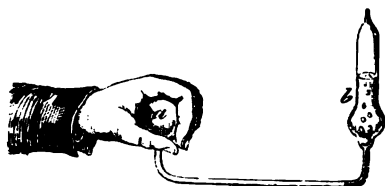

Fig. 288.

temperatures is very small. Consequently, if the bulb *a* be placed in the hand, the heat is sufficient to produce a tension which drives the water into the tube *b*, and causes a brisk ebullition.

358. **Measurement of heights by the boiling point.**—From the connection between the boiling point of water and the pressure, the heights of mountains may be measured by the thermometer instead of by the barometer. Suppose, for example, it is found that water boils on the summit of a mountain at  $90^{\circ}$ , and at its base at  $98^{\circ}$ ; at these temperatures the elastic force or tension of the vapour is equal to that of the pressure on the liquid, that is, to the pressure of the atmosphere at the two places respectively. Now the tensions of aqueous vapour for various temperatures have been determined, and accordingly the tensions corresponding to the above temperatures are sought in the tables. These numbers represent the atmospheric pressures at the two places: in other words, they give the barometric heights, and from these the height of the mountain may be calculated by the method already given (171). An ascent of about 1080 feet produces a diminution of  $1^{\circ}$  C. in the boiling point.

The instruments used for this purpose are called *thermo-barometers* or *Aypsometers*, and were first applied by Wollaston. They consist essentially of a small metallic vessel for boiling water, fitted with very delicate thermometers, which are only graduated from  $80^{\circ}$  to  $100^{\circ}$ ; so that each degree occupying a considerable space on the scale, the 10ths, and even the 100ths, of a degree may be estimated, and thus it is possible to determine the height of a place by means of the boiling point to within about 10 feet.

359. **Formation of vapour in a closed tube.**—We have hitherto considered vapours as being produced in an indefinite space, or where they could expand freely, and it is only under this condition that ebullition can take place. In a closed vessel the vapours produced finding no issue, their tension and their density increase with the temperature, but the rapid disengagement of vapour which constitutes ebullition is impossible. Hence, while the temperature of a liquid in an open vessel can never exceed that of ebullition, in a closed vessel it may be much higher. The liquid state has, nevertheless, a limit; for, according to experiments by Cagniard-Latour, if either water, alcohol, or ether be placed in strong glass tubes, which are hermetically sealed after the air has been expelled by boiling, and if then these tubes are exposed to a sufficient degree of heat, a moment is reached at which the liquid suddenly disappears, and is converted into vapour at  $200^{\circ}$ , occupying a space less than double its volume in the liquid state, its tension being then 38 atmospheres.

Alcohol which half fills a tube is converted into vapour at  $207^{\circ}$  C. If a glass tube about half filled with water, in which some carbonate of soda has been dissolved, to diminish the action of the water in the glass, be heated, it is completely vaporised at about the temperature of melting zinc.

When chloride of ethyle is heated in a very thick sealed tube, the upper surface ceases to be distinct at  $170^{\circ}$ , and is replaced by an ill-defined nebulous zone. As the temperature rises this zone increases in width in both directions, becoming at the same time more transparent; after a time the liquid is completely vaporised, and the tube becomes transparent and seemingly empty. On cooling, the phenomena are reproduced in the opposite order. Similar appearances are observed on heating ether in a sealed tube at  $190^{\circ}$ .

Andrews has observed that when liquid carbonic acid was heated in a closed tube to  $31^{\circ}$  C. the surface of demarcation between the liquid and the gas became fainter, lost its curvature, and gradually disappeared. The space was then occupied by a homogeneous fluid, which, when the pressure was suddenly diminished, or the temperature slightly lowered, exhibited a peculiar appearance of moving or flickering striæ throughout its whole mass. Above  $30^{\circ}$  no apparent liquefaction of carbonic anhydride, or separation into two distinct forms of matter, could be effected, not even when the pressure of 400 atmospheres was applied. It would thus seem that there exists for every liquid a temperature, the *critical* temperature. While below this critical point a sudden transition from gas to liquid is accompanied by a sudden diminution of volume, and liquid and gas are separated by a sharp line of demarcation; above this critical point the change is connected with a gradual diminution of volume, and is quite imperceptible. The condensation can, indeed, only be recognised by a sudden ebullition when the pressure is lessened. Hence, ordinary condensation is only possible below the critical point, and it is not surprising, therefore, that mere pressure, however great, should fail to liquefy many of the bodies which usually exist as gases.

360. **Papin's digester.**—Papin, a French physician, appears to have been the first to study the effects of the production of vapour in closed vessels.



Fig. 289.

The apparatus which bears his name consists of a cylindrical iron vessel (fig. 289), provided with a cover, which is firmly fastened down by the screw B. In order to close the vessel hermetically, sheet lead is placed between the edges of the cover and the vessel. At the bottom of a cylindrical cavity, which traverses the cylinder S, and the tubulure o, the cover is perforated by a small orifice in which there is a rod n. This rod presses against a lever, A, movable at a, and the pressure may be regulated by means of a weight movable on this lever. The lever is so weighted, that when the tension in the interior is equal to 6 atmospheres, for example, the valve rises and the vapour escapes. The destruction of the apparatus is thus avoided, and this mechanism has hence received the name of *safety valve*. The digester is filled about two-thirds with water, and is heated on a furnace. The water may thus be raised to

a temperature far above  $100^{\circ}$ , and the tension of the vapour increased to several atmospheres, according to the weight on the lever.

We have seen that water boils at much lower temperatures on high mountains (356), the temperature of water boiling in open vessels in such localities is not sufficient to soften animal fibre completely and extract the nutriment, and hence Papin's digester is used in the preparation of food.

Papin's digester is used in extracting gelatine. When bones are digested in this apparatus they are softened so that the gelatine which they contain is dissolved. The use of the digester is extending in Germany; the part through which the screw B passes is made of such elasticity that it yields, and the lid opens when the pressure of the vapour becomes dangerous.

361. **Latent heat of vapour.**—As the temperature of a liquid remains constant during ebullition, whatever be the source of heat (352), it follows that a considerable quantity of heat becomes absorbed in ebullition, the only effect of which is to transform the body from the liquid to the gaseous condition. And conversely when a saturated vapour passes into the state of liquid it gives out a definite amount of heat.

These phenomena were first observed by Black, and he described them by saying that during vaporisation a quantity of sensible heat became latent, and that the latent heat again became free during condensation. The quantity of heat which a liquid must absorb in passing from the liquid to the gaseous state, and which it gives out in passing from the state of vapour to that of liquid, is spoken of as the *latent heat of evaporation*.

The analogy of these phenomena to those of fusion will be at once seen; the modes of determining them will be described in the chapter on Calorimetry; but the following results, which have been obtained for the latent heats of evaporation of a few liquids, may be here given :—

Water . . . . .	536	Bisulphide of carbon . . . . .	87
Alcohol . . . . .	208	Turpentine . . . . .	74
Acetic acid . . . . .	102	Bromine . . . . .	46
Ether . . . . .	90	Iodine . . . . .	24

The meaning of these numbers is, in the case of water, for instance, that it requires as much heat to convert a pound of water from the state of liquid at the boiling point to that of vapour at the same temperature, as would raise a pound of water through 540 degrees, or 540 pounds of water through one degree; or that the conversion of one pound of vapour of alcohol at 78° into liquid alcohol of the same temperature would heat 208 pounds of water through *one* degree.

Watt, who investigated the subject, found that *the whole quantity of heat necessary to raise a given weight of water from zero at any temperature and then to evaporate it entirely, is a constant quantity*. His experiments showed that this quantity is 640. Hence the lower the temperature the greater the latent heat, and, on the other hand, the higher the temperature the less the latent heat. The latent heat of the vapour of water evaporated at 100° would be 540, while at 50° it would be 590. At higher temperatures the latent heat of aqueous vapour would go on diminishing. Water evaporated under a pressure of 15 atmospheres at a temperature of 200°, would have a latent heat of 440, and if it could be evaporated at 640° it would have no latent heat at all.

Experiments by Southern and Creighton in 1803 led to a different conclusion: namely, that *the latent heat of evaporation is a constant quantity for all temperatures, and that the total quantity of heat necessary to evaporate water is the sensible heat plus the constant*, which they found in round numbers to be 540; consequently, to evaporate water at 100°, 640 thermal units

(420) would be needed, while it would require  $200 + 540 = 740$  thermal units to evaporate it at  $200^\circ$ .

Regnault, who examined this question with great care, arrived at results which differed from both these laws. He found that the *total quantity of heat necessary for the evaporation of water increases with the temperature*, and is not constant, as Watt had supposed. It is represented by the formula

$$Q = 606.5 + 0.305 T,$$

in which  $Q$  is the total quantity of heat, and  $T$  the temperature of the water during evaporation, while the numbers are constant quantities. The total quantity of heat necessary to evaporate water at  $100^\circ$  is  $606.5 + (0.305 \times 100) = 637$ ; at  $120^\circ$  it is 643; at  $150^\circ$  it is 651; and at  $180^\circ$  it is 661.

Thus the heat required to raise a pound of water from zero and convert it into steam at  $100^\circ$  represents a mechanical work of 885430 units, which would be sufficient to raise a ton weight through a height of nearly 400 feet.

The total heat of the evaporation of ether is expressed by a formula similar to that of water, namely,  $Q = 94 + 0.045t$ ; and that for chloroform  $Q = 67 + 0.1375t$ .

**362. Cold due to evaporation. Mercury frozen.**—Whatever be the temperature at which a vapour is produced, an absorption of heat always takes place. If, therefore, a liquid evaporates, and does not receive from without a quantity of heat equal to that which is expended in producing the vapour, its temperature sinks, and the cooling is greater in proportion as the evaporation is more rapid.

Leslie succeeded in freezing water by means of rapid evaporation. Under the receiver of the air pump is placed a vessel containing strong sulphuric acid, and above it a thin metal capsule A (fig. 290) containing a small



Fig. 290.

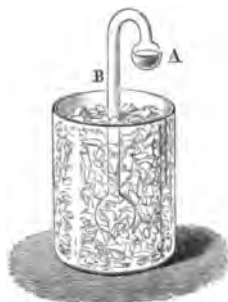

Fig. 291.

quantity of water. By exhausting the receiver the water begins to boil (356), and since the vapours are absorbed by the sulphuric acid as fast as they are formed, a rapid evaporation is produced, which quickly effects the freezing of the water.

This experiment is best performed by using, instead of a thin metallic

vessel, a watch-glass, coated with lampblack and resting on a cork. The advantage of this is twofold : firstly, the lampblack is a very bad conductor, and, secondly, it is not moistened by the liquid, which remains in the form of a globule not in contact with the glass. A small porous dish may advantageously be used.

The same result is obtained by means of Wollaston's *cryophorus* (fig. 291), which consists of a bent glass tube provided with a bulb at each end. The apparatus is prepared by introducing a small quantity of water, which is then boiled so as to expel all air. It is then hermetically sealed, so that on cooling it contains only water and the vapour of water.

The water being introduced into the bulb A, the other is immersed in a freezing mixture. The vapours in the tube are thus condensed ; the water in A rapidly yields more. But this rapid production of vapour requires a large amount of heat, which is abstracted from the water in A, and its temperature is so much reduced that it freezes.

By using liquids more volatile than water, more particularly liquid sulphurous acid, which boils at  $-10^{\circ}$ , a degree of cold is obtained sufficiently intense to freeze mercury. The experiment may be made by covering the bulb of a thermometer with cotton wool, and after having moistened it with liquid sulphurous acid, placing it under the receiver of the air pump. When a vacuum is produced the mercury is quickly frozen.

Thilorier, by directing a jet of liquid carbonic acid on the bulb of an alcohol thermometer, obtained a cold of  $-100^{\circ}$  without freezing the alcohol. We have already seen, however (332), that with a mixture of solid carbonic acid, liquid protoxide of nitrogen and ether, Despretz obtained a sufficient degree of cold to reduce alcohol to the viscous state.

By means of the evaporation of bisulphide of carbon, the formation of ice may be illustrated without the aid of an air-pump. A little water is dropped on a board, and a capsule of thin copper foil, containing bisulphide of carbon, is placed on the water. The evaporation of the bisulphide is accelerated by means of a pair of bellows, and after a few minutes the water freezes round the capsule, so that the latter adheres to the wood.

In like manner, if some water be placed in a test tube which is then dipped in a glass containing some ether, and a current of air be blown through the ether by means of a glass tube fitted to the nozzle of a pair of bellows, the rapid evaporation of the ether very soon freezes the water in the tube. Richardson's apparatus for producing local anæsthesia also depends on the cold produced by the evaporation of ether.

The cold produced by evaporation is used in hot climates to cool water by means of *alcarrazas*. These are porous earthen vessels, through which water percolates, so that on the outside there is a continual evaporation which is accelerated when the vessels are placed in a current of air. For the same reason wine is cooled by wrapping the bottles in wet cloths and placing them in a draught.

In Harrison's method of making ice artificially, a steam-engine is used to work an air-pump, which produces a rapid evaporation of some ether, in which is immersed the vessel containing the water to be frozen. The apparatus is so constructed that the vaporised ether can be condensed and used again.



The cooling effect produced by a wind or draught does not necessarily arise from the wind being cooler, for it may, as shown by the thermometer, be actually warmer; but arises from the rapid evaporation. It causes from the surface of the skin. We have the feeling of oppression, even at moderate temperatures, when we are in an atmosphere saturated by moisture, in which no evaporation takes place.

363. **Carré's apparatus for freezing water.**—We have already seen that when any liquid is converted into vapour it absorbs a considerable quantity of sensible heat; this furnishes a source of cold which is the more abundant the more volatile the liquid and the greater its heat of vapourisation.

This property of liquids has been utilised by M. Carré, in freezing water by the distillation of ammonia. The apparatus consists of a cylindrical boiler C (figs. 292, 293) and of a slightly conical vessel A, which is the *freezer*.



Fig. 292.

Fig. 293.

These two vessels are connected by a tube *m*, and a brace *n*, binds them firmly. They are made of strong galvanised iron plate, and can resist a pressure of seven atmospheres.

The boiler C, which holds about two gallons, is three parts filled with a strong solution of ammonia. In a tubulure in the upper part of the boiler some oil is placed, and in this a thermometer *t*. The freezer A consists of two concentric envelopes, in such a manner that, its centre being hollow, a metal vessel G, containing the water to be frozen, can be placed in this space. Hence only the annular space between the sides of the freezer is in communication with the boiler by means of the tube *m*. In the upper part of the freezer there is a small tubulure, which can be closed by a metal stopper, and by which the solution of ammonia is introduced.

The formation of ice comprehends two distinct operations. In the first, the boiler is placed in a furnace F, and the freezer in a bath of cold water of about  $12^{\circ}$ . The boiler being heated to  $130^{\circ}$ , the ammoniacal gas dissolved

in the water of the boiler is disengaged, and, in virtue of its own pressure, is liquefied in the freezer, along with about a tenth of its weight of water. This distillation of C towards A lasts about an hour and a quarter, and when it is finished the second operation commences; this consists in placing the boiler in the cold-water bath (fig. 293), and the freezer outside, care being taken to surround it with very dry flannel. The vessel G, about three-quarters full of water, is placed in the freezer. As the boiler cools, the ammoniacal gas with which it is filled is again dissolved; the pressure thus being diminished, the ammonia which has been liquefied in it is converted into the gaseous form, and now distils from A towards C, to redissolve in the water which has remained in the boiler. During this distillation the ammonia which is gasified absorbs a great quantity of heat, which is withdrawn from the vessel G and the water it contains. Hence it is that this water freezes. In order to have better contact between the sides of the vessel G and the freezer, alcohol is poured between them. In about an hour and a quarter a perfectly compact cylindrical block of ice can be taken from the vessel G.

This apparatus gives about four pounds of ice in an hour, at a price of about a farthing per pound; large continuously working apparatus have, however, been constructed, which produce as much as 800 pounds of ice in an hour.

Carré has constructed an ice-making machine which is an industrial application of Leslie's experiment, and by which considerable quantities of



Fig. 294.

water may be frozen in a short time. It consists of a cylinder R about 15 inches long by four in diameter, made of an alloy of lead and antimony

(fig. 294). At one end is a funnel E, by which strong sulphuric acid can be introduced ; at the other is a tubulure *m*, to which is screwed a dome *d* that supports a series of obstacles intended to prevent any sulphuric acid from spirting into *m* and *b*. There are, moreover, on the receiver a wide tube *u*, closed by a thick glass disc O, and a long tube *h*, to the top of which is fitted the bottle C containing water to be frozen. The dome *d*, the disc O, and the stopper *i* of the funnel E are all sealed with wax.

On the side of the receiver is an air-pump P, connected with it by a tube *b*, and worked by a handle M. To this handle is attached a rod *l*, which by the mechanism represented on the left of the figure works a stirrer A in the sulphuric acid. A lever *x* connected with a horizontal axis which traverses a small stuffing-box *n*, transmits its backward and forward motion to the rod *l* and to the stirrer. This and the stuffing-box *n* is fitted in a tubulure on the side of the tubulure *m*.

The smallest size which M. Carré makes contains 2·5 kilogrammes of sulphuric acid, and the water bottle about 400 grammes when it is one-third full. After about 70 strokes of the piston the water begins to boil ; the acid being in continued agitation, the vapour is rapidly absorbed by it, and the pump is worked until freezing begins. For this purpose it is merely necessary to give a few strokes every five minutes. The rate of freezing depends on the strength of the acid ; when this gets very dilute it requires renewal ; but 12 water bottles can be frozen with the same quantity of acid.

#### LIQUEFACTION OF VAPOURS AND GASES.

364. **Liquefaction of vapours.**—The *liquefaction* or *condensation* of vapours is their passage from the aëriiform to the liquid state. Condensation may be due to three causes—cooling, compression, or chemical affinity. For the first two causes the vapours must be saturated (343), while the latter produces the liquefaction of the most rarefied vapours. Thus, a large number of salts absorb and condense the aqueous vapour in the atmosphere, however small its quantity.

When vapours are condensed, their latent heat becomes free, that is, it affects the thermometer. This is readily seen when a current of steam at 100° is passed into a vessel of water at the ordinary temperature. The liquid becomes rapidly heated, and soon reaches 100°. The quantity of heat given up in liquefaction is equal to the quantity absorbed in producing the vapour.

365. **Distillation. Stills.**—*Distillation* is an operation by which a volatile liquid may be separated from substances which it holds in solution, or by which two liquids of different volatilities may be separated. The operation depends on the transformation of liquids into vapours by the action of heat, and on the condensation of these vapours by cooling.

The apparatus used in distillation is called a *still*. Its form may vary greatly, but it consists essentially of three parts : 1st, the *body*, A, (fig. 295), a copper vessel containing the liquid, the lower part of which fits in the furnace : 2nd, the *head*, B, which fits on the body, and from which a lateral tube, C, leads to, 3rd, the *worm*, S, a long spiral tin or copper tube,

placed in a cistern kept constantly full of cold water. The object of the worm is to condense the vapour, by exposing a greater extent of cold surface.



Fig. 295.

To free ordinary well water from the many impurities which it contains, it is placed in a still and heated. The vapours disengaged are condensed

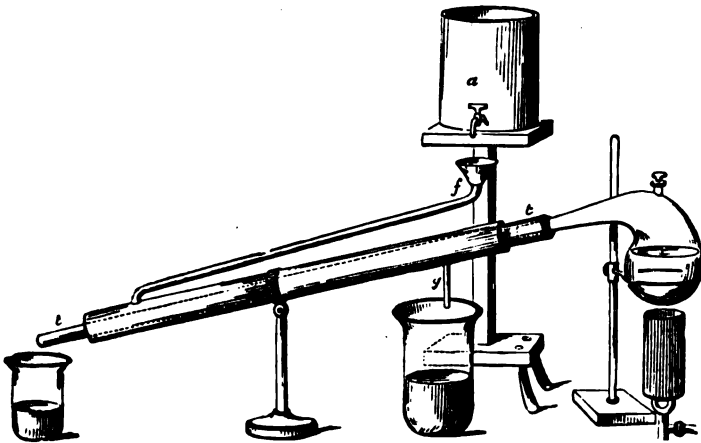

Fig. 206.

in the worm, and the distilled water arising from the condensation is collected in the receiver D. The vapours in condensing rapidly heat the

water in the cistern, which must, therefore, be constantly renewed. For this purpose a continual supply of cold water passes into the bottom of the cistern, while the lighter heated water rises to the surface and escapes by a tube in the top of the cistern.

366. **Liebig's condenser.**—In distilling smaller quantities of liquids, or in taking the boiling point of a liquid, so as not to lose any of it, the apparatus known as *Liebig's condenser* is extremely useful. It consists of a glass tube, *tt*, fig. 296, about thirty inches long, fitted in a copper or tin tube by means of perforated corks. A constant supply of cold water from the vessel *a* passes into the space between the two tubes, being conveyed to the lower part of the condenser by a funnel and tube *f*, and flowing out from the upper part of the tube *g*. The liquid to be distilled is contained in a retort, the neck of which is placed in the tube; the condensed liquid drops quite cold into a vessel placed to receive it at the other extremity of the condensing tube.

367. **Apparatus for determining the alcoholic value of wines.**—One of the forms of this apparatus consists of a glass flask resting on a tripod, and heated by a spirit lamp (fig. 297). By means of a caoutchouc tube this



Fig. 297.

is connected with a worm placed in a copper vessel filled with cold water, and below which is a test-glass for collecting the distillate. On this are three divisions, one *a*, which measures the quantity of wine taken; the two others indicating one-half and one-third of this volume.

The test-glass is filled with the wine up to *a*, this is then poured into the flask, which, having been connected with the worm, the distillation is commenced. The liquid which distils over is a mixture of alcohol and water; for ordinary wines, such as clarets and hocks, about one-third is distilled over, and for wines richer in spirit, such as sherries and ports, one-half must be distilled; experiment has shown that under these circumstances all the alcohol passes over in the distillate. The measure is then filled up with

distilled water to *a* ; this gives the mixture of alcohol and water of the same volume as the wine taken, free from all solid matters, such as sugar, colouring matter, and acid, but containing all the alcohol. The specific gravity of this distillate is then taken by means of an alcoholometer (129), and the number thus obtained corresponds to a certain strength of alcohol as indicated by the tables.

368. **Safety tube.**—In preparing gases and collecting them over mercury or water, it occasionally happens that these liquids rush back into the generating vessel, and destroy the operation. This arises from an excess of atmospheric pressure over the tension in the vessel. If a gas, sulphurous acid, for example, be generated in the flask *m* (fig. 298), and be passed into water in the vessel *A*, as long as the gas is given off freely, its tension exceeds the atmospheric pressure and the weight of the column of water, *on*, so that the water in the vessel cannot rise in the tube, and absorption is impossible. But if the tension decreases either through the flask becoming cooled, or the gas being disengaged too slowly, the external pressure prevails, and when it exceeds the internal tension by more than the weight of the column of water *co*, the water rises into the flask and the operation is spoiled. This accident is prevented by means of *safety tubes*.



Fig. 298.

These are tubes which prevent absorption by allowing air to enter in proportion as the internal tension decreases. The simplest is a tube *C*, fig. 299,



Fig. 299.



Fig. 300.

passing through the cork which closes the flask *M*, in which the gas is generated, and dipping in the liquid. When the tension of the gas diminishes in *M*, the atmospheric pressure on the water in the bath *E* causes it to rise to a certain height in the tube *DA* ; but this pressure, acting also on the liquid in the tube *C*, depresses it to the same extent, assuming that this liquid has the same density as the water in *E*. Now as the distance *or* is less

than the height  $DH$ , air enters by the aperture  $o$ , before the water in the bath can rise to  $A$ , and no absorption takes place.

Fig. 300 represents another kind of safety tube. It has a bulb  $a$ , containing a certain quantity of liquid, as does also  $id$ . When the tension of the gas in the retort  $M$  exceeds the atmospheric pressure, the level in the leg  $id$  rises higher in the bulb  $a$ ; if the gas has the tension of one atmosphere, the level is the same in the tube as in the bulb. Lastly, if the tension of the gas is less than the atmospheric pressure, the level sinks in the leg  $di$ ; and, as care is taken that the height  $ia$  is less than  $bh$ , as soon as the air which enters through  $c$  reaches the curved part  $i$ , it raises the column  $ia$ , and passes into the retort before the water in the cylinder can reach  $b$ ; the tension in the interior is then equal to the exterior pressure, and no absorption takes place.

369. **Liquefaction of gases.**—We have already seen that a saturated vapour, the temperature of which is constant, is liquefied by increasing the pressure, and that, the pressure remaining constant, it is brought into the liquid state by diminishing the temperature.

Unsaturated vapours behave in all respects like gases. And it is natural to suppose that what are ordinarily called *permanent gases* are really unsaturated vapours. For the gaseous form is accidental, and is not inherent in the nature of the substance. At ordinary temperatures sulphurous acid is a gas, while in countries near the poles it is a liquid; in temperate climates ether is a liquid, at a tropical heat it is a gas. And just as unsaturated vapours may be brought to the state of saturation, and then liquefied, by suitably diminishing the temperature or increasing the pressure, so by the same means gases may be liquefied. But as they are mostly very far removed from this state of saturation, great cold and pressure are required. Some of them may indeed be liquefied either by cold or by pressure; for the majority, however, both agencies must be simultaneously employed. Few

gases can resist these combined actions, and probably those which have not yet been liquefied, hydrogen, oxygen, nitrogen, binoxide of nitrogen, and carbonic oxide, would become so if submitted to a sufficient degree of cold and pressure.



Fig. 301.

Faraday was the first to liquefy some of the gases. His method consists in enclosing in a bent glass tube (fig. 301) substances by whose chemical action the gas to be liquefied is produced and then sealing the shorter leg. In proportion as the gas is disengaged its pressure increases, and it ultimately liquefies and collects in the shorter leg, more especially if its condensation is assisted by placing the shorter leg in a freezing mixture. A small manometer may be placed in the apparatus to indicate the pressure.

Cyanogen gas is readily liquefied by heating cyanide of mercury in a bent tube of this description; and carbonic acid by heating bicarbonate of sodium; other gases have been condensed by taking advantage of special reactions, the consideration of which belongs rather to chemistry than to

physics. For example, chloride of silver absorbs about 200 times its volume of ammoniacal gas; when the compound thus formed is placed in a freezing tube and gently heated, while the shorter leg is immersed in a freezing mixture, a quantity of liquid ammoniacal gas speedily collects in the shorter leg.

370. **Apparatus to liquefy and solidify gases.**—Thilorier first constructed an apparatus by which considerable quantities of carbonic acid could be liquefied. Its principle is the same as that used by Faraday in working with glass tubes; the gas is generated in an iron cylinder, and passes through a metal tube into another similar cylinder, where it condenses. The use of this apparatus is not free from danger; many accidents have already happened with it, and it has been superseded by an apparatus constructed by Natterer, of Vienna, which is both convenient and safe.

A perspective view of the apparatus, as modified by M. Bianchi, is represented in fig. 303, and a section on a larger scale in fig. 302. It consists of a wrought iron reservoir A, of something less than a quart capacity, which can resist a pressure of more than 600 atmospheres. A small force-pump is screwed on the lower part of this reservoir. The piston-rod *t* is moved by the crank-rod E, which is worked by the handle M. As the compression of the gas and the friction of the piston produce a considerable disengagement of heat, the reservoir A is surrounded by a copper vessel, in which ice or a freezing mixture is placed. The water arising from the melting of the ice passes by a tube, *m*, into a cylindrical copper case C, which surrounds the force-pump, from whence it escapes through the tube *n*, and the stopcock *o*. The whole arrangement rests on an iron frame, PQ.

The gas to be liquefied is previously collected in air-tight bags, R, from whence it passes into a bottle, V, containing some suitable drying substance; it then passes into the condensing pump through the vulcanised india-rubber tube H. After the apparatus has been worked for some time the reservoir A can be unscrewed from the pump without any escape of the liquid, for it is closed below by a valve S (fig. 302). In order to collect some of the liquid gas the reservoir is inverted, and on turning the stopcock *r*, the liquid escapes by a small tubulure *x*.

When carbonic acid has been liquefied, and is allowed to escape into the air, a portion only of the liquid volatilises, in consequence of the heat absorbed by this evaporation; the rest is so much cooled as to solidify in white flakes like snow or anhydrous phosphoric acid.

Solid carbonic acid evaporates very slowly. By means of an alcohol thermometer its temperature has been found to be about  $-90^{\circ}$ . A small quantity placed on the hand does not produce the sensation of such great cold as might be expected. This arises from the imperfect contact. But if the solid be mixed with ether the cold produced is so intense that when a little is placed on the skin all the effects of a severe burn are produced. A mixture of these two substances solidifies four times its weight of mercury in a few minutes. When a tube containing liquid carbonic acid is placed in this mixture, the liquid becomes solid, and looks like a transparent piece of ice.



The most remarkable liquefaction obtained by this apparatus is that of protoxide of nitrogen. The gas once liquefied only evaporates slowly, and produces a temperature of  $88^{\circ}$  below zero. Mercury placed in it in small quantities instantly solidifies. The same is the case with water; it must be added drop by drop, otherwise, its latent heat being much greater than that of mercury, the heat given up by the water in solidifying would be sufficient to cause an explosion of the protoxide of nitrogen.

Protoxide of nitrogen is readily decomposed by heat, and has the property of supporting the combustion of bodies with almost as much brilliancy

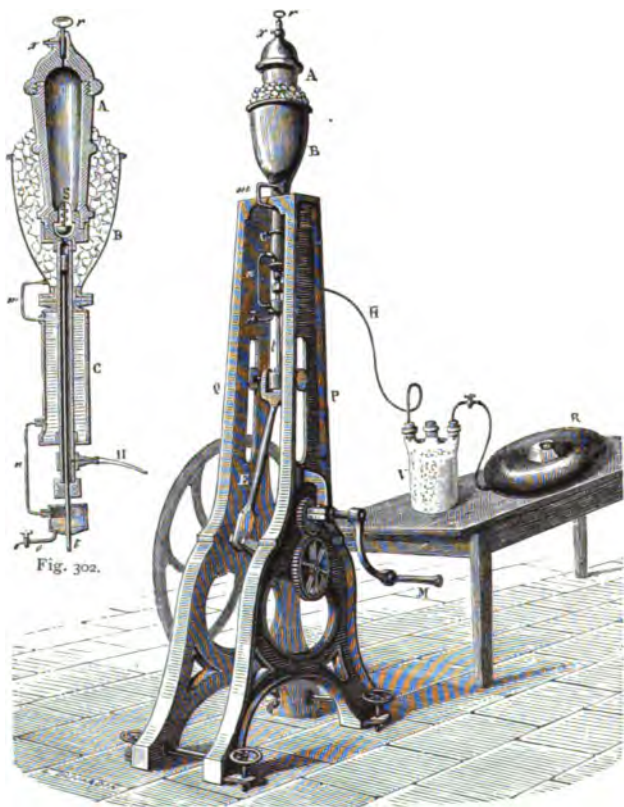

Fig. 303.

as oxygen; and even at low temperatures it preserves this property. When a piece of incandescent charcoal is thrown on liquid protoxide of nitrogen it continues to burn with a brilliant light.

The cold produced by the evaporation of ether (362) has been used by MM. Loir and Drion in the liquefaction of gases. By passing a current of air from a blowpipe bellows through several tubes into a few ounces of ether,

a temperature of  $-34^{\circ}$  C. can be reached in five or six minutes, and may be kept up for fifteen or twenty minutes. By evaporating liquid sulphurous acid in the same manner a great degree of cold,  $-50^{\circ}$  C., is obtained. At this temperature ammoniacal gas may be liquefied. By rapidly evaporating liquid ammonia under the air-pump, in the presence of sulphuric acid, a temperature of  $-87^{\circ}$  is attained, which is found sufficient to liquefy carbonic acid under the ordinary pressure of the atmosphere.

By means of a bath of ether and of solid carbonic acid, and by using very high pressures, Andrews succeeded in reducing air to  $\frac{1}{675}$  of its bulk, oxygen to  $\frac{1}{554}$ , hydrogen to  $\frac{1}{800}$ , carbonic oxide to  $\frac{1}{278}$ , and nitric oxide to  $\frac{1}{680}$  of its original volume, but without producing liquefaction. Hydrogen and carbonic oxide departed less from Boyle's law than oxygen and nitric oxide.

#### MIXTURES OF GASES AND VAPOURS.

371. **Laws of the mixture of gases and vapours.**—Every mixture of a gas and a vapour obeys the following two laws:—

I. *The tension, and, consequently, the quantity of vapour which saturates a given space, are the same for the same temperature, whether this space contains a gas or is a vacuum.*

II. *The tension of the mixture of a gas and a vapour is equal to the sum of the tensions which each would possess if it occupied the same space alone.*

These are known as *Dalton's laws*, from their discoverer, and are demonstrated by the following apparatus, which was invented by Gay-Lussac:—It consists of a glass tube A (fig. 304), to which two stopcocks, *b* and *d*, are cemented. The lower stopcock is provided with a tubulure, which connects the tube A with a tube B of smaller diameter. A scale between the two tubes serves to measure the heights of the mercurial columns in these tubes.

The tube A is filled with mercury, and the stopcocks *b* and *d* are closed. A glass globe M, filled with dry air or any other gas, is screwed on by means of a stopcock in the place of the funnel C. All three stopcocks are then opened, and a little mercury is allowed to escape, which is replaced by the dry air of the globe. The stopcocks are then closed, and as the air in the tube expands on leaving the globe the pressure on it is less than that of the atmosphere. Mercury is accordingly poured into the tube B until it is at the same level in both tubes. The globe is then removed, and replaced by a funnel C, provided with a stopcock *a* of a peculiar construction. It is not perforated, but has a small cavity, as represented in *n*, on the left of the figure. Some of the liquid to be vaporised is poured into C, and the height of the mercury, *k*, having been noted, the stopcock *b* is opened, and *a* turned, so that its cavity becomes filled with liquid; being again turned, the liquid enters the space A and vaporises. The liquid is allowed to fall drop by drop until the air in the tube is saturated, which is the case when the level *k* of the mercury ceases to sink (342).

As the tension of the vapour produced in the space A is added to that of the air already present, the total volume of gas is increased. It may easily be restored to its original volume by pouring mercury into B. When the

mercury in the large tube has been raised to the level  $k$ , there is a difference,  $Bo$ , in the level of the mercury in the two tubes, which obviously represents the tension of the vapour; for as the air has resumed its original volume, its tension has not changed. Now, if a few drops of the same liquid be passed into the vacuum of a barometric tube, a depression exactly equal to  $Bo$  is produced, which proves that, for the same temperature, the tension of a saturated vapour is the same in a gas as in a vacuum; from which it is concluded that at the same temperature the quantity of vapour is also the same.

The second law is likewise proved by this experiment, for, when the mercury has regained its level, the mixture supports the atmospheric pressure on the top of the column B, in addition to the weight of the column of mercury  $Bo$ . But of these two pressures, one represents the tension of the dry air, and the other the tension of the vapour. The second law is, moreover, a necessary consequence of the first.

Experiments can only be made with this apparatus at ordinary temperatures: but M. Regnault, by means of an apparatus which can be used at different temperatures, has investigated the tensions of the vapours of water, ether, bisulphide of carbon, and benzole, both *in vacuo* and in air. He has found that the tension in air is less than it is *in vacuo*, but the differences are so small as not to invalidate Dalton's law. M. Regnault is even inclined to consider this law as theoretically true, attributing the differences which he observed to the hygroscopic properties of the sides of the tube.



Fig. 304.

**372. Problems on mixtures of gases and vapours.**—i. A volume of dry air  $V$ , at the pressure  $H$ , being given, what will be its volume  $V'$ , when it is saturated with vapour, the temperature and the pressure remaining the same?

If  $F$  be the elastic force of the vapour which saturates the air, the latter, in the mixture, only supports a pressure equal to  $H - F$  (371). But by Boyle's law the volumes  $V$  and  $V'$  are inversely as their pressures, consequently

$$\frac{V'}{V} = \frac{H}{H - F}, \text{ whence } V' = \frac{VH}{H - F}.$$

ii. Let  $V$  be a given volume of saturated air at the pressure  $H$ , and the temperature  $t$ ; what will be its volume  $V'$ , also saturated, at the pressure  $H'$ , and the temperature  $t'$ ?

If  $f$  be the maximum tension of aqueous vapour at  $t^\circ$ , and  $f'$  its maximum tension at  $t'^\circ$ , the air alone in each of the mixtures  $V$  and  $V'$  will be respec-

tively under the pressures  $H-f$  and  $H'-f'$ ; consequently, assuming first that the temperature is constant, we obtain

$$\frac{V'}{V} = \frac{H-f}{H'-f'}$$

But as the volumes  $V'$  and  $V$  of air, at the temperatures  $t'$  and  $t$ , are in the ratio of  $1+at'$  to  $1+at$ ,  $a$  being the coefficient of the expansion of air, the equation becomes

$$\frac{V'}{V} = \frac{H-f}{H'-f'} \times \frac{1+at'}{1+at}$$

iii. What is the weight  $P$  of a volume of air  $V$ , saturated with aqueous vapour at the temperature  $t$  and pressure  $H$ ?

If we call  $F$  the maximum tension of the vapour at  $t^\circ$ , the tension of the air alone will be  $H-F$ , and the problem reduces itself to finding: 1st, the weight of  $V$  cubic inches of dry air at  $t$ , and under the pressure  $H-F$ ; and 2nd, the weight of  $V$  cubic inches of saturated vapour at  $t^\circ$  under the pressure  $F$ .

To solve the first part of the problem, we know that a cubic inch of dry air at  $0^\circ$  and the pressure 760 millimetres weighs 0.31 grains, and that at  $t^\circ$ , and the pressure  $H-F$ , it weighs  $\frac{0.31(H-F)}{(1+at)760}$  (321), consequently  $V$  cubic inches of dry air weigh

$$\frac{0.31(H-F)V}{(1+at)760} \dots \dots \dots (1)$$

To obtain the weight of the vapour, the weight of the same volume of dry air at the same temperature and pressure must be sought, and this is to be multiplied by the relative density of the vapour. Now as  $V$  cubic inches of dry air at  $t^\circ$ , and the pressure  $F$ , weigh  $\frac{0.31 \times VF}{(1+at)760}$ ,  $V$  cubic inches of aqueous vapour, whose density is  $\frac{5}{8}$  of that of air (375), weigh

$$\frac{0.31 \times VF}{(1+at)760} \times \frac{5}{8} \dots \dots \dots (2)$$

and as the weight  $P$  is equal to the sum of the weights (1) and (2) we have

$$P = \frac{0.31 \times V(H-F)}{(1+at)760} + \frac{0.31 \times VF}{(1+at)760} \times \frac{5}{8} = \frac{0.31 \times VF}{(1+at)760} (H - \frac{3}{8}F).$$

SPHEROIDAL CONDITION.

373. **Leidenfrost's phenomenon.**—**Boutigny's experiments.**—When liquids are thrown upon incandescent metal surfaces they present remarkable phenomena, which were first observed by Leidenfrost a century ago, and have been named after their discoverer. They have since then been studied by other physicists, and more especially by M. Boutigny, to whom our present knowledge of the subject is mainly due.

When a tolerably thick silver or platinum dish is heated to redness, and a little water, previously warmed, is dropped into the dish by means of a pipette, the liquid does not spread itself out on the dish, and does not moisten it, as

it would at the ordinary temperature, but assumes the form of a flattened globule, which fact M. Boutigny expresses by saying that it has passed into the *spheroidal state*. It rotates rapidly round on the bottom of the dish, taking sometimes the form of a star, and not only does it not boil, but its evaporation is only about one-fiftieth as rapid as if it boiled. As the dish cools, a point is reached at which it is not hot enough to keep the water in the spheroidal state; it is accordingly moistened by the liquid, and a violent ebullition suddenly ensues.

All volatile liquids can assume the spheroidal condition; the lowest temperature at which it can be produced varies with each liquid, and is more elevated the higher the boiling point of the liquid. For water, the dish must have at least a temperature of  $200^{\circ}$ ; for alcohol,  $134^{\circ}$ ; and for ether,  $61^{\circ}$ .

The temperature of a liquid in the spheroidal state is always below its boiling point. This temperature has been measured by M. Boutigny by means of a very delicate thermometer; but his method is not free from objections, and it is probable that the temperatures he obtained were too high. He found that of water to be  $95^{\circ}$ ; alcohol,  $75^{\circ}$ ; ether,  $34^{\circ}$ ; and liquid sulphurous acid,  $-11^{\circ}$ . But the temperature of the vapour which is disengaged appears to be as high as that of the vessel itself.

This property of liquids in the spheroidal state remaining below their boiling point has been applied by M. Boutigny in a remarkable experiment, that of freezing water in a red-hot crucible. He heated a platinum dish to bright redness, and placed a small quantity of liquid sulphurous acid in it. It immediately assumed the spheroidal condition, and its evaporation was remarkably slow. Its temperature, as has been stated, was about  $-11^{\circ}$ , and when a small quantity of water was added it immediately solidified, and a small piece of ice could be thrown out of the red-hot crucible. In a similar manner Faraday, by means of a mixture of solid carbonic acid and ether, succeeded in freezing mercury in a red-hot crucible.

In the spheroidal state the liquid is not in contact with the vessel. M. Boutigny proved this by heating a silver plate placed in a horizontal position, and dropping on it a little dark-coloured water. The liquid assumed the spheroidal condition, and the flame of a candle placed at some distance could be distinctly seen between the drop and the plate. If a plate perforated by several fine holes be heated, a liquid will assume the spheroidal state when projected upon it. This is also the case with a flat helix of platinum wire pressed into a slightly concave shape. An experiment of another class, due to Prof. Church, also illustrates the same fact. A polished silver dish is made red-hot, and a few drops of a solution of sulphide of sodium are projected on it. The liquid passes into the spheroidal condition, and the silver undergoes no alteration. But if the dish is allowed to cool, the liquid instantly moistens it, producing a dark spot, due to the formation of sulphide of silver. In like manner nitric acid assumes the spheroidal state when projected on a heated silver plate, and does not attack the metal so long as the plate remains hot.

An analogous phenomenon is observed when potassium is placed on water. Hydrogen is liberated, and burns with a yellow flame; hydrate of potassium, which is formed at the same time, floats on the surface without

touching it, owing to its high temperature. In a short time it cools down, and the globule coming in contact with water bursts with an explosion.

Similarly, liquids may be made to roll upon liquids, and solid bodies which vaporise without becoming liquid also assume a condition analogous to the spheroidal state of liquids when they are placed on a surface whose temperature is sufficiently high to vaporise them rapidly. This is seen when a piece of carbonate of ammonium is placed in a red-hot platinum crucible.

The phenomena of the spheroidal state seem to prove that the liquid globule rests upon a sort of cushion of its own vapour, produced by the heat radiated from the hot surface against its under side. As fast as this vapour escapes from under the globule, its place is supplied by a fresh quantity formed in the same way, so that the globule is constantly buoyed up by it, and does not come in actual contact with the heated surface. When, however, the temperature of the latter falls, the formation of vapour at the under surface becomes less and less rapid, until at length it is not sufficient to prevent the globule touching the hot metal or liquid on which it rests. As soon as contact occurs heat is rapidly imparted to the globule, it enters into ebullition, and quickly boils away.

These experiments on the spheroidal state explain the fact that the hand may be dipped into melted lead, or even melted iron, without injury. It is necessary that the liquid metal be heated greatly above its solidifying point. Usually the natural moisture of the hand is sufficient, but it is better to wipe it with a damp cloth. In consequence of the great heat the hand becomes covered with a layer of spheroidal fluid, which prevents the contact of the metal with the hand. Radiant heat alone operates, and this is principally expended in forming aqueous vapour on the surface of the hand. If the hand is immersed in boiling water, the water adheres to the flesh, and consequently a scald is produced.

The tales of ordeals by fire during the middle ages, of men who could run barefooted over red-hot iron without being injured, are possibly true in some cases, and would find an explanation in the preceding phenomena.

#### DENSITY OF VAPOURS.

**374. Gay-Lussac's method.**—The *density of a vapour* is the relation between the weight of a given volume of this vapour and of that of the same volume of air at the same temperature and pressure.

Two methods principally are used in determining the density of vapours: Gay-Lussac's, which serves for liquids that boil at about  $100^{\circ}$ , and Dumas', which can be used up to  $350^{\circ}$ .

Fig. 305 represents the apparatus used by Gay-Lussac. It consists of an iron vessel containing mercury, in which there is a glass cylinder, M. This is filled with water or oil, and the temperature is indicated by the thermometer, T. In the interior of the cylinder is a graduated glass jar, C, which, at first, is filled with mercury.

The liquid whose vapour density is to be determined is placed in a small glass bulb, A, represented on the left of the figure. The bulb is then sealed and weighed; the weight of the liquid taken is obviously the weight of the bulb when filled, minus its weight while empty. The bulb is then introduced

into the jar C, and the liquid in M gradually heated somewhat higher than the boiling point of the liquid in the bulb. In consequence of the expansion of this liquid the bulb breaks, and the liquid becoming converted into vapour the mercury is depressed, as represented in the figure.

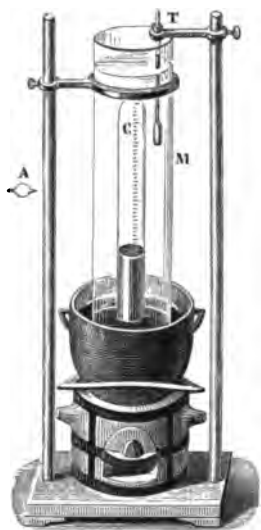

Fig. 305.

The bulb must be so small that all the liquid in it is vaporised. The volume of the vapour is given by the graduation on the jar. Its temperature is indicated by the thermometer T, and the pressure is shown by the difference between the height of the barometer at the time of the observation, and the height of the column of mercury in the gas jar. It is only necessary then to calculate the weight of a volume of air equal to that of the vapour under the same conditions of temperature and pressure. The quotient, obtained by dividing the weight of the vapour by that of the air, gives the required density of the vapour.

Let  $\phi$  be the weight of the vapour in grains,  $v$  its volume in cubic inches, and  $t$  its temperature; if  $H$  be the height of the barometer, and  $h$  that of the mercury in the gas jar, the pressure on the vapour will be  $H - h$ .

It is required to find the weight  $\phi'$  of a volume of air  $v$ , at the temperature  $t$ , and under a pressure  $H - h$ . At zero, under the pressure 760 millimetres, a cubic inch of air weighs 0.31 grain; consequently, under the same conditions,  $v$  cubic inches will weigh 0.31  $v$  grains. And therefore the weight of  $v$  cubic inches of air, at  $t^\circ$  and the pressure 760 millimetres, is

$$\frac{0.31v}{1 + at} \text{ grain [321, prob. ii.]}$$

As the weight of a volume of air is proportional to the pressure, the above weight may be reduced to the pressure  $H - h$  by multiplying by  $\frac{H - h}{760}$  which gives

$$\frac{0.31 v (H - h)}{(1 + at) 760}$$

for the weight  $\phi'$  of the volume of air  $v$ , under the pressure  $H - h$  and at  $t^\circ$ . Consequently, for the desired density we have

$$D = \frac{\phi}{\phi'} = \frac{\phi (1 + at) 760}{0.31 v (H - h)}$$

375. **Hofmann's method.**—Hofmann has materially improved the method of Gay-Lussac by having the mercury tube in which the vapours are produced about a metre in length; it is, in fact, a barometer, and the vapour is formed in the Torricellian vacuum. This tube is surrounded by another glass tube so arranged that water, amylic alcohol, or aniline, or indeed any substance with a constant boiling point, may be distilled through it. In this

way more constancy in the temperatures is ensured than with the use of a mercury bath. The liquid is contained in very minute stoppered tubes holding from 20 to 100 milligrammes of water; the stoppers come out in the vacuum, and the vessels can be used over and over again.

As under the above conditions the liquid vaporises into a vacuum, the vapour is formed under a very much lower pressure than that of the atmosphere, and therefore, at a temperature much below its ordinary boiling point. Thus, the vapour density of a body which only boils at a temperature of  $150^{\circ}$  can be determined at the temperature of boiling water. This is of great use in the case of those bodies which decompose at the boiling point under ordinary pressure.

376. **Dumas' method.**—The method just described cannot be applied to liquids whose boiling point exceeds  $150^{\circ}$  or  $160^{\circ}$ . In order to raise the oil in the cylinder to this temperature it would be necessary to heat the mercury to such a degree that the mercurial vapours would be dangerous to the operator. And, moreover, the tension of the mercurial vapours in the graduated jar would increase the tension of the vapour of the liquid, and so far vitiate the result.

The following method, devised by M. Dumas, can be used up to the temperature at which glass begins to soften; that is, about  $400^{\circ}$ . A glass globe is used with the neck drawn out to a fine point (fig. 306). The globe, having been dried externally and internally, is weighed, the temperature  $t$  and barometric height  $h$  being noted. This weight  $W$  is the weight of the glass  $G$  in addition to  $\phi$ , the weight of the air it contains. The globe is then gently warmed and its point immersed in the liquid whose vapour density is to be determined: on cooling, the air contracts, and a quantity of liquid enters the globe. The globe is then immersed in a bath, either of oil or fusible metal, according to the temperature to which it is to be raised. In order to keep the globe in a vertical position a metal support, on which a movable rod slides, is fixed on the side of the vessel. This rod has two rings, between which the globe is placed, as shown in the figure. There is another rod, to which a weight thermometer,  $D$ , is attached.



Fig. 306.

The globe and thermometer having been immersed in the bath, the latter is heated until slightly above the boiling point of the liquid in the globe. The vapour which passes out by the point expels all the air in the interior. When the jet of vapour ceases, which is the case when all the liquid has been converted into vapour, the point of the globe is hermetically sealed, the temperature of the bath  $t'$ , and the barometric height  $h'$ , being noted. When the globe is cooled, it is carefully cleaned and again weighed. This weight,  $W'$ , is that of the glass,  $G$ , plus  $\phi'$ , the weight of the vapour which fills the globe at the temperature  $t'$ , and pressure  $h'$ , or  $W' = G + \phi'$ . To obtain the weight of the glass alone, the weight  $\phi$  of air must be known, which is



determined in the following manner: The point of the globe is placed under mercury and the extremity broken off with a small pair of pincers: the vapour being condensed, a vacuum is produced, and mercury rushes up, completely filling the globe, if, in the experiment, all the air has been completely expelled. The mercury is then poured into a carefully graduated measure, which gives the volume of the globe. From this result, the volume of the globe at the temperature  $t'$  may be easily calculated, and consequently the volume of the vapour. From this determination of the volume of the globe the weight  $p$  of the air at the temperature  $t$  and pressure  $h$  is readily calculated, and this result subtracted from  $W$  gives  $G$ , the weight of the glass. Now the weight of the vapour  $p'$  is  $W - G$ . We now know the weight  $p'$  of a given volume of vapour at the temperature  $t'$  and pressure  $h'$ , and it is only necessary to calculate the weight  $p''$  of the same volume of air under the same conditions, which is easily accomplished. The quotient  $\frac{p'}{p''}$  is the required density of the vapour.

*Densities of Vapours.*

Air . . . . .	1'0000	Vapour of phosphorus . . .	4'3356
Vapour of water . . . . .	0'6235	„ turpentine . . . . .	5'0130
„ alcohol . . . . .	1'6138	„ sulphur . . . . .	6'6542
„ ether . . . . .	2'5860	„ mercury . . . . .	6'9760
„ bisulphide of carbon	2'6447	„ iodine . . . . .	8'7160

The density of aqueous vapour, when a space is saturated with it, is at all temperatures  $\frac{5}{8}$ , or, more accurately, 0'6225, of the density of air at the same temperature and pressure.

**377. Deville and Troost's method.**—Deville and Troost have modified Dumas' method so that it can be used for determining the vapour density of liquids with very high boiling points. The globe is heated in an iron cylinder in the vapour of mercury or of sulphur, the temperatures of which are constant respectively at 350° and 440°. In other respects the determination is the same as in Dumas' method.

For determinations at higher temperatures, Deville and Troost have employed the vapour of zinc, the temperature of which is 1040°. As glass vessels are softened by this heat, they use porcelain globes with finely drawn-out necks, which are sealed by means of the oxyhydrogen flame.

**378. Relation between the volume of a liquid and that of its vapour.**—The density of vapour being known, we can readily calculate the ratio between the volume of a vapour in the saturated state at a given temperature, and that of its liquid at zero. We may take, as an example, the relation between water at zero and steam at 100°.

The ratio between the weights of equal volumes of air at zero, and the normal barometric pressure, and of water under the same circumstances, is as 1 : 773. But from what has been already said (321), the density of air at zero is to its density at 100° as  $1 + at$  : 1. Hence the ratio between the weights of equal volumes of air at 100° and water at 0° is

$$1 + 0'003665 \times 100 : 773, \text{ or } 0'73178 : 773.$$

Now from the above table the density of steam at 100° C., and the

normal pressure, compared with that of air under the same circumstances, is as 0·6225 : 1. Hence the ratio between the weights of equal volumes of steam at 100°, and water at 0°, is

$$0\cdot73178 \times 0\cdot6225 : 773, \text{ or } 0\cdot4555 : 773 \text{ or } 1 : 1698.$$

Therefore, as the volumes of bodies are inversely as their densities, one volume of water at zero expands into 1698 volumes of steam at 100° C. The practical rule that a cubic inch of water yields a cubic foot of steam, though not quite accurate, expresses the relation in a convenient form.

## CHAPTER VI.

### HYGROMETRY.

**379. Object of hygrometry.**—The object of *hygrometry* is to determine the quantity of aqueous vapour contained in a given volume of air. This quantity is very variable; but the atmosphere is seldom or never completely saturated with vapour, even in our climate. Nor is it ever completely dry; for if *hygrometric substances*, that is to say, substances with a great affinity for water, such as chloride of calcium, sulphuric acid, etc., be at any time exposed to the air, they absorb aqueous vapour.

**380. Hygrometric state.**—As in general the air is never saturated, the ratio of the quantity of aqueous vapour actually present in the atmosphere to that which it would contain if it were saturated, the temperature remaining the same, is called the *hygrometric state*, or *degree of saturation*.

We say the 'air is dry' when water rapidly evaporates and moist objects dry rapidly; and the 'air is moist' when they do not dry rapidly, and when the least lowering in temperature brings about deposits of moisture. The air is dry or moist, according as it is more or less distant from its point of saturation. Our judgment is, in this respect, independent of the absolute quantity of moisture in the air. Thus, if in summer, at a temperature of 25° C., we find that each cubic metre of air contains 13 grammes of vapour, we say it is very dry, for, at this temperature, it could contain 22·5 grammes. If, on the other hand, in winter we find that the same volume contains 6 grammes, we call it moist, for it is nearly saturated with vapour, and the slightest diminution of temperature produces a deposit. When a room is warmed, the quantity of moisture is not diminished, but the humidity of the air is lessened, because its point of saturation is raised. The air may thus become so dry as to be injurious to the health, and it is hence usual to place vessels of water on the stoves used for heating.

As Boyle's law applies to nonsaturated vapours as well as to gases (342), it follows that, with the same temperature and volume, the weight of vapour in a nonsaturated space increases with the pressure and therefore with the tension of the vapour itself. Instead, therefore, of the ratio of the quantities of vapour, that of the corresponding tensions may be substituted, and it may be said that the hygrometric state is *the ratio of the tension of the aqueous vapour which the air actually contains, to the tension of the vapour which it would contain at the same temperature if it were saturated.*

If  $f$  is the actual tension of aqueous vapour in the air, and  $F$  that of saturated vapour at the same temperature, and  $E$  the hygrometric state, we have  $E = \frac{f}{F}$ ; whence  $f = F \times E$ .

As a consequence of this second definition, it is important to notice that, the temperature having varied, the air may contain the same quantity of vapour and yet not have the same hygrometric state. For, when the temperature rises, the tension of the vapour which the air would contain if saturated increases more rapidly than the tension of the vapour actually present in the atmosphere, and hence the ratio between the two forces, that is to say, the hygrometric state becomes smaller.

It will presently be explained (389) how the weight of the vapour contained in a given volume of air may be deduced from the hygrometric state.

381. **Different kinds of hygrometers.**—*Hygrometers* are instruments for measuring the hygrometric state of the air. There are numerous varieties of them—chemical hygrometers, condensing hygrometers, and psychrometers.

382. **Chemical hygrometer.**—The method of the chemical hygrometer consists in passing a known volume of air over a substance which readily absorbs moisture—chloride of calcium, for instance. The substance having been weighed before the passage of air, and then afterwards, the increase in weight represents the amount of aqueous vapour present in the air. By means of the apparatus represented in fig. 307, it is possible to examine any

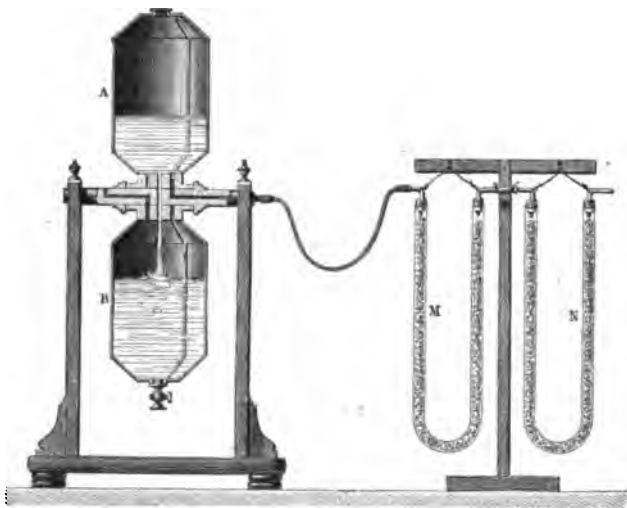

Fig. 307.

given volume. Two brass reservoirs, A and B, of the same size and construction, act alternately as aspirators, by being fixed to the same axis, about which they can turn. They are connected by a central tubulure, and by

means of two tubulures in the axis the lower reservoir is always in connection with the atmosphere, while the upper one, by means of a caoutchouc tube, is connected with two tubes M and N, filled either with chloride of calcium, or with pumice-stone impregnated with sulphuric acid. The first absorbs the vapour in the air drawn through, while the other, M, stops any vapour which might diffuse from the reservoirs to the tube N.

The lower reservoir being full of water, and the upper one of air, the apparatus is inverted so that the liquid flows slowly from A to B. A vacuum being formed in A, air enters by the tubes NM, in the first of which all the vapour is absorbed. When all the water has run into B it is turned; the same flow recommences, and the same volume of air is drawn through the tube N. Thus, if each reservoir holds a gallon, for example, and the apparatus has been turned five times, 6 gallons of air have traversed the tube N, and have been dried. If then, before the experiment, the tube with its contents has been weighed, the increase in weight gives the weight of aqueous vapour present in 6 gallons of air at the time of the experiment.

**383. Condensing hygrometers.**—When a body gradually cools in a moist atmosphere, as, for instance, when a lump of ice is placed in water contained in a polished metal vessel, the layer of air in immediate contact with it cools also, and a point is ultimately reached at which the vapour present is just sufficient to saturate the air; the least diminution of temperature then causes a precipitation of moisture on the vessel in the form of dew. When the temperature rises again, the dew disappears. The mean of these two temperatures is taken as the *dew point*, and the object of condensing hygrometers is to observe this point. Daniell's and Regnault's hygrometers belong to this class.

**384. Daniell's hygrometer.**— This consists of two glass bulbs at the extremities of a glass tube bent twice (fig. 308). The bulb A is two-thirds full of ether, and a very delicate thermometer plunges in it; the rest of the space contains nothing but the vapour of ether, the ether having been boiled before the bulb B was sealed. The bulb B is covered with muslin and ether is dropped upon it. The ether in evaporating cools the bulb, and the vapour contained in it is condensed. The internal tension being thus diminished, the ether in A forms vapours which condense in the other bulb B. In proportion as the liquid distils from the lower to the upper bulb, the ether in A becomes cooler, and ultimately the temperature of the air in immediate contact with A sinks to that point at which its vapour is more than sufficient to saturate it, and it is, accordingly, deposited on the outside as a ring of dew corresponding to the surface of the ether. The temperature

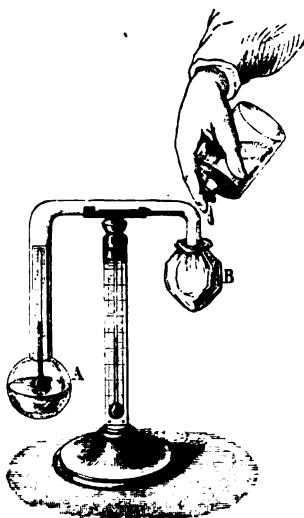

Fig. 303.

of this point is noted by means of the thermometer in the inside. The addition of ether to the bulb B is then discontinued, the temperature of A rises, and the temperature at which the dew disappears is noted. In order to render the deposition of dew more perceptible, the bulb A is made of black glass.

These two points having been determined, their mean is taken as that of the dew point. The temperature of the air at the time of the experiment is indicated by the thermometer on the stem. The tension  $f$ , corresponding to the temperature of the dew point, is then found in the table of tensions (347). This tension is exactly that of the vapour present in the air at the time of the experiment. The tension  $F$  of vapour saturated at the temperature of the atmosphere is found by means of the same table; the quotient obtained by dividing  $f$  by  $F$  represents the hygrometric state of the air (380). For instance, the temperature of the air being  $15^{\circ}$ , suppose the dew point is  $5^{\circ}$ . From the table the corresponding tensions are  $f=6.534$  millimetres, and  $F=12.699$  millimetres, which gives  $0.514$  for the ratio of  $f$  to  $F$ , or the hygrometric state.

There are many sources of error in Daniell's hygrometer. The principal are: 1st, that as the evaporation in the bulb A only cools the liquid on the surface, the thermometer dipping on it does not exactly give the dew point; 2nd, that the observer standing near the instrument modifies the hygrometric state of the surrounding air, as well as its temperature; the cold ether vapour too flowing from the upper bulb may cause inaccuracy.

385. **Regnault's hygrometer.**—Regnault's hygrometer is free from the sources of error incidental to the use of Daniell's. It consists of two very thin polished silver thimbles 1.75 inch in height, and 0.75 inch in diameter (fig. 309). In these are fixed two glass tubes, D and E, in each of which is a thermometer. A bent tube, A, open at both ends, passes through the cork of the tube D, and reaches nearly to the bottom of the thimble. There is a tubulure on the side of D, fitting in a brass tube which forms a support for the apparatus. The end of this tube is connected with an aspirator G. The tube E is not connected with the aspirator; its thermometer simply indicates the temperature of the atmosphere.

The tube D is then half filled with ether, and the stopcock of the aspirator opened. The water contained in it runs out, and just as much air enters through the tube A, bubbling through the ether, and causing it to evaporate. This evaporation produces a diminution of temperature, so that dew is deposited on the silver just as on the bulb in Daniell's hygrometer: the thermometer T is then instantly to be read, and the stream from the aspirator stopped. The dew will soon disappear again, and the thermometer T is again to be read; the mean of the two readings is taken; the thermometer  $t$  gives the corresponding temperature of the air, and hence there are all the elements necessary for calculating the hygrometric state.

As in this instrument all the ether is at the same temperature in consequence of the agitation, and the temperatures are read off at a distance by means of a telescope, the sources of error in Daniell's hygrometer are avoided.

A much simpler form of the apparatus may be constructed out of a common test-tube containing a depth of  $1\frac{1}{2}$  inch of ether. The tube is

provided with a loosely fitting cork in which is a delicate thermometer and a narrow bent tube dipping in the ether. On blowing into the ether, through a caoutchouc tube of considerable length, a diminution of temperature is



Fig. 309.

caused, and dew is ultimately deposited on the glass; after a little practice the whole process can be conducted almost as well as in Regnault's more complete instrument. The temperature of the air is indicated by a detached thermometer.

386. **Psychrometer. Wet bulb hygrometer.**—A moist body evaporates in the air more rapidly in proportion as the air is drier, and in consequence of this evaporation the temperature of the body sinks. The *psychrometer*, or *wet bulb hygrometer*, is based on this principle, the application of which, to this purpose, was first suggested by Leslie. The form usually adopted in this country is due to Mason. It consists of two delicate thermometers placed on a wooden stand (fig. 310). One of the bulbs is covered with muslin, and is kept continually moist by being connected with a reservoir of water by means of a string. Unless the air is saturated with moisture the wet bulb thermometer always indicates a lower temperature than the other, and the difference between the indications of the two thermometers is greater in proportion as the air can take up more moisture. The tension  $e$  of the aqueous vapour in the atmosphere may be calculated from the indications of the thermometer by means of the following empirical formula:—

$$e = e' - 0.00077 (t - t_1)h,$$

in which  $e'$  is the maximum tension corresponding to the temperature of

the wet bulb thermometer,  $h$  is the barometric height, and  $t$  and  $t'$  the respective temperatures of the dry and wet bulb thermometers. If, for example,  $h = 750$  millimetres,  $t = 15^\circ \text{C.}$ ,  $t' = 10^\circ \text{C.}$ ; according to the table of tensions (347),  $e' = 9.165$ , and we have

$$e = 9.165 - 0.00077 \times 5 \times 750 = 6.278.$$

This tension corresponds to a dew point of about  $4.5^\circ \text{C}$ . If the air had been saturated, the tension would have been 12.699, and the air is therefore about half saturated with moisture.

This formula expresses the result with tolerable accuracy, but the above constant 0.00077 requires to be controlled for different positions of the instrument; in small closed rooms it is 0.00128, in large rooms it is 0.00100, and in the open air without wind it is 0.00090: the number 0.00077 is its value in a large room with open windows. Regnault found that the difference in temperature of the two bulbs depends on the rapidity of the current of air; he also found that at a low temperature and in very moist air, the results obtained with the psychrometer differed from those yielded by his hygrometer. It is probable that the indications of the psychrometer are only true for mean and high temperatures, and when the atmosphere is not too moist.

According to Glaisher the temperature of the dew point may be obtained by multiplying the difference between the temperatures of the wet and dry bulb by a constant depending on the temperature of the air at the time of observation, and subtracting the product thus obtained from this last-named temperature. The following are the numbers:—

Dry bulb Temperature F.°	Factor	Dry Bulb Temperature F.°	Factor
Below 24°	8.5	34 to 35	2.8
24 to 25	6.9	35—40	2.5
25—26	6.5	40—45	2.2
26—27	6.1	45—50	2.1
27—28	5.6	50—55	2.0
28—29	5.1	55—60	1.9
29—30	4.6	60—65	1.8
30—31	4.1	65—70	1.8
31—32	3.7	70—75	1.7
32—33	3.3	75—80	1.7
33—34	3.0	80—85	1.6

These are often known as *Glaisher's factors*.

A formula frequently used in this country is that given by Dr. Apjohn. It is

$$F = f - \frac{d}{88} \times \frac{h}{30}, \text{ or } F = f - \frac{d}{96} \times \frac{h}{30}$$

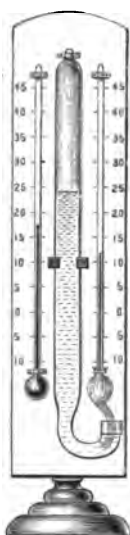

Fig. 310.

in which  $d$  is the difference of the wet and dry bulb thermometers in *Fahrenheit* degrees;  $h$  the barometric height in *inches*;  $f$  the tension of vapour for the temperature of the *wet bulb*, and  $F$  the elastic force of vapour at the dew point, from which the dew point may if necessary be found from the tables. The constant coefficient 88, for the specific heats of air and aqueous vapour, is to be used when the reading of the wet bulb is above  $32^{\circ}$  F., and 96 when it is below.

**387. Hygrometers of absorption.**—These hygrometers are based on the property which organic substances have, of elongating when moist, and of again contracting as they become dry. The most common form is the *hair* or *Saussure's hygrometer*.

It consists of a brass frame (fig. 311), on which is fixed a hair,  $c$ , fastened at its upper extremity in a clamp,  $a$ , provided with a screw,  $d$ . This clamp is moved by a screw  $b$ . The lower part of the hair passes round a pulley,  $o$ , and supports a small weight,  $p$ . On the pulley there is a needle, which moves along a graduated scale. When the hair becomes shorter the needle rises, when it becomes longer the weight  $p$  makes it sink.

The scale is graduated by calling that point zero at which the needle would stand if the air were completely dry, and 100 the point at which it stands in air completely saturated with moisture. The distance between these points is divided into 100 equal degrees.

Regnault has devoted much study in order to render the hair hygrometer scientifically useful, but without much success. And the utmost that can be claimed for it is that it can be used as a *hygroscope*; that is, an instrument which shows approximately whether the air is more or less moist, without giving any indication as to the quantity of moisture present. To this class of hygroscopes belong the chimney ornaments, one of the most common forms of which is that of a small male and female figure, so arranged in reference to a little house, with two doors, that when it is moist the man goes out, and the woman goes in, and *vice versa* when it is fine. They are founded on the property which twisted strings or pieces of catgut possess of untwisting when moist, and of twisting when dry.

As these hygroscopes only change slowly, their indications are always behindhand with the state of the weather; nor are they moreover very exact.

**388. Moisture of the atmosphere.**—The absolute moisture varies with the temperature both in the course of the year and of the day. In summer there is a maximum at eight in the morning and evening, and a minimum at 3 P.M., and at 3 A.M., because the ascending current of air carries the moisture upwards. The *absolute* moisture is greatest in the tropics, where it represents a pressure of  $25^{\text{mm}}$ , while in our latitudes it does not exceed  $10^{\text{mm}}$ . The relative moisture, on the other hand, is at its minimum in the hottest and at its maximum in the coolest part of the day. It varies also in different regions. It is greater in the centre of continents than it is on the sea or the sea coast. That the dryness diminishes with the distance from the sea is shown by the clearer skies of continental regions. In Platowskya in



Fig. 311.



Siberia the air, at a temperature  $24^{\circ}$ , was found to contain a quantity of moisture only sufficient to saturate it at  $-3^{\circ}$ ; the air might therefore have been cooled through  $27^{\circ}$  without any deposit of moisture. In some parts of East Africa, the springs of powder-flasks exposed to the damp snap like twisted quills, paper becomes soft and sloppy by the loss of its glaze, and gunpowder, if not kept hermetically sealed, refuses to ignite. On the other hand, in North America, where the south-west winds blow over large tracts of land, the relative moisture is less than in Europe; evaporation is there far more rapid than in Europe; clothes dry quickly, bread soon becomes hard, newly built houses can be at once inhabited, European pianos soon give way there, while American ones are very durable on this side of the ocean. As regards the animal economy the liquids evaporate more rapidly, by which the circulation and the assimilation is accelerated, and the whole character is more nervous. For evaporation is quicker the drier the air, and the more frequently it is renewed; it is moreover more rapid the higher the temperature, and the less the pressure. This is not in disaccord with the statement that the quantity of vapour which saturates a given space is the same however this be filled with air; a certain space takes up the same weight of vapour whether it is vacuous, or filled with rarefied or dense air; the saturation with vapour takes place the more rapidly the smaller the pressure of the air.

**389. Problem on hygrometry.**—To calculate the weight  $P$  of a volume of moist air  $V$ , the hygrometric state of which is  $E$ , the temperature  $t$ , and the pressure  $H$ , the density of the vapour being  $\frac{5}{8}$  that of air.

From the second law of the mixture of gases and vapours, it will be seen that the moist air is nothing more than a mixture of  $V$  cubic inches of dry air at  $t^{\circ}$ , under the pressure  $H$  minus that of the vapour, and of  $V$  cubic inches of vapour at  $t^{\circ}$  and the tension given by the hygrometric state; these two values must, therefore, be found separately.

The formula  $f = F \times E$  (380) gives the tension  $f$  of the vapour in the air, for  $E$  has been determined, and  $F$  is found from the tables. The tension  $f$  being known, if  $f'$  is the tension of the air,  $f + f' = H$ , from which  $f' = H - f = H - FE$ .

The question consequently resolves itself into calculating the weight of  $V$  cubic inches of dry air at  $t^{\circ}$ , and the pressure  $H - FE$ , and then that of  $V$  cubic inches of aqueous vapour also at  $t^{\circ}$ , but under the pressure  $FE$ .

Now  $V$  cubic inches of dry air under the given conditions weigh  $\frac{0.31 V (H - FE)}{(1 + at) 760}$ , and we readily see from problem III. art. 372, that  $V$  cubic inches of vapour at  $t^{\circ}$ , and the pressure  $FE$ , weigh  $\frac{5}{8} \times \frac{0.31 V FE}{(1 + at) 760}$ . Adding these two weights, and reducing, we get

$$P = \frac{0.31 V (H - \frac{5}{8} FE)}{(1 + at) 076}.$$

If the air were saturated we should have  $E = 1$ , and the formula would thus be changed into that already found for the mixture of gases and saturated vapours (372).

This formula contains, besides the weight P, many variable quantities V, E, H, and *t*, and consequently, by taking successively each of these quantities as unknown, as many different problems might be proposed.

390. **Correction for the loss of weight experienced by bodies weighed in the air.**—It has been seen in speaking of the balance, that the weight which it indicates is only an apparent weight, and is less than the real weight. The latter may be deduced from the former when it is remembered that every body weighed in the air loses a weight equal to that of the displaced air (183) This problem is, however, very complicated, for not only does the weight of the displaced air vary with the temperature, the pressure, and the hygrometric state, but the volume of the body to be weighed, and that of the weights, vary also with the temperature; so that a double correction has to be made; one relative to the *weights*, the other to the body weighed.

*Correction relative to the weights.*—In order to make this correction let P be their weight in air, and Π their real weight *in vacuo*; further, let V be the volume of these weights at *o*°, D the density of the substance of which they are made, and K its coefficient of linear expansion.

The volume V becomes V (1 + 3K*t*) at *t*°, hence this is the volume of air displaced by the *weights*. If μ be the weight of a cubic inch of air at *t*, and the pressure H at the time of weighing, we have

$$P = \Pi - \mu V (1 + 3Kt).$$

From the formula  $P = VD$  (128) V may be replaced by  $\frac{\Pi}{D}$ , and the formula becomes.

$$P = \Pi \left[ 1 - \frac{\mu(1 + 3Kt)}{D} \right] \dots \dots \dots (1)$$

which gives the value, in air, of a *weight* Π, when μ is replaced by its value. But since μ is the weight of a cubic inch of air more or less moist, at the temperature *t* and the pressure H, its value may be calculated by means of the formula in the foregoing paragraph.

*Correction relative to the body weighed.*—Let *p* be the apparent weight of the body to be weighed, π its real weight *in vacuo*, *d* its density, *k* its coefficient of expansion, and *t* its temperature, by the same reasoning as above we have

$$p = \pi \left[ 1 - \frac{\mu(1 + 3kt)}{d} \right] \dots \dots \dots (2)$$

By using the method of double weighing, and of a counterpoise whose apparent weight is *p'*, the real weight π', the density *d'*, and the coefficient *k'*, and assuming that the pressure does not change, which is usually the case, we have again

$$p' = \pi' \left[ 1 - \frac{\mu(1 + 3k't')}{d'} \right] \dots \dots \dots (3)$$

If *a* and *b* are the two arms of the beam, we have in the first weighing  $ap = pb$ ; and in the second  $aP = bP'$ , whence  $p = P$ . Replacing P and *p* by their values deduced from the above equations, we have

$$\pi \left[ 1 - \frac{\mu(1+3kt)}{d} \right] = \pi \left[ 1 - \frac{\mu(1+3Kt)}{D} \right]$$

$$1 - \frac{\mu(1+3Kt)}{D}$$

whence

$$\pi = \frac{\mu(1+3kt)}{d}$$

which solves the problem.

## CHAPTER VII.

### CONDUCTIVITY OF SOLIDS, LIQUIDS, AND GASES.

391. **Transmission of heat.**—When we stand at a little distance from a fire or other source of heat we experience the sensation of warmth. The heat is not transmitted by the intervening air; it passes through it without raising its temperature, for if we place a screen before the fire the sensation ceases to be felt. The heat from the sun reaches us in the same manner. The heat, which, as in this case, is transmitted to a body from the source of heat without affecting the temperature of the intervening medium, is said to be *radiated*.

That heat can be transmitted through a medium without raising its temperature is proved by a remarkable experiment of Prevost in 1811. Water from a spring was allowed to fall in a thin sheet; on one side of this was held a red-hot iron ball, and on the other a delicate thermometer. The temperature of the latter was observed to rise steadily, a result which could not have been due to any heating effect of the water itself, as this was cold, and was continually renewed. It could only have been due to heat which traversed the water without raising its temperature. A similar experiment has been made by a hollow glass lens through which cold water flowed in a constant stream. The sun's rays concentrated by this arrangement ignited a piece of timber placed in the focus.

Heat is transmitted in another way. When the end of a metal bar is heated, a certain increase of temperature is presently observed along the bar. Where the heat is transmitted in the mass of the body itself, as in this case, it is said to be *conducted*. We shall first consider the transmission of heat by conduction.

392. **Conductivity of solids.**—Bodies conduct heat with different degrees of facility. *Good conductors* are those which readily transmit heat, such as are the metals; while *bad conductors*, to which class belong the resins, glass, wood, and more especially liquids and gases, offer a greater or less resistance to the transmission of heat.

In order to compare roughly the conducting power or *conductivity* of different solids, Ingenhaus constructed the apparatus which bears his name and which is represented in fig. 312. It is a metal trough, in which, by means of tubulures and corks, are fixed rods of the same dimensions, but of different materials; for instance, iron, copper, wood, glass. These rods extend to a slight distance in the trough, and the parts outside are coated

with wax, which melts at  $61^{\circ}$ . The box being filled with boiling water, it is observed that the wax melts to a certain distance on the metal rods, while on the others there is no trace of fusion. The conducting power is evidently greater in proportion as the wax has fused to a greater distance. The experiment is sometimes modified by attaching glass balls or marbles to the ends of the rods by means of wax. As the wax melts, the balls drop off, and this in the order of their respective conductivities. The quickness with which melting takes place is, however, only a measure of the conducting power, in case the metals have the same or nearly the same specific heat.



Fig. 312.

M. Despretz has compared the conducting powers of solids by means of the apparatus represented in fig. 313. It is a bar in which small cavities are made at intervals of 4 inches: these cavities contain mercury, and a delicate thermometer is placed in each of them. This bar is exposed at one end to a



Fig. 313.

constant source of heat; the thermometers gradually rise until they indicate fixed temperatures, which are less according as the thermometers are farther from the source of heat. By this method Despretz verified the following law:—*If the distances from the source of heat increase in arithmetical progression, the excess of temperature over that of the surrounding air decreases in geometrical progression.*

This law, however, only prevails in the case of very good conductors, such as gold, platinum, silver, and copper; it is only approximately true for iron, zinc, lead, and tin, and does not apply at all to non-metallic bodies, such as marble, porcelain, etc.

Taking the conducting power of gold at 1000, Despretz has constructed the following table of conductivities:—

Platinum . . . . .	981	Tin . . . . .	304
Silver . . . . .	973	Lead . . . . .	179
Copper . . . . .	897	Marble . . . . .	23
Iron . . . . .	374	Porcelain . . . . .	12
Zinc . . . . .	363	Brick earth . . . . .	11

Wiedemann and Franz have made some valuable investigations on the conductivity of heat in metals. By making cavities in the bars, as in Despretz's method, their form is altered, and the continuity partially destroyed. Wiedemann and Franz have avoided this source of error by measuring the temperature of the bars in different places by applying to them the junction of a thermo-electric couple (400).

The metal bars were made as regular as possible; one of the ends was heated to 100°, the rest of the bar being surrounded by air at a constant temperature. The thermo-electric couple was of small dimensions, in order not to abstract too much heat.

By this method Wiedemann and Franz obtained results which differ considerably from those of Despretz. Representing the conductivity of silver by 100°, they found for the other metals the following numbers:—

Silver . . . . .	100·0	Steel . . . . .	11·6
Copper . . . . .	73·6	Lead . . . . .	8·5
Gold . . . . .	53·2	Platinum . . . . .	8·4
Tin . . . . .	14·5	Rose's alloy . . . . .	2·8
Iron . . . . .	11·9	Bismuth . . . . .	1·8

Organic substances conduct heat badly. De la Rive and de Candolle have shown that woods conduct better in the direction of their fibres than in a transverse direction; and have remarked upon the influence which this feeble conducting power, in a transverse direction, exerts in preserving a tree from sudden changes of temperature, enabling it to resist alike a sudden abstraction of heat from within, and the sudden accession of heat from without. Tyndall has also shown that this tendency is aided by the low conducting power of the bark, which is in all cases less than that of the wood. Cotton, wool, straw, bran, etc. are all bad conductors.

393. **Coefficient of conductivity.**—The numbers given in the foregoing article only express the *relative* conducting powers of the respective substances. Numerous experiments have been made to determine the quantity of heat which passes, for instance, through a plate the two sides of which are kept at a constant difference of temperature. This amount will clearly depend on the area, the thickness, and the specific nature of the plate; on the difference in temperature of the two faces, and on the time. Adopting the centimetre, gramme, and second as units of length, mass, and time, we have for the quantity  $Q$  the formula

$$Q = \frac{K (v_2 - v_1) t A}{d},$$

where  $v_2$  and  $v_1$  are the temperatures of the two faces,  $t$  the time,  $A$  the area, and  $d$  the thickness of the plate, while  $K$  is a constant expressed in gramme degrees (434), the mean values of which are as follows; copper, 66·5; zinc, 18·4; iron, 9·8; German silver, 6·6; and lead, 2·3.

394. **Senarmont's experiment.**—It is only in homogeneous bodies that heat is conducted with equal facility in all directions. If an aperture be made in a circular piece of ordinary glass covered with a thin layer of wax, and a platinum wire ignited by a voltaic current be held through the aperture, the wax will be melted round the hole in a circular form. Senarmont has made, on this principle, a series of experiments on the conductivity of heat in crystals. A plate cut from a crystal of the regular system was covered with wax, and a heated metallic point was held against it. The part melted had a circular form; but when plates of crystals belonging to other systems were investigated in a similar manner, it was found that the form of the isothermal line or line of equal temperature, that is, the limit of the melted part, varied with the different systems and with the position of the axes. In plates of uniaxial crystals cut parallel to the principal axis it was an ellipse, the major axis of which was in the direction of the principal axis. In plates cut perpendicular to the principal axis it was a circle. In biaxial crystals the line was always an ellipse.

395. **Conductivity of liquids.**—The conductivity of liquids is very small, as is seen from the following experiment: A delicate thermoscope B, consisting of two glass bulbs, joined by a tube, *m*, in which there is a small index of coloured liquid, is placed in a large cylindrical glass vessel, D (fig. 314). This vessel is filled with water at the ordinary temperature, and a tin vessel, A, containing oil at a temperature of two or three hundred degrees, is dipped in it. The bulb near the vessel A is only very slightly heated, and the index *m* moves through a very small distance. Other liquids give the same result. That liquids conduct very badly is also demonstrated by a simpler experiment. A long test-tube is half filled with water and some ice so placed in it that it cannot rise to the surface. By inclining the tube and heating the surface of the liquid by means of a spirit lamp, the liquid at the top may be made to boil, while the ice at the bottom remains unmelted.



Fig. 314.

Despretz made a series of experiments with an apparatus analogous to that here described, but he kept the liquid in the vessel, A, at a constant temperature, and arranged a series of thermometers one below the other in the vessel D. In this manner he found that the conductivity of heat in liquids obeys the same laws as in solids, but is much more feeble. For example, the conductivity of water is  $\frac{1}{93}$  that of copper.

Paalzow states that in regard to conducting power the following liquids stand in the order given of their decreasing conductivity for heat: Mercury, water, solution of sulphate of copper, sulphuric acid, solution of sulphate of zinc, solution of common salt.

Guthrie has examined the conductivity of liquids in the following manner. Two hollow brass cones are placed near each other so that the top of one points upwards, that of the other downwards (fig. 315). The distance of the bases, which are of platinum, can be regulated by a micrometer screw. Between the bases the liquid to be examined is introduced by means of a

pipette. The lower cone is fitted with a glass tube which dips in a coloured liquid, and thus constitutes an air thermometer. The base of the upper cone is kept at a constant temperature by means of a current of hot water; it thus warms the liquid, and the base of the lower cone, in consequence of which

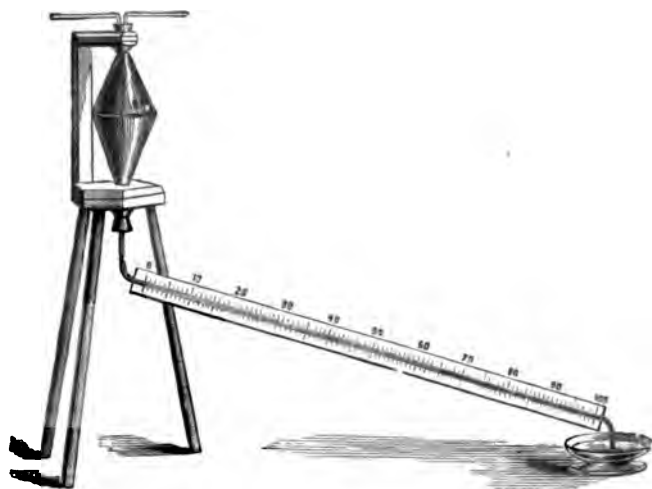

Fig. 315.

the air in the interior is expanded and the column of liquid in the stem depressed.

The bases of the cones were first brought in contact and the depression of the column of liquid was observed. A column of liquid of a given thickness was then interposed and the depression observed after a certain time. The same thicknesses of other liquids were then successively introduced and the corresponding depressions noted. The difference of the depressions was a measure for the resistance which the liquid offered to the passage of heat. The following numbers give the ratios of the resistance of the respective liquids to that of an equal thickness of water :—

Water . . . . .	1.00	Alcohol . . . . .	9.08
Glycerine . . . . .	3.84	Oil of turpentine . . . . .	11.75
Sperm oil . . . . .	3.85	Chloroform . . . . .	12.10

It was also observed that water conducts better the hotter it is; and any salt dissolved increases the conductivity.

396. **Manner in which liquids are heated.**—When a column of liquid is heated at the bottom, ascending and descending currents are produced. It is by these that heat is mainly distributed through the liquid, and not by its conductivity. These currents arise from the expansion of the inferior layers, which, becoming less dense, rise in the liquid, and are replaced by colder and denser layers. They may be made visible by projecting bran or wooden shavings into water, which rise and descend with the currents. The experi-

ment is arranged as shown in fig. 316. The mode in which heat is thus propagated in liquids and in gases is said to be by *convection*.

397. **Conductivity of gases.**—It is a disputed question whether gases have a true conductivity; but certainly when they are restrained in their motion their conductivity is very small. All substances, for instance, between whose particles air remains stationary, offer great resistance to the propagation of heat. This is well seen in straw, eider down, and furs. The propagation of heat in a gaseous mass is effected by means of the ascending and descending currents formed in it, as in the case with liquids.

The following experiment originally devised by Grove is considered to prove that gases have a certain conductivity. In a glass vessel provided with delivery tubes by which any gases can be introduced, or by which it can be exhausted, is a platinum wire which can be heated to redness by a voltaic battery. When the vessel is exhausted the platinum wire is gradually raised to a bright redness; on then allowing air to enter, the luminosity is greatly diminished, and if the vessel be exhausted and then hydrogen admitted, the luminosity quite disappears. This greater chilling of the wire in hydrogen than in air is considered by Magnus to be an effect of conduction; while Tyndall ascribes it to the greater mobility of the particles of hydrogen.

398. **Applications.**—The greater or less conductivity of bodies meets with numerous applications. If a liquid is to be kept warm for a long time, it is placed in a vessel and packed round with non-conducting substances, such as shavings, straw, bruised charcoal. For this purpose water pipes and pumps are wrapped in straw at the approach of frost. The same means are used to hinder a body from becoming heated. Ice is transported in summer by packing it in bran, or folding it in flannel.

Double walls constructed of thick planks having between them any finely divided materials, such as shavings, sawdust, dry leaves, etc., retain heat extremely well; and are likewise advantageous in hot countries, for they prevent its access. Pure silica in the state of rock crystal is a better conductor than lead, but in a state of powder it conducts very badly. If a layer of asbestos is placed on the hand a red-hot iron ball can be held without inconvenience. Red-hot cannon balls can be wheeled to the gun's mouth in wooden barrows partially filled with sand. Lava has been known to flow over a layer of ashes underneath which was a bed of ice, and the non-conducting power of the ashes has prevented the ice from fusion.

The clothes which we wear are not warm in themselves; they only hinder the body from losing heat, in consequence of their spongy texture and the air they enclose. The warmth of bed-covers and of counterpanes is explained in a similar manner. Double windows are frequently used in cold climates to keep a room warm—they do this by the non-conducting layer of air interposed between them. During the night the windows are



Fig. 316.



opened, while during the day they are kept closed. It is for the same reason that two shirts are warmer than one of the same material but of double the thickness. Hence too the warmth of furs, eider-down, etc.

The small conducting power of felt is used in the North of Europe in the construction of the *Norwegian stove*, which consists merely of a wooden box with a thick lining of felt on the inside. In the centre is a cavity in which can be placed a stew-pan provided with a cover. On the top of this is a lid, also made of felt, so that the pan is surrounded by a very badly conducting envelope. Meat, with water and suitable additions, is placed in the pan, and the contents are then raised to boiling. The whole is then enclosed in the box and left to itself; the cooking will go on without fire, and after the lapse of several hours it will be quite finished. The cooling down is very slow, owing to the bad conducting power of the lining; at the end of three hours the temperature is usually not found to have sunk more than from  $10^{\circ}$  to  $15^{\circ}$ .

That water boils more rapidly in a metallic vessel than in one of porcelain of the same thickness; that a burning piece of wood can be held close to the burning part with the naked hand, while a piece of iron heated at one end can only be held at a great distance, are easily explained by reference to their various conductivities.

The sensation of heat or cold which we feel when in contact with certain bodies is materially influenced by their conductivity. If their temperature is lower than ours, they appear colder than they really are, because from their conductivity heat passes away from us. If, on the contrary, their temperature is higher than that of our body, they appear warmer from the heat which they give up at different parts of their mass. Hence it is clear why carpets, for example, are warmer than wooden floors, and why the latter are warmer than stone floors.

---

## CHAPTER VIII.

### RADIATION OF HEAT.

399. **Radiant heat.**—It has been already stated (391) that heat could be transmitted from one body to another without altering the temperature of the intervening medium. If we stand in front of a fire we experience a sensation of warmth which is not due to the temperature of the air, for if a screen be interposed the sensation immediately disappears, which would not be the case if the surrounding air had a high temperature. Hence bodies can send out rays which excite heat, and which penetrate through the air without heating it, as rays of light through transparent bodies. Heat thus propagated is said to be *radiated*; and we shall use the terms *ray of heat*, or *thermal*, or *calorific ray*, in a similar sense to that in which we use the term *ray of light* or *luminous ray*.

We shall find that the property of radiating heat is not confined to luminous bodies, such as a fire or a red-hot ball, but that bodies of all temperatures radiate heat. It will be convenient to make a distinction between *luminous* and *obscure* rays of heat.

400. **Detection and measurement of radiant heat.**—In demonstrating the phenomena of radiant heat, very delicate thermometers are required, and the thermo-electrical multiplier of Melloni is used for this purpose with great advantage; for it not only indicates minute differences of temperature, but it also measures them with accuracy.

This instrument cannot be properly understood without a knowledge of the principles of thermo-electricity, for which Book X. must be consulted. It may, however, be stated here, that when two different metals A and B are soldered together at one end (fig. 317), the free ends being joined by a wire,

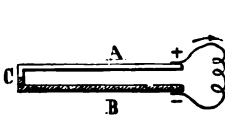

Fig. 317.

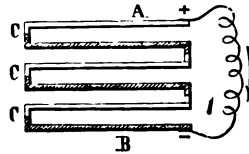

Fig. 318.

when the soldering C is heated, a current of electricity circulates through the system; if, on the contrary, the soldering be cooled, a current is also produced, but it circulates in exactly the opposite direction. This is called a *thermo-electric couple* or *pair*. If a number of such pairs be alternately soldered together, as represented in fig. 318, the intensity of the current produced by heating the ends is increased; or, what amounts to the same thing, a smaller degree of heat will produce the same effect. Such an arrangement of a number of thermo-electric pairs is called a *thermo-electric battery* or *pile*.

Melloni's thermo-multiplier consists of a thermo-electric pile connected with a delicate galvanometer. The thermo-electric pile is constructed of a

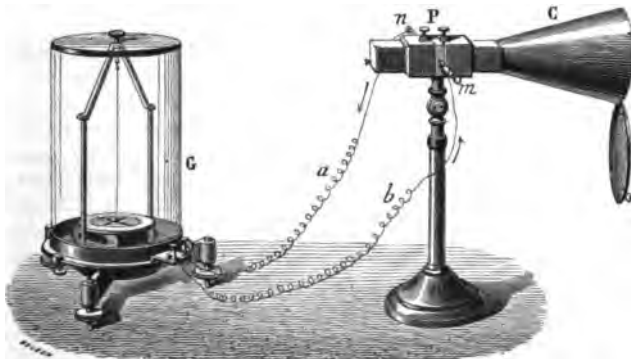

Fig. 319.

number of minute bars of bismuth and antimony soldered together alternately, though kept insulated from each other, and contained in a rectangular box P, fig. 319. The terminal bars are connected with two binding screws m and

$n$ , which in turn are connected with the galvanometer  $G$  by means of the wires  $a$  and  $b$ .

The galvanometer consists of a quantity of fine insulated copper wire coiled round a frame, in the centre of which a delicate magnetic needle is suspended by means of a silk thread. When an electric current is passed through this coil, the needle is deflected through an angle which depends on the intensity of the current. This angle is measured on a dial by an index connected with the needle.

It may then be sufficient to state that the thermo-electric pile being connected with the galvanometer by means of the wires  $a$  and  $b$ , an excess of temperature at one end of the pile causes the needle to be deflected through an angle which depends on the extent of this excess; and similarly if the temperature is depressed below that of the other end, a corresponding deflection is produced in the opposite direction. By arrangements of this kind Melloni was able to measure differences of temperature of  $\frac{1}{5000}$ th of a degree.

The object of the cone  $C$  is to concentrate the thermal rays on the face of the pile.

**401. Laws of radiation.**—The radiation of heat is governed by three laws:—

I. *Radiation takes place in all directions round a body.* If a thermometer be placed in different positions round a heated body, it indicates everywhere a rise in temperature.

II. *In a homogeneous medium, radiation takes place in a right line.* For, if a screen be placed in a right line which joins the source of heat and the thermometer, the latter is not affected.

But in passing obliquely from one medium into another, as from air into a glass, calorific like luminous rays become deviated, an effect known as *refraction*. The laws of this phenomenon are the same for heat as for light, and they will be more fully discussed under the latter subject.

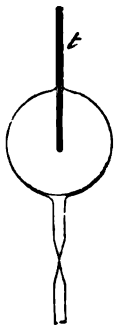

Fig. 320.

III. *Radiant heat is propagated in vacuo as well as in air.* This is demonstrated by the following experiment:—

In the bottom of a glass flask a thermometer is fixed in such a manner that its bulb occupies the centre of the flask (fig. 320). The neck of the flask is carefully narrowed by means of the blowpipe, and then the apparatus having been suitably attached to an air-pump, a vacuum is produced in the interior. This having been done, the tube is sealed at the narrow part. On immersing this apparatus in hot water, or on bringing near it some hot charcoal, the thermometer is at once seen to rise. This could only arise from radiation through the vacuum in the interior, for glass is so bad a conductor that the heat could not travel with this rapidity through the sides of the flask and the stem of the thermometer.

**402. Causes which modify the intensity of radiant heat.**—By the *intensity of radiant heat* is understood the quantity of heat received on the unit of surface. Three causes are found to modify this intensity: the temperature of the source of heat, its distance, and the obliquity of the calorific

rays in reference to the surface which emits them. The laws which regulate these modifications may be thus stated :—

I. *The intensity of radiant heat is proportional to the temperature of the source.*

II. *The intensity is inversely as the square of the distance.*

III. *The intensity is less, the greater the obliquity of the rays with respect to the radiating surface.*

The first law is demonstrated by placing a metal box containing water at  $10^{\circ}$ ,  $20^{\circ}$ , or  $30^{\circ}$  successively at equal distances from the bulb of a differential thermometer. The temperatures indicated by the latter are then found to be in the same ratio as those of the box : for instance, if the temperature of that corresponding to the box at  $10^{\circ}$  be  $2^{\circ}$ , those of others will be  $4^{\circ}$  and  $6^{\circ}$  respectively.

The truth of the second law follows from the geometrical principle that the surface of a sphere increases as the square of its radius. Suppose a hollow sphere  $ab$  (fig. 321) of any given radius, and a source of heat  $C$ , in its centre ; each unit of surface in the interior receives a certain quantity of heat. Now a sphere,  $ef$ , of double the radius will present a surface four times as great : its internal surface contains, therefore, four times as many units of surface, and as the quantity of heat emitted is the same, each unit must receive one-fourth the quantity.

To demonstrate the same law experimentally, a narrow tin plate box is taken (fig. 322), filled with hot water, and coated on one side with lampblack.

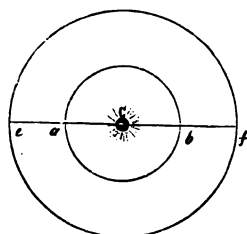

Fig. 321.

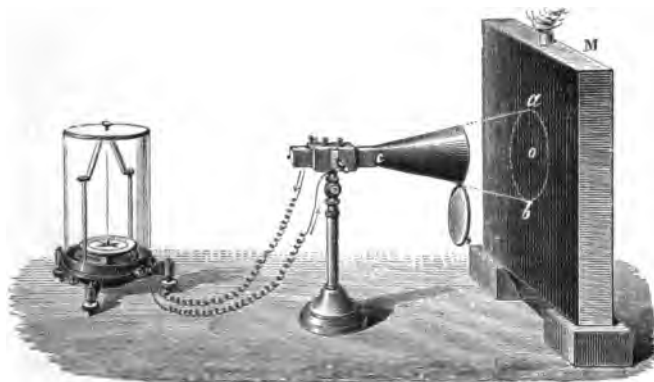

Fig. 322.

The thermo-pile with its conical reflector is placed so that its face is at a certain definite distance,  $co$ , say 9 inches, from this box, and the cover having been lowered, the needle of the galvanometer is observed to be deflected through  $80^{\circ}$ , for example.

If now the pile is removed to a distance,  $CO$  (fig. 323), double that of  $co$ ,

the deflection of the galvanometer remains the same, which shows that the battery receives the same amount of heat; the same is the case if the battery is removed to three or four times the distance. This result, though apparently in opposition to the second law, really confirms it. For at first the battery only receives heat from the circular portion  $ab$  of the side of the box, while, in the second case, the circular portion  $AB$  radiates towards it. But, as the two cones  $ACB$  and  $acb$  are similar, and the height of  $ACB$  is

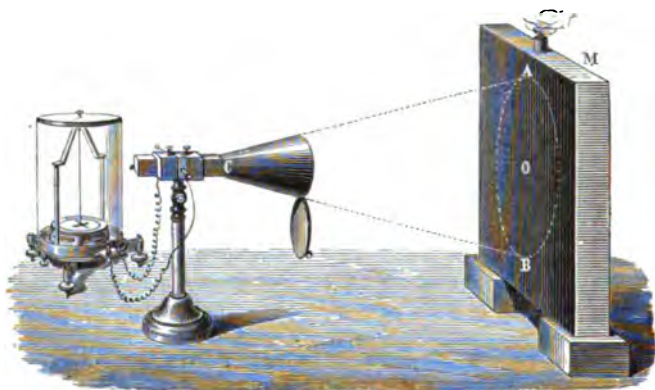

Fig. 323.

double that of  $acb$ , the diameter  $AB$  is double that of  $ab$ , and therefore the area  $AB$  is four times as great as that of  $ab$ , for the areas of circles are proportional to the squares of the radii. But since the radiating surface increases as the square of the distance, while the galvanometer is stationary, the heat received by the battery must be inversely as this same square.

The third law is demonstrated by means of the following experiment, which is a modification of one originally devised by Leslie (fig. 324).  $P$

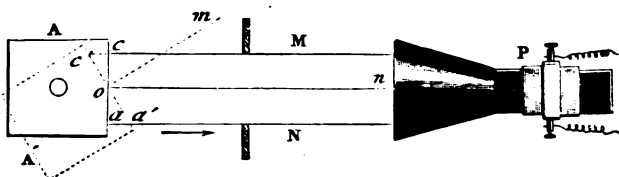

Fig. 324.

represents the thermo-multiplier which is connected with its galvanometer, and  $A$ , a metal cube full of hot water. The cube being first placed in such a position,  $A$ , that its front face,  $ac$ , is vertical, the deflection of the galvanometer is noted. Supposing it amounts to  $45^\circ$ , this represents the radiation from  $ac$ . If this now be turned in the direction represented by  $A'$ , the galvanometer is still found to mark  $45^\circ$ .

The second surface is larger than the first, and it therefore sends more

rays to the mirror. But as the action on the thermometer is no greater than in the first case, it follows that in the second case, where the rays are oblique, the intensity is less than in the first case, where they are perpendicular.

In order to express this in a formula, let  $i$  be the intensity of the rays emitted perpendicularly to the surface, and  $i'$  that of the oblique rays. These intensities are necessarily inversely as the surfaces  $ac$  and  $a'c'$ , for the effect is the same in both cases, and therefore  $i' \times \text{surface } a'c' = i \times \text{surface } ac$ ; hence  $i' = i \frac{\text{surf. } ac}{\text{surf. } a'c'} = i \frac{ac}{a'c'} = i \cos aod'$ ; which signifies that *the intensity of oblique rays is proportional to the cosine of the angle which these rays form with the normal to the surface*; for this angle is equal to the angle  $aod'$ . This law is known as the *law of the cosine*; it is, however, not general; M.M. Desains and De la Provostaye have shown that it is only true within very narrow limits, that is, only with bodies which, like lampblack, are entirely destitute of reflecting power (411).

403. **Mobile equilibrium. Theory of exchanges.**—Prevost of Geneva suggested the following hypothesis in reference to radiant heat, known as Prevost's *theory of exchanges*, which is now universally admitted. All bodies, whatever their temperatures, constantly radiate heat in all directions. If we imagine two bodies at different temperatures placed near one another, the one at a higher temperature will experience a loss of heat, its temperature will sink, because the rays it emits are of greater intensity than those it receives; the colder body, on the contrary, will rise in temperature, because it receives rays of greater intensity than those which it emits. Ultimately the temperature of both bodies becomes the same, but heat is still exchanged between them, only each receives as much as it emits, and the temperature remains constant. This state is called the *mobile equilibrium of temperature*.

404. **Newton's law of cooling.**—A body placed in a vacuum is only cooled or heated by radiation. In the atmosphere it becomes cooled or heated by its contact with the air according as the latter is colder or hotter than the radiating body. In both cases the velocity of cooling or of heating—that is, *the quantity of heat lost or gained in a second*—is greater according as the difference of temperature is greater.

Newton has enunciated the following law in reference to the cooling or heating of a body: *The quantity of heat lost or gained by a body in a second is proportional to the difference between its temperature and that of the surrounding medium.* Dulong and Petit have proved that this law is not so general as Newton supposed, and only applies where the differences of temperature do not exceed  $15^\circ$  to  $20^\circ$ . Beyond that, the quantity of heat lost or gained is greater than that required by this law.

Two consequences follow from Newton's law:—

I. When a body is exposed to a constant source of heat, its temperature does not increase indefinitely, for the quantity which it receives in the same time is always the same; while that which it loses increases with the excess of its temperature over that of the surrounding medium. Consequently a point is reached at which the quantity of heat emitted is equal to that absorbed, and the temperature then remains stationary.

II. Newton's law, as applied to the differential thermometer, shows that

its indications are proportional to the quantities of heat which it receives. If one of the bulbs of a differential thermometer receives rays of heat from a constant source, the instrument exhibits first increasing temperatures, but afterwards becomes stationary. In this case, the quantity of heat which it receives is equal to that which it emits. But the latter is proportional to the excess of the temperature of the bulb above that of the surrounding atmosphere, that is, to the number of degrees indicated by the thermometer; consequently, the temperature indicated by the differential thermometer is proportional to the quantity of heat it receives.

#### REFLECTION OF HEAT.

**405. Laws of reflection.**—When thermal rays fall upon a body they are, speaking generally, divided into two parts, one of which penetrates the body, while the other rebounds as if repelled from the surface like an elastic ball. This is said to be *reflected*.

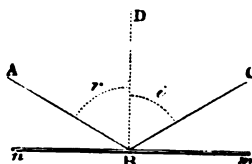

Fig. 325.

If  $mn$  be a plane reflecting surface (fig. 325),  $CB$  an *incident ray*,  $BD$  a line perpendicular to the surface called the *normal*, and  $BA$  the *reflected ray*; the angle  $CBD$  is called the *angle of incidence*, and  $DBA$  the *angle of reflection*.

The reflection of heat, like that of light, is governed by the two following laws :—

- I. *The angle of reflection is equal to the angle of incidence.*
- II. *Both the incident and the reflected ray are in the same plane with the normal to the reflecting surface.*

**406. Experimental demonstration of the laws of reflection of heat.**—This may be effected by means of Melloni's thermo-pile and also by the

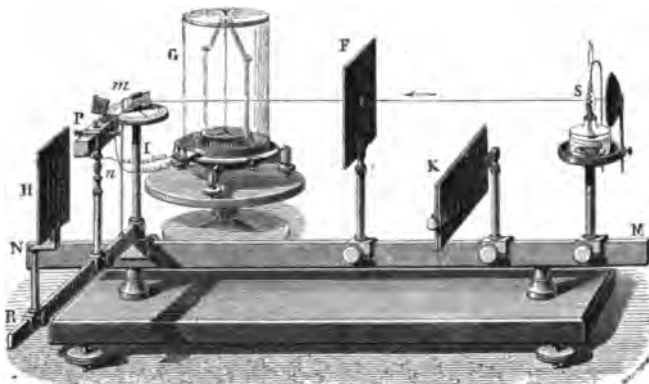

Fig. 326.

conjugate mirrors (408). Figure 326 represents the arrangement adopted in the former case.  $MN$  is a horizontal bar, about a metre in length graduated

in millimetres, on which slide various parts, which can be clamped by means of screws. The source of heat, S, is a platinum spiral, kept at a white heat in a spirit lamp. A screen K, when raised, cuts off the radiation from the source; a second screen, F, with an aperture in the centre, gives the rays a parallel direction. At the other end is an upright rod, I, with a graduated dial, the zero of which is in the direction of MN, and therefore parallel to the pencil Sm. In the centre of the dial is an aperture, in which turns an axis that supports a metallic mirror *m*. About this axis turns an index, R, on which is fixed the thermo-pile, P, in connection with the galvanometer, G. H is a screen, the object of which is to cut off any direct radiation from the source of heat towards the pile. In order not to mask the pile, it is not represented in the position it occupies in the experiment.

By lowering the screen K, a pencil of parallel rays, passing through the aperture F, falls upon the mirror *m*, and is there reflected. If the index R is not in the direction of the reflected pencil, this latter does not impinge on the pile, and the needle of the galvanometer remains stationary; but by slowly turning the index R, a position is found at which the galvanometer attains its greatest deviation, which is the case when the battery receives the reflected pencil perpendicularly to its surface. Reading off then on the dial the position of a small needle perpendicular to the mirror, it is observed that this bisects the angle formed by the incident and the reflected pencil, which demonstrates the first law.

The second law is also proved by the same experiment, for the various pieces of the apparatus are arranged so that the incident and reflected ray are in the same horizontal plane, and therefore at right angles to the reflecting surface, which is vertical.

407. **Reflection from concave mirrors.**—*Concave mirrors or reflectors* are polished spherical or parabolic surfaces of metal or of glass, which are used to concentrate luminous or calorific rays in the same point.

We shall only consider the case of spherical mirrors. Fig. 328 represents two of these mirrors; fig. 327 gives a medial section, which is called the

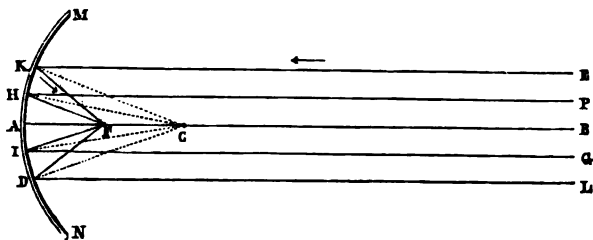

Fig. 327.

*principal section.* The centre C of the sphere to which the mirror belongs is called the *centre of curvature*; the point A, the middle of the reflector, is the *centre of the figure*; the straight line AB passing through these points, is the *principal axis* of the mirror.

In order to apply to spherical mirrors the laws of reflection from plane surfaces, they are considered to be composed of an infinite number of infinitely small plane surfaces, each belonging to the corresponding tangent



plane; the normals to these small surfaces are all radii of the same sphere, and therefore meet at its centre, the centre of curvature of the mirror.

Suppose now, on the axis  $AB$  of the mirror  $MN$ , a source of heat so distant that the rays  $EK, PH \dots$  which emanate from it may be considered as a parallel. From the hypothesis that the mirror is composed of an infinitude of small planes, the ray  $EK$  is reflected from the plane  $K$  just as from a plane mirror; that is to say,  $CK$  being the normal to this plane, the reflected ray takes a direction such that the angle  $CFK$  is equal to the angle  $CKE$ . The other rays,  $PH, GI \dots$  are reflected in the same manner, and all converge approximately towards the same point  $F$ , on the line  $AC$ . There is then a concentration of the rays in this point, and consequently a higher temperature than at any other point. This point is called the *focus*, and the distance from the focus to the mirror at  $A$  is the *focal distance*.

In the above figure the heat is propagated along the lines  $EKF, LDF$ , in the direction of the arrows; but, conversely, if the heated body be placed at  $F$ , the heat is propagated along the lines  $FKE, FDL$ , so that the rays emitted from the focus are nearly parallel after reflection.

408. **Verification of the laws of reflection.**—The following experiment, which was made for the first time by Pictet and Saussure, and which is



Fig. 328.

known as the *experiment of the conjugate mirrors*, demonstrates not only the existence of the foci, but also the laws of reflection. Two reflectors,  $M$  and  $N$  (fig. 328), are arranged at a distance of 4 to 5 yards, and so that their axes coincide. In the focus of one of them,  $A$ , is placed a small wire basket containing a red-hot iron ball. In the focus of the other is placed  $B$ , an inflammable body, such as gun-cotton or phosphorus. The rays

emitted from the focus A are first reflected from the mirror M, in a direction parallel to the axis (407), and impinging on the other mirror, N, are reflected so that they coincide in the focus B. That this is so is proved by the fact that the gun-cotton at this point takes fire, which is not the case if it is above or below it.

The experiment also serves to show that light and heat are reflected in the same manner. For this purpose a lighted candle is placed in the focus of A, and a ground-glass screen in the focus of B, when a luminous focus is seen on it exactly in the spot where the gun-cotton ignites. Hence the luminous and the calorific foci are produced at the same point, and the reflection takes place in both cases according to the same laws, for it will be afterwards shown that for light the angle of reflection is equal to the angle of incidence, and that both the incident and the reflected rays are in the same plane perpendicular to the plane reflecting surface.

In consequence of the high temperature produced in the foci of concave mirrors they have been called *burning mirrors*. It is stated that Archimedes burnt the Roman vessels before Syracuse by means of such mirrors. Buffon constructed burning mirrors of such power as to prove that the feat attributed to Archimedes was possible. The mirrors were made of a number of silvered plane mirrors about 8 inches long by 5 broad. They could be turned independently of each other in such a manner that the rays reflected from each coincided in the same point. With 128 mirrors and a hot summer's sun Buffon ignited a plank of tarred wood at a distance of 70 yards.

409. **Reflection in a vacuum.**—Heat is reflected in a vacuum as well as in air, as is seen from the following experiment (fig. 329), due to Sir Humphry Davy. Two small concave reflectors were placed opposite each other under the receiver of an air-pump. In the focus of one was placed a delicate thermometer, and in the focus of the other a platinum wire made incandescent by means of a galvanic current. The thermometer was immediately seen to rise several degrees, which could only be due to reflected heat, for the thermometer did not show any increase of temperature if it were not exactly in the focus of the second reflector.

410. **Apparent reflection of cold.**—If two mirrors are arranged as represented in fig. 328, and a piece of ice is placed in one of the foci instead of the red-hot ball, the surrounding temperature being greater than zero, a differential thermometer placed in the focus of the second reflector would exhibit a decrease in temperature of several degrees. This appears at first to be caused by the emission of *frigorific* rays from ice. It is, however, easily explained from what has been said about the mobile equilibrium of temperature (403). There is still an exchange of temperature,



Fig. 329.

but here the thermometer is the warmest body. As the rays which the thermometer emits are more intense than those emitted by the ice, the former gives out more heat than it receives, and hence its temperature sinks.

The sensation of cold experienced when we stand near a plaster or stone wall whose temperature is lower than that of our body, or when we stand in front of a wall of ice, is explained in the same way.

411. **Reflecting power.**—The *reflecting power* of a substance is its property of throwing off a greater or less proportion of incident heat.

This power varies in different substances. In order to study this power in different bodies without having recourse to as many reflectors, Leslie arranged his experiment as shown in fig. 330. The source of heat is a

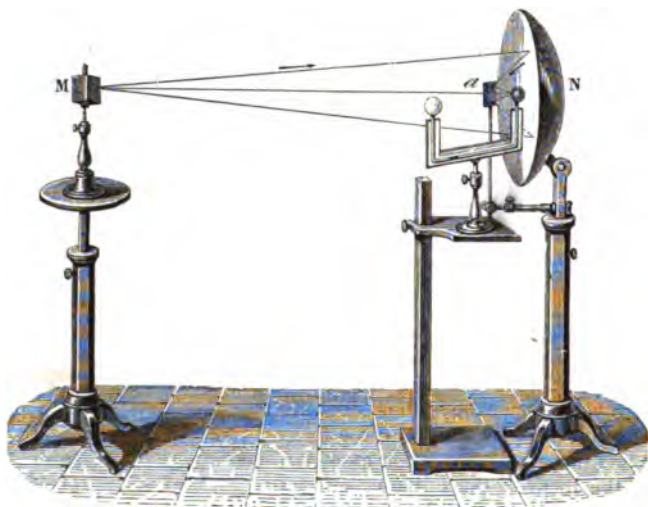

Fig. 330.

cubical canister, M, now known as *Leslie's cube*, filled with hot water. A plate, *a*, of the substance to be experimented upon is placed on the axis of a reflecting mirror between the focus and the mirror. In this manner the rays emitted by the source are first reflected from the mirror and impinge on the plate *a*, where they are again reflected and converge to a focus between the plate and the mirror, in which point a differential thermometer is placed. The reflector and the thermometer are always in the same position, and the water of the cube is always kept at  $100^{\circ}$ , but it is found that the temperature indicated by the thermometer varies with the nature of the plate. This method gives a means of determining, not the absolute reflecting power of a body, but its power relatively to that of some body taken as a standard of comparison. For from what has been said on the application of Newton's law to the differential thermometer, the temperatures which this instrument indicates are proportional to the quantities of heat which it receives. Hence, if in the above experiment a plate of glass causes the temperature to rise  $1^{\circ}$ , and a plate of lead  $6^{\circ}$ , it follows that the quantity of heat reflected by the

latter is six times as great as that reflected by the former. For the heat emitted by the source remains the same, the concave reflector receives the same portion, and the difference can only arise from the reflecting power of the plate *a*.

By this method Leslie determined the reflecting powers of the following substances, relatively to that of brass, taken as 100 :—

Polished brass . . . . .	100	Indian ink . . . . .	13
Silver . . . . .	90	Amalgamated tin . . . . .	10
Polished tin . . . . .	80	Glass . . . . .	10
Steel . . . . .	70	Oiled glass . . . . .	5
Lead . . . . .	60	Lampblack . . . . .	0

The numbers only represent the relative reflecting power as compared with that of brass. Their *absolute power* is the *relation of the quantity of heat reflected to the quantity of heat received*. Melloni was the first to determine the absolute reflecting power of a certain number of bodies. Desains and De la Provostaye, who also examined it for certain metals, obtained the following results by means of Melloni's thermo-multiplier (400), the heat being reflected at an angle of 50° :—

Silver plate . . . . .	0·97	Steel . . . . .	0·82
Gold . . . . .	0·95	Zinc . . . . .	0·81
Brass . . . . .	0·93	Iron . . . . .	0·77
Platinum . . . . .	0·83	Cast iron . . . . .	0·74

We shall presently see (415) what are the causes which modify the reflecting power.

**412. Absorbing power.**—The *absorbing power* of a body is its property of allowing a greater or less quantity of incident heat to pass into its mass. Its absolute value is the ratio of the quantity of heat absorbed to the quantity of heat received.

The absorbing power of a body is always inversely as its reflecting power : a body which is a good absorbent is a bad reflector, and *vice versa*. It was formerly supposed that the two powers were exactly complementary, that the sum of the reflected and absorbed heat was equal to the total quantity of incident heat. This is not the case ; it is always less : the incident heat is divided into three parts—1st, one which is absorbed ; 2nd, another which is reflected regularly—that is, according to laws previously demonstrated (405) ; and a third, which is irregularly reflected in all directions, and which is called *scattered or diffused heat*.

In order to determine the absorbing power of bodies, Leslie used the apparatus which he employed in determining the reflecting powers (411). But he suppressed the plate *a*, and placed the bulb of the thermometer in the focus of the reflector. This bulb being then covered successively with lampblack, or varnish, or with gold, silver, or copper foil, etc., the thermometer exhibited a higher temperature under the influence of the source of heat, *M*, according as the substance with which the bulb was covered absorbed more heat. Leslie found in this way that the absorbing power of a body is greater the less its reflecting power. In these experiments, however, the relation of the absorbing powers cannot be deduced from that of the temperatures indicated by the thermometer, for Newton's

law is not exactly applicable in this case, as it only prevails for bodies whose substance does not vary, and here the covering of the bulb varied with each observation. But we shall presently show (414) how the comparative absorbing powers may be deduced from the ratios of the emissive powers.

Taking as a source of heat a canister filled with water at  $100^{\circ}$ , Melloni found by means of the thermo-multiplier the following relative absorbing powers :—

Lampblack . . . . .	100	Indian ink . . . . .	85
White lead . . . . .	100	Shellac . . . . .	72
Isinglass . . . . .	91	Metals . . . . .	13

413. **Radiating power.**—The *radiating* or *emissive power* of a body is its capability of emitting, at the same temperature, and with the same extent of surface, greater or less quantities of heat.

The apparatus represented in fig. 330 was also used by Leslie in determining the radiating power of bodies. For this purpose the bulb of the thermometer was placed in the focus of the reflector, and the faces of the canister M were formed of different metals, or covered with different substances such as lampblack, paper, etc. The cube being filled with hot water, at  $100^{\circ}$ , and all other conditions remaining the same, Leslie turned each face of the cube successively towards the reflectors, and noted the temperature each time. That face which was coated with lampblack caused the greatest elevation of temperature, and the metal faces the least. Applying Newton's law, and representing the heat emitted by lampblack as 100, Leslie formed the following table of radiating powers :—

Lampblack . . . . .	100	Isinglass . . . . .	80
White lead . . . . .	100	Tarnished lead . . . . .	45
Paper . . . . .	98	Mercury . . . . .	20
Sealing wax . . . . .	95	Polished lead . . . . .	19
Ordinary white glass . . . . .	90	Polished iron . . . . .	15
Indian ink . . . . .	88	Tin, gold, silver, copper, etc. . . . .	12

It will be seen that, in this table, the order of the bodies is exactly the reverse of that in the tables of reflecting powers.

The radiating powers of several substances were determined by Melloni by the same method as that of Leslie, but using the thermo-multiplier instead of the differential thermometer. This has also since been done more exactly by Desains and De la Provostaye, who used the same instrument, but avoided certain sources of error incidental to previous methods. They found in this manner the following numbers compared with lampblack as 100 :—

Platinum foil . . . . .	1080	Pure silver laminated . . . . .	300
Burnished platinum . . . . .	950	„ burnished . . . . .	250
Silver deposited chemically . . . . .	536	„ deposited chemi-	
Copper foil . . . . .	490	„ cally and bur-	
Gold leaf . . . . .	428	nished . . . . .	225

It appears, therefore, that the radiating power found by Leslie for the metals is too large.

414. **Identity of the absorbing and radiating powers.**—The absorbing power of a body cannot be accurately deduced from its reflecting power, because the two are not exactly complementary. But the absorbing power would be determined if it could be shown that in the same body it is equal to the radiating power. This conclusion has been drawn by Dulong and Petit from the following experiments :—In a large glass globe, blackened on the inside, was placed a thermometer at a certain temperature,  $15^{\circ}$  for example ; the globe was kept at zero by surrounding it with ice, and having been exhausted by means of a tubulure connected with the air-pump, the time was noted which elapsed while the thermometer fell through  $5^{\circ}$ . The experiment was then made in the contrary direction, that is, the sides of the globe were heated to  $15^{\circ}$ , while the thermometer was cooled to zero : the time was then observed which the thermometer occupied in rising through  $5^{\circ}$ . It was found that this time was exactly the same as that which the thermometer had taken in sinking through  $5^{\circ}$ , and it was thence concluded that the radiating power is equal to the absorbing power for the same body, and for the same difference between its temperature and the temperature of the surrounding medium, because the quantities of heat emitted or absorbed in the same time are equal.

This point may also be demonstrated by means of the following apparatus devised by Ritchie. Fig. 331 represents what is virtually a differential thermometer, the two glass bulbs of which are replaced by two cylindrical reservoirs B and C, of metal, and full of air. Between them is a third and larger one A, which can be filled with hot water by means of a tubulure. The faces of B and of A, which face the right, are coated with lampblack ; those of C and of A, which face the left, are either painted white, or are coated with silver foil. Thus of the two faces opposite each other, one is black and the other white ; hence when the cylinder A is filled with hot water, its white face radiates towards the black face of B, and its black face towards the white face of C. Under these circumstances

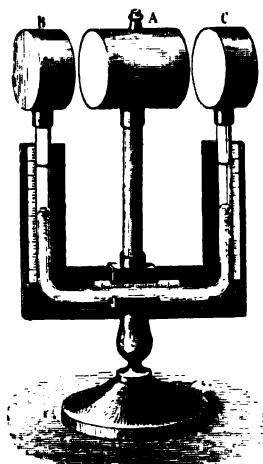

Fig. 331.

the liquid in the stem does not move, indicating that the two reservoirs are at the same temperature. On the one hand, the greater emissive power of the black face of A is compensated by the smaller absorptive power of the white face of C ; while, on the other hand, the feebler radiating power of the white face of A is compensated by the greater absorbing power of the black face of B.

The experiment may be varied by replacing the two white faces by discs of paper, glass, porcelain, &c.

415. **Causes which modify the reflecting, absorbing, and radiating powers.**—As the radiating and absorbing powers are equal, any cause which affects the one affects the other also. And as the reflecting power

varies in an inverse manner, whatever increases it diminishes the radiating and absorbing powers, and *vice versa*.

It has been already stated that these different powers vary with different bodies, and that metals have the greatest reflecting power, and lampblack the least. In the same body these powers are modified by the degree of polish, the density, the thickness of the radiating substance, the obliquity of the incident or emitted rays, and, lastly, by the nature of the source of heat.

It has been usually assumed that the reflecting power increases with the polish of the surface, and that the other powers diminish therewith. But Melloni showed that by scratching a polished metallic surface its reflecting power was sometimes diminished and sometimes increased. This phenomenon he attributed to the greater or less density of the reflecting surface. If the plate had been originally hammered, its homogeneity would be destroyed by this process, the molecules would be closer together on the surface than in the interior, and the reflecting power would be increased. But if the surface is scratched, the internal and less dense mass becomes exposed, and the reflecting power diminished. On the contrary, in a plate which has not been hammered, and which is homogeneous, the reflecting power is increased when the plate is scratched, because the density at the surface is increased by the scratches.

The experiments of Leslie, Rumford, and Melloni further prove that the thickness of the radiating substance also modifies its emissive power. The latter philosopher found that when the faces of a cube filled with water at a constant temperature were varnished, the emissive power increased with the number of layers up to 16 layers, and that above that point it remained constant, whatever the number. He calculated that the thickness of the 16 layers was 0.04 of a millimetre. With reference to metals, gold leaves of 0.008, 0.004, and 0.002 of a millimetre in thickness, having been successively applied on the sides of a cube of glass, the diminution of radiant heat was the same in each case. It appears, therefore, that, beyond certain limits, the thickness of the radiating layer of metal is without influence.

The absorbing power is greatest when the rays are at right angles; and it diminishes in proportion as the incident rays deviate from the normal. This is one of the reasons why the sun is hotter in summer than in winter, because, in the former case, the sun's rays are less oblique.

The radiating power of gaseous bodies in a state of combustion is very weak, as it is seen by bringing the bulb of a thermometer near a hydrogen flame, the temperature of which is very high. But if a platinum spiral be placed in this flame, it assumes the temperature of the flame, and radiates a considerable quantity of heat, as is indicated by the thermometer. It is for an analogous reason that the flames of oil and of gas lamps radiate more than a hydrogen flame, in consequence of the excess of carbon which they contain, and which, not being entirely burned, becomes incandescent in the flame.

416. **Melloni's researches on radiant heat.**—For our knowledge of the phenomena of the reflection, emission, and absorption of heat which have up to now been described, science is indebted mainly to Leslie. But

since his time the discovery of other and far more delicate modes of detecting and measuring heat, has not only extended and corrected our previous knowledge, but has led to the discovery of other phenomena of radiant



Fig. 332.



Fig. 333.

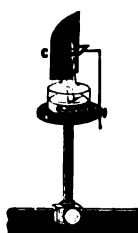

Fig. 334.



Fig. 335.

heat, which without such improved means must have remained unknown.

This advance in science is due to an Italian philosopher, Melloni, who first applied the thermo-electric pile, invented by Nobili, to the measurement of very small differences of temperature; a method of which a preliminary account has already been given (400).

In his experiments Melloni used five sources of heat—1st, a Locatelli's lamp—one, that is, without a glass chimney, but provided with a reflector (fig. 332); 2nd, an Argand lamp, that is, one with a chimney and a double draught; 3rd, a platinum spiral, kept red-hot by a spirit lamp (fig. 333); 4th, a blackened copper plate, kept at a temperature of about 400 degrees by a spirit lamp (fig. 334); 5th, a copper tube, blackened on the outside and filled with water at 100° (fig. 335).

**417. Dynamical theory of heat.**—Before describing the results arrived at by Melloni and others, it will be convenient to explain here the view now generally taken as to the mode in which heat is propagated. For additional information the chapter on the Mechanical Theory of Heat and the book on Light should be read. According to what has been already stated, a hot body is nothing more than one whose particles are in a state of vibration. The higher the temperature of the body the more rapid are these vibrations, and a diminution in temperature is but a diminished rapidity of vibration of the particles. The propagation of heat through a bar is due to a gradual communication of this vibratory motion from the heated part to the rest of the bar. A good conductor is one which readily takes up and transmits the vibratory motion from particle to particle, while a bad conductor is one which takes up and transmits the motion with difficulty. But even through a good conductor the propagation of this motion is comparatively slow; how then are we to explain the instantaneous perception of heat experienced when a screen is removed from a fire, or when a cloud is drifted from the face of the sun? In this case, the heat passes from one body to another without affecting the temperature of the medium which transmits it. In order to



explain these phenomena, it is imagined that all space, the interplanetary spaces as well as the interstices in the hardest crystal or the heaviest metal, in short, matter of any kind, is permeated by a medium having the properties of a fluid of infinite tenuity called *ether*. The particles of a heated body being in a state of intensely rapid vibration, communicate their motion to the ether around them, throwing it into a system of waves which travel through space and pass from one body to another with the velocity of light. When the undulations of the ether reach a given body, the motion is again delivered up to the particles of that body, which in turn begin to vibrate, that is, the body becomes heated. This passage of motion through the hypothetical ether is termed radiation, and a so-called ray of heat is merely the direction of the motion of one series of waves.

It will facilitate the understanding of this to consider the analogous mode in which sound is produced and propagated. A sounding body is one whose entire mass is in a state of vibration; the more rapid the rate of vibration, the more acute the sound; the slower the rate of vibration, the deeper the sound. This vibratory motion is communicated to the surrounding air, by means of which the vibrations reach the auditory nerve, and there produce the sensation of sound. If a metal ball be heated, say to the temperature of boiling water, we can ascertain that it radiates heat, although we cannot see any luminosity; and if its temperature be gradually raised, we see it become successively of a dull red, bright red, and dazzling white. Here it is assumed that at each particular temperature the heated body emits waves of a definite length; in other words, its particles vibrate in a certain period. As its temperature rises it sends out other and more rapid undulations, which coexist, however, with all those which it had previously emitted. Thus the motion at each successive temperature is compounded of all preceding ones.

It has been seen that vibrations of the air below and above a certain rate do not affect the auditory nerve; it can only take up and transmit to the brain vibrations of a certain periodicity. So too with the vibrations which produce heat. The optic nerve is insensible to a large number of wave lengths. It can apprehend only those waves that form the visible spectrum. If the rate of undulation be slower than the red or faster than the violet, though intense motion may pass through the humours of the eye and fall upon the retina, yet we shall be utterly unconscious of the fact, for the optic nerve cannot take up and respond to the rate of vibrations which exist beyond the visible spectrum in both directions. Hence these are termed *invisible* or *obscure* rays. A vast quantity of these obscure rays are emitted by flames which, though intensely hot, are yet almost non-luminous, such as the oxy-hydrogen flame, or that of a Bunsen's burner; for the vibrations which these emit, though capable in part of penetrating the media of the eye, are incapable of exciting in the optic nerve the sensation of light.

**418. Thermal analysis of solar light.**—When a solar ray (fig. 336), admitted through an aperture in a dark room, is concentrated on a prism of rock salt by means of a lens of the same material, and then, after emerging from the prism, is received on a screen, it will be found to present a band of colours in the following order: red, orange, yellow, green, blue, and violet. This is called the *spectrum*.

If now a narrow and delicate thermo-pile be placed successively on the

space occupied by each of the colours, it will be scarcely affected on the violet, but in passing over the other colours it will indicate a gradual rise of temperature, which is greatest at the red. Painters, thus guided by a cor-

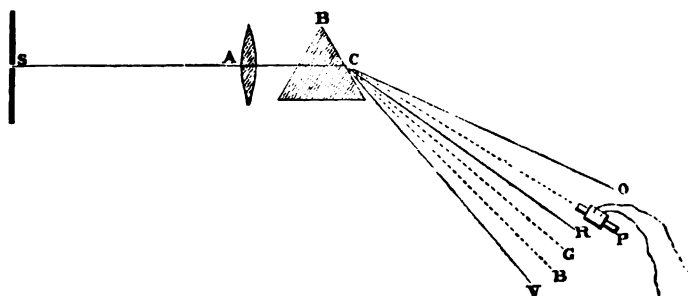

Fig. 336.

rect but unconscious feeling, always speak of blue and green colours as cold, and of red and orange as warm tones. If the pile be now moved in the same direction beyond the limits of the luminous spectrum, the temperature will gradually rise up to CP, at which it attains its maximum. From this point the pile indicates a decrease of temperature until it reaches a point, O, where it ceases to be affected. This point is about as distant from R as the latter is from V; that is, there is a region in which thermal effects are produced extending as far beyond the red end of the spectrum in one direction as the entire length of the visible spectrum is in the other. In accordance with what we have stated, the sun's light consists of rays of different rates of vibration; by their passage through the prism they are unequally broken or refracted; those of greatest wave-length or slowest vibrating period are least bent aside, or are said to be the least refrangible, while those with shorter wave-lengths are the most refrangible.

These non-luminous rays outside the red are called the extra or ultra-red rays, or sometimes the *Herschelian rays*, from Sir W. Herschel, who first discovered their existence.

If in the above case prisms of other materials than rock salt be used, the position of maximum heat will be found to vary with the nature of the prism, a fact first noticed by Seebeck. Thus with a prism of water it is in the yellow; with one of crown glass, in the middle of the red, and so on. These changes are due, as Melloni subsequently found, to the circumstance that prisms of different materials absorb rays of different refrangibility to unequal extents. But rock salt practically allows heats of all kinds to pass with equal facility, and thus gives a normal spectrum.

419. **Tyndall's researches.**—Tyndall investigated the spectrum produced by the electric light, by the following mode of experimenting. The electric light was produced between charcoal points by a Grove's battery of fifty cells. The beam rendered parallel by a double rock salt lens, was caused to pass through a narrow slit, and then through a second lens of rock salt; the slices of white light thus obtained being decomposed by a prism of the same material. To investigate the thermal conditions of the spec-

trum a *linear* thermo-electric pile was used; that is, one consisting of a number of elements arranged in a line, and in front of which was a slit that could be narrowed to any extent. The instrument was mounted on a movable bar connected with a fine screw, so that by turning a handle the pile could be pushed forward through the smallest space. On placing this apparatus, successively in each part of the spectrum of the electric light, the heating effected at various points near each other was determined by the indications of a very delicate galvanometer. As in the case of the solar spectrum, the heating effect gradually increased from the violet end towards the red, and was greatest in the dark space beyond the red. The position of the greatest heat was about as far from the limit of the visible red as the latter was from the green, and the total extent of the invisible spectrum was found to be twice that of the visible.

The increase of temperature in the dark space is very considerable. If thermal intensities are represented by perpendicular lines of proportionate length, erected at those parts of the spectrum to which they correspond, on passing beyond the red end these lines increase rapidly and greatly in length, reach a maximum, and then fall somewhat more suddenly. If these lines are connected, they form a curve (fig. 337), which beyond the red re-

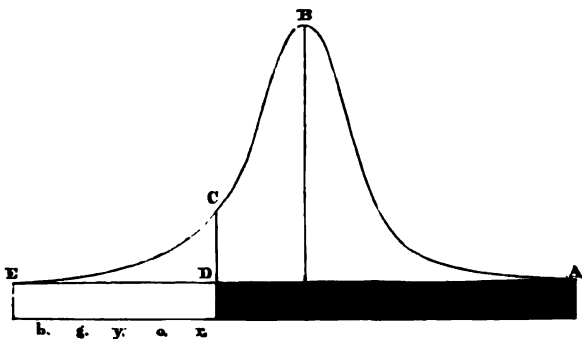

Fig. 337.

presents a massive peak, which quite dwarfs by its magnitude that of the visible spectrum. In fig. 338, the dark parts at the end represent the obscure radiation. The curve is based, in the manner above stated, on the results obtained by Tyndall with the electric light. The upper curve in fig. 338, represents the spectrum of sun light from the experiments of Müller with a rock-salt prism, while the lower curve represents the results obtained with the use of a flint-glass prism, which is thus seen to absorb some of the ultra-red radiation.

Tyndall found that by interposing various substances, more especially water, in certain thicknesses, in the path of the electric light, the ultra-red radiation was greatly diminished, the peak was not so lofty. Now aqueous vapour would, like water, absorb the obscure rays. And most probably the reason why the obscure part of the spectrum of sun light is not so intense as in the case of the electric light is that the obscure rays have been

already partially absorbed by the aqueous vapour of the atmosphere. If a solar spectrum could be produced outside the atmosphere, it doubtless

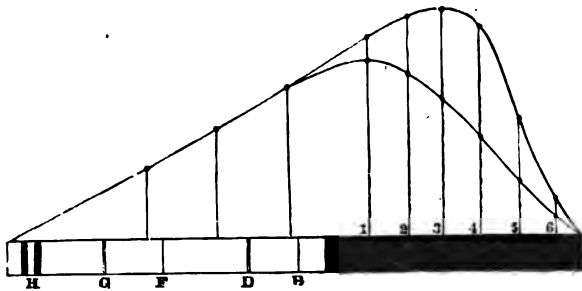

Fig. 338.

would give a spectrum more like that of the electric light, which is uninfluenced by the atmospheric absorption.

This has been remarkably confirmed in other ways. Melloni observed that the position of the maximum in the solar spectrum differs on different days; which is probably due to the varying absorption of the atmosphere, in consequence of its varying hygrometric state. Recently, Secchi, in Rome, has found the same shifting of the maximum to occur in the different seasons of the year; for in winter, when there is least moisture in the atmosphere, the maximum is farther from the red than in summer, when the aqueous vapour in the air is most abundant. An important observation on the luminous rays has also been made by Cooke, in America, who found that the faint black lines in the solar spectrum attributed to the absorption of light by our atmosphere (see book on Optics) are chiefly caused by the presence of aqueous vapour.

**420. Luminous and obscure radiation.**—It has been stated that the radiation from a luminous object, a gas flame for example, is of a composite character; a portion consists of what we term light, but a far greater part consists of heat rays, which are insensible to our eyes, being unable to affect the optic nerve. When this mixed radiation falls upon the blackened face of a thermo-electric pile, the whole of it is taken to be absorbed, the light by this act being converted into heat, and affecting the instrument proportionally with the purely calorific rays. The total radiation of a luminous source, expressed in units of heat or force, can thus be measured. By introducing into the path of the rays a body capable of stopping either the luminous or the obscure radiation, we can ascertain by the comparative action on the pile the relative quantities of heat and light radiated from the source. Melloni sought to do this by passing a luminous beam through a layer of water containing alum in solution; a liquid which he found in previous experiments absorbed all the radiation from bodies heated under incandescence. Comparing the transmission through this liquid—which allowed the luminous part of the beam to pass, but quenched the obscure portion—with the transmission through a plate of rock salt—which affected neither the luminous nor the obscure radiation, but gave the loss due to reflection—Melloni found

that 90 per cent. of the radiation from an oil flame and 99 per cent. of the radiation from an alcohol flame consist of invisible calorific rays. This proportion has been still further increased by the recent experiments of Tyndall, who employed a liquid free from the objections which caused a slight error in Melloni's method; he discovered that iodine, whilst opaque to light, is transparent to the obscure heat rays. A solution of this substance in bisulphide of carbon was found to be impervious to the most intense light, but very pervious to radiant heat; only a slight absorption being effected by the bisulphide. By successively comparing the transmission through the transparent liquid, and the transmission through the same liquid rendered opaque by iodine, the value of the luminous radiation from various sources was found to be as follows:—

Source	Luminous	Obscure
Red-hot spiral . . . . .	0	100
Hydrogen flame . . . . .	0	100
Oil flame . . . . .	3	97
Gas flame . . . . .	4	96
White-hot spiral . . . . .	4·6	95·4
Electric light . . . . .	10	90

Here by direct experiment the ratio of luminous to obscure rays in the electric light is found to be 10 per cent. of the total radiation. By prismatic analysis, the curve shown in fig. 337 was obtained. Graphically representing the proportion of luminous to obscure rays in the electric light; by calculating the areas of the two spaces in the diagram, the obscure portion DCBA, is found to be nearly 10 times as large as the luminous one DCE.

421. **Transmutation of obscure rays.**—We shall find, in speaking of the luminous spectrum, that beyond the violet there are rays which are invisible to the eye, but which are distinguished by their chemical action, and are spoken of as the *actinic* or chemical rays; they are also known as the *Ritteric* rays, from the philosopher who first discovered their existence.

As we shall afterwards see in the book on Optics, Stokes has succeeded in converting these rays into rays of lower refrangibility, which then become visible; so Tyndall has recently effected the corresponding but inverse change, and has increased the refrangibility of the Herschelian or extra red rays, and thus rendered them visible. He worked with the electric light. The charcoal points were placed in front of a concave silvered glass mirror in such a manner that the rays from the points after reflection were concentrated to a focus about 6 inches distant. On the path of the beam was interposed a cell full of a solution of iodine in bisulphide of carbon, which (420) has the power of completely stopping all luminous radiation, but gives free passage to the non-luminous rays. On now placing in the focus of the beam thus sifted a piece of platinum, this was raised to incandescence by the impact of perfectly invisible rays. In like manner a piece of charcoal *in vacuo* was heated to redness.

By a proper arrangement of the charcoal points a metal may be raised to whiteness, and the light now emitted by the metal yields on prismatic analysis a brilliant luminous spectrum, which is thus entirely derived from the invisible rays beyond the red. To the new phenomena here described,

to this transmutation of non-luminous into luminous heat, Tyndall has applied the term *calorescence*.

When the eye was cautiously placed in the focus, guarded by a small hole being pierced in a metal screen, so that the converged rays should only enter the pupil and not affect the surrounding part of the eye, no impression of light was produced, and there was scarcely any sensation of heat. A considerable portion was absorbed by the humours of the eye, but yet a powerful beam undoubtedly reached the retina; for, as Tyndall showed by a separate experiment, about 18 per cent. of the obscure radiation from the electric light passed through the humours of an ox's eye.

422. **Transmission of thermal rays.**—Melloni was the first who examined extensively and accurately the absorption of heat by solids and liquids. The apparatus he employed is represented in the annexed figure (339), where A B is the thermo-electric pile; *a* is a support for the source of

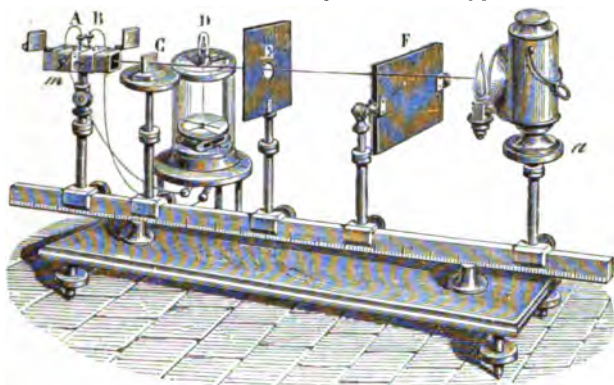

Fig. 339.

heat, in this case a Locatelli's lamp; F and E are screens, and C is a support for the body experimented on; while *m* is the support for the pile, and D the galvanometer.

The various sources of heat used by Melloni in his experiments have been already (416) enumerated.

To express the power which bodies have of transmitting heat, Melloni used the term *diathermancy*: diathermancy bears the same relation to radiant heat that transparency does to light; and in like manner the power of stopping radiant heat is called *athermancy*, which thus corresponds to opacity for light. In experimenting on the diathermancy of liquids, Melloni used glass troughs with parallel sides, the thickness of the liquid layer being 0.36 in. The radiant heat of an Argand lamp with a glass chimney was first allowed to fall directly on the face of the pile, and the deflection produced in the galvanometer taken as the total radiation; the substance under examination was then interposed, and the deflection noted. This corresponded to the quantity of heat transmitted by the substance. If *t* indicate this latter number, and *t'* the total radiation, then

$$t' : t :: 100 : x,$$

which is the percentage of rays transmitted. Thus, calling the total radiation 100, Melloni found that

Bisulphide of carbon transmitted . . . . .	63
Olive oil . . . . .	30
Ether . . . . .	21
Sulphuric acid . . . . .	17
Alcohol . . . . .	15
Solution of alum or sugar . . . . .	12
Distilled water . . . . .	11

In experimenting with solids they were cut into plates 0·1 inch in thickness, and it was found that of every 100 rays there was transmitted by

Rock salt . . . . .	92	Selenite . . . . .	20
Smoky quartz . . . . .	67	Alum . . . . .	12
Transparent carbonate of lead . . . . .	52	Sulphate of copper . . . . .	0

The transmission of heat through liquids has been re-examined by Tyndall in the following way :—Instead of employing a glass vessel to hold the liquids under examination, he made use of a little cell whose ends were stopped by parallel plates of rock salt. The plates were separated by a ring of brass, with an aperture on the top through which the liquid could be poured. As this plate could be changed at will, liquid layers of various thicknesses were easily obtainable, the apparatus being merely screwed together and made liquid-tight by paper-washers. The instrument was mounted on a support before an opening in a brass screen placed in front of the pile. The source of heat employed was a spiral of platinum wire raised to incandescence by an electric current; the spiral being enclosed in a small glass globe with an aperture in front, through which the radiation passed unchanged in its character, a point of essential importance overlooked by Melloni. The following table contains the results of experiments made with liquids in the various thicknesses indicated, the numbers expressing the *absorption* per cent. of the total radiation. The *transmission* per cent. can be found in each case by subtracting the absorption from 100.

*Absorption of heat by liquids.*

Liquid	Thickness of liquid in parts of an inch.				
	0·02	0·04	0·07	0·14	0·27
Bisulphide of carbon . . . . .	5·5	8·4	12·5	15·2	17·3
Chloroform . . . . .	16·6	25·0	35·0	40·0	44·8
Iodide of methyl . . . . .	36·1	46·5	53·2	65·2	68·6
Benzole . . . . .	43·4	55·7	62·5	71·5	73·6
Amylene . . . . .	58·3	65·3	73·6	77·7	82·3
Ether . . . . .	63·3	73·5	76·1	78·6	85·2
Alcohol . . . . .	67·3	78·6	83·6	85·3	89·1
Water . . . . .	80·7	86·1	88·8	91·0	91·0

Thus a layer of water 0·2 inch thick absorbs 80·7 and transmits 19·3 per cent. of the radiation from a red-hot spiral.

It appears from these tables that there is no connection between diathermancy and transparency. The liquids, except olive oil, are all colourless and transparent, and yet vary as much as 75 per cent. in the amount of heat transmitted. Among solids, smoky quartz, which is nearly opaque to light, transmits heat very well; while alum, which is perfectly transparent, cuts off 88 per cent. of heat rays. As there are different degrees of transparency, so there are different degrees of diathermancy; and the one cannot be predicated from the other.

By studying the transmission of heat from different parts of the spectrum separately, the connection between light and heat becomes manifest. With this view Masson and Jamin received the spectrum of the solar light given by a prism of rock salt on a movable screen provided with an aperture, so that by raising or lowering the screen the action of any given part of the spectrum on different plates could be investigated. They thus found—

That glass, rock crystal, ice, and generally substances transparent for light, are also diathermanous for all kinds of *luminous* heat;

That a coloured glass, red, for instance, which only transmits the red rays of the spectrum, and extinguishes the others, also extinguishes every kind of luminous heat, excepting that of the red rays;

That glass and rock crystal, which are diathermanous for luminous heat, also transmit the obscure heat near the red, that is, the most refrangible, but extinguish the extreme obscure rays, or those which are the least deflected by the prism.

Alum extinguishes a still greater proportion of the obscure spectrum, and ice stops it altogether.

423. **Influence of the nature of the heat.**—The diathermanous power differs greatly with the heat from different sources, as Melloni made evident from the following table, in which the numbers express what proportion of every 100 rays from the different sources of heat incident on the plates is transmitted:—

	Locatelli's lamp	Incandescent platinum wire	Copper at 400°	Copper at 100°
Rock salt . . . .	92	92	92	92
Fluor spar . . . .	78	69	42	33
Plate glass . . . .	39	24	6	0
Black glass . . . .	26	55	12	0
Selenite . . . . .	14	5	0	0
Alum . . . . .	9	2	0	0
Ice . . . . .	6	0.5	0	0

These different sources of heat correspond to light from different sources. Rock salt is here stated to transmit all kinds of heat with equal facility, and to be the only substance which does so. It is analogous to white glass, which is transparent for light from all sources. Fluor spar transmits 78 per cent. of the rays from a lamp, but only 33 of those from a blackened surface at 100°. A piece of plate glass only one-tenth of an inch thick, and perfectly



transparent to light, is opaque to all the radiation from a source of  $100^{\circ}$ , transmits only 6 per cent. of the heat from a source at  $400^{\circ}$ , and but 39 of the radiation from the lamp. Black glass, on the contrary, though it cuts off all heat from a source at  $100^{\circ}$ , allows 12 per cent. of the heat at  $400^{\circ}$  to pass, and is equally transparent to the heat from the spiral, but on account of its blackness is more opaque to the heat from the lamp. As we have already seen, every luminous ray is a heat ray; now as several of the substances in this table are pervious to all the luminous rays, and yet, as in the case of ice, transmit about 6 per cent. of luminous heat, we have an apparent anomaly; which, however, is only a confirmation of the remarkably small proportion which the luminous rays of a lamp bear to the obscure.

From these experiments Melloni concluded that as the temperature of the source rose, more heat was transmitted. This general law has been confirmed by some experiments of Tyndall. The platinum lamp, previously described, was used as the source, the temperature of which could be varied from a dark to a brilliant white heat, without disturbing in any way the position of the apparatus; the gradations of temperature being obtained by a gradual augmentation of the strength of the electric current which heated the platinum spiral. Instead of liquids, vapours were examined in a manner to be described subsequently; the measurements are given in the following table:—

*Absorption of heat by vapours.*

Name of vapour.	Source, platinum spiral.			
	Barely visible	Bright red	White hot	Near fusion
Bisulphide of carbon . . . . .	6.5	4.7	2.9	2.5
Chloroform . . . . .	9.1	6.3	5.6	3.9
Iodide of methyl . . . . .	12.5	9.6	7.8	
Benzole . . . . .	26.4	20.6	16.5	
Ether . . . . .	43.4	31.4	25.9	23.7
Formic ether . . . . .	45.2	31.9	25.1	21.3
Acetic ether . . . . .	49.6	34.6	27.2	

The percentage of rays absorbed is here seen to diminish in each case as the temperature of the source rises. Mere elevation of temperature does not, however, invariably produce a high penetrative power in the rays emitted; the rays from sources of far higher temperature than any of the foregoing are more largely absorbed by certain substances than are the rays emitted from any one of the sources as yet mentioned. Thus Tyndall found that the radiation from a hydrogen flame was completely intercepted by a layer of water only 0.27 of an inch thick, the same layer transmitting 9 per cent. of the radiation from the red-hot spiral, a source of much lower temperature. The explanation of this is, that those rays which heated water emits (and water, the product of combustion, is the main radiant in a hydrogen flame) are the very ones which this substance most largely absorbs. This statement, which will become clearer after reading the analogous

phenomena in the case of light, was strikingly exemplified by the powerful absorption of the heat from a carbonic oxide flame by carbonic acid gas. It will be seen presently (426) that of the rays from a heated plate of copper, olefiant gas absorbs 10 times the quantity intercepted by carbonic acid, whilst of the rays from a carbonic oxide flame Tyndall found carbonic acid absorbed twice as much as olefiant gas. A tenth of an atmosphere of carbonic acid, enclosed in a tube 4 feet long, absorbs 60 per cent. of the radiation from a carbonic oxide flame. Radiant heat of this character can thus be used as a delicate test for the presence of carbonic acid, the amount of which can even be accurately measured by the same means. This has been done by Prof. Barrett, who, in this way, has made a *physical* analysis of the human breath. In one experiment the quantity of carbonic acid contained in breath physically analysed was found to be 4.65 per cent., whilst the same breath chemically analysed gave 4.66 per cent.

**424. Influence of the thickness and nature of screens.**—It will be seen from the table (423) that of every 100 rays rock salt transmits 92. The other 8 may either have been absorbed or reflected from the surface of the plate. According to Melloni, the latter is the case; for if, instead of on one plate, heat be allowed to fall on two or more plates whose total thickness does not exceed that of the one, the quantity of heat arrested will be proportional to the number of reflecting surfaces. He therefore concluded rock salt to be quite diathermanous.

The experiments of later observers show that this conclusion is not strictly correct; rock salt does absorb a very small proportion of obscure rays.

The quantity of heat transmitted through rock salt is practically the same, whether the plate be 1, 2, or 4 millimetres thick. But with other bodies absorption increases with the thickness, although by no means in direct proportion. This is seen to be the case in the table of absorption by liquids at different thicknesses. The following table tells what proportion of 1,000 rays from a Locatelli's lamp pass through a glass plate of the given thickness:—

Thickness in millimetres	. 0.5	1	2	3	4	5	6	7	8
Rays transmitted	. 775	733	682	653	634	620	609	600	592

The absorption takes place in the first layers; the rays which have passed these possess the property of passing through other layers in a higher degree, so that beyond the first layers the heat transmitted approaches a certain constant value. If a thin glass plate be placed behind another glass plate a centimetre thick, the former diminishes the transmission by little more than the reflection from its surface. But if a plate of alum were placed behind the glass plate, the result would be different, for the latter is opaque for much of the heat transmitted by glass.

Heat, therefore, which has traversed a glass plate traverses another plate of the same material with very slight loss, but is very greatly diminished by a plate of alum. Of 100 rays which had passed through green glass or tourmaline, only 5 and 7 were respectively transmitted by the same plate of alum. A plate of blackened rock salt only transmits obscure rays, while alum extinguishes them. Consequently, when these two substances are superposed, a system impervious to light and heat is obtained.

These phenomena find their exact analogies in the case of light. The different sources of heat correspond to flames of different colours, and the various screens to glasses of different colours. A red flame looked at through a red glass appears quite bright, but through a green glass it appears dim or is scarcely visible. So in like manner heat which has traversed a red glass passes through another red glass with little diminution, but it is almost completely stopped by a green glass. Rock salt at  $150^{\circ}$  emits only one kind of heat; it is monothermal just as sodium vapour is monochromatic.

Different luminous rays being distinguished by their colours, to these different obscure calorific rays Melloni gives the name of *thermocrose* or heat coloration. The invisible portion of the spectrum is accordingly mapped out into a series of spaces, each possessing its own peculiar feature corresponding to the coloured spaces which are seen in that portion of the spectrum visible to our eyes.

Besides thickness and colour, the polish of a substance influences the transmission. Glass plates of the same size and thickness transmit more heat as their surface is more polished. Bodies which transmit heat of any kind very readily are not heated. Thus a window pane is not much heated by the strongest sun's heat; but a glass screen held before a common fire stops most of the heat, and is itself heated thereby. The reason of this is that by far the greater part of the heat from a fire is obscure, and to this kind of heat glass is opaque.

425. **Diffusion of heat.**—When a ray of light falls upon an unpolished surface in a definite direction, it is decomposed into a variety of rays which are reflected from the surface in all directions. This irregular reflection is called *diffusion*, and it is in virtue of it that bodies are visible when light falls upon them. A further peculiarity is, that all solar rays are not equally diffused from the surface of bodies. Certain bodies diffuse certain rays and absorb others, and accordingly appear coloured. The red colour of a geranium is caused by its absorbing all the rays, excepting the red, which are irregularly reflected. Just as is the case with transmitted light in transparent bodies, so with diffused light in opaque ones; for if a red body is illuminated by red light it appears of a bright red colour, but if green light fall upon it it is almost black. We shall now see that here again analogous phenomena prevail with heat.

Various substances diffuse different thermal rays to a different extent; each possesses a peculiar thermocrose or heat tint. Melloni placed a number of strips of brass foil between the source of heat and the thermo-pile. They were coated on the side opposite to the pile with lampblack, and on the other side with the substances to be investigated. Representing the quantity of heat absorbed by the lampblack at 100, the absorption of the other bodies was as follows:—

	Incandescent platinum	Copper at $400^{\circ}$	Copper at $100^{\circ}$
Lampblack . . . .	100	100	100
White lead . . . .	56	89	100
Isinglass . . . .	54	64	91
Indian ink . . . .	95	87	85
Shellac . . . .	47	70	72
Polished metal . . .	13.5	13	13

Hence, white lead absorbs far less of the heat radiated from incandescent platinum than lampblack, but it absorbs the obscure rays from copper at  $100^{\circ}$  as completely as lampblack. Indian ink is the reverse of this; it absorbs obscure rays less completely than luminous rays. Lampblack absorbs the heat from all sources in equal quantities, and very nearly completely. In consequence of this property all thermoscopes which are used for investigating radiant heat are covered with lampblack, as it is the best known absorbent of heat. The behaviour of metals is the reverse of that of lampblack. They reflect the heat of different sources in the same degree. They are to heat what *white* bodies are to light.

As coloured light is altered by diffusion from several bodies, so Knoblauch has shown that the different kinds of heat are altered by reflection from different surfaces. The heat of an Argand lamp diffused from white paper passes more easily through calcspar than when it has been diffused from black paper.

The rays of heat, like the rays of light, are susceptible of polarisation and double refraction. These properties will be better understood after treating of light.

426. **Relation of gases and vapours to radiant heat.**—For a long time it was believed that gaseous bodies were as permeable to heat as a vacuum; and though subsequently this was disproved, yet down to a recent period it was thought that whatever absorption such bodies might exercise was slight and similar in degree. The whole subject has, however, been investigated by Tyndall; the apparatus he used is represented in the adjacent figure, the arrangement being looked upon from above.

A (fig. 340) is a cylinder about 4 feet in length and  $2\frac{1}{2}$  inches in diameter,

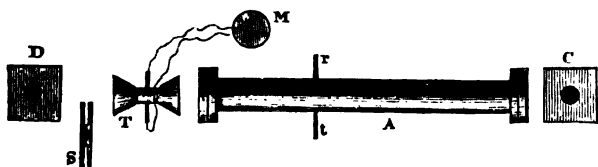

Fig. 340.

placed horizontally, the ends of which can be closed with rock salt plates: by means of a lateral tube at  $r$  it can be connected with an air-pump and exhausted; while at  $t$  is another tube which serves for the introduction of gases and vapours.  $T$  is a sensitive thermo-pile connected with an extremely delicate galvanometer,  $M$ .

The deflections of this galvanometer were proportional to the degrees of heat up to about  $30^{\circ}$ ; beyond this point the proportionality no longer held good, and accordingly, for the higher degrees, a table was empirically constructed, in which the value of the higher deflections was expressed in units; the unit being the amount of heat necessary to move the needle through one of the lower degrees.

$C$  is a source of heat, which usually was either a Leslie's cube filled with boiling water, or else a sheet of blackened copper heated by gas. Now, when the source of heat was permitted to radiate through the exhausted

tube, the needle made a great deflection ; and in this position a very considerable degree of absorption would have been needed to produce an alteration of  $1^\circ$  of the galvanometer. And if to lessen this deflection a lower source of heat had been used, the fraction absorbed would be correspondingly less, and might well have been insensible. Hence Tyndall adopted the following device, by which he was enabled to use a powerful flux of heat, and at the same time to discover small variations in the quantity falling on the pile.

The source of heat at C was allowed to radiate through the tube at the end of which the pile was placed ; a deflection was produced of, say,  $70^\circ$  ; a second source of heat, D, was then placed near the other face of the pile, the amount of heat falling on the pile from this *compensating* cube being regulated by means of a movable screen S. When both faces of the pile are warmed, two currents are produced, which are in opposite directions, and tending, therefore, to neutralise each other : when the heat on both faces is precisely equal the neutralisation is perfect, and no current at all is produced, however high may be the temperature on both sides. In the arrangement just described, by means of the screen S, the radiation from the compensating cube was caused to neutralise exactly the radiation from the source C ; the needle consequently was brought down from  $70^\circ$  to zero, and remained there so long as both sources were equal. If now a gas or vapour be admitted into the exhausted tube, any power of absorption it may possess will be indicated by the destruction of this equilibrium, and preponderance of the radiation from the compensating cube, by an amount corresponding to the heat cut off by the gas. Examined in this way, air, hydrogen, and nitrogen, when dried by passing through sulphuric acid, were found to exert an almost inappreciable effect ; their presence as regards radiant heat being but little different to a vacuum. But with olefiant and other complex gases the case was entirely different. Representing by the number 1 the quantity of radiant heat absorbed by air, olefiant gas absorbs 970 times, and ammoniacal gas 1,195 times this amount. In the following table is given the absorption of obscure heat by various gases, referred to air as unity :—

Name of gas	Absorption under 30 inches pressure
Air . . . . .	1
Oxygen . . . . .	1
Nitrogen . . . . .	1
Hydrogen . . . . .	1
Chlorine . . . . .	39
Hydrochloric acid . . . . .	62
Carbonic acid . . . . .	90
Nitrous oxide . . . . .	355
Marsh gas . . . . .	403
Sulphurous acid . . . . .	710
Olefiant gas . . . . .	970
Ammonia . . . . .	1,195

If, instead of comparing the cases at a common pressure of one atmosphere, they are compared at a common pressure of an inch, their differences in absorption are still more strikingly seen. Thus, assuming the absorption by

1 inch of dry air to be 1, the absorption by 1 inch of olefiant gas is 7,950, and by the same amount of sulphurous acid 8,800.

427. **Influence of pressure and thickness on the absorption of heat by gases.**—The absorption of heat by gases varies with the pressure; this variation cannot be seen in the case of air, as the total absorption is so small, but in the case of those gases which have considerable absorptive power it is easily shown. Taking the total absorption by atmospheric air under ordinary pressure at unity, the numbers of olefiant gas under a pressure of 1, 3, 5, 7, and 10 inches of mercury are respectively 90, 142, 168, 182, and 193. Thus one-thirtieth of an atmosphere of olefiant gas exerts 90 times the absorption of an entire atmosphere of air. And the absorption, it is seen, increases with the density, though not in a direct ratio. Tyndall showed, however, by special experiments, that for very low pressures the absorption does increase with the density. Employing as a unit volume of the gas a quantity which measured only  $\frac{1}{30}$ th of a cubic inch, and admitting successive measures of olefiant gas into the experimental tube, it was found that up to 15 measures the absorption was directly proportionate to the density in each case.

In these experiments the length of the experimental tube remained the same whilst the pressure of the gas within it was caused to vary; in other subsequent experiments the pressure of the gas was kept constant, whilst the length of the tube was, by suitable means, varied from 0.01 of an inch up to 50 inches. The source was a heated plate of copper; of the total radiation from this nearly 2 per cent. was absorbed by a film of olefiant gas 0.01 of an inch thick, upwards of 9 per cent. by a layer of the same gas 0.1 of an inch thick, 33 per cent. by a layer 2 inches thick, 68 per cent. by a column 20 inches long, and 77 per cent. by a column rather more than 4 feet long.

428. **Absorptive power of vapours.**—The absorptive power of olefiant gas is exceeded by that of several vapours. The mode of experimenting was analogous to that with the gases. The liquid from which the vapours were to be derived was enclosed in a small flask, which could be attached with a stopcock to the exhausted experimental tube. The absorption was then determined after admitting the vapours into the tube in quantities measured by the pressure of the barometer gauge attached to the air-pump.

The following table shows the absorption of vapours under pressures varying from 0.1 to 1.0 inch of mercury:—

Name of vapours	Absorption under pressure in inches of mercury		
	0.1	0.5	1.0
Bisulphide of carbon . . . . .	15	47	62
Benzole . . . . .	66	182	267
Chloroform . . . . .	85	182	236
Ether . . . . .	300	710	870
Alcohol . . . . .	325	622	
Acetic ether . . . . .	590	980	1195

These numbers refer to the absorption of a whole atmosphere of dry air as their unit, and it is thus seen that a quantity of bisulphide of carbon vapour, the feeblest absorbent yet examined, which only exerts a pressure of  $\frac{1}{30}$ th of an inch of mercury, or the  $\frac{1}{300}$ th of an atmosphere, gave 15 times the absorption of an entire atmosphere of air; and  $\frac{1}{10}$ th of an inch of acetic

ether 590 times as much. Comparing air at a pressure of 0.1 with acetic ether of the same pressure, the absorption of the latter would be more than 17,500 times as great as that of the former.

The absorption by the infinitesimally small quantity of matter constituting a perfume can never be measured; though Tyndall found that the odours from the essential oils exercised a marked influence on radiant heat. Perfectly dry air was allowed to pass through a tube containing dried paper impregnated with various essential oils, and then admitted into the experimental tube. Taking the absorption of dry air as unity, the following were the numbers respectively obtained for air scented with various oils:—Patchouli 31, otto of roses 37, lavender 60, thyme 68, rosemary 74, cassia 109, aniseed 372. Thus the perfume of a flower-bed absorbs a large percentage of the heat of low refrangibility emitted from it.

Ozone prepared by electrolysis of water was also found to have a remarkable absorptive effect. The small quantity of ozone present in electrolytic oxygen was found in one experiment to exercise 136 times the absorption of the entire mass of the oxygen itself.

But the most important results which Tyndall has obtained are those which follow from his experiments on the behaviour of aqueous vapour to radiant heat. The experimental tube was filled with air, dried as perfectly as possible, and the absorption it exercised was found to be one unit. Exhausting the tube, and admitting the ordinary undried, but not specially moist, air from the laboratory, the absorption now rose to 72 units. The difference between dried and undried air can only be ascribed to the aqueous vapour the latter contains. Thus on a day of average humidity the absorptive effect due to the transparent aqueous vapour present in the atmosphere is 72 times as great as that of the air itself, though in quantity the latter is about 200 times greater than the former. Analogous results were obtained on different days, and with specimens of air taken from various localities. When air which had been specially purified was allowed to pass through a tube filled with fragments of moistened glass and examined, it was found to exert an absorption 90 times that of pure air.

In some other experiments Tyndall suppressed the use of rock-salt plates in his experimental tube, and even the tube itself, and yet in every case the results were such as to show the great power which aqueous vapour possesses as an absorbent of radiant heat.

The absorptive action which the aqueous vapour in the atmosphere exerts on the sun's heat has been established by a series of actinometrical observations made by Soret at Geneva and on the summit of Mont Blanc; he finds that the intensity of the solar heat on the top of Mont Blanc is  $\frac{6}{8}$ ths of that at Geneva; in other words, that of the heat which is radiated at the height of Mont Blanc, about  $\frac{1}{8}$ th is absorbed in passing through a vertical layer of the atmosphere 14 436 feet in thickness. The same observer has found that with virtually equal solar heights there is the smallest transmission of heat on those days on which the tension of aqueous vapour is greatest, that is, when there is most moisture in the atmosphere.

429. **Radiating power of gases.**—Tyndall also examined the *radiating* power of gases. A red-hot copper ball was placed so that the current of heated air which rose from it acted on one face of a thermo-pile; this action

was compensated by a cube of hot water placed in front of the opposite face. On then allowing a current of dry olefiant gas from a gasholder to stream through a ring burner over the heated ball and thus supplant the ascending current of hot air, it was found that the gas radiated energetically. By comparing in this manner the action of many gases it was discovered that, as is the case with solids, those gases which are the best absorbers are also those which radiate most freely.

432. **Dynamic radiation and absorption.**—To another class of phenomena which Tyndall discovered he gives the name, *dynamic radiation and absorption*.

A gas when permitted to enter an exhausted tube is heated in consequence of the collision of its particles against the sides of the vessel ; it thus becomes a source of heat, which is perfectly capable of being measured. Tyndall calls this *dynamic heating*. In like manner, when a tube full of gas or vapour is rapidly exhausted, a chilling takes place owing to the loss of heat in the production of motion ; this he calls *dynamic chilling or absorption*.

He could thus determine the radiation or absorption of a gas without any source of heat external to the gas itself. An experimental tube was taken, one end of which was closed with a polished metal plate, and the other with a plate of rock salt ; in front of the latter was the face of the pile. The needle being at zero, and the tube exhausted, a gas was allowed quickly to enter until the tube was full, the effect on the galvanometer being noted. This being only a transitory effect the needle soon returned to zero ; the tube was then rapidly pumped out, by which a sudden chilling was produced, and the needle exhibited a deflection in the opposite direction.

Comparing in this way the dynamic heating and chilling of various gases, it was found that those gases which are the best absorbers are in like manner the best radiators.

Metallic surfaces when polished are, as we have seen (413), bad radiators, but radiate freely when covered with varnish. Now Tyndall made the curious experiment of varnishing a metallic surface by a film of gas. A Leslie's cube was placed with its polished metal side in front of the pile, and its effect neutralised by a second cube placed before the other face of the pile. On allowing a stream of olefiant or coal gas to flow from a gasholder over the metallic face of the first cube, a copious radiation from that side was produced as long as the flow of gas continued. Acting on the principle indicated in the foregoing experiment, Tyndall determined the dynamic radiation and absorption of vapours. The experimental tube containing a vapour under a small known pressure, air was allowed to enter until the pressure inside the tube was the same as that of the atmosphere. In this way the entering air, by its impact against the tube, became heated ; and its particles mixing with those of the minute quantity of vapour present, each of them became, so to speak, coated with a layer of the vapour. The entering air was in this case a source of heat, just as in the above experiments the Leslie's cube was. Here, however, one gas varnished another ; the radiation and subsequently the absorption of various vapours could thus be determined.

It was found that vapours differed very materially in their power of



radiating under these circumstances : of those which were tried bisulphide of carbon vapour was the worst and boracic ether the best radiator. And in all cases those which were the best absorbents were also the best radiators. By this method Tyndall was able to observe a definite radiative power with the more powerful vapours when the quantity present was immeasurably small.

431. **Relation of absorption to molecular state.**—Up to a recent period it was considered that the absorption of heat was mainly dependent upon the physical condition of the body examined. This led to the belief that it was impossible for substances of such tenuity as gases and vapours to absorb any sensible amount of heat ; and that the absorption by bodies when in a liquid state would be unlike the same bodies when solid ; moreover, that if all solid bodies were reduced to an equally fine state of division, the present differences in their absorbent and radiative powers would disappear. A few experiments made by Melloni on atmospheric air supported the first idea, and a series of experiments by Masson and Courtepee established the belief in the last. But Tyndall's researches revealed the powerful absorption of heat by various gases and vapours, and we shall now briefly show that his researches have overthrown the last two conclusions, giving us an insight into the cause of the absorption of heat which before was unattainable.

After the examination of the absorption of heat by vapours, Tyndall tried the same substances in a liquid form. The conditions of the experiments were in both cases the same ; the source of heat was always a spiral of platinum heated to redness by an electric current of known strength ; and plates of rock salt were invariably employed to contain both vapours and liquids. Finally, the absorption by the vapours was re-measured ; in this case introducing into the experimental tube, not, as before, equal quantities of vapour, but amounts proportional to the density of the liquid. When this last condition had been attained, it was found that the order of absorption by a series of liquids, and by the same series when turned into vapour, was precisely the same. Thus the substances tried stood in the following order as liquid and as vapour, beginning with the feeblest absorbent, and ending with the most powerful :—

Liquids	Vapours
Bisulphide of carbon . . . . .	Bisulphide of carbon.
Chloroform . . . . .	Chloroform.
Iodide of ethyl . . . . .	Iodide of ethyl.
Benzole . . . . .	Benzole.
Ether . . . . .	Ether.
Alcohol . . . . .	Alcohol.
Water.	

A direct determination of the proportional amount of the vapour of water could not be made, on account of the lowness of its tension, and the hygroscopic nature of the plates of the rock salt. But the remarkable and undeviating regularity of the absorption by all the other substances in the list, when as liquid and vapour, establishes the fact, which is corroborated by the experiments already mentioned, that aqueous vapour is one of the most energetic absorbents of heat.

In this table it will be noticed that those substances which have the simplest chemical constitution stand first in the list, with one anomalous exception, namely that of water. In the absorption of heat by gases, Tyndall found that the elementary gases were the feeblest absorbents, while the gases of most complex constitution were the most powerful absorbers. Thus it may be inferred that absorption is mainly dependent on chemical constitution; that is to say, that absorption and radiation are molecular acts independent of the physical condition of the body.

But this conclusion appeared to be contradicted by the experiments of Masson and Courtepeé on powders. Tyndall repeated these experiments, avoiding certain sources of error into which the French experimenters had fallen, and discovered that the radiation of powders is similar to that of the solids from which they were derived, and therefore differs greatly *inter se*. The absorbent power of powders was also found to correspond with their radiative power—as we have shown to be the case with solids and gases, and, though as yet we have no experiments on the subject, is doubtless also true for liquids. The powders were attached to the tin surfaces of a Leslie's cube, in such a manner that radiation took place from the surface of the powder alone. The following table gives the radiation in units from some of the powders examined by Tyndall; the metal surface of the cube giving a deflection of 15 units:—

*Radiation from powders.*

Rock salt . . . . .	35·3	Sulphate of calcium . . . . .	77·7
Biniodide of mercury . . . . .	39·7	Red oxide of iron . . . . .	78·4
Sulphur . . . . .	40·6	Hydrated oxide of zinc . . . . .	80·4
Carbonate of calcium . . . . .	70·2	Sulphide of iron . . . . .	81·7
Red oxide of lead . . . . .	74·0	Lampblack . . . . .	84·0

These substances are of various colours. Some are white, such as rock salt, carbonate and sulphate of calcium, and hydrated oxide of zinc; some are red, such as biniodide of mercury and oxide of lead; whilst others are black, as sulphide of iron and lampblack: we have besides other colours. The colours, therefore, have no influence on the radiating power: rock salt for example, is the feeblest radiator, and hydrated oxide of zinc one of the most powerful radiators.

Nearly a century ago Franklin made experiments on coloured pieces of cloth, and found their absorption, indicated by their sinking into snow on which they were placed, to increase with the darkness of the colour. But all the cloths were equally powerful absorbents of obscure heat, and the effects noticed were only produced by their relative absorptions of light. In fact, the conclusions to be drawn from Franklin's experiment only hold good for luminous heat, especially sunlight, such as he employed.

**432. Applications.**—The properties which bodies possess of absorbing, emitting, and reflecting heat, meet with numerous applications in domestic economy and in the arts. Leslie stated in a general manner that white bodies reflect heat very well, and absorb very little, and that the contrary is the case with black substances. As we have seen, this principle is not

generally true, as Leslie supposed ; for example, for non-luminous rays white lead has as great an absorbing power as lampblack (424). Leslie's principle applies to powerful absorbents like cloth, cotton, wool, and other organic substances when exposed to luminous heat. Accordingly, the most suitable coloured clothing for summer is just that which experience has taught us to use, namely, white, for it absorbs less of the sun's rays than black clothing, and hence feels cooler.

The polished fire-irons before a fire are cold, whilst the black fender is often unbearably hot. If, on the contrary, a liquid is to be kept hot as long as possible, it must be placed in a brightly polished metallic vessel, for then, the emissive power being less, the cooling is slower. It is for this reason advantageous that the steam pipes, etc., of locomotives should be kept bright.

In the Alps, the mountaineers accelerate the fusion of the snow by covering it with earth, which increases the absorbing power.

In our dwellings, the outsides of the stoves and of hot-water apparatus ought to be black, and the insides of fire-places ought to be lined with fire-brick, in order to increase the radiating power towards the apartment.

It is in consequence of the great diathermancy of dry atmospheric air that the higher regions of the atmosphere are so cold, notwithstanding the great heat which traverses them : whilst the intense heat of the sun's direct rays on high mountains is probably due to the comparative absence of aqueous vapour at those high elevations.

As nearly all the luminous rays of the sun pass through water, and the sun's radiation as we receive it on the surface of the earth consisting of a large proportion of luminous rays, accidents have often arisen from the convergence of these luminous rays by bottles of water which act as lenses. In this way gunpowder could be fired by the heat of the sun's rays concentrated by a water lens ; and the drops of water on leaves in greenhouses have, it is said, been found to act as lenses, and burn the leaves on which they rest.

Certain bodies can be used (422) to separate the heat and light radiated from the same source. Rock salt covered with lampblack, or still better with iodine, transmits heat, but completely stops light. On the other hand, alum, either as a plate or in solution, or a thin layer of water, is permeable to light, but stops all the heat from obscure sources. This property is made use of in apparatus which are illuminated by the sun's rays, in order to sift the rays of their heating power ; and a vessel full of water, or a solution of alum, is used with the electric light when it is desirable to avoid too intense a heat.

In gardens, the use of shades to protect plants depends partly on the diathermancy of glass for heat from luminous rays and its athermancy for obscure rays. The heat which radiates from the sun is largely of the former quality, but by contact with the earth it is changed into obscure heat, which as such cannot retrace the glass. This explains the manner in which greenhouses accumulate their warmth, and also the great heat experienced in summer in rooms having glass roofs, for the glass in both cases effectually entraps the solar rays. On the same principle plates of glass are frequently used as screens to protect us from the heat of a fire ; the glass allows us to

see the cheerful light of the fire, but intercepts the larger part of the heat radiated from the fire. Though the screens thus become warm by the heat they have absorbed, yet as they radiate this heat in all directions, towards the fire as well as towards us, we finally receive less heat when they are interposed.

433. **Attraction and repulsion arising from radiation.**—Crookes has discovered a highly remarkable class of phenomena which are due to the radiant action of heated and of luminous bodies. These phenomena are most conveniently illustrated by means of an instrument which he has devised and which is called the *radiometer*, the construction of which is as follows. A glass tube, (fig. 341) with a bulb blown on it, is fused at the bottom to a glass tube which at one end serves to rest the whole apparatus in a wooden support. In the other end is fused a fine steel point. On this rests a small vane or fly consisting of four arms of aluminium wire fixed at one end to a small cap, while at the others are fixed small discs or lozenges of thin mica, coated on one side with lamp-black. The weight of the fly is not more than two grains.

In order to keep the fly on the pivot a tube is fused in the upper part of the bulb which reaches down to and just surrounds the top of the cap without, however, touching it; the other end of this tube is drawn out and connected with an arrangement for exhausting the air by the Sprengel pump or by chemical means; when the desired degree of exhaustion has been attained this can be sealed. By keeping the apparatus during exhaustion in a hot-air bath at a temperature of  $300^{\circ}$ , the gases occluded on the inner surface of the glass and by the vanes are got rid of.

If a source of light or of heat, a candle for instance, is brought near the fly, it is attracted, and the fly rotates slowly in a direction indicating that the blackened side moves towards the light; this movement indicating an attraction depends on a certain state of rarefaction. If, however, the apparatus be connected with an arrangement which allows the pressure to be varied, as the air within is further rarefied this rotation gradually diminishes in rapidity until a certain point is reached at which it ceases. If now the rarefaction is pushed further, the highly remarkable phenomenon is observed that repulsion succeeds to attraction, and that the fly now rotates



Fig. 341.

in the direction of the blackened sides away from the source of heat. In a double radiometer, in which two flys are pivoted independently one over the other, having their blackened sides opposite each other, on the approach of a lighted candle the flys rotate in opposite directions. When a cold body is brought near instead of a hot one—a piece of ice, for instance—exactly the opposite effects are observed; when the vessel contains air the pith ball is repelled, the neutral point is observed, and at high degrees of rarefaction attraction ensues.

One of the most important facts brought to light by these experiments is that what has hitherto been looked upon as a complete vacuum is not so in reality; the most perfect vacuum obtainable still contains a certain residue of gas, as has been proved by the experiments of Crookes and others, among whom that of Kundt may be mentioned. The latter placed on the vanes a light disc of mica, and at a little distance above it a similar disc was arranged so as to rotate freely in a horizontal plane independently of the first. When the lower vane was made to rotate by bringing a light near, it was found that the upper disc was also put in rotation in the same direction, being dragged by the viscosity of the residual air. Accordingly the explanation of the phenomena of the radiometer must take into account the existence of this gaseous residue.

The nature of the gas seems to have no special influence on the phenomena; whether the vacuum be one of hydrogen, of aqueous vapour, or of iodine vapour, seems immaterial; though with hydrogen the exhaustion need not be pushed so far as with air. The repulsion takes place with all the rays of the spectrum, the intensity diminishing from the ultra red to the ultra violet. When the chemical rays act, the interposition of a plate of alum has no effect, while a solution of iodine in bisulphide of carbon diminishes the repulsion. The rate at which the vane rotates depends on the intensity of the source of light. With a strong light the rotation is so rapid that its rate cannot be determined. With two candles at the same distance the rotation is twice as rapid as with one. Two sources of light which, successively placed at the same distance, produce the same rate of rotation, are equal in intensity. If, when placed at different distances, they produce the same speed of rotation, their intensities are directly as the squares of these distances from the radiometer. On this is based the use of the instrument as a photometer (495) for comparing together various sources of artificial light. It may also be used for making comparative measurements of the intensity of sunlight.

It is not difficult to understand that the attraction observed in the experiments, as long as the apparatus still contains air, may be explained by the action of convection currents. For heat falling upon this blackened disc would raise its temperature, and the temperature of a layer of air in immediate contact with the disc would be raised too, it would expand and rise, flowing over into the space behind the disc, and increase the pressure there.

On the other hand the repulsion observed at the higher degrees of exhaustion approaching a vacuum is explained by reference to the modern views as to the constitution of gases, of which it is at once an illustration and a proof.

The general nature of this theory is that a gas is an assemblage of independent molecules, which are perfectly elastic, and which move with great rapidity; their impacts against the sides of the vessel in which the gas is contained are the cause of the pressure. The impact of the molecules against each other is the mechanism by which the equal transmission of pressure in gases is effected (284).

Crookes has calculated that the mechanical effect of the force of repulsion is equal to about the  $\frac{1}{100}$  of a milligramme on a square centimetre, and Stoney has shown that this force is sufficient to account for the effects observed by reference to admitted principles of the mechanical theory of gases.

The rays of heat pass through the thin glass without raising its temperature, and, falling on the blackened side of the vane, are absorbed by it; the consequence of this is that it will become slightly hotter. The layer of extremely rarefied air in immediate contact with the blackened disc will also become somewhat hotter, and the molecules will fly from the disc with greater velocity. Under ordinary pressures or even at moderate degrees of rarefaction these more rapid motions would be equalised by their impacts against other molecules, and a uniformity of pressure, that is of temperature, would be established. But the frequency of these intramolecular shocks diminishes rapidly with the increase of rarefaction, and the consequence is that a great number of molecules, after having been heated by contact with the blackened side of the palette, will strike against the cold glass. The effect of this will be to cool these molecules, that is, to diminish their velocity; it will be chiefly molecules of this kind which fall on the back of the disc, and on the regions behind it. An excess of force equal and opposite to that on the glass, acts against the front of the disc, and is sufficient to account for the phenomena exhibited by Mr. Crookes.

It follows from this explanation that, other things being equal, a fly will rotate more rapidly in a small than in a large bulb. This has been conclusively proved by Crookes, who constructed a double bulb radiometer, the two bulbs being very different in size, and so connected that by dextrous manipulation the fly could be transferred from the pivot of the one to that of the other bulb.

**433a. Internal friction or viscosity of gases.**—In some recent experiments in connection with the radiometer, Crookes used an arrangement consisting of a long but light arm of straw suspended by a delicate glass fibre in a sort of T tube turned upside down; in this way even a greater degree of delicacy was obtained than with the radiometer. Thus he was able to get a deflection by moonlight, which does not move the fly of the radiometer. He examined the internal friction or viscosity of the residual gas by causing the arm to oscillate, and then observing the rate at which the oscillations diminish under various pressures. He thus found that from ordinary pressures down to a pressure of  $0.19^{\text{mm}}$ , or what may be called a Torricellian vacuum, the viscosity is practically constant, only diminishing from  $0.126$  to  $0.112$ . It now begins to fall off, and at a pressure of  $0.000076^{\text{mm}}$  it has diminished to  $0.01$  or about  $\frac{1}{12}$ th. Simultaneously with this decrease in viscosity the force of repulsion excited by a standard light on a blackened surface varies. It increases as the pressure diminishes until the exhaustion is about  $0.05^{\text{mm}}$ , and attains its maximum at about  $0.03^{\text{mm}}$ . It then sinks

very rapidly until it is at  $0.000076^{\text{mm}}$ , when it is less than one-tenth of its maximum.

The viscosity varies in different gases; it is considerably less in hydrogen than in air; and hence it is not necessary to drive the exhaustion so far to produce a considerable degree of repulsion.

## CHAPTER IX.

### CALORIMETRY.

**434. Calorimetry. Thermal unit.**—The object of calorimetry is to measure the *quantity of heat* which a body parts with or absorbs when its temperature sinks or rises through a certain number of degrees, or when it changes its condition.

Quantities of heat may be expressed by any of its directly measurable effects, but the most convenient is the alteration of temperature, and quantities of heat are usually defined by stating the extent to which they are capable of raising a known weight of a known substance, such as water. The unit chosen for comparison, and called the *thermal unit*, is not everywhere the same. In France it is the quantity of heat necessary to raise the temperature of *one* kilogramme of water through *one* degree Centigrade; this is called a *calorie*. In this book we shall adopt, as a thermal unit, *the quantity of heat necessary to raise one pound of water through one degree Centigrade*: 1 *calorie* = 2.2 thermal units, and 1 thermal unit = 0.45 *calorie*.

On the centimetre-gramme-second system of units the heat required to raise one gramme of water through one degree is taken as the unit.

**435. Specific heat.**—When equal weights of two different substances, at the same temperature, placed in similar vessels, are subjected for the same length of time to the heat of the same lamp, or are placed at the same distance in front of the same fire, it is found that their temperatures will vary considerably; thus mercury will be much hotter than water. But as, from the conditions of the experiment, they have each been receiving the same amount of heat, it is clear that the quantity of heat which is sufficient to raise the temperature of mercury through a certain number of degrees will only raise the temperature of the same quantity of water through a less number of degrees; in other words, that it requires more heat to raise the temperature of water through one degree than it does to raise the temperature of mercury by the same extent. Conversely, if the same quantities of water and of mercury at  $100^{\circ}$  C. be allowed to cool down to the temperature of the atmosphere, the water will require a much longer time for the purpose than the mercury: hence, in cooling through the same number of degrees, water gives out more heat than does mercury.

It is readily seen that all bodies have not the same specific heat. If a pound of mercury at  $100^{\circ}$  is mixed with a pound of water at zero, the temperature of the mixture will only be about  $3^{\circ}$ . That is to say, that while the mercury has cooled through  $97^{\circ}$ , the temperature of the water has only been raised  $3^{\circ}$ . Consequently the same weight of water requires about 32 times as much heat as mercury does to produce the same elevation of temperature.

If similar experiments are made with other substances it will be found that the quantity of heat required to effect a certain change of temperature is different for almost every substance, and we speak of the *specific heat* or *calorific capacity* of a body as the quantity of heat which it absorbs when its temperature rises through a given range of temperature, from zero to  $1^{\circ}$  for example, compared with the quantity of heat which would be absorbed under the same circumstances, by the same weight of water; that is water is taken as the standard for the comparison of specific heats. Thus, to say that the specific heat of lead is  $0.0314$ , means that the quantity of heat which would raise the temperature of any given weight of lead through  $1^{\circ}$  C. would only raise the temperature of the same weight of water through  $0.0314^{\circ}$  C.

Temperature is the *vis viva* of the smallest particles of a body; in bodies of the same temperature the atoms have the same *vis viva*, the smaller mass of the lighter atoms being compensated by their greater velocity. The heat absorbed by a body not only raises its temperature, that is increases the *vis viva* of the progressive motion of the atoms, but in overcoming the attraction of the atoms it moves them further apart, and along with the expansion which this represents, some external pressure is overcome. In the conception of specific heat is included, not merely that amount of heat which goes to raise the temperature, but also that necessary for the internal work of expansion, and that required for the external work. If these latter could be separated we should get the true *heat of temperature*, that which is used solely in increasing the *vis viva* of the atoms. This is sometimes called the *true specific heat*.

Three methods have been employed for determining the specific heats of bodies: (i.) the method of the melting of ice, (ii.) the method of mixtures and (iii.) that of cooling. In the latter, the specific heat of a body is determined by the time which it takes to cool through a certain temperature. Previous to describing these methods, it will be convenient to explain the expression for the quantity of heat absorbed or given out by a body of known weight and specific heat, when its temperature rises or falls through a certain number of degrees.

**436. Measure of the sensible heat absorbed by a body.**—Let  $m$  be the weight of a body in pounds,  $c$  its specific heat, and  $t$  its temperature. The quantity of heat necessary to raise a pound of water through one degree being taken as unity,  $m$  of these units would be required to raise  $m$  pounds of water through one degree, and to raise it through  $t$  degrees,  $t$  times as much, or  $mt$ . As this is the quantity of heat necessary to raise through  $t$  degrees  $m$  pounds of water whose specific heat is unity, a body of the same weight, only of different specific heat, would require  $mtc$ . Consequently, when a body is heated through  $t$  degrees, the quantity of heat which it absorbs is the *product of its weight into the range of temperature into its specific heat*. This principle is the basis of all the formulæ for calculating specific heats.

If a body is heated or cooled from  $t$  to  $t'$  degrees, the heat absorbed or disengaged will be represented by the formula

$$m(t' - t)c, \text{ or } m(t - t')c.$$

**437. Method of the fusion of ice.**—This method of determining specific heats is based on the fact that to melt a pound of ice 80 thermal units are



necessary, or more exactly 79·25. Black's calorimeter (fig. 342) consists of a block of ice in which a cavity is made, and which is provided with a cover of ice. The substance whose specific heat is to be determined is heated to a certain temperature, and is then placed in the cavity, which is covered. After some time the body becomes cooled to zero. It is then opened, and both the substance and the cavity wiped dry with a sponge which has been previously weighed. The increase of weight of this sponge obviously represents the ice which



Fig. 342.

has been converted into water.

Now, since one pound of ice at  $0^\circ$  in melting to water  $0^\circ$  absorbs 80 thermal units,  $P$  pounds absorbs  $80P$  units. On the other hand this quantity of heat is equal to the heat given out by the body in cooling from  $t^\circ$  to zero, which is  $mtc$ , for it may be taken for granted that in cooling from  $t^\circ$  to zero a body gives out as much heat as it absorbs in being heated from zero to  $t^\circ$ . Consequently from

$$mtc = 80P \text{ we have } c = \frac{80P}{mt}$$

It is difficult to obtain blocks of ice as large and pure as those used by



Fig. 343.



Fig. 344.

Black in his experiments, and Lavoisier and Laplace have replaced the block of ice by a more complicated apparatus, which is called the *ice calorimeter*. Fig. 343 gives a perspective view of it, and fig. 344 represents a section. It consists of three concentric tin vessels; in the central one is placed the body  $M$ , whose specific heat is to be determined, while the two others are filled with pounded ice. The ice in the compartment  $A$  is melted by the heated body, while the ice in the compartment  $B$  cuts

off the heating influence of the surrounding atmosphere. The two stopcocks  $E$  and  $D$  give issue to the water which arises from the liquefaction of the ice.

In order to find the specific heat of a body by this apparatus, its weight  $m$  is first determined; it is then raised to a given temperature,  $t$ , by keeping it for some time in an oil or water bath, or in a current of steam. Having been quickly brought into the central compartment, the lids are replaced and covered with ice, as represented in the figure. The water which flows out by the stopcock  $D$  is collected. Its weight,  $P$ , is manifestly that of the melted ice. The calculation is then made as in the preceding case.

There are many objections to the use of this apparatus. From its size

it requires some quantity of ice, and a body, *M*, of large mass ; while the experiment lasts a considerable time. A certain weight of the melted water remains adhering to the ice, so that the water which flows out from *D* does not exactly represent the weight of the melted ice.

438. **Bunsen's ice calorimeter.**—On the very considerable diminution of volume which ice experiences on passing into water (335), Bunsen has based a calorimeter which is particularly suited when only small quantities of a substance can be used in determinations. A small test tube *a* (fig. 345) intended to receive the substance experimented upon is fused in the wider tube *B*. The part *ab* contains pure freshly boiled-out distilled water, and the prolongation of this tube *BC* together with the capillary tube *d*, contains pure mercury. This tube *d* is firmly fixed to the end of the tube *C* ; it is graduated, and the value of each division of the graduation is specially determined by calibration. When the apparatus is immersed in a freezing mixture, the water in the part *ab* freezes. Hence, if afterwards, while the apparatus is protected against the access of heat from without, a weighed quantity of a substance at a given temperature is introduced into the tube, it imparts its heat to this in sinking to zero. In doing so it melts a certain quantity of ice, which is evidenced by a corresponding depression of the mercury in the tube *d*. Thus the weight of ice melted, together with the weight and original temperature of the substance experimented upon, furnish all the data for calculating the specific heat.



Fig. 345.

For this mode of determining the specific heat a new determination of the latent heat of ice was made, and was found to be 80.025. It was also in connection with these experiments that Bunsen made his determination of the specific gravity of ice, which he found to be in the mean 0.91674.

By the above method Bunsen determined the specific heat of several of the rare metals for which a weight of only a few grains could be used.

439. **Method of mixtures.**—In determining the specific heat of a solid body by this method, it is weighed and raised to a known temperature, by keeping it, for instance, for some time in a closed place heated by steam ; it is then immersed in a mass of cold water, the weight and temperature of which are known. From the temperature of the water after mixture the specific heat of the body is determined.

Let *M* be the weight of the body, *T* its temperature, *c* its specific heat ; and let *m* be the weight of the cold water, and *t* its temperature.

As soon as the heated body is plunged into the water, the temperature of the latter rises until both are at the same temperature. Let this temperature be  $\theta$ . The heated body has been cooled by  $T - \theta$  ; it has, therefore, lost a quantity of heat,  $M(T - \theta)c$ . The cooling water has, on the contrary, absorbed a quantity of heat equal to  $m(\theta - t)$ , for the specific heat of water is unity. Now the quantity of heat given out by the body is manifestly equal to the quantity of heat absorbed by the water ; that is,  $M(T - \theta)c = m(\theta - t)$ , from which

$$c = \frac{m(\theta - t)}{M(T - \theta)}$$

An example will illustrate the application of this formula. A piece of iron weighing 60 ounces, and at a temperature of  $100^{\circ}$  C., is immersed in 180 ounces of water, whose temperature is  $19^{\circ}$  C. After the temperatures have become uniform, that of the cooling water is found to be  $22^{\circ}$  C. What is the specific heat of the iron?

Here the weight of the heated body  $M$  is 60, the temperature  $T$  is  $100^{\circ}$ ,  $c$  is to be determined; the temperature of mixture,  $\theta$ , is  $22^{\circ}$ , the weight of the cooling water is 180, and its temperature  $19^{\circ}$ . Therefore

$$c = \frac{180(22 - 19)}{60(100 - 22)} = \frac{9}{78} = 0.1153.$$

440. **Corrections.**—The vessel containing the cooling water is usually a small cylinder of silver or brass, with thin polished sides, and is supported by some badly conducting arrangement. It is obvious that this vessel, which is originally at the temperature of the cooling water, shares its increase of temperature, and in accurate experiments this must be allowed for. The decrease of temperature of the heated body is equal to the increase of temperature of the cooling water, and of the vessel in which it is contained. If the weight of this latter be  $m'$ , and its specific heat  $c'$ , its temperature, like that of the water, is  $t$ : consequently the previous equation becomes

$$Mc(T - \theta) = m(\theta - t) + m'c'(\theta - t);$$

from which, by obvious transformations,

$$c = \frac{(m + m'c')(\theta - t)}{M(T - \theta)}.$$

Generally speaking, the value  $m'c'$  is put  $=\mu$ ; that is to say,  $\mu$  is the weight of water which would absorb the same quantity of heat as the vessel. This is said to be the *reduced value* in water of the vessel, or the *water equivalent*. The expression accordingly becomes

$$c = \frac{(m + \mu)(\theta - t)}{M(T - \theta)}.$$

In accurate experiments it is necessary also to allow for the heat absorbed by the glass and mercury of the thermometer, by introducing into the equation their values reduced on the same principle.

In order to allow for the loss of heat due to radiation, a preliminary experiment is made with the body whose specific heat is sought, the only object of which is to ascertain approximately the increase of temperature of the cooling water. If this increase be  $10^{\circ}$ , for example, the temperature of the water is reduced by half this number—that is to say  $5^{\circ}$  below the temperature of the atmosphere—and the experiment is then carried out in the ordinary manner.

By this method of compensation, first introduced by Rumford, the water receives as much heat from the atmosphere during the first part of the experiment as it loses by radiation during the second part.

441. **Regnault's apparatus for determining specific heats.**—Fig. 346 represents one of the forms of apparatus used by M. Regnault in determining specific heats by the method of mixtures.

The principal part is a water-bath, AA, of which fig. 347 represents a section. It consists of three concentric compartments; in the central one

there is a small basket of brass wire, *c*, containing fragments of the substance whose specific heat is to be determined, in the middle of which is placed a thermometer, *T*. The second compartment is heated by a current of steam coming through the tube, *e*, from a boiler, *B*, and passing into a worm, *a*, where it is condensed. The third compartment, *ii*, is an air chamber, to hinder the loss of heat. The water bath *AA* rests on a chamber, *K*, with double sides,

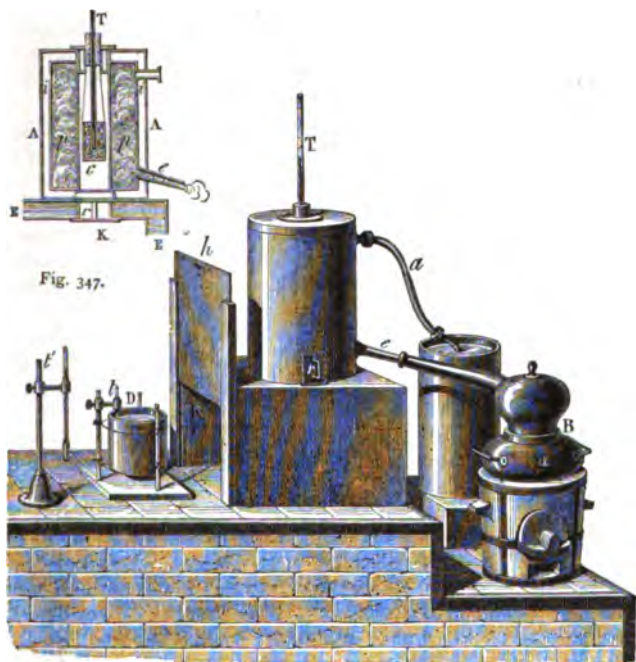

Fig. 346.

*EE*, forming a jacket, which is kept full of cold water, in order to exclude the heat from *AA* and from the boiler *B*. The central compartment of the water bath is closed by a damper *r*, which can be opened at pleasure, so that the basket *c* can be lowered into the chamber *K*.

On the left of the figure is represented a small and very thin brass vessel *D*, suspended by silk threads on a small carriage, which can be moved out of, or into, the chamber *K*. This vessel which serves as a calorimeter, contains water, in which is immersed a thermometer, *l*. Another thermometer at the side, *l'*, gives the temperature of the air.

When the thermometer *T* shows that the temperature of the substance in the bath is stationary, the screen *h* is raised, and the vessel *D* moved to just below the central compartment of the water bath. The damper *r* is then withdrawn, and the basket *c* and its contents are lowered into the water of the vessel *D*, the thermometer *T* remaining fixed in the cork. The carriage and the vessel *D* are then moved out, and the water agitated until

the thermometer T becomes stationary. The temperature which it indicates is  $\theta$ . This temperature known, the rest of the calculation is made in the manner described in art. 440, care being taken to make all the necessary corrections.

In determining the specific heat of substances—phosphorus, for instance—which could not be heated without causing them to melt, or undergo some change which would interfere with the accuracy of the result, Regnault adopted an inverse process: he cooled them down to a temperature considerably below that of the water in the calorimeter, and then observed the diminution in the temperature of the latter, which resulted from immersing the cooled substance in it.

In determining the specific heat of substances, which, like potassium, would decompose water, some other liquid, such as turpentine or benzole, must be used. These liquids have the additional advantage of having a lower specific heat than water, which has the highest of any liquid, so that any error in determining the temperature of the cooling liquid has a less influence on the value of the specific heat. With this view use has been made of mercury, the specific heat of which is only one-thirtieth that of water.

**442. Method of cooling.**—Equal weights of different bodies whose specific heats are different, will occupy different times in cooling through the same number of degrees. Dulong and Petit have applied this principle in determining the specific heats of bodies in the following manner: A small polished silver vessel is filled with the substance in a state of fine powder, and a thermometer placed in the powder, which is pressed down. This vessel is heated to a certain temperature, and is then introduced into a copper vessel, in which it fits hermetically. This copper vessel is exhausted, and maintained at the constant temperature of melting ice, and the time noted which the substance takes in falling through a given range of temperature, from  $15^{\circ}$  to  $5^{\circ}$  for example. The times which equal weights of different bodies require for cooling through the same range of temperature are directly as their specific heats.

Regnault has proved that with solids this matter does not give trustworthy results; it assumes, which is not quite the case, that the cooling in all parts is equal, and that all substances part with their heat to the silver case with equal facility. The method may, however, be employed with success in the determination of the specific heat of liquids.

In an investigation of the specific heats of various soils, Pfaundler found that a soil of low specific heat heats and cools rapidly, while earth of higher specific heat undergoes slow heating and slow cooling; that moist earths rich in humus have a high specific heat, amounting in the case of turf to as much as 0.5; while dry soils free from humus, such as lime and sand, have a low specific heat, not more than about 0.2.

**443. Specific heat of liquids.**—The specific heat of liquids may be determined either by the method of cooling, by that of mixtures, or by that of the ice calorimeter. In the latter case they are contained in a small metal vessel, or a glass tube, which is placed in the central compartment (fig. 316), and the experiment then made in the usual manner.

It will be seen from the following table that water and oil of turpentine have a much greater specific heat than other substances, and more

especially than the metals. It is from its great specific heat that water requires a long time in being heated or cooled, and that for the same weight and temperature it absorbs or gives out far more heat than other substances. This double property is applied in the hot-water apparatus, of which we shall presently speak, and it plays a most important part in the economy of nature.

444. *Specific heats of bodies.*—The list contained in the next article (§ 445) gives the specific heats of a great number of elementary substances, principally from Regnault's determinations. We give here the specific heats of a few substances, mostly liquids—

	Specific heat		Specific heat
Turpentine . . . . .	0·426	Bisulphide of carbon . . . . .	0·245
Alcohol . . . . .	0·062	Thermometer glass . . . . .	0·198
Ether . . . . .	0·516	Steel . . . . .	0·118
Glycerine . . . . .	0·555	Brass . . . . .	0·094

These numbers, as well as the numbers in 445, represent the mean specific heats between  $0^{\circ}$  and  $100^{\circ}$ . It was, however, shown by Dulong and Petit that the specific heats increase with the temperature. Those of the metals, for instance, are greater between  $100^{\circ}$  and  $200^{\circ}$  than between  $0^{\circ}$  and  $100^{\circ}$ , and are still greater between  $200^{\circ}$  and  $300^{\circ}$ . That is to say, a greater amount of heat is required to raise a body from  $200^{\circ}$  to  $250^{\circ}$ , than from  $100^{\circ}$  to  $150^{\circ}$ , and still more than from  $0^{\circ}$  to  $50^{\circ}$ . For silver, the mean specific heat between  $0^{\circ}$  and  $100^{\circ}$  is 0·057, while between  $0^{\circ}$  and  $200^{\circ}$  it is 0·0611. The following table gives the specific heats at various temperatures :—

Copper . . . . .	0·0910 + 0·000046 <i>t</i>
Zinc . . . . .	0·0865 + 0·000088 <i>t</i>
Lead . . . . .	0·0286 + 0·000038 <i>t</i>
Platinum . . . . .	0·0329 + 0·000042 <i>t</i>
Water . . . . .	1 + 0·00022 <i>t</i>

The increase of specific heat with the temperature is greater as bodies are nearer their fusing point. Any action which increases the density and molecular aggregation of a body, diminishes its specific heat. The specific heat of copper is diminished by its being hammered, but it regains its original value after the metal has been again heated.

The specific heat of a liquid increases with the temperature much more rapidly than that of a solid. Water is, however, an exception; its specific heat increases less rapidly than does that of solids.

The most remarkable examples of the influence of temperature on the specific heat are afforded by carbon, boron, and silicon. Weber has found that at  $600^{\circ}$  the specific heat of carbon is 7 times, and that of boron  $2\frac{1}{2}$  times as great as their respective specific heats at  $-50^{\circ}$ . The specific heat of diamond is 0·0635 at  $-50^{\circ}$ , 0·1318 at  $33^{\circ}$ , 0·2218 at  $140^{\circ}$ , and 0·3026 at  $247^{\circ}$ . Although the specific heat increases then rapidly between  $-50^{\circ}$  and  $250^{\circ}$ , beyond that point the rate of increase is slower, and beyond  $600^{\circ}$ , or at an incipient red heat, it seems to be pretty constant, or at any rate to exhibit no greater variations with the temperature than are afforded by other substances. Thus, while at  $600^{\circ}$  the specific heat is 0·441, at  $985^{\circ}$  it is 0·459. Graphite also has at  $22^{\circ}$  the specific heat 0·168; this increases, but at a gradually diminishing

rate, to  $642^{\circ}$ , where its specific heat is  $0.445$ . Like diamond, an incipient red heat seems to be a limiting temperature beyond which graphite exhibits only the ordinary variation with the temperature. Weber has also found that, in their thermal deportment, there are only two essentially different modifications of carbon; the transparent one (diamond), and the opaque ones (graphite, dense amorphous carbon, and porous amorphous carbon).

Crystallised boron is similar in its deportment to carbon; its specific heat increases from  $0.1915$  at  $-40^{\circ}$  to  $0.2382$  at  $27^{\circ}$ , and to  $0.3663$  at  $233^{\circ}$ . The rate of increase is very rapid up to  $80^{\circ}$ ; it increases beyond that temperature but at a gradually diminished rate, and, no doubt, tends to an almost constant value of  $0.5$ .

The specific heat of silicon also varies with the temperature; between  $-40^{\circ}$  and  $200^{\circ}$  it increases from  $0.136$  to  $0.203$ ; the rate of increase is less rapid with higher temperatures, being at  $200^{\circ}$  only  $\frac{1}{14}$  what it is at  $10^{\circ}$ . At  $200^{\circ}$  it reaches its limiting value.

The specific heat of substances is greater in the liquid than in the solid state, as will be seen by the following table:—

	Solid	Liquid
Water . . . . .	0.489	1.000
Bromine . . . . .	0.084	0.110
Mercury . . . . .	0.031	0.033
Phosphorus . . . . .	0.190	0.202
Tin . . . . .	0.056	0.064
Lead . . . . .	0.031	0.040

It also differs with the allotropic modification; thus the specific heat of red phosphorus is  $0.19$  and that of white  $0.17$ ; of crystallised arsenic  $0.083$ , and of amorphous  $0.058$ ; of crystallised selenium  $0.084$ , and of amorphous  $0.0953$ ; of wood charcoal  $0.241$ ; of graphite  $0.202$ ; and of diamond  $0.147$ .

Pouillet used the specific heat of platinum for measuring high degrees of heat. Supposing 200 ounces of platinum had been heated in a furnace, and had then been placed in 1000 ounces of water, the temperature of which it had raised from  $13^{\circ}$  to  $20^{\circ}$ . From the formula we have  $M = 200$ ,  $m = 1000$ ;  $\theta$  is 20, and  $t$  is 13. The specific heat of platinum is  $0.033$ , and we have, therefore, from the equation,

$$T = \frac{Mc(T - \theta) + m(\theta - t)}{Mc} = \frac{7000 + 132}{6.6} = \frac{7132}{6.6} = 1080^{\circ}.$$

It is found, however, that the specific heat of platinum at temperatures of about 1000 is  $0.0371$ ; if this value, therefore, be substituted for  $c$  in the above equation,

$$T = \frac{7152.2}{7.46} = 963^{\circ} \text{ C.}$$

By this method, which requires great skill in the experimenter, Pouillet determined a series of high temperatures. He found, for example, the temperature of melting iron to be  $1500^{\circ}$  to  $1600^{\circ}$  C.

**445. Dulong and Petit's law.**—A knowledge of the specific heat of bodies has become of great importance, in consequence of Dulong and Petit's

discovery of the remarkable law, that the product of the specific heat of any solid element into its atomic weight is approximately a constant number, as will be seen from the following table :—

	Specific heat	Atomic weight	Atomic heat
Aluminum . . . . .	0·2143	27·4	5·87
Antimony . . . . .	0·0513	122	6·26
Arsenic . . . . .	0·0822	75	6·17
Bismuth . . . . .	0·0308	210	6·47
Bromine . . . . .	0·0843	80	6·74
Cadmium . . . . .	0·0567	112	6·35
Cobalt . . . . .	0·1067	58·7	6·26
Copper . . . . .	0·0939	63·5	5·99
Gold . . . . .	0·0324	197	6·38
Iodine . . . . .	0·0541	127	6·87
Iron . . . . .	0·1138	56	6·37
Lead . . . . .	0·0314	207	6·50
Magnesium . . . . .	0·2475	24	5·94
Mercury . . . . .	0·0332	200	6·64
Nickel . . . . .	0·1092	58·7	6·41
Phosphorus . . . . .	0·1740	31·0	5·39
Platinum . . . . .	0·0324	197·5	6·40
Potassium . . . . .	0·1655	39·1	6·47
Silver . . . . .	0·0570	108·0	6·16
Sulphur . . . . .	0·178	32	5·70
Tin . . . . .	0·0555	118	6·55
Zinc . . . . .	0·0956	65·2	6·23

It will be seen that the number is not a constant, varying as it does between 5·39 and 6·87. These variations may depend partly on the difficulty of getting the elements in a state of perfect purity, and partly on errors incidental to the determination of the specific heats, and of the atomic weights. Again, the specific heats of bodies vary with the state of aggregation of the bodies, and also with the temperatures at which they are determined ; some, such as potassium, have been determined at temperatures very near their fusing points, others like platinum at temperatures much removed from them. A main cause, therefore, of the discrepancies is doubtless to be found in the fact that the determinations have not been made under corresponding physical conditions.

According to modern views, the heat imparted to a body is partly expended in external work, which in the case of a solid would be extremely small, being only that required for the pressure of the atmosphere raised through a distance representing the expansion ; secondly, the internal work, or the heat used in overcoming the attraction of the atoms, and forcing them apart, and thirdly there is the *true specific heat*, or the heat applied in increasing the temperature, that is, in increasing the *vis viva* of the molecules (435). By far the most considerable of these is the latter ; the amount of heat consumed in the two former operations is very small, and the variations with different bodies must be inconsiderable. Until, however, the relation



between the various factors is made out, absolute identity in the number for the atomic specific heat cannot be expected. Weber holds that even when due allowance has been made for these circumstances, the variations are too great to be accounted for, and he considers that they point for their explanation to an alteration in the constitution of the atom, and render probable a changing valency of the atom of carbon.

The atomic weights of the elements represent the relative weights of equal numbers of atoms of these bodies, and the product,  $pc$ , of the specific heat  $c$  into the atomic weight  $p$  is the *atomic heat*, or the quantity of heat necessary to raise the temperature of the same number of atoms of different substances by one degree; and Dulong and Petit's law may be thus expressed: *the same quantity of heat is needed to heat an atom of all simple bodies to the same extent.*

The atomic heat of a body, when divided by its specific heat, gives the atomic weight of a body. Regnault has even proposed to use this relation as a means of determining the atomic weight, and it certainly is of great service in deciding on the atomic weight of a body in cases where the chemical relations permit a choice between two or more numbers.

In compound bodies the law also prevails: the product of the specific heat into the equivalent is an almost constant number, which varies, however, with different classes of bodies. Thus, for the class of oxides of the general formula  $RO$ , it is 11.30; for the sesquioxides  $R^2O^3$ , it is 27.15; for the sulphides  $RS$ , it is 18.88; and for the carbonates  $RCO^3$ , it is 21.54. The law may be expressed in the following general manner:—*With compounds of the same formula, and of a similar chemical constitution, the product of the atomic weight into the specific heat is a constant quantity.* This includes Dulong and Petit's law as a particular case.

446. **Specific heat of compound bodies.**—In order to deduce the specific heat of the compound from that of its elements, Wæstyn has made the following hypothesis: he assumes that an element, in entering into combination with others to form a compound body, retains its own specific heat, so that if  $p, p', p'', \dots$  represent the atomic weights of the elements, and  $P$  that of the compound;  $c, c', c'', \dots$  C, the corresponding specific heats, while  $n, n', n'', \dots$  are the numbers of atoms of these simple bodies which make up the molecule of the compound, the relation obtains:

$$PC = npc + n'p'c' + n''p''c'' + \dots$$

Wæstyn has found that the results obtained by calculating, on this hypothesis, the specific heats of the sulphides, iodides, and bromides agree with experimental results.

447. **Specific heat of gases.**—The specific heat of a gas may be referred either to that of water or to that of air. In the former case, it represents the quantity of heat necessary to raise a given weight of the gas through one degree, as compared with the heat necessary to raise the same weight of water one degree. In the latter case it represents the quantity of heat necessary to raise a given volume of the gas through one degree, compared with the quantity necessary for the same volume of air treated in the same manner.

De la Roche and Berard determined the specific heats of gases in reference to water by causing known volumes of a given gas under constant pressure, and at a given temperature, to pass through a spiral glass tube placed in water. From the increase in temperature of this water, and from the other data, the specific heat was determined by a calculation analogous to that given under the method of mixtures. The same physicists also determined the specific heats of different gases relatively to that of air, by comparing the quantities of heat which equal volumes of a given gas, and of air at the same pressure and temperature, imparted to equal weights of water. Subsequently to these researches, De la Rive and Marcet have applied the method of cooling to the same determination; and still more recently Regnault has made a series of investigations on the calorific capacities of gases and vapours, in which he has adopted, but with material improvements, the method of De la Roche and Berard. He has thus obtained the following results for the specific heats of the various gases and vapours, compared first with an equal weight of water taken as unity; secondly, with that of an equal volume of air, referred, as before, to its own weight of water taken as unity.

		Specific weights	
		Equal weights	Equal volumes
Simple gases	Air . . . . .	0·2374	0·2374
	Oxygen . . . . .	0·2175	0·2405
	Nitrogen . . . . .	0·2438	0·2370
	Hydrogen . . . . .	3·4090	0·2359
	Chlorine . . . . .	0·1210	0·2962
Compound gases	Binoxide of nitrogen . . . . .	0·2315	0·2406
	Carbonic oxide . . . . .	0·2450	0·2370
	Carbonic acid . . . . .	0·2163	0·3307
	Hydrochloric acid . . . . .	0·1845	0·2133
	Ammonia . . . . .	0·5083	0·2966
	Olefiant gas . . . . .	0·4040	0·4106
Vapours	Water . . . . .	0·4805	0·2984
	Ether . . . . .	0·4810	1·2296
	Alcohol . . . . .	0·4534	0·7171
	Turpentine . . . . .	0·5061	2·3776
	Bisulphide of carbon . . . . .	0·1570	0·4140
	Benzole . . . . .	0·3754	1·0114

In making these determinations the gases were under a constant pressure, but variable volume; that is, the gas as it was heated could expand, and this is called the *specific heat under constant pressure*. But if the gas when being heated is kept at a constant volume, its pressure or elastic force then necessarily increasing, it has a different capacity for heat; this latter is spoken of as the *specific heat under constant volume*. That this latter is less than the former is evident from the following considerations.

Suppose a given quantity of gas to have had its temperature raised  $t^\circ$ , while the pressure remained constant, this increase of temperature will have been accompanied by a certain increase in volume. Supposing now that the gas is so compressed as to restore it to its original volume, the result of

this compression will be to raise its temperature again to a certain extent, say  $t''$ . The gas will now be in the same condition as if it had been heated, and not been allowed to expand. Hence, the same quantity of heat which is required to raise the temperature of a given weight of gas,  $t''$ , while the pressure remains constant and the volume alters, will raise the temperature  $t + t''$  degrees if it is kept at a constant volume but variable pressure. The specific heat, therefore, of a gas at constant pressure,  $c_p$ , is greater than the specific heat under constant volume,  $c_v$ , and they are to each other as  $t + t'' : t$ , that is  $\frac{c_p}{c_v} = \frac{t + t''}{t}$ .

It is not possible to determine by direct means the specific heat of gases under constant volume with much approach to accuracy; and it has always been determined by some indirect method, of which the most accurate is based on the theory of the propagation of sound (227). The latest determination made on this basis gives the number 1.414 for the value of  $\frac{c_p}{c_v}$ .

448. **Latent heat of fusion.**—Black was the first to observe that during the passage of a body from the solid to the liquid state, a quantity of heat disappears, so far as thermometric effects are concerned, and which is accordingly said to become latent.

In one experiment he suspended in a room at the temperature  $8.5^\circ$  two thin glass flasks, one containing water at  $0^\circ$ , and the other the same weight of ice at  $0^\circ$ . At the end of half an hour the temperature of the water had risen  $4^\circ$ , that of the ice being unchanged, and it was  $10\frac{1}{2}$  hours before the ice had melted and attained the same temperature. Now the temperature of the room remained constant, and it must be concluded that both vessels received the same amount of heat in the same time. Hence 21 times as much heat was required to melt the ice and raise it to  $4^\circ$  as was sufficient to raise the same weight of water through  $4^\circ$ . So that the total quantity of heat imparted to the ice was  $21 \times 4 = 84$ , and as of this only 4 was used in raising the temperature, the remainder, 80, was used in simply melting the ice.

He also determined the latent heat by immersing 119 parts of ice at  $0^\circ$  in 135 parts of water at  $87.7^\circ$  C. He thus obtained 254 parts of water at  $11.6^\circ$  C. Taking into account the heat received by the vessel in which the liquid was placed, he obtained the number 79.44 as the latent heat of liquidity of ice.

We may thus say ·

Water at  $0^\circ$  = Ice at  $0^\circ$  + latent heat of liquefaction.

The method which Black adopted is essentially that which is now used for the determination of latent heats of liquids; it consists in placing the substance under examination at a known temperature in the water (or other liquid) of a calorimeter, the temperature of which is sufficient to melt the substance if it is solid, and to solidify it if liquid, and when uniformity of temperature is established in the calorimeter, this temperature is determined. Thus, to take a simple case, suppose it is required to determine the latent heat of the liquidity of ice. Let  $M$  be a certain weight of ice at zero, and  $m$  a weight of water at  $t''$  sufficient to melt the ice. The ice is immersed in

the water, and as soon as it has melted the final temperature  $\theta^\circ$  is noted. The water, in cooling from  $t^\circ$  to  $\theta^\circ$ , has parted with a quantity of heat,  $m(t-\theta)$ . If  $x$  be the latent heat of the ice, it absorbs, in liquefying, a quantity of heat,  $Mx$ ; but, besides this, the water which it forms has risen to the temperature  $\theta^\circ$ , and to do so has required a quantity of heat, represented by  $M\theta$ . We thus get the equation

$$Mx + M\theta = m(t - \theta),$$

from which the value of  $x$  is deduced.

By this method Desains and De la Provostaye found that the latent heat of the liquefaction of ice is  $79\cdot25$ ; that is, a pound of ice, in liquefying, absorbs the quantity of heat which would be necessary to raise  $79\cdot25$  pounds of water  $1^\circ$ , or, what is the same thing, one pound of water from zero to  $79\cdot25^\circ$  (*vide* 438).

This method is thus essentially that of the method of mixtures; the same apparatus may be used, and the same precautions are required in the two cases. In determining the latent heat of liquidity of most solids, the different specific heats of the substance in the solid and in the liquid state require to be taken into account. In such a case, let  $m$  be the weight of the water in the calorimeter (the water equivalents of the calorimeter and thermometer supposed to be included);  $M$  the weight of the substance worked with;  $t$  the original and  $\theta$  the final temperature of the calorimeter;  $T$  the original temperature of the substance;  $\mathfrak{C}$  its melting (or freezing) point;  $C$  the specific heat of the substance in the solid state between the temperature  $\mathfrak{C}$  and  $\theta$ ;  $c$  its specific heat in the liquid state between the temperatures  $T$  and  $\mathfrak{C}$ ; and let  $L$  be the latent heat sought.

If the experiment be made on a melted substance which gives out heat to the calorimeter and is thereby solidified (it is taken for granted that a body gives out as much heat in solidifying as it absorbs in liquefying), it is plain that the quantity of heat absorbed by the calorimeter,  $m(\theta-t)$ , is made up of three parts: first, the heat lost by the substance in cooling from its original temperature  $T$  to the solidifying point  $\mathfrak{C}$ ; secondly, the heat given out in solidification,  $L$ ; and, thirdly, the heat it loses in sinking from its solidifying point  $\mathfrak{C}$  to the temperature of the water of the calorimeter. That is:

$$m(\theta-t) = M(T-\mathfrak{C})c + L + (\mathfrak{C}-\theta)C \quad ]$$

whence,

$$L = \frac{m(\theta-t)}{M} - (T-\mathfrak{C})c - (\mathfrak{C}-\theta)C.$$

Person obtained the following numbers for the latent heats of fusion of several bodies:

Water . . . . .	79·24	Bismuth . . . . .	12·64
Nitrate of sodium . . . . .	62·97	Sulphur . . . . .	9·37
Zinc . . . . .	28·13	Lead . . . . .	5·37
Silver . . . . .	21·07	Phosphorus . . . . .	5·03
Tin . . . . .	14·25	D'Arcet's alloy . . . . .	4·50
Cadmium . . . . .	13·66	Mercury . . . . .	2·83

These numbers represent the number of degrees through which a pound

of water would be raised by a pound of the body in question in passing from the liquid to the solid state : or, what is the same thing, the number of pounds of water that would be raised  $1^{\circ}$  C. by one of the bodies in solidifying.

On modern views the heat expended in melting is consumed in moving the atoms into new positions ; the work, or its equivalent in heat required for this, the potential energy they thus acquire, is strictly comparable to the expenditure of work in the process of raising a weight. When the liquid solidifies, it reproduces the heat which had been expended in liquefying the solid ; just as when a stone falls it produces by its impact against the ground the heat, the equivalent of which in work had been expended in raising it, and a similar explanation applies to the latent heat of gasification.

**449. Determination of the latent heat of vapours.**—Liquids, as we have seen, in passing into the state of vapour, absorb a very considerable quantity of heat, which is termed *latent heat of vaporisation*. In determining the heat absorbed in liquids, it is assumed that a vapour, in liquefying, gives out as much heat as it had absorbed in becoming converted into vapour.

The method employed is essentially the same as that for determining the specific heat of gases. Fig. 348 represents the apparatus used by M. Despretz. The vapour is produced in a retort, C, where its temperature is indicated by a thermometer. It passes into a worm immersed in cold water, where it condenses, imparting its latent heat to the condensing water in the vessel B. The condensed vapour is collected in a vessel, A, and its weight



Fig. 348.

represents the quantity of vapour which has passed through the worm. The thermometers in B give the change of temperature.

Let  $M$  be the weight of the condensed vapour,  $T$  its temperature on entering the worm, which is that of its boiling point, and  $x$  the latent heat of vaporisation. Similarly, let  $m$  be the weight of the condensing water (comprising the weight of the vessel B and of the worm  $SS$  reduced in water, let  $t^{\circ}$  be the temperature of the water at the beginning, and  $\theta^{\circ}$  its temperature

at the end of the experiment.

It is to be observed that, at the commencement of the experiment, the condensed vapour passes out at the temperature  $t^{\circ}$ , while at the conclusion its temperature is  $\theta^{\circ}$  ; we may, however, assume that its mean temperature during the experiment is  $\frac{(t + \theta)}{2}$ .

The vapour  $M$  after condensation has therefore parted with a quantity of heat  $M \left( T - \frac{t + \theta}{2} \right) c$ , while the heat disengaged in liquefaction is represented by  $Mx$ . The quantity of heat

absorbed by the cold water, the worm, and the vessel is  $m(\theta - t)$ . Therefore,

$$Mx + M\left(T - \frac{t + \theta}{2}\right)c = m(\theta - t),$$

from which  $x$  is obtained. M. Despretz found that the latent heat of aqueous vapour at  $100^\circ$  is 540; that is, a pound of water at  $100^\circ$  absorbs in vaporising as much heat as would raise 540 pounds of water through  $1^\circ$ . M. Regnault found the number 537, and MM. Favre and Silbermann 538.8.

As in the case of the latent heat of water we may say,

Steam at  $100^\circ$  = Water at  $100^\circ$  + latent heat of gasification.

In the conversion of a body from the liquid into the gaseous state, as in the analogous process of fusion, one part of the heat is used in increasing the temperature and another in internal work. For vaporisation the greater portion is consumed in the internal work of overcoming the reciprocal attraction of the particles of liquid, and in removing them to the far greater distances apart in which they exist in the gaseous state. In addition to this there is the external work—namely, that required to overcome the external pressure, usually that of the atmosphere; and as the increase of volume in vaporisation is considerable, this pressure has to be raised through a greater distance. Vaporisation may take place without having external work to perform, as when it is effected in vacuo; but whether the evaporation is under a high or under a low pressure, on the surface of a liquid or in the interior, there is always a great consumption of heat in internal work.

**450. Favre and Silbermann's Calorimeter.**—The apparatus (fig. 349) furnishes a very delicate means of determining the calorific capacity of liquids, latent heats of evaporation, and the heat disengaged in chemical actions.

The principal part is a spherical iron reservoir, A, full of mercury, of which it holds about 50 pounds, and represents, therefore, a volume of more than half a gallon. On the left there are two tubulures, B, in which are fitted two sheet-iron tubes or *muffles*, projecting into the interior of the bulb. Each can be fitted with a glass tube for containing the substance experimented upon. In most cases one muffle and one glass tube are enough; the two are used when it is desired to compare the quantities of heat produced in two different operations. In a third vertical tubulure, C, there is also a muffle, which can be used for determining calorific capacities by Regnault's method (441), in which case it is placed beneath the  $r$  of fig. 346.

The tubulure  $d$  contains a steel piston; a rod, turned by a handle,  $m$ , and which is provided with a screw thread, transmits a vertical motion to the piston; but, by a peculiar mechanism, gives it no rotatory motion. In the last tubulure is a glass bulb,  $a$ , in which is a long capillary glass tube,  $bo$ , divided into parts of equal capacity.

It will be seen from this description that the mercury calorimeter is nothing more than a thermometer with a very large bulb and a capillary stem: it is therefore extremely delicate. It differs, however, from a thermometer in the fact that the divisions do not indicate the temperature of the mercury in the bulb, but the number of thermal units imparted to it by the substances placed in the muffle.

This graduation is effected as follows:—By working the piston the mercury can be made to stop at any point of the tube,  $bo$ , at which it is desired the graduation should commence. Having then placed in the iron tube a small quantity of mercury, which is not afterwards changed, a thin

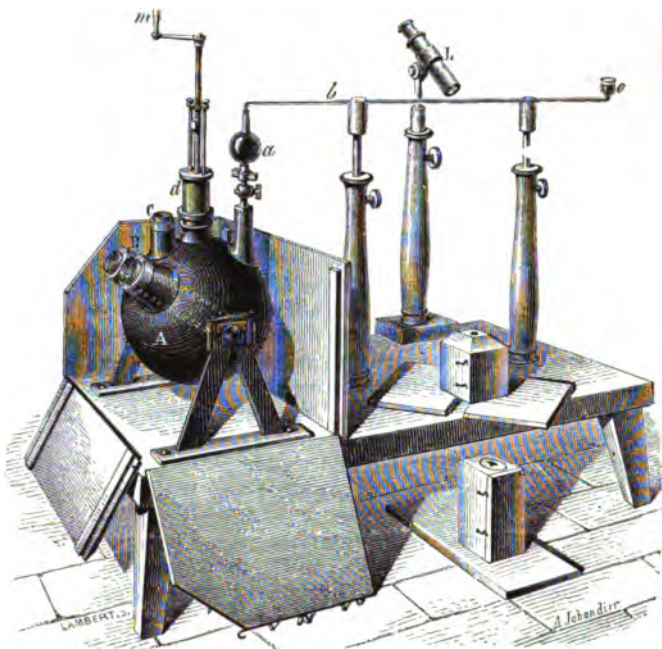

Fig. 349.

glass tube,  $e$ , is inserted, which is kept fixed against the buoyancy of the mercury by a small wedge not represented in the figure. The tube being thus adjusted, the point of a bulb tube (see fig. 350) is introduced containing water, which is raised to the boiling point: turning the position of the pipette, then, as represented on  $n'$ , a quantity of the liquid flows into the test tube.

The heat which is thus imparted to the mercury makes it expand; the column of mercury in  $bo$  is lengthened by a number of divisions, which we shall call  $n$ . If the water poured into the test glass be weighed, and if its temperature be taken when the column  $bo$  is stationary, the product of the weight of the water into the number of degrees through which it has fallen indicates the number of thermal units which the water gives up to the entire apparatus (435). Dividing by  $n$  this number of thermal units, the quotient gives the number  $a$  of thermal units corresponding to a single division of the tube  $bo$ .

In determining the specific heat of liquids, a given weight,  $M$ , of the liquid in question is raised to the temperature  $T$ , and is poured in the tube  $C$ .

Calling the specific heat of the liquid  $C$ , its final temperature  $\theta$ , and  $n$  the number of divisions by which the mercurial column  $bo$  has advanced, we have

$$Mc(T - \theta) = na, \text{ from which } c = \frac{na}{M(T - \theta)}.$$

The boards represented round the apparatus are hinged so as to form a box, which is lined with eider down or wadding to prevent any loss of heat. It is closed at the top by a board, which is provided with a suitable case, also lined, which fits over the tubulures  $d$  and  $a$ . A small magnifying glass which slides along the latter enables the divisions on the scale to be read off.

451. **Examples.**—I. What weight of ice at zero must be mixed with 9 pounds of water at  $20^\circ$  in order to cool it to  $5^\circ$ ?

Let  $M$  be the weight of ice necessary; in passing from the state of ice to that of water at zero, it will absorb  $80M$  thermal units; and in order to raise

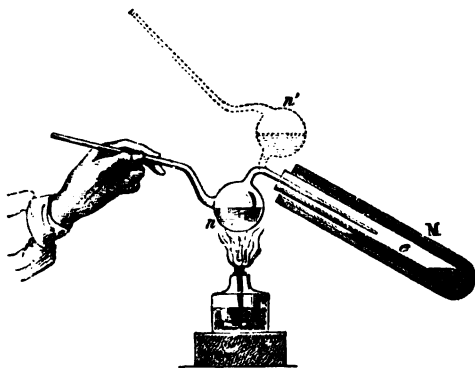

Fig. 350.

it from zero to  $5^\circ$ ,  $5M$  thermal units will be needed. Hence the total heat which it absorbs is  $80M + 5M = 85M$ . On the other hand, the heat given up by the water in cooling from  $20^\circ$  to  $5^\circ$  is  $9 \times (20 - 5) = 135$ . Consequently,

$$85M = 135; \text{ from which } M = 1.588 \text{ pounds.}$$

II. What weight of steam at  $100^\circ$  is necessary to raise the temperature of 208 pounds of water from  $14^\circ$  to  $32^\circ$ ?

Let  $p$  be the weight of the steam. The latent heat of steam is  $540^\circ$ , and consequently  $p$  pounds of steam in condensing into water give up a quantity of heat,  $540p$ , and form  $p$  pounds of water at  $100^\circ$ . But the temperature of the mixture is  $32^\circ$ , and therefore  $p$  gives up a further quantity of heat  $p(100 - 32) = 68p$ , for in this case  $c$  is unity. The 208 pounds of water in being heated from  $14^\circ$  to  $32^\circ$  absorb  $208(32 - 14) = 3744$  units. Therefore

$$540p + 68p = 3744; \text{ from which } p = 6.158 \text{ pounds.}$$



## CHAPTER X.

## STEAM ENGINES.

452. **Steam engines.**—*Steam engines* are machines in which the elastic force of aqueous vapour is used as the motive power. In the ordinary engines the alternate expansion and condensation of steam imparts to a piston an alternating rectilinear motion, which is changed into a circular motion by means of various mechanical arrangements.

Every steam engine consists essentially of two distinct parts: the apparatus in which the steam is produced, and the engine proper. We shall first describe the former.

453. **Steam boiler.**—The boiler is the apparatus in which steam is generated. Fig. 351 represents a side view, and fig. 352 a cross section of a

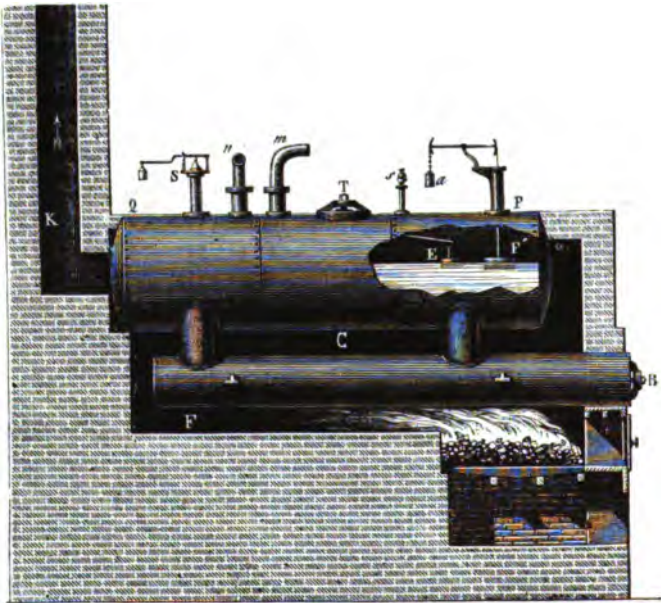

Fig. 351.

cylindrical boiler, such as are used for fixed engines; those of locomotives and of steam vessels are very different.

It is a long wrought-iron cylinder, PQ, with curved ends, beneath which there are two smaller cylinders, BB, of the same material, and communicating with the boiler by two tubes. Only one of these cylinders is represented in fig. 351. They are called *heaters*, and are quite full of water, while the boiler is only about half full.

In order to multiply the heating surface, and utilise all the heat carried off by the products of combustion, the latter are made to circulate through brick conduits which surround the sides of the heaters and of the boiler. These conduits, which are called *flues*, divide the furnace into two horizontal compartments, FF and DCD (fig. 351). The upper compartment is more-over divided into three distinct flues, D, C, D, by two vertical divisions, which are not represented in the drawing, and which correspond to the two sides of the boiler. The flame and the products of combustion, which first sweep below the heaters from back to front, return in the opposite direction by the central flue C; then, dividing, they pass by the lateral flues into the chimney K, where they are lost in the atmosphere.

*Explanation of Figures 351 and 352.*

E. Float of the safety whistle, *s*.

FF. Furnace.

F. *Float*, to show the level of the water in the boiler. It consists of a rectangular piece of stone partially immersed in water, as seen through the space which is represented as left open. This stone, which is suspended at one end of a lever, is kept poised by the loss of weight which it sustains by immersion in the water, and by a weight, *a*, at the other end of the lever. As long as the water is at the desired height, the lever which sustains the float remains horizontal; but it sinks when there is too little water, and rises in the contrary direction when there is too much. Guided by these indications, the stoker can regulate the supply of water.

K. Chimney, which has usually a great height so as to increase the draught.

S. *Safety valve* described under Papin's digester (360).

T. *Man-hole*, an aperture by which the boiler can be prepared and cleansed. This is self-closing, and consists of a cover fitting against the inside edges. It is kept in position by a screw, which also presses it strongly against the sides. Thus the greater the internal pressure, the more firmly is the cover pressed against the sides, and the more completely does it close.

*a*. Counterpoise of the float.

*m*. Tube which leads the steam to the tube *c* of the *valve chest* (fig. 353).

*n*. Tube for the admission of feed water for the boiler.

*s*. *Safety whistle*—so called because it gives a whistle when there is not enough water in the boiler—a circumstance which might produce an accident. As long as the level of the water is not too low in the boiler, the steam does not pass into the whistle; but if the level sinks below a certain

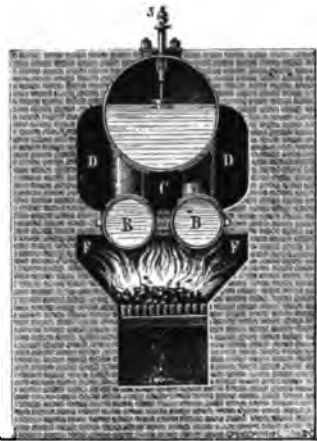

Fig. 352.

point, a small float, E, which closes the bottom of the whistle sinks, and the steam escapes ; in so doing it grazes against the edge of a thin metal plate, which it sets in vibration, and produces a sharp and loud sound. This steam whistle is the sound frequently heard upon railways ; it is used as a signal in locomotives.

454. **Double action or Watt's engine.**—In the *double acting steam engine*, the steam acts alternately above and below the piston. It is also known as *Watt's engine*, from its illustrious inventor.

We shall first give a general idea of this engine, and shall then describe each part separately. On the left of the fig. 353 is the *cylinder* which receives

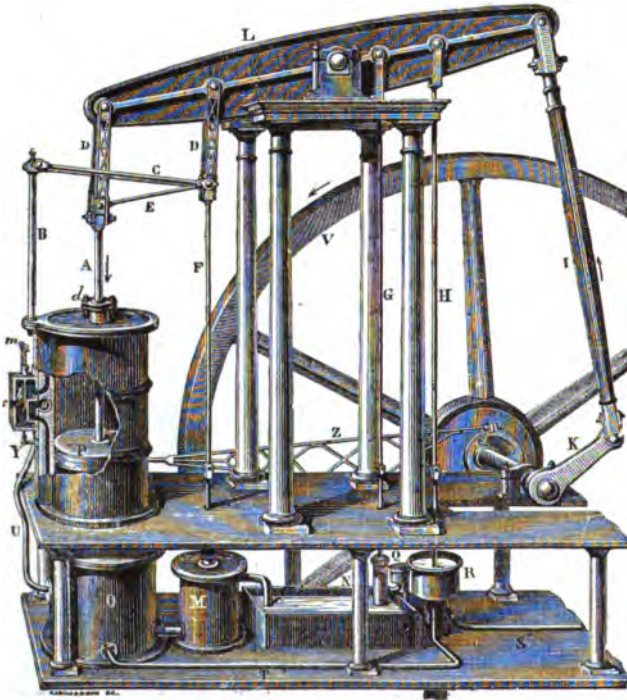

Fig. 353.

the steam from the boiler. A part of its side is represented as being left open, and a piston, P, can be seen which is moved alternately up and down by the pressure of the steam above or below the piston. By the piston rod A this motion is transmitted to a huge iron lever, L, called the *beam*, which is supported by four iron columns. The beam transmits its motion to a *connecting rod*, I, working on a crank, K, to which it imparts a continuous rotary motion. The crank is fixed to a horizontal *shaft*, which turns with it, and, by means of wheels or endless bands, this shaft sets in motion various machines, such as spinning frames, saw mills, lathes, etc.

On the left of the cylinder is a valve chest, where, by a mechanism which will presently be described, the steam passes alternately above and below the piston. Now, after its action on either face of the piston, it must disappear, for otherwise a pressure would be exerted in two opposite directions, and the piston would remain at rest. To effect this the steam, after it has acted on one side of the piston, passes into a vessel, O, called the *condenser*, into which cold water is injected. It is almost completely condensed there, and consequently the pressure ceases in that part of the cylinder which is in communication with the condenser, and as there is now pressure on only one face of the piston, it either rises or sinks.

The use of the condenser depends upon Watt's law of vapours (350), that when two vessels communicating with each other, and containing saturated vapour, are at different temperatures, the tension is the same in both vessels, and is that corresponding to the temperature of the colder vessel.

The injected water is rapidly heated by the condensation of the steam, and must be constantly renewed. This is effected by means of two pumps; one M, is called the *air pump*, and draws, from the condenser, the heated water which it contains, and also the air which was dissolved in the water of the boiler, and which passes with the steam into the cylinder and condenser; the other, R, is called the *cold water pump*, and forces cold water from a well, or from a river, into the condenser.

A third pump, Q, which is called the *feed pump*, utilises the heated water by forcing it from the condenser into the boiler.

#### *Double-acting Steam Engine.*

A. *Piston rod* connected with a parallel motion, and serving to transmit to the beam the upward and downward motion of the piston.

B. Rod fixed to the cylinder, or elsewhere, and supporting the guiding arm or radius rod, C.

C. Double guiding arm directing the parallel motion.

DDDE. Rods forming at the end of the beam a *parallel motion*, to which is fixed the piston rod, and the object of which is to guide the motion of this rod in a straight line.

F. Rod of the *air pump*, which removes from the condenser the air and heated water which it contains.

G. Rod of the *feed pump*, which forces into the boiler through the tube S the heated water pumped from the condenser.

H. Rod of the *cold water pump*, which supplies the cold water necessary for condensation.

I. *Connecting rod*, which transmits the motion of the beam to the crank.

K. *Crank*, which imparts the motion of the rod to the horizontal shaft.

L. *Beam*, which moves on an axle in its middle, and transmits the motion of the piston to the connecting rod I.

M. Cylinder of the air pump, in connection with the condenser O.

N. Reservoir for the heated water pumped by the air pump from the condenser.

O. Condenser into which cold water is injected to condense the steam after it has acted on the piston.

P. *Metal piston*, moving in a cast-iron cylinder; this piston receives the direct pressure of the steam, and transmits the motion to all parts of the machine.

Q. Feeding force pump, which sends the water into the boiler.

R. Cold water pump.

S. Pipe by which the hot water from the feed pump passes into the boiler.

T. Pipe by which cold water from the reservoir of the pump, R, passes into the condenser.

U. Pipe by which the steam from the cylinder passes into the condenser after acting on the piston.

V. Large iron wheel, called the *fly wheel*, which, by its inertia, serves to regulate the motion, especially when the piston is at the top or bottom of its course, and the crank K at its *dead points*.

Y. Bent lever which imparts the motion of the eccentric *e* to the slide valve *b*.

Z. Eccentric rod.

a. Aperture which communicates both with the upper and lower part of the cylinder, according to the position of the slide valve, and by which steam passes into the condenser through the tube U.

b. Rod transmitting motion of the *slide valve*, by which steam is alternately admitted above and below the piston. This will be described in greater detail in the next article.

c. Aperture by which steam reaches the valve chest.

d. *Stuffing box*, in which the piston rod works without giving exit to the steam.

e. *Eccentric*, fixed to the horizontal shaft, and rotating in a collar, to which the rod Z is attached.

m. Rod which connects the rod of the slide valve *b* to the bent lever Y, and to the eccentric.

The lower part of the figure does not exactly represent the usual arrangement of the pumps. The drawing has been modified in order more clearly to show how these parts work, and their connection with each other.

455. **Distribution of the steam. Eccentric.**—Fig. 354 represents the details of the *valve chest* or arrangement for the *distribution of steam*. The steam from the boiler passes by a pipe, *c*, into a cast-iron box on the side of the cylinder. In the sides of the cylinder there are three opening or *ports*, *u*, *n*, and *a*, of which *u* communicates by an internal conduit with the upper part of the cylinder, and *n* with the lower part. A slide, *t*, works over these three orifices. It is fixed to a vertical rod, *b*, which is jointed at *m* to a larger rod, *d*, and receives an upward and downward motion from the bent lever *yoS*, attached to the eccentric rod. When the slide is at the top of its course, as shown in the figure, the steam passes through *n* into the lower part of the cylinder, while the steam cannot pass through the orifice *u*, for it is covered by the slide.

But the vapour which is above the piston passes through *u* and through *a* into the hole *r*, from which it enters the condenser. The piston is then only pressed upwards, and therefore ascends.

When the slide is at the bottom of its course, the steam enters the cylinder by the aperture *u*, and passes from the lower part of the cylinder into the condenser by *n* and *a*. The piston consequently descends, and this motion goes on for each displacement of the slide.

The upward and downward motion of the slide is effected by means of the *eccentric*. This is a circular piece, E, fixed to the horizontal shaft, A,

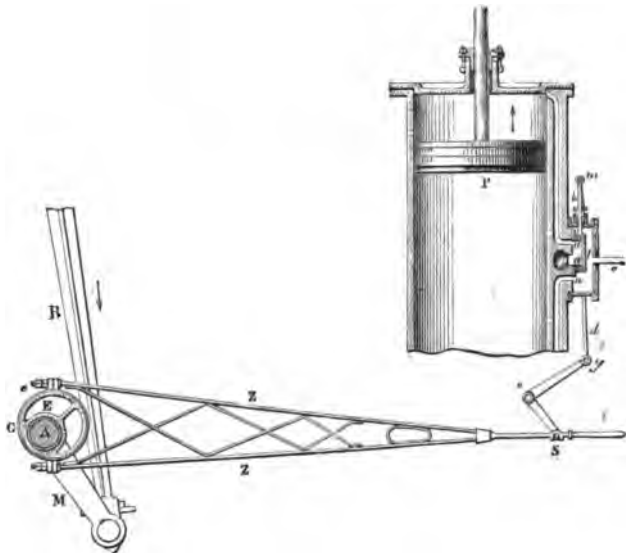

Fig. 354.

but in such a manner that its centre does not coincide with the axis of this shaft. The eccentric works with gentle friction in a collar, C, to which the rod ZZ is fixed. The collar, without rotating, follows the motion of the eccentric, and receives an alternating motion in a horizontal direction, which it communicates to the lever *Soy*, and from thence to the slide.

456. **Single-acting engine.**—In a *single-acting engine* the steam only acts on the upper face of the piston; a counterpoise fixed to the other end of the beam makes the piston rise. These engines were first constructed by Watt for pumping water from mines, and are still used for this purpose in Cornwall, and also for the supply of water to towns. They are preferred for these purposes from their simplicity, but for other purposes they have been superseded by the double-acting engine.

Fig. 355 represents a section. The beam BB is of wood, with wooden segments at each end, to which chains are attached. One of these chains is connected with the piston P, and the other with the pump Q. On the right of the cylinder A is a valve chest, C, into which steam passes from the boiler by the tube T. There are three valves, *m*, *n*, and *o*, on a vertical rod. The valves *m* and *o* open upwards, the valve *n* downwards.

When *m* and *o* are open, as shown in the drawing, the steam passes

through the tube T, over the piston, while the steam which is below is forced into the condenser through the tube M. The piston therefore descends. The rod, on which are the valves *m*, *n*, and *o*, is connected with a bent lever, *dck*, moving on a joint *c*. This bent lever closes and opens the valves. For this purpose there are two catches, *b* and *a*, on a rod, F, connected with the beam, by means of which the rod works against the end

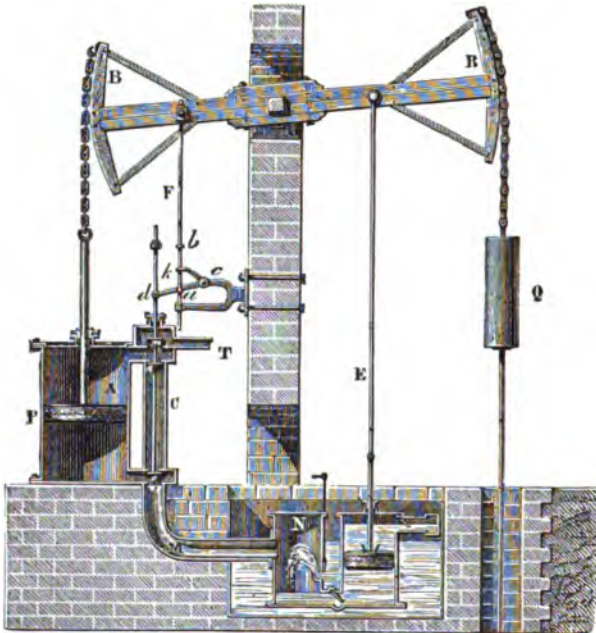

Fig. 355.

of the bent lever. From the arrangement of the valves, as represented in the drawing, the piston sinks and carries with it the rod F, and, consequently, the catch strikes against the lever, and makes it sink at the same time as the rod *dmo*; the valves *m* and *o* then close, while *n* opens.

The communication with the boiler as well as with the condenser is now cut off, and the steam which has made the piston sink passes below by the pipe C. As it presses equally on both faces, the piston would remain at rest, but it rises in consequence of the traction of the weight Q. Very little force is necessary for this; for the pump, the rod of which is fixed to the weight Q, only requires power when its piston rises. When the piston P is at the top of its course, the catch *a* strikes in turn against the lever *k*, raises the rod *dmo*, the steam again passes to the top of the piston, which again descends, and so on.

**457. Locomotives.**—*Locomotive engines*, or simply *locomotives*, are steam-engines which, mounted on a carriage, propel themselves by transmitting their motion to wheels.

The parallel motion, the beam, and the fly wheel form no part of a locomotive. The principal parts are the *framework*, the *fire box*, the *casing* of the boiler, the *smoke box*, the *steam cylinders*, with their valves, the *driving wheels*, and the *feed pump*.

The framework is of oak, and rests on the axles of the wheels. Fig. 356 represents the driver of the locomotive in the act of opening the regulator valve I, placed in the upper part of the *steam dome*. In the lower part of this is the fire box, from whence the flame and the products of combustion pass into the smoke box, Y, and then into the chimney Q, after having previously traversed 125 brass *fire tubes* which pass through the boiler. The boiler, which connects the fire box with the smoke box, is made of iron, and is cylindrical. It is cased with staves of mahogany, which, being a bad conductor, prevents its cooling too rapidly. The steam passes from the boiler into two cylinders, placed on either side of the smoke box. There, by means of a steam chest similar to that already described, it acts alternately on the two faces of the piston, the motion of which is transmitted to the axle of the large driving wheels. This arrangement of the slide valve is not seen in the drawing, because it is placed under the frame between the two cylinders. After having acted on the pistons, the steam is forced through the blast pipe E into the chimney, thus increasing the draught.

The motion of the pistons is transmitted to the two large driving wheels by two connecting rods, which, by means of cranks, connect the piston rods with the axles of the wheels. The alternating motion of the slide valve is effected by means of eccentrics placed on the axles of the large wheels.

The feeding or supply of water to the boiler is obtained by means of two pumps, placed under the frame, and moved by eccentrics. These pumps suck the water from a reservoir placed on the *tender*, which is a carriage attached to the locomotive for carrying the necessary water and coal.

#### *Explanation of Figure 356.*

A. Copper tube, into which steam passes by the extremity I, and which, dividing at the other end into two branches, conveys the steam to the two cylinders which contain the pistons.

B. Handle of the lever by which the motion is reversed. It imparts motion to a rod, C, which communicates with the steam chest.

C. Rod by which the motion is reversed.

D. Lower part of the fire box and ash pan.

E. Escape pipe for the steam after acting on the pistons.

F. Iron cylinder containing a piston, P. There is one of these on each side of the engine, and the one in front is represented as being left open in order that the piston may be seen.

G. Rod which opens the regulator valve I, in order to allow the steam to pass into the tube A. In the drawing the driver holds in his hand the lever which moves this rod.

H. Cock for blowing off water from the boiler.

I. Regulator valve, which is opened and closed by hand, so as to regulate the quantity of steam passing into the cylinders.



K. Large rod connecting the head of the piston rod with the crank M of the driving wheel. L. Lamp. M. Crank, which transmits the motion of the piston to the axle of the large wheel. N. Coupling iron, by which the tender is attached. O. Fire door. P. Metallic piston, the rod of which is

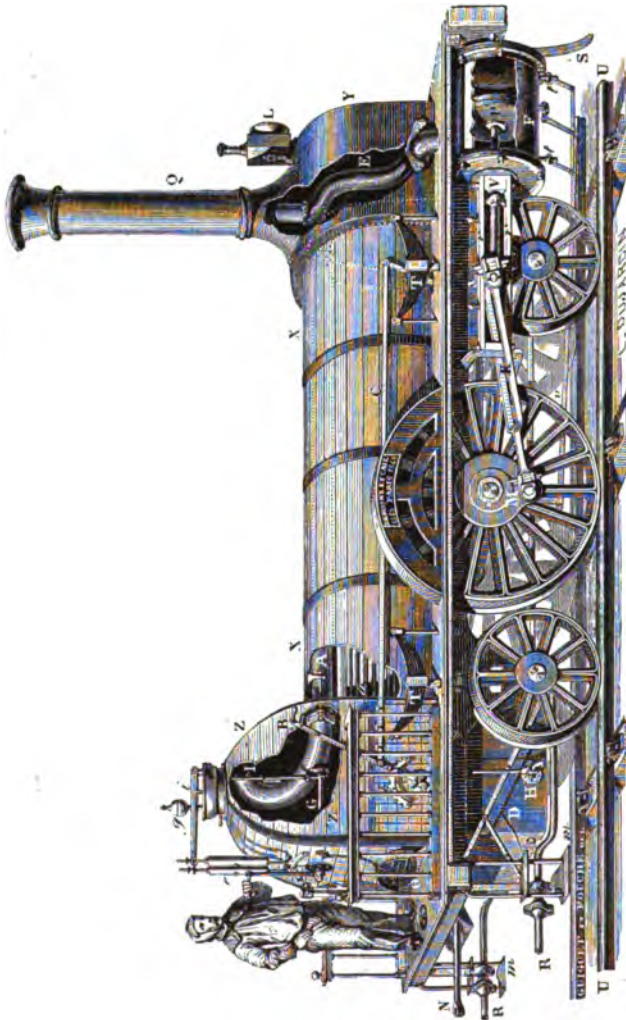

Fig. 356.

connected with the rod K. Q. Chimney. R, R. Feed pipes, through which the water in the tender passes to two force pumps, which are not shown in the drawing.

S. Guard for removing obstructions on the rails. T, T. Springs on which

the engine rests. U, U. Iron rails fixed in chairs on wooden sleepers. V. Frame of the stuffing box of the cylinder.

X, X. Cylindrical boiler, covered with mahogany staves, which, from their bad conductivity, hinder the loss of heat. The level of the water is just below the tube A. In the water are the tubes *a*, through which the smoke and flames pass into the smoke box. Y. Smoke box in which the fire tubes *a* terminate. Z, Z. Fire box, covered by a dome, into which the steam passes.

*a*. Brass tubes, of which there are 125, open at both ends, and terminating at one end in the fire box, and at the other in the smoke box. These tubes transmit to the water the heat of the fire.

*bb*. Toothed segment, placed on the side of the fire box, and in which the arm of the lever B works. When the handle is pushed forward or pulled back as far as it can go, the engine is in full forward or backward gear respectively; the intermediate teeth give various rates of expansion in backward and forward motion, the middle tooth being a dead point.

*e*. Cases containing springs by which the safety valves *i* are regulated. *g*. Signal whistle. *i*. Safety valves. *m, m*. Steps. *n*. Glass tube, showing the height of water in the boiler. *r, r*. Guiding rods, for keeping the motion of the pistons in a straight line. *t, t*. Blowing-off taps, for use when the pistons are in motion. *v*. Rod by which motion is transmitted to these taps.

458. **Reaction machines. Mollipyle.**—In *reaction machines* steam acts by a reactive force like water in a hydraulic tourniquet (213). The idea of

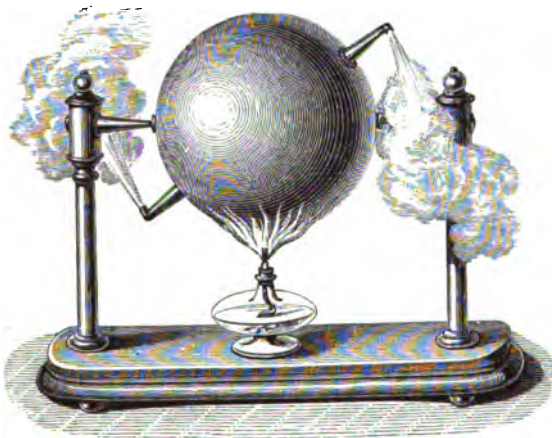

Fig. 357.

these machines is by no means new; Hero of Alexandria, who invented the fountain which bears his name, described the apparatus which is represented in fig. 357, known as the reaction machine.

It consists of a hollow metal sphere which rotates on two pivots. At the ends of a diameter are two tubulures, pierced laterally in opposite directions by orifices through which vapour escapes. Water is introduced into this apparatus by heating it, and then allowing it to cool in cold water. If the apparatus be then heated to boiling, the vapour disengaged imparts to it a rotatory motion, which is due to the pressure of the vapour on the side opposite to that from which it escapes.

Numerous attempts have been made to use this reactive force of the vapour on a large scale as a motive force, and endeavours have also been made to cause steam to act by impulse by directing a jet of steam on the float board of a paddle wheel; but in both cases the steam exerts by no means so great an effect as is obtained when it acts by expansion on a piston.

459. **Various kinds of steam engines.**—A *low-pressure engine* is one in which the pressure of the vapour does not much exceed an atmosphere; and a *high-pressure engine* is one in which the pressure of the steam usually exceeds this amount considerably. Low-pressure engines are mostly *condensing engines*; in other words, they generally have a condenser where the steam becomes condensed after having acted on the piston; on the other hand, *high-pressure engines* are frequently without a condenser; the locomotive is an example.

If the communication between the cylinder and boiler remains open during the whole motion of the piston, the steam retains essentially the same elastic force, and is said to act *without expansion*; but if, by a suitable arrangement of the slide valve, the steam ceases to pass into the cylinder when the piston is at  $\frac{2}{3}$  or  $\frac{3}{4}$  of its course, then the vapour *expands*; that is to say, in virtue of its elastic force, which is due to the high temperature, it still acts on the piston and causes it to finish its course. Hence a distinction is made between *expanding* and *non-expanding* engines.

460. **Work of an engine. Horse-power.**—The work of an engine is measured by the

Mean pressure on piston  $\times$  area of piston  $\times$  length of stroke.

In England the unit of work is the *foot-pound*; that is, the work performed in raising a weight of one pound through a height of a foot. Thus, to raise a weight of 14 pounds through a height of 20 feet would require 280 foot-pounds. In France the *kilogrammetre* is used; that is, the work performed in raising a kilogramme through a metre. This unit corresponds to 7·233 foot-pounds.

The *rate of work* in machines is the amount of work performed in a given time; a second or an hour, for example. In England the rates of work are compared by means of *horse-power*, which is a conventional unit, and represents 550 foot-pounds in a second. In France a similar unit is used called the *cheval vapeur*, which represents the work performed in raising 75 kilogrammes through one metre in a second. It is equal to about 542 foot-pounds per second.

Suppose, for instance, that a steam-engine works under a pressure of  $1\frac{1}{2}$  atmospheres, the pressure in the condenser being  $\frac{1}{2}$  an atmosphere. If the area of the piston is 50 square inches, the length of the stroke 21 inches, and the number of up and down strokes 60 in a minute; then, taking an

atmosphere as representing 14 pounds on a square inch, we shall have  $14 \times 50 \times 1.75 \times 120 = 147,000$  foot-pounds in a minute.

The useful effect of a machine is only about 0.5 to 0.7 of the theoretical effect as thus calculated, the rest is consumed in the unavoidable friction of the machine, in working the pumps, etc. If in our case we allow  $\frac{4}{10}$  for this loss we shall have 88,200 foot-pounds in a minute as the available useful effect = 1,470 foot-pounds in a second, or nearly  $2\frac{3}{4}$  horse-power. If the work of a steam engine be calculated from the heat known to be produced from a given weight of fuel (470), the discrepancy is far greater. The best Cornish engines do not give more than 14 per cent of the theoretical yield of the combustible.

461. **Hirn's experiments.**—Hirn made an important series of experiments in order to determine by means of the steam-engine the mechanical equivalent of heat (483). On the one hand, steam of known temperature and pressure was allowed to act upon the steam-engine, which was one of 100 horse-power. The amount of heat contained in the steam could be readily calculated. The amount of work which the engine performed was also determined by means of a dynamometer. The steam was ultimately condensed in the condenser, and the amount of heat produced there could readily be measured by known calorimetical methods. It was found in all cases to be less than that which originally passed into the engine, and the difference represented the amount of heat which had been converted into work in the engine; in Hirn's experiments, for every unit of heat which had disappeared, 1,354 units of work had been performed—a result, considering the difficulty of the experiments, closely agreeing with the best determinations (483).

462. **Hot air and gas engines.**—Numerous attempts have recently been made to replace the expansive force of steam by that of heated air. Yet they have hitherto been unsuccessful, owing to practical difficulties; for either the temperature had to be so high that it was impossible to keep the valves and the stuffing boxes tight, or else it was necessary greatly to increase the dimensions of the cylinder, in comparison with those of steam-engines of the same power.

In gas-engines a mixture of coal gas and of atmospheric air contained in a cylinder is ignited by the electrical spark; and the expansive force of the heated gas thus produced moves the piston. As the combustion of the gaseous mixture takes place within the cylinder itself, the loss of heat is the smallest. They have, moreover, the advantage of requiring no special fire, but can be set up and worked in any space provided with gas. Yet hitherto these apparatus have only succeeded on a small scale.

## CHAPTER XI.

### SOURCES OF HEAT AND COLD.

463. **Different sources of heat.**—The following different sources of heat may be distinguished: i. the *mechanical sources*, comprising friction, percussion, and pressure; ii. the *physical sources*—that is, solar radiation, terrestrial heat, molecular actions, changes of condition, and electricity; iii. the

*chemical sources*, or molecular combinations, and more especially combustion.

In what follows it will be seen that heat may be produced by reversing its effects; as, for instance, when a liquid is solidified or a gas compressed (465); though it does not necessarily follow that in all cases the reversal of its effects causes heat to be produced—instead of it, an equivalent of some other form of energy may be generated.

In like manner heat may be caused to disappear, or cold be produced when a change such as heat can produce is brought about by other means, as when a liquid is vaporised or a solid liquefied by solution; though here also the disappearance of heat is not always a necessary consequence of the production, by other means, of changes such as might be effected by heat.

#### MECHANICAL SOURCES.

464. **Heat due to friction.**—The friction of two bodies, one against the other, produces heat, which is greater the greater the pressure and the more rapid the motion. For example, the axles of carriage wheels, by their friction against the boxes, often become so strongly heated as to take fire. By rubbing together two pieces of ice in a vacuum below zero, Sir H. Davy partially melted them. In boring a brass cannon Rumford found that the heat developed in the course of  $2\frac{1}{2}$  hours was sufficient to raise  $26\frac{1}{2}$  pounds of water from zero to  $100^{\circ}$ , which represents 2,650 thermal units (434). Mayer raised water from  $12^{\circ}$  to  $13^{\circ}$  by shaking it. At the Paris Exhibition, in 1855, Beaumont and Mayer exhibited an apparatus, which consisted of a wooden cone covered with hemp, and moving with a velocity of 400 revolutions in a minute, in a hollow copper cone, which was fixed and immersed in the water of an hermetically-closed boiler. The surfaces were kept covered with oil. By means of this apparatus 88 gallons of water were raised from 10 to  $130$  degrees in the course of a few hours.

In the case of flint and steel, the friction of the flint against the steel raises the temperature of the metallic particles which fly off heated to such an extent that they take fire in the air.

The luminosity of aerolites is considered to be due to their friction against the air, and to their condensation of the air in front of them (465), their velocity attaining as much as 150 miles in a second.

Dr. Tyndall has devised an experiment by which the great heat developed by friction is illustrated in a striking manner. A brass tube (fig. 358), about 4 inches in length and  $\frac{3}{4}$  of an inch in diameter, is fixed on a small wheel. By means of a cord passing round a much larger wheel, this tube can be rotated with any desired velocity. The tube is three parts full of water, and is closed by a cork. In making the experiment, the tube is pressed between a wooden clamp, while the wheel is rotated with some rapidity. The water rapidly becomes heated by the friction, and its temperature soon exceeding the boiling point, the cork is projected to a height of several yards by the elastic force of the steam.

465. **Heat due to pressure and percussion.**—If a body be so compressed that its density is increased, its temperature rises according as the volume diminishes. Joule has verified this in the case of water and of oil,

which were exposed to pressures of 15 to 25 atmospheres. In the case of water at  $1.2^{\circ}$  C., increase of pressure caused lowering of temperature, a result which agrees with the fact that water contracts by heat at this temperature. Similarly, when weights are laid on metallic pillars, heat is evolved, and

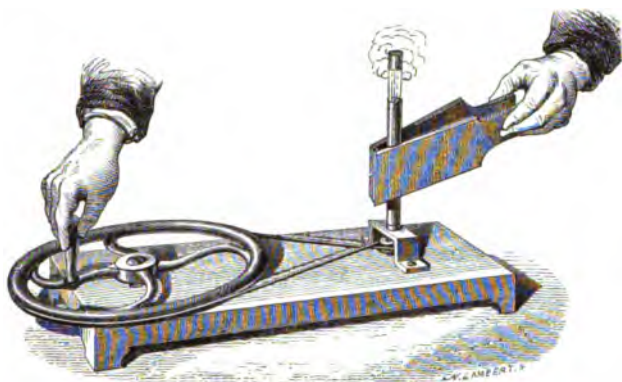

Fig. 358.

absorbed when they are removed. So in like manner the stretching of a metallic wire is attended with a diminution of temperature.

The production of heat by the compression of gases is easily shown by means of the *pneumatic syringe* (fig. 359). This consists of a glass tube with thick sides, closed hermetically by a leather piston. At the bottom of this there is a cavity in which a small piece of cotton, moistened with ether or bisulphide of carbon, is placed. The tube being full of air, the piston is suddenly plunged downwards; the air thus compressed disengages



Fig. 359.

so much heat as to ignite the cotton, which is seen to burn when the piston is rapidly withdrawn. The inflammation of the cotton in this experiment indicates a temperature of at least  $300^{\circ}$ .

A curious application of the pneumatic syringe is met with in the American *powder ram* for pile driving. On the pile to be driven is fixed a powder mortar, above which is suspended at a suitable distance an iron rammer, shaped like a gigantic stopper, which just fits in the mortar. Gunpowder is placed in the mortar, and when the rammer is detached it falls into the

mortar, condenses the air, producing so much heat that the powder is exploded. The force of the gases projects the rammer into its original position, where it is caught by a suitable arrangement; at the same time the reaction of the mortar on the pile drives this in with far greater force than the fall of the rammer. After adding a fresh charge of powder, the rammer is again allowed to fall, again produces heat, explosion, and so forth, so that the driving is effected in a surprisingly short time.

The elevation of temperature produced by the compression in the above experiment is sufficient to effect the combination, and therefore the detonation, of a mixture of hydrogen and oxygen.

*Percussion* is also a source of heat. In firing shot at an iron target, a sheet of flame is frequently seen at the moment of impact; and Mr. Whitworth has used iron shells which are exploded by the concussion on striking an iron target. A small piece of iron hammered on the anvil becomes very hot. The heat is not simply due to an approximation of the molecules—that is, to an increase in density—but arises from a vibratory motion imparted to them; for lead, which does not increase in density by percussion, nevertheless becomes heated.

The heat due to the impact of bodies is not difficult to calculate. Whenever a body moving with a velocity  $v$  is suddenly arrested in its motion, its *vis viva* is converted into heat. This holds equally whatever be the cause to which the motion is due; whether it be that acquired by a stone falling from a height, by a bullet fired from a gun, or the rotation of a copper disc by means of a turning table. The *vis viva* of any moving body is expressed by  $\frac{mv^2}{2}$ ; or in foot-pounds by  $\frac{pv^2}{2g}$ , where  $p$  is the weight in pounds,  $v$  the velocity in feet per second, and  $g$  is about 32 (29); and if the whole of this be converted into heat, its equivalent in thermal units will be  $\frac{pv^2}{2g \times 1390}$ . Suppose, for instance, a lead ball weighing a pound be fired from a gun, and strike against a target, what amount of heat will it produce? We may assume that its velocity will be about 1,600 feet per second; then its *vis viva* will be  $\frac{1 \times 1600^2}{2 \times 32} = 40,000$  foot-pounds. Some of this will have been consumed in producing the vibrations which represent the sound of the shock, some of it also in its change of shape; but neglecting these two, as being small, and assuming that the heat is equally divided between the ball and the target, then, since 40,000 foot-pounds is the equivalent of 28.7 thermal units, the share of the ball will be 14.3 thermal units; and if, for simplicity's sake, we assume that its initial temperature is zero, then, taking its specific heat at 0.0314, we shall have

$$1 \times 0.0314 \times t = 14.3 \text{ or } t = 457^\circ,$$

which is a temperature considerably above that of the melting point of lead (327).

By allowing a lead ball to fall from various heights on an iron plate, both experience an increase of temperature which may be measured by the thermopile; and from these increases it may be easily shown that the heat

is directly proportional to the height of fall, and therefore to the square of the velocity.

By similar methods Mayer has calculated that if the motion of the earth were suddenly arrested the temperature produced would be sufficient to melt and even volatilise it; while, if it fell into the sun, as much heat would be produced as results from the combustion of 5,000 spheres of carbon the size of our globe.

#### PHYSICAL SOURCES.

466. **Solar radiation.**—The most intense of all sources of heat is the sun. Different attempts have been made to determine the quantity of heat which it emits. Pouillet, from experiments made by means of an apparatus which he calls a *pyroheliometer*, has calculated that if the total quantity of heat which the earth receives from the sun in the course of a year were employed to melt ice, it would be capable of melting a layer of ice all round the earth of 35 yards in thickness. The heat emitted by the sun is equal to that produced by the combustion of 1,500 pounds of coal in an hour on each square foot of its surface. But from the surface which the earth exposes to the solar radiation, and from the distance which separates the earth from the sun, the quantity of heat which the earth receives can only be  $\frac{1}{7,341,000,000}$  of the heat emitted by the sun.

Faraday has calculated that the average amount of heat radiated in a day on each acre of ground in the latitude of London is equal to that which would be produced by the combustion of sixty sacks of coal.

It cannot be due to a combustion, for even if the sun consisted of hydrogen, which of all substances gives the most heat in combining with oxygen, it can be calculated that the heat thus produced would not last more than 3,000 years. Another supposition is that originally put forth by Mayer, according to which the heat which the sun loses by radiation is replaced by the fall of aerolites against its surface. One class of these is what we know as *shooting stars*, which often appear in the heavens with great brilliancy, especially on August 14 and November 15; the term *meteoric stone* or aerolite being properly restricted to the bodies which fall on the earth. They are often of considerable size, and are even met with in the form of dust. Although some of the sun's heat may be restored by the impact of such bodies against the sun, the amount must be very small, for Sir W. Thomson has proved that a fall of 0.3 gramme of matter in a second on each square metre of surface would be necessary for this purpose. The effect of this would be that the mass of the sun would increase, and the velocity of the earth's rotation about the sun would be accelerated to an extent which would be detected by astronomical observations.

According to Helmholtz the heat of the sun was produced originally by the condensation of a nebulous mass and is maintained by a continuance of this contraction. A sudden contraction of the primitive nebular mass of the sun to its present volume would produce a temperature of 28 millions of degrees centigrade; and a contraction of  $\frac{1}{10000}$  of its mass would be sufficient to supply the heat radiated by the sun in 2,000 years. This amount of contraction could not be detected even by the most refined astronomical methods.



467. **Terrestrial heat.**—Our globe possesses a heat peculiar to it, which is called the *terrestrial heat*. The variations of temperature which occur at the surface gradually penetrate to a certain depth, at which their influence becomes too slight to be sensible. It is hence concluded that the solar heat does not penetrate below a certain internal layer, which is called the *layer of constant temperature*: its depth below the earth's external surface varies, of course, in different parts of the globe; at Paris it is about 30 yards, and the temperature is constant at  $11.8^{\circ}$  C.

Below the layer of constant temperature, the temperature is observed to increase, on the average,  $1^{\circ}$  C. for every 90 feet. This increase has been verified in mines and artesian wells. According to this, at a depth of 3,000 yards, the temperature of a corresponding layer would be  $100^{\circ}$ , and at a depth of 20 to 30 miles there would be a temperature sufficient to melt all substances which exist on the surface. Hot springs and volcanoes confirm the existence of this central heat.

Various hypotheses have been proposed to account for the existence of this central heat. That most usually admitted by physicists is that the earth was originally in a liquid state in consequence of the high temperature, and that by radiation the surface has gradually solidified, so as to form a solid crust. The thickness of this crust is not believed to be more than 40 to 50 miles, and the interior is probably still in a liquid state. The cooling must be very slow, in consequence of the imperfect conductivity of the crust. For the same reason the central heat does not appear to raise the temperature of the surface more than  $\frac{1}{36}$  of a degree.

468. **Heat produced by absorption and imbibition.**—Molecular phenomena, such as imbibition, absorption, capillary actions, are usually accompanied by disengagement of heat. Pouillet found that whenever a liquid is poured on a finely-divided solid, an increase of temperature is produced which varies with the nature of the substances. With inorganic substances, such as metals, the oxides, the earths, the increase is  $\frac{4}{10}$  of a degree; but with organic substances, such as sponge, flour, starch, roots, dried membranes, the increase varies from 1 to 10 degrees.

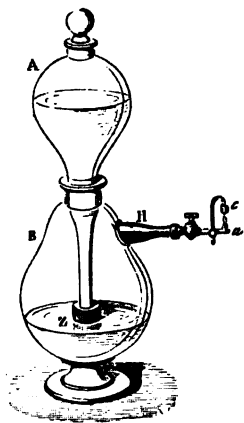

Fig. 36a.

The absorption of gases by solid bodies presents the same phenomena. Döbereiner found that when platinum, in the fine state of division known as platinum black, is placed in oxygen, it absorbs many hundred times its volume, and that the gas is then in such a state of density, and the temperature so high, as to give rise to intense combustions. Spongy platinum produces the same effect. A jet of hydrogen directed on it takes fire.

The apparatus known as *Döbereiner's Lamp* depends on this property of finely-divided platinum. It consists of two glass vessels (fig. 36a). The first, A, fits in the lower vessels by means of a tubulure which closes it hermetically. At the end of the tubulure is a mass

of zinc, Z, immersed in dilute sulphuric acid. By the chemical action of the zinc on the dilute acid hydrogen gas is generated, which, finding no issue, forces the liquid out of the vessel B into the vessel A, so that the zinc is not in contact with the liquid. The stopper of the upper vessel is raised to give exit to the air in proportion as the water rises. On a copper tube, H, fixed in the side of the vessel B, there is a small cone, E, perforated by an orifice; above this there is some spongy platinum in the capsule D. As soon now as the cock, which closes the tube H, is opened, the hydrogen escapes, and coming in contact with the spongy platinum, is ignited.

The condensation of vapours by solids often produces an appreciable increase of temperature. This is particularly the case with humus, which, to the benefit of plants, is warmer in moist air than the air itself.

M. Favre has found that when a gas is absorbed by charcoal the amount of heat produced by the absorption of a given weight of sulphurous acid, or of protoxide of nitrogen, greatly exceeds that which is disengaged in the liquefaction of the same weight of gas; for carbonic acid, the heat produced by absorption exceeds even the heat which would be disengaged by the solidification of the gas. The heat produced by the absorption of these gases cannot, therefore, be explained by assuming that the gas is liquefied, or even solidified in the pores of the charcoal. It is probable that it is due to that produced by the liquefaction of the gas, and to the heat due to the imbibition of the liquid so produced in the charcoal.

The heat produced by the changes of condition has been already treated of in the articles *Solidification* and *Liquefaction*; the heat produced by electrical action will be discussed under the head of *Electricity*.

#### CHEMICAL SOURCES.

469. **Chemical combinations. Combustion.**—*Chemical combinations* are usually accompanied by a certain elevation of temperature. When these combinations take place slowly, as when iron oxidises in the air, the heat produced is imperceptible; but if they take place rapidly, the disengagement of heat is very intense. The same quantity of heat is produced in both cases, but when evolved slowly it is dissipated as fast as formed.

*Combustion* is chemical combination attended with the evolution of light and heat. In ordinary combustion in lamps, fires, candles, the carbon and hydrogen of the coal, or of the oil, etc., combine with the oxygen of the air. But combustion does not necessarily involve the presence of oxygen. If either powdered antimony or a fragment of phosphorus be placed in a vessel of chlorine, it unites with chlorine, producing thereby heat and flame.

Many combustibles burn with flame. A *flame* is a gas or vapour raised to a high temperature by combustion. Its illuminating power varies with the nature of the product formed. The presence of a solid body in the flame increases the illuminating power. The flames of hydrogen, carbonic oxide, and alcohol are pale, because they only contain gaseous products of combustion. But the flames of candles, lamps, coal gas, have a high illuminating power. They owe this to the fact that the high temperature produced decomposes certain of the gases with the production of carbon, which, not being perfectly burnt, becomes incandescent in the flame. Coal gas, when burnt in an arrangement by which it obtains an adequate supply of air, such as

a Bunsen's burner, is almost entirely devoid of luminosity. A non-luminous flame may be made luminous by placing in it platinum wire or asbestos. The temperature of a flame does not depend on its illuminating power. A hydrogen flame, which is the palest of all flames, gives the greatest heat.

Chemical decomposition in which the attraction of heterogeneous molecules for each other is overcome, and they are moved further apart, is an operation requiring an expenditure of work or an equivalent consumption of heat; and conversely, in chemical combination, motion is transformed into heat. When bodies attract each other chemically their molecules move towards each other with gradually increasing velocity, and when impact has taken place the progressive motion of the molecules ceases, and is converted into a rotating, vibrating, or progressive motion of the molecules of the new body.

The heat produced by chemical combination of two elements may be compared to that due to the impact of bodies against each other. Thus the action of the atoms of oxygen, which, in virtue of their progressive motion, and of chemical attraction, rush against ignited carbon, has been likened by Tyndall to the action of meteorites which fall into the sun.

**470. Heat disengaged during combustion.**—Many physicists, more especially Lavoisier, Rumford, Dulong, Despretz, Hess, Favre and Silberman, and Andrews, have investigated the quantity of heat disengaged by various bodies in chemical combinations.

In these experiments Lavoisier used the ice calorimeter already described. Rumford used a calorimeter known by his name, which consists of a rectangular copper canister filled with water. In this canister there is a worm which passes through the bottom of the box, and terminates below in an inverted funnel. Under this funnel is burnt the substance experimented upon. The products of combustion, in passing through the worm, heat the water of the canister, and from the increase of its temperature the quantity of heat evolved is calculated. Despretz and Dulong have successively modified Rumford's calorimeter by allowing the combustion to take place, not outside the canister, but in a chamber placed in the liquid itself; the oxygen necessary for the combustion entered by a tube in the lower part of the chamber, and the products of combustion escaped by another tube placed at the upper part and twisted in a serpentine form in the mass of the liquid to be heated. Favre and Silberman have improved this calorimeter very greatly (450), not only by avoiding or taking account of all possible sources of error, but by arranging it for the determination of the heat evolved in other chemical actions than those of ordinary combustion.

The experiments of MM. Favre and Silberman are the most trustworthy, as having been executed with the greatest care. They agree very closely with those of Dulong. Taking as thermal unit the heat necessary to raise the temperature of a pound of water through *one* degree Centigrade, the following table gives the thermal units in round numbers disengaged by a pound of each of the substances in burning in oxygen :—

Hydrogen . . . . .	34462	Oil of turpentine . . . . .	10852
Marsh gas . . . . .	13063	Olive oil . . . . .	9860
Olefiant gas . . . . .	11858	Ether . . . . .	9030

Anthracite . . . . .	8460	Phosphorus . . . . .	5750
Charcoal . . . . .	8080	Wood, dry . . . . .	4025
Coal . . . . .	8000	Bisulphide of carbon . . . . .	3401
Tallow . . . . .	8000	Wood, moist . . . . .	3100
Diamond . . . . .	7770	Carbonic oxide . . . . .	2400
Absolute alcohol . . . . .	7180	Sulphur . . . . .	2220
Coke . . . . .	7000	Iron . . . . .	1576

Bunsen's calorimeter has been used for studying the heat produced in chemical reactions for cases in which only very small quantities are available.

The experiments of Dulong, of Despretz, and of Hess prove that a body in burning always produces the same quantity of heat in reaching the same degree of oxidation, whether it attains this at once or only reaches it after passing through intermediate stages. Thus a given weight of carbon gives out the same amount of heat in burning directly to carbonic acid as if it were first changed into carbonic oxide, and then this were burnt into carbonic acid.

471. **Animal heat.**—In all the organs of the human body, as well as those of all animals, processes of oxidation are continually going on. Oxygen passes through the lungs into the blood, and so into all parts of the body. In like manner the oxidisable bodies, which are principally hydrocarbons, pass by the process of digestion into the blood, and likewise into all parts of the body, while the products of oxidation, carbonic acid and water, are eliminated, by the skin, the lungs, etc. Oxidation in the muscle produces motions of the molecules, which are changed into contraction of the muscular fibres; all other oxidations produce heat directly. When the body is at rest, all its functions, even involuntary motions, are transformed into heat. When the body is at work, the more vigorous oxidations of the working parts are transferred to the others. Moreover, a great part of the muscular work is changed into heat, by friction of the muscle and of the sinews in their sheaths, and of the bones in their sockets. Hence the heat produced by the body when at work is greater than when at rest. The blood distributes heat uniformly through the body, which in a normal condition has a temperature of 37.5. The blood of mammalia has the same temperature, that of birds is somewhat higher. In fever the temperature rises to 42°–44°, and in cholera, or when near death, sinks to 35°.

The function of producing work in the animal organism was formerly considered as separate from that of the production of heat. The latter was held to be due to the oxidation of the hydrocarbons of the fat, while the work was ascribed to the chemical activity of the nitrogenous matter. This view has now been generally abandoned; for it has been found that during work there is no increase in the secretion of urea, which is the result of the oxidation of nitrogenous matter; moreover, the organism while at rest produces less carbonic acid, and requires less oxygen than when it is at work; and the muscle itself, both in the living organism and also when removed from it and artificially stimulated, requires more oxygen in a state of activity than when at rest. For these reasons the production of work is also ascribed to the oxidation of organic matter.

The process of vegetation in the living plant is not in general connected

with any oxidation. . On the contrary, under the influence of the sun's rays, the green parts of plants decompose the carbonic acid of the atmosphere into free oxygen gas and into carbon, which, uniting with the elements of water, form cellulose, starch, sugar, and so forth. In order to effect this an expenditure of heat is required which is stored up in the plant and reappears during the combustion of wood or of the coal arising from its decomposition.

At the time of blossoming a process of oxidation goes on, which, as in the case of the blossoming of the *Victoria regia*, is attended with an appreciable increase of temperature.

#### HEATING.

472. **Different kinds of heating.**—*Heating* is the art of utilising for domestic and industrial purposes the sources of heat which nature offers to us.

Our principal source of artificial heat is the combustion of coal, coke, turf, wood, and charcoal.

We may distinguish five kinds of heating, according to the apparatus used : 1st, heating with an open fire ; 2nd, heating with an enclosed fire, as with a stove ; 3rd, heating by hot air ; 4th, heating by steam ; 5th, heating by the circulation of hot water.

473. **Fire-places.**—Fire-places are open hearths built against a wall under a chimney, through which the products of combustion escape.

However much they may be improved, fire-places will always remain the most imperfect and costly mode of heating, for they only render available 13 per cent. of the total heat yielded by coal or coke, and 6 per cent. of that by wood. This enormous loss of temperature arises from the fact that the current of air necessary for combustion always carries with it a large quantity of the heat produced, which is lost in the atmosphere. Hence

it was that Franklin said ' fire-places should be adopted in cases where the smallest quantity of heat was to be obtained from a given quantity of fuel.' Notwithstanding their want of economy, however, they will always be preferred as the healthiest and pleasantest mode of heating, on account of the cheerful light which they emit, and the ventilation which they ensure.

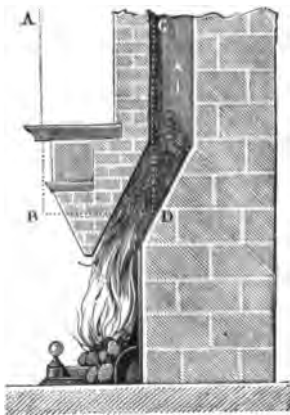

Fig. 361.

474. **Draught of fire-places.**—The *draught* of a fire is the upward current in the chimney caused by the ascent of the products of combustion ; when the current is rapid and continuous, the chimney is said to *draw well*.

The draught is caused by the difference between the temperature of the inside and that on the outside of the chimney ; for, in consequence of this difference, the gaseous substances which fill the chimney are lighter than the air of the room, and consequently equilibrium is impos-

sible. The weight of the column of gas CD, fig. 361, in the chimney being less than that of the external column of air AB of the same height, there is a pressure from the outside to the inside which causes the products of combustion to ascend the more rapidly in proportion as the difference in weight of the two gaseous masses is greater.

The velocity of the draught of a chimney may be determined theoretically by the formula

$$v = \sqrt{2ga(\ell - t)h},$$

in which  $g$  is the acceleration of gravity,  $a$  the coefficient of the expansion of air,  $h$  the height of the chimney,  $\ell$  the mean temperature of the air inside the chimney, and  $t$  the temperature of the surrounding air.

The currents caused by the difference in temperature of two communicating gaseous masses may be demonstrated by placing a candle near the top and near the bottom of the partially-opened door of a warm room. At the top, the flame will be turned from the room towards the outside, while the contrary effect will be produced when the candle is placed on the ground. The two effects are caused by the current of heated air which issues by the top of the door, while the cold air which replaces it enters at the bottom.

In order to have a good draught, a chimney ought to satisfy the following conditions :

i. The section of the chimney ought not to be larger than is necessary to allow an exit for the products of combustion ; otherwise ascending and descending currents are produced in the chimney, which cause it to smoke. It is advantageous to place on the top of the chimney a conical pot narrower than the chimney, so that the smoke may escape with sufficient velocity to resist the action of the wind.

ii. The chimney ought to be sufficiently high, for, as the draught is caused by the excess of the external over the internal pressure, this excess is greater in proportion as the column of heated air is longer.

iii. The external air ought to pass into the chamber with sufficient rapidity to supply the wants of the fire. In an hermetically-closed room the combustibles would not burn, or descending currents would be formed which would drive the smoke into the room. Usually air enters in sufficient quantity by the crevices of the doors and windows.

iv. Two chimneys should not communicate, for if one draws better than the other, a descending current of air is produced in the latter, which carries smoke with it.

For the strong fires required by steam boilers and the like, very high chimneys are needed ; of course the increase in height would lose its effect if the hot column above became cooled down. Hence chimneys are often made with hollow walls, that is of separate concentric layers of masonry, the space between them containing air.

475. **Stoves.**—*Stoves* are apparatus for heating with a detached fire, placed in the room to be heated, so that the heat radiates in all directions round the stove. At the lower part is the draught hole by which the air necessary for combustion enters. The products of combustion escape by means of iron chimney pipes. This mode of heating is one of the most

economical, but it is by no means so healthy as that by open fire-places, for the ventilation is very bad, more especially where, as in Sweden and in Germany, the stoves are fed from the outside of the room. These stoves also emit a bad smell, probably arising from the decomposition of organic substances in the air by their contact with the heated sides of the chimney pipes; or possibly, as Deville and Troost's researches seem to show, from the diffusion of gases through the heated sides of the stove.

The heating is very rapid with blackened metal stoves, but they also cool very rapidly. Stoves constructed of polished earthenware, which are common on the Continent, heat more slowly, but more pleasantly, and they retain the heat longer.

476. **Heating by steam.**—Steam, in condensing, gives up its latent heat of vaporisation, and this property has been used in heating baths, workshops, public buildings, hothouses, etc. For this purpose steam is generated in boilers similar to those used for steam-engines, and is then made to circulate in pipes placed in the room to be heated. The vapour condenses, and in doing so imparts to the pipes the latent heat, which becomes free, and thus heats the surrounding air.

477. **Heating by hot air.**—Heating by hot air consists in heating the air in the lower part of a building, from whence it rises to the higher parts

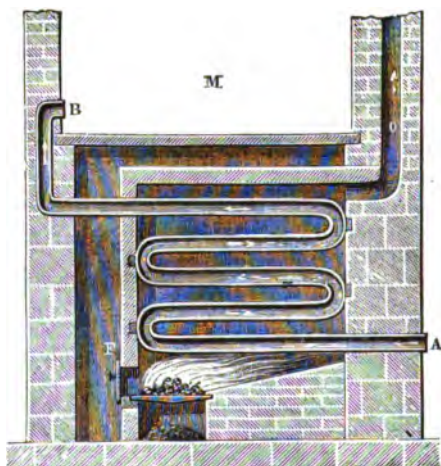

Fig. 362.

in virtue of its lessened density. The apparatus is arranged as represented in figure 362.

A series of bent tubes, AB, only one of which is shown in the figure, is placed in a furnace, F, in the cellar. The air passes into the tubes through the lower end A, where it becomes heated, and, rising in the direction of the arrows, reaches the room M by a higher aperture B. The various rooms to be heated are provided with one or more of these apertures, which are placed as low in the room as possible. The conduit O is an ordinary chim-

ney. These apparatus are more economical than open fire-places, but they are less healthy, when no special provision is made for ventilation.

478. **Heating by hot water.**—This consists of a continuous circulation of water, which having been heated in a boiler rises through a series of tubes, and then, after becoming cool, passes into the boiler again by a similar series.

Figure 363 represents an apparatus for heating a building of several stories. The heating apparatus, which is in the cellar, consists of a bell-

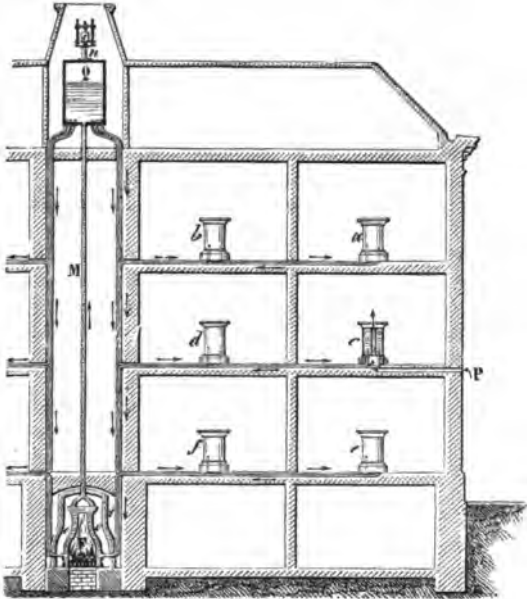

Fig. 363.

shaped boiler, *oo*, with an internal flue, *F*. A long pipe, *M*, fits in the upper part of the boiler, and also in the reservoir *Q*, placed in the upper part of the building to be heated. At the top of this reservoir there is a safety valve, *s*, by which the pressure of the vapour in the interior can be regulated.

The boiler, the pipe *M*, and a portion of the reservoir, *Q*, being filled with water, as it becomes heated in the boiler, an ascending current of hot water rises to the reservoir *Q*, while at the same time descending currents of colder and denser water pass from the lower part of the reservoir *Q* into receivers *b*, *d*, *f*, filled with water. The water from these passes again through pipes into other receivers, *a*, *c*, *e*, and ultimately reaches the lower part of the boiler.

During this circulation the hot water heats the pipes and the receivers, which thus become true water stoves. The number and the dimensions of these parts are determined from the fact that a cubic foot of water in falling through a temperature of one degree can theoretically communicate the



same increase of temperature to 3,200 cubic feet of air. In the interior of the receivers *a, b, c, d, e, f*, there are cast-iron tubes which communicate with the outside by pipes, *P*, placed underneath the flooring. The air becomes heated in these tubes, and emerges at the upper part of the receivers.

The principal advantage of this mode of heating is that of giving a temperature which is constant for a long time; for the mass of water only cools slowly. It is much used in hothouses, baths, artificial incubation, drying rooms, and generally wherever a uniform temperature is desired.

#### SOURCES OF COLD.

479. **Various sources of cold.**—Besides the cold caused by the passage of a body from a solid to the liquid state, of which we have already spoken, cold is produced by the expansion of gases, by radiation in general, and more especially by nocturnal radiation.

480. **Cold produced by the expansion of gases. Ice machines.**—We have seen that when a gas is compressed, the temperature rises. The reverse of this is also the case: when a gas is rarefied a reduction of temperature ensues, because a quantity of sensible heat disappears when the gas becomes increased to a larger volume. This may be shown by placing a delicate Breguet's thermometer under the receiver of an air-pump, and exhausting; at each stroke of the piston the needle moves in the direction of zero, and regains its original temperature when air is admitted.

The production of cold when a gas is expanded has been extensively applied in machines for artificial refrigeration on a large scale. By Windhausen's ice machine, by means of a steam-engine of from 6 to 20 horse-power, from 15,000 to 150,000 feet of air can be cooled through 40 to 100 degrees in temperature. The essential parts of this machine are represented in fig. 364.

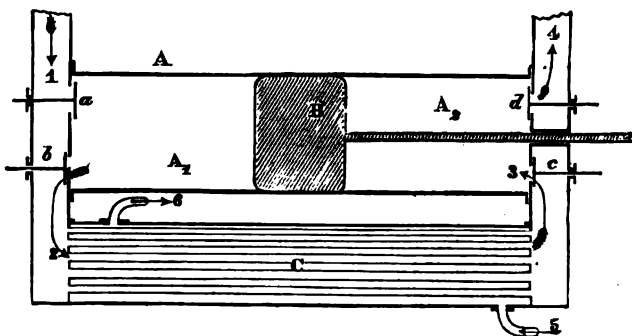

Fig. 364.

The piston *B* in the cylinder *A* is worked to the right by a steam-engine and to the left by a steam-engine and by the compressed air. As it moves towards the right the valve *a* opens, and air under the ordinary atmospheric pressure enters the space *A*<sub>1</sub>. When this is full the piston moves towards

the left, the air in  $A_1$  is compressed to about 2 atmospheres, the valve  $a$  is closed, the valve  $b$  opens, and air passes in the direction of the arrows into the cooler, C. By its compression it has become strongly heated, and the necessary cooling is effected by means of pipes through which cold water circulates, entering at 5 and emerging at 6. The air thus compressed and cooled passes out through the valve  $c$ , which is automatically worked by the machine, into the space  $A_2$ , where, in conjunction with the steam-engine, it moves the piston to the left, and compresses the air in  $A_1$ ; for at a certain position of the piston the valve  $c$  is closed, the compressed air in the cylinder  $A_2$  expands, and thereby is cooled far below the freezing point. As the piston moves again to the right, the valve  $d$  is opened by the working of the machine, and the cooled air emerges through the tube 4 to its destination. If it passes into an ordinary room it fills it with snowflakes. Machines of this kind are extensively employed in the arts, in breweries, oil refineries, in the artificial production of ice, etc.

481. **Cold produced by nocturnal radiation.**—During the day, the ground receives from the sun more heat than radiates into space, and the temperature rises. The reverse is the case during night. The heat which the earth loses by radiation is no longer compensated for, and consequently a fall of temperature takes place, which is greater according as the sky is clearer, for clouds send towards the earth rays of greater intensity than those which come from the celestial spaces. In some winters it has been found that rivers have not frozen, the sky having been cloudy, although the thermometer has been for several days below  $-4^\circ$ ; while in other less severe winters the rivers freeze when the sky is clear. The emissive power exercises a great influence on the cold produced by radiation; the greater it is the greater is the cold.

In Bengal, the nocturnal cooling is used in manufacturing ice. Large flat vessels containing water are placed on non-conducting substances, such as straw or dry leaves. In consequence of the radiation the water freezes, even when the temperature of the air is  $10^\circ$  C. The same method can be applied in all cases with a clear sky.

It is said that the Peruvians, in order to preserve the shoots of young plants from freezing, light great fires in their neighbourhood, the smoke of which, producing an artificial cloud, hinders the cooling produced by radiation.

482. **Absolute zero of temperature.**—As a gas is increased  $\frac{1}{273}$  of its volume for each degree Centigrade, it follows that at a temperature of  $273^\circ$  C. the volume of any gas measured at zero is doubled. In like manner, if the temperature of a given volume at zero were lowered through  $-273^\circ$ , the contraction would be equal to the volume; that is, the volume would not exist. At this temperature the motion of the molecules of the gas would completely cease, and the pressure thereby occasioned. In all probability, before reaching this temperature, gases would undergo some change.

This point on the Centigrade scale is called the *absolute zero of temperature*; the temperatures reckoned from this point are called *absolute temperatures*. They are clearly obtained by adding 273 to the temperature on the Centigrade scale. Thus  $-35^\circ$  C. is  $238^\circ$  on the absolute scale of temperature, and  $+15^\circ$  C. is  $288^\circ$ .

## CHAPTER XII.

## MECHANICAL EQUIVALENT OF HEAT.

483. **Mechanical equivalent of heat.**—If the various instances of the production of heat by motion be examined, it will be found that in all cases mechanical force is consumed. Thus, in rubbing two bodies against each other, motion is apparently destroyed by friction; it is not, however, lost, but appears in the form of a motion of the particles of the body; the motion of the mass is transformed into a motion of the molecules.

Again, if a body be allowed to fall from a height, it strikes against the ground with a certain velocity. According to older views, its motion is destroyed, *vis viva* is lost. This, however, is not the case; the *vis viva* of the body appears as *vis viva* of its molecules.

In the case, too, of chemical action, the most productive artificial source of heat, it is not difficult to conceive that there is in the act of combining an impact of the dissimilar molecules against each other, an effect analogous to the production of heat by the impact of masses of matter against each other (469).

In like manner, heat may be made to produce motion, as in the case of the steam-engine, and the propulsion of shot from a gun.

Traces of a view that there is a connection between heat and motion are to be met with in the older writers, Bacon for example; and Locke says, 'Heat is a very brisk agitation of the insensible parts of the object, which produces in us that sensation from whence we denominate the object hot; so that what in our sensation is heat, in the object is nothing but motion.' Rumford, in explaining his great experiment of the production of heat by friction, was unable to assign any other cause for the heat produced than motion; and Davy, in the explanation of his experiment of melting ice by friction *in vacuo*, expressed similar views. Carnot, in a work on the steam-engine, published in 1824, also indicated a connection between heat and work.

The views, however, which had been stated by isolated writers had little or no influence on the progress of scientific investigation, and it is in the year 1842 that the modern theories may be said to have had their origin. In that year Dr. Mayer, a physician in Heilbronn, formally stated that there exists a connection between heat and work; and he it was who first introduced into science the expression '*mechanical equivalent of heat.*' Mayer also gave a method by which this equivalent could be calculated; the particular results, however, are of no value, as the method, though correct in principle, is founded on incorrect data.

In the same year, too, Colding of Copenhagen published experiments on the production of heat by friction, from which he concluded that the evolution of heat was proportional to the mechanical energy expended.

About the same time as Mayer, but quite independently of him, Joule commenced a series of experimental investigations on the relation between heat and work. These first drew the attention of scientific men to the subject, and were admitted as a proof that the transformation of heat into me-

chanical energy, or of mechanical energy into heat, always takes place in a definite numerical ratio.

Subsequently to Mayer and Joule, several physicists by their theoretical and experimental investigations, have contributed to establish the mechanical theory of heat, namely, in this country, Sir W. Thomson and Rankine; in Germany, Helmholtz, Clausius, and Holtzmann; and in France, Clapeyron and Regnault.

The following are some of the most important and satisfactory of Joule's experiments.

A copper vessel, B (fig. 365), was provided with a brass paddle-wheel (indicated by the dotted lines), which could be made to rotate about a vertical axis. Two weights, E and F, were attached to cords which passed over the pulleys C and D, and were connected with the axis A. These weights in falling cause the wheel to rotate. The height of the fall, which in Joule's experiments was about 63 feet, was indicated on the scales

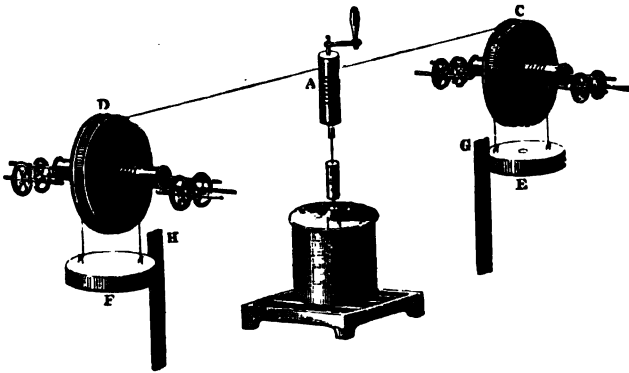

Fig. 365.

G and H. The roller A was so constructed that by detaching a pin the weights could be raised without moving the wheel. The vessel B was filled with water and placed on a stand, and the weights allowed to sink. When they had reached the ground, the roller was detached from the axis, and the weights again raised, the same operations being repeated 20 times. The heat produced was measured by ordinary calorimetric methods (434).

The work expended is measured by the product of the weight into the height through which it falls, or  $ph$ , less the work lost by the friction of the various parts of the apparatus. This is diminished as far as possible by the use of friction wheels (78), and its amount is determined by connecting C and D without causing them to pass over A, and then determining the weight necessary to communicate to them a uniform motion.

In this way it has been found that a thermal unit—that is, the quantity of heat by which a pound of water is raised through  $1^{\circ}$  C.—is generated by the expenditure of the same amount of work as would be required to raise 1,392 pounds through 1 foot, or 1 pound through 1,392 feet. This is expressed by

saying that the mechanical equivalent of the thermal unit is 1,392 foot-pounds.

The friction of an iron paddle-wheel in mercury gave 1,397 foot-pounds, and that of the friction of two iron plates gave 1,395 foot-pounds, as the mechanical equivalent of one thermal unit.

In another series of experiments, the air in a receiver was compressed by means of a force pump, both being immersed in a known weight of water at a known temperature. After 300 strokes of the piston, the heat,  $C$ , was measured which the water had gained. This heat was due to the compression of the air and to the friction of the piston. To eliminate the latter influence, the experiment was made under the same conditions, but leaving the receiver open. The air was not compressed, and 300 strokes of the piston developed  $C'$  thermal units. Hence  $C - C'$  is the heat produced by the compression of the gas. Representing the foot-pounds expended in producing this heat by  $W$ , we have  $\frac{W}{C - C'}$  for the value of the mechanical equivalent.

By this method Joule obtained the number 1,442.

The mean number which Joule adopted for the mechanical equivalent of one thermal unit on the Centigrade scale is 1,390 foot-pounds; on the Fahrenheit scale it is 772 foot-pounds. The number is called *Joule's equivalent*.

On the metrical system 424 metres is taken as the height through which a kilogramme of water must fall to raise its temperature 1 degree Centigrade.

Hirn has made the following determination of the mechanical equivalent by means of the heat produced by the compression of lead. A large block of sandstone, CD (fig. 366), is suspended vertically by cords; its weight

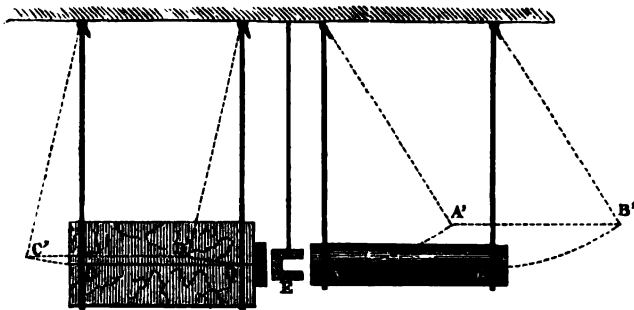

Fig. 366.

is  $P$ .  $E$  is a piece of lead, fashioned so that its temperature may be determined by the introduction of a thermometer. The weight of this is  $\Pi$ , and its specific heat  $c$ .  $AB$  is a cylinder of cast iron, whose weight is  $\rho$ . If this be raised to  $A'B'$ , a height of  $h$ , and allowed to fall again, it compresses the lead,  $E$ , against the anvil,  $CD$ . It remains to measure on the one hand the work lost, and on the other the heat gained.

The hammer  $AB$  being raised to a height  $h$ , the work of its fall is  $\rho h$ ,

but as, by its elasticity, it rises again to a height  $h_1$ , the work is  $p(h-h_1)$ . The anvil, CD, on the other hand, has been raised through a height H to C' D', and has absorbed in so doing PH units of work. The work, W, definitely absorbed by the lead is  $p(h-h_1) - PH$ . On the other hand, the lead has been heated by  $\theta$ , it has gained  $\Pi c\theta$  thermal units,  $c$  being the specific heat of lead, and the mechanical equivalent J is equal to the quotient  $\frac{W}{\Pi c\theta}$ . A series of six

experiments gave 1,394 for the mechanical equivalent as thus obtained.

The following is the method which Mayer employed in calculating the mechanical equivalent of heat. It is taken, with slight modifications, from Prof. Tyndall's work on 'Heat,' who, while strictly following Mayer's reasoning, has corrected his data.

Let us suppose that a rectangular vessel with a section of a square foot contains at  $0^\circ$  a cubic foot of air under the ordinary atmospheric pressure; and let us suppose that it is enclosed by a piston without weight.

Suppose now that the cubic foot of air is heated until its volume is doubled; from the coefficient of expansion of air we know that this is the case at  $273^\circ$  C. The gas in doubling its volume will have raised the piston through a foot in height; it will have lifted the atmospheric pressure through this distance. But the atmospheric pressure on a square foot is in round numbers  $15 \times 144 = 2,160$  pounds. Hence a cubic foot of air in doubling its volume has lifted a weight of 2,160 pounds through a height of a foot.

Now a cubic foot of air at zero weighs 1.29 ounce, and the specific heat of air under constant pressure, that is, when it can expand freely, as compared with that of an equal weight of water, is 0.24; so that the quantity of heat which will raise 1.29 ounce of air through  $273^\circ$  will only raise  $0.24 \times 1.29 = 0.31$  oz. of water through the same temperature; but 0.31 oz. of water raised through  $273^\circ$  is equal to 5.29 pounds of water raised through  $1^\circ$  C.

That is, the quantity of heat which will double the volume of a cubic foot of air, and in so doing will lift 2,160 pounds through a height of a foot, is 5.29 thermal units.

Now in the above case the gas has been heated under constant pressure, that is, when it could expand freely. If, however, it had been heated under constant volume, its specific heat would have been less in the ratio 1 : 1.414 (447), so that the quantity of heat required under these circumstances to raise the temperature of a cubic foot of air would be  $5.29 \times \frac{1}{1.41} = 3.74$ . De-

ducting this from 5.29, the difference 1.55 represents the weight of water which would have been raised  $1^\circ$  C. by the excess of heat imparted to the air when it could expand freely. But this excess has been consumed in the work of raising 2,160 pounds through a foot. Dividing this by 1.55 we have 1,393. Hence the heat which will raise a pound of water through  $1^\circ$  C. will raise a weight of 1,393 pounds through a height of a foot; a numerical value of the mechanical equivalent of heat agreeing as closely as can be expected with that which Joule adopted as the most certain of his experimental results.

The law of the relation of heat to mechanical energy may be thus stated: *Heat and mechanical energy are mutually convertible; and heat requires for*

*its production, and produces by its disappearance, mechanical energy in the ratio of 1,390 foot-pounds for every thermal unit.*

A variety of experiments may in like manner be adduced to show that whenever heat disappears work is produced. For example, if in a reservoir immersed in water the air be compressed to the extent of 10 atmospheres : supposing that now, when the compressed air has acquired the temperature of the water, it be allowed to act upon a piston loaded by a weight, the weight is raised. At the same time the water becomes cooler, showing that a certain quantity of heat had disappeared in producing the mechanical effort of raising the weight. This may also be illustrated by the following experiment, due to Prof. Tyndall.

A strong metal box is taken, provided with a stopcock, on which can be screwed a small condensing pump. Having compressed the air by its means, as it becomes heated by this process, the box is allowed to stand for some time, until it has acquired the temperature of the surrounding medium. On

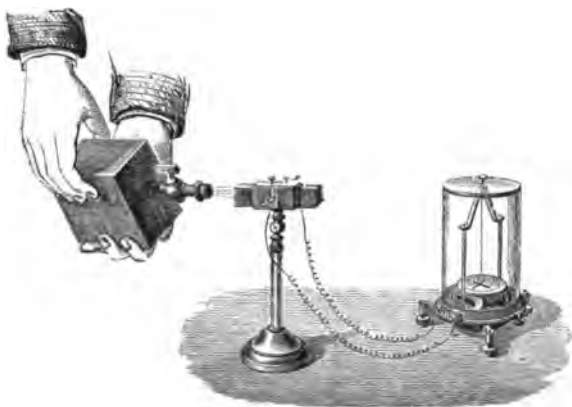

Fig. 367.

opening the stopcock, the air rushes out ; it is expelled by the expansive force of the internal air ; in short, the air drives itself out. Work is therefore performed by the air, and there should be a disappearance of heat ; and if the jet of air be allowed to strike against the thermo-pile, the galvanometer is deflected, and the direction of its deflection indicates a cooling (fig. 367). The same effect is observed when, on opening a bottle of soda water, the carbonic gas which escapes is allowed to impinge against the thermo-pile.

If, on the contrary, the experiment is made with an ordinary pair of bellows, and the current of air is allowed to strike against the battery, the deflection of the galvanometer is in the opposite direction, indicating an increase of temperature (fig. 368). In this case the hand of the experimenter performs the work, which is converted into heat.

**Joule** placed in a calorimeter two equal copper reservoirs, which could

be connected by a tube. One of these contained air at 22 atmospheres, the other was exhausted. When they were connected, they came into equilibrium under a pressure of 11 atmospheres; but as the gas in expanding had done no work, there was no alteration in temperature. When, however, the

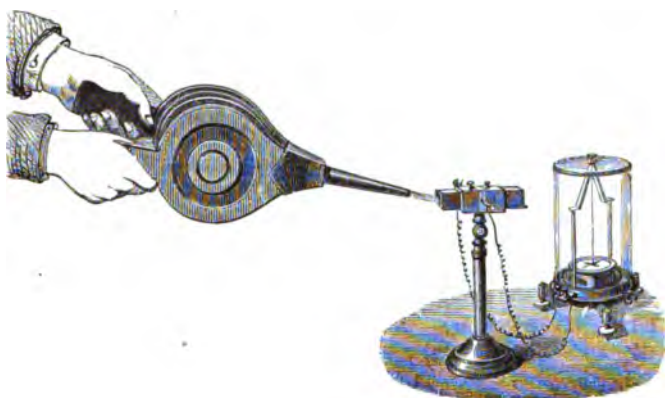

Fig. 368.

second reservoir was full of water, the air in entering was obliged to expel it and thus perform work, and the temperature sank, owing to an absorption of heat.

For further information the student of this subject is referred to the following works: Tyndall on *Heat as a Mode of Motion*, Maxwell on *Heat* (Longmans), Balfour Stewart on *Heat* (Macmillan), and Tait on *Thermodynamics* (Edmonston and Douglas). A condensed, though complete and systematic account of the dynamical theory of heat is met with in Professor Foster's articles on 'Heat,' in Watts's *Dictionary of Chemistry*.

**484. Dissipation of energy.**—Rankine has the following interesting observations on a remarkable consequence of the mutual convertibility which has been shown to exist between heat and other forms of energy. Sir W. Thomson has pointed out the fact, that there exists, at least in the present state of the known world, a predominating tendency to the conversion of all the other forms of physical energy into heat, and to the uniform diffusion of all heat throughout all matter. The form in which we generally find energy originally collected is that of a store of chemical power consisting of uncombined elements. The combination of these elements produces energy in the form known by the name of electrical currents, part only of which can be employed in analysing chemical compounds, and thus reconverted into a store of chemical power; the remainder is necessarily converted into heat; a part only of this heat can be employed in analysing compounds or in reproducing electric currents. If the remainder of the heat be employed in expanding an elastic substance, it may be converted entirely into visible motion, or into a store of visible mechanical power (by raising weights, for example), provided the elastic substance is enabled to expand until its temperature falls to the point which corresponds to the absolute privation



of heat ; but unless this condition is fulfilled, a certain proportion only of the heat, depending on the range of temperature through which the elastic body works, can be converted, the rest remaining in the state of heat. On the other hand, all visible motion is of necessity ultimately converted into heat by the agency of friction. There is, then, in the present state of the known world, a tendency towards the conversion of all physical energy into the sole form of heat.

Heat, moreover, tends to diffuse itself uniformly by conduction and radiation, until all matter shall have acquired the same temperature. There is, consequently, so far as we understand the present condition of the universe, a tendency towards a state in which all physical energy will be in the state of heat, and that heat so diffused, that all matter will be at the same temperature ; so that there will be an end of all physical phenomena.

Vast as this speculation may seem, it appears to be soundly based on experimental data, and to truly represent the present condition of the universe as far as we know it.

## BOOK VII.

## ON LIGHT.

## CHAPTER I.

## TRANSMISSION, VELOCITY, AND INTENSITY OF LIGHT.

485. **Theories of light.**—*Light* is the agent which, by its action on the retina, excites in us the sensation of vision. That part of physics which deals with the properties of light is known as *optics*.

In order to explain the origin of light, various hypotheses have been made, the most important of which are the *emission* or *corpuscular* theory, and the *undulatory* theory.

On the *emission* theory it is assumed that luminous bodies emit, in all directions, an imponderable substance, which consists of molecules of an extreme degree of tenuity; these are propagated in right lines with an almost infinite velocity. Penetrating into the eye they act on the retina, and determine the sensation which constitutes vision.

On the undulatory theory, all bodies, as well as the celestial spaces, are filled by an extremely subtle elastic medium, which is called the *luminiferous ether*. The luminosity of a body is due to an infinitely rapid vibratory motion of its molecules, which, when communicated to the ether is propagated in all directions in the form of spherical waves, and this vibratory motion, being thus transmitted to the retina, calls forth the sensation of vision. The vibrations of the ether take place not in the direction of the wave, but in a plane at right angles to it. The latter are called the *transversal* vibrations. An idea of these may be formed by shaking a rope at one end. The vibrations, or to and fro movements, of the particles of the rope, are at right angles to the length of the rope, but the onward motion of the wave's form is in the direction of the length.

On the emission theory the propagation of light is effected by a motion of *translation* of particles of light thrown out from the luminous body, as a bullet is discharged from a gun; on the undulatory theory there is no progressive motion of the particles themselves, but only of the state of disturbance which was communicated by the luminous body; it is a motion of *oscillation*, and, like the propagation of waves in water, takes place by series of vibrations.

The luminiferous ether penetrates all bodies, but on account of its extreme tenuity it is uninfluenced by gravitation; it occupies space, and

although it presents no appreciable resistance to the motion of the denser bodies, it is possible that it hinders the motion of the smaller comets. It has been found, for example, that Encke's comet, whose period of revolution is about  $3\frac{1}{2}$  years, has its period diminished by about 0.11 of a day at each successive rotation, and this diminution is ascribed by some to the resistance of the ether.

The fundamental principles of the undulatory theory were enunciated by Huyghens, and subsequently by Euler. The emission theory, principally owing to Newton's powerful support, was for long the prevalent scientific creed. The undulatory theory was adopted and advocated by Young, who showed how a large number of optical phenomena, particularly those of diffraction, were to be explained by that theory. Subsequently to, though independently of, Young, Fresnel showed that the phenomena of diffraction, and also that of polarisation, are explicable on the same theory, which, since his time, has been generally accepted.

The undulatory theory not only explains the phenomena of light, but it reveals an intimate connection between these phenomena and those of heat (417); it shows also how completely analogous the phenomena of light are to those of sound, regard being had to the differences of the media in which these two classes of phenomena take place.

**486. Luminous, transparent, translucent, and opaque bodies.**—*Luminous* bodies are those which emit light, such as the sun, and ignited bodies. *Transparent* or *diaphanous* bodies are those which readily transmit light, and through which objects can be distinguished; water, gases, polished glass, are of this kind. *Translucent* bodies transmit light, but objects cannot be distinguished through them: ground glass, oiled paper, etc., belong to this class. *Opaque* bodies do not transmit light; for example, wood, metals, etc. No bodies are quite opaque; they are all more or less translucent when cut in sufficiently thin leaves.

Foucault has shown that when the object glass of a telescope is thinly silvered, the layer is so transparent that the sun can be viewed through it without danger to the eyes, since the metallic surface reflects the greater part of the heat and light.

**487. Luminous ray and pencil.**—A *luminous ray* is the direction of the line in which light is propagated; a *luminous pencil* is a collection of rays from the same source; it is said to be *parallel* when it is composed of parallel rays, *divergent* when the rays separate from each other, and *convergent* when they tend towards the same point. Every luminous body emits divergent rectilinear rays from all its points, and in all directions.

**488. Propagation of light in a homogeneous medium.**—A *medium* is any space or substance which light can traverse, such as a vacuum, air, water, glass, etc. A medium is said to be *homogeneous* when its chemical composition and density are the same in all parts.

*In every homogeneous medium light is propagated in a right line.* For, if an opaque body is placed in the right line which joins the eye and the luminous body, the light is intercepted. The light which passes into a dark room by a small aperture leaves a luminous trace, which is visible from the light falling on the particles suspended in the atmosphere.

Light changes its direction on meeting an object which it cannot pene-

trate, or when it passes from one medium to another. These phenomena will be described under the heads *reflection* and *refraction*.

489. **Shadow, penumbra.**—When light falls upon an opaque body it cannot penetrate into the space immediately behind it, and this space is called the *shadow*.

In determining the extent and the shape of a shadow projected by a body, two cases are to be distinguished; that in which the source of light is a single point, and that in which it is a body of any given extent.

In the first case, let S (fig. 369) be the luminous point, and M a spherical body, which causes the shadow. If an infinitely long straight line, SG

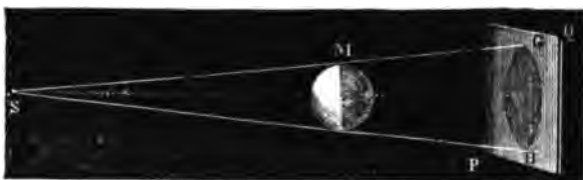

Fig. 369.

move round the sphere M tangentially, always passing through the point S, this line will produce a conical surface, which, beyond the sphere, separates that portion of space which is in shadow from that which is illuminated. In the present case, on placing behind the opaque body a screen, PQ, the limit of the shadow HG will be sharply defined. This is not, however, usually the case, for luminous bodies have always a certain magnitude, and are not merely luminous points.

Suppose that the luminous and illuminated bodies are two spheres, SL and MN (fig. 370). If an infinite straight line, AG, moves tangentially to

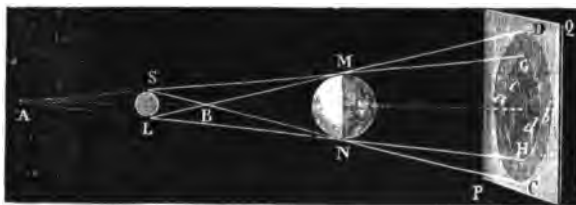

Fig. 370.

both spheres, always cutting the line of the centre in the point A it will produce a conical surface with this point for a summit, and which traces behind the sphere MN a perfectly dark space, MGHN. If a second right line, LD, which cuts the line of centre in B, moves tangentially to the two spheres, so as to produce a new conical surface, BDC, it will be seen that all the space outside this surface is illuminated, but that the part between the two conical surfaces is neither quite dark nor quite light. So that if a screen, PQ, is placed behind the opaque body, the portion cGdH of the screen is quite in the shadow, while the space ab receives light from certain

parts of the luminous body, and not from others. It is brighter than the true shadow, and not so bright as the rest of the screen, and it is accordingly called the *penumbra*.

Shadows such as these are *geometrical shadows*; *physical shadows*, or those which are really seen, are by no means so sharply defined. A certain quantity of light passes into the shadow, even when the source of light is a mere point, and conversely the shadow influences the illuminated part. This phenomenon, which will be afterwards described, is known by the name of *diffraction* (628).

**490. Images produced by small apertures.**—When luminous rays, which pass into a dark chamber *through a small aperture*, are received upon a screen, they form images of external objects. These images are inverted; their shape is always that of the external objects, and is independent of the shape of the aperture.

The inversion of the images arises from the fact that the luminous rays proceeding from external objects, and penetrating into the chamber, cross one another in passing the aperture, as shown in fig. 371. Continuing in

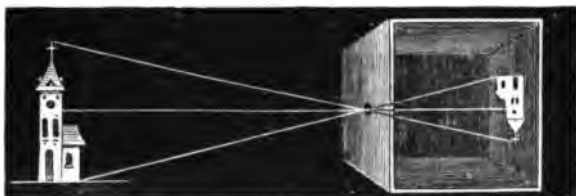

Fig. 371.

a straight line, the rays from the higher parts meet the screen at the lower parts, and conversely, those which come from the lower parts meet the higher parts of the screen. Hence the inversion of the image. In the article *Camera Obscura*, it will be seen how the brightness and precision of these images are increased by means of lenses.

In order to show that the shape of the image is independent of that of the aperture, when the latter is sufficiently small and the screen at an adequate distance, imagine a triangular aperture, O (fig. 372), made in the door

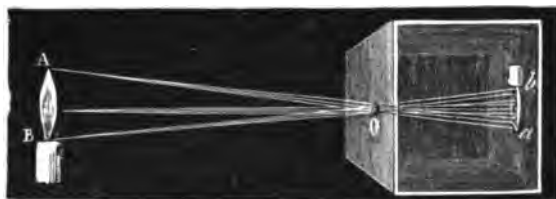

Fig. 372

of a dark chamber, and let *ab* be a screen on which is received the image of a flame, AB. A divergent pencil from each point of the flame penetrates

through the aperture, and forms on the screen a triangular image resembling the aperture. But the union of all these partial images produces a total image of the same form as the luminous object. For if we conceive that an infinite straight line moves round the aperture, with the condition that it is always tangential to the luminous object AB, and that the aperture is very small, the straight line describes two cones, the apex of which is the aperture, while one of the bases is the luminous object and the other the luminous object on the screen—that is, the image. Hence, if the screen is perpendicular to the right line joining the centre of the aperture and the centre of the luminous body, the image is similar to the body; but if the screen is oblique, the image is elongated in the direction of its obliquity. This is what is seen in the shadow produced by foliage; the luminous rays passing through the leaves produce images of the sun, which are either round or elliptical, according as the ground is perpendicular or oblique to the solar rays, and this is the case whatever be the shape of the aperture through which the light passes.

491. **Velocity of light.**—Light moves with such a velocity that at the surface of the earth there is, to ordinary observation, no appreciable interval between the occurrence of any luminous phenomenon and its perception by the eye. And accordingly, this velocity was first determined by means of astronomical observations. Romer, a Danish astronomer, in 1675, first deduced the velocity of light from an observation of the eclipses of Jupiter's first satellite.

Jupiter is a planet, round which four satellites revolve, as the moon does round the earth. This first satellite, E (fig. 373), suffers occultation—that



Fig. 373.

is, passes into Jupiter's shadow—at equal intervals of time, which are 42h. 28m. 36s. While the earth moves in that part of its orbit, *ab*, nearest Jupiter, its distance from that planet does not materially alter, and the intervals between two successive occultations of the satellite are approximately the same; but in proportion as the earth moves away in its revolution round the sun, S, the interval between two occultations increases, and when, at the end of six months, the earth has passed from the position T to the position T', a total retardation of 16m. 36s. is observed between the time at which the phenomenon is seen and that at which it is calculated to take place. But when the earth was in the position T, the sun's light reflected from the satellite E had to traverse the distance ET, while in the second position the light had to traverse the distance ET'. This distance exceeds the first by the quantity TT', for, from the great distance of the

satellite E, the rays ET and ET' may be considered parallel. Consequently, light requires 16m. 36s. to travel the diameter TT' of the terrestrial orbit, or twice the distance of the earth from the sun, which gives for its velocity 190,000 miles in a second.

The stars nearest the earth are separated from it by at least 206,265 times the distance of the sun. Consequently, the light which they send requires  $3\frac{1}{4}$  years to reach us. Those stars, which are only visible by means of the telescope, are possibly at such a distance that thousands of years would be required for their light to reach our planetary system. They might have been extinguished for years without our knowing it.

492. **Foucault's apparatus for determining the velocity of light.**— Notwithstanding the prodigious velocity of light, M. Foucault has succeeded in determining it experimentally by the aid of an ingenious apparatus, based on the use of the rotating mirror, which was adopted by Mr. Wheatstone in measuring the velocity of electricity.

In the description of this apparatus, a knowledge of the principal properties of mirrors and of lenses is presupposed. Fig. 374 represents the princi-

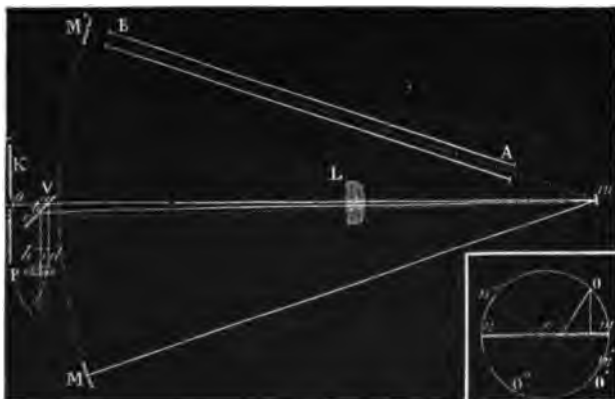

Fig. 374.

Fig. 375.

pal parts of M. Foucault's arrangement. The window shutter, K, of a dark chamber is perforated by a square aperture, behind which a platinum wire, *o*, is stretched vertically. A beam of solar light reflected from the outside upon a mirror enters the dark room by the square aperture, meets the platinum wire, and then traverses an achromatic lens, L, with a long focus, placed at a distance from the platinum wire less than double the principal focal distance. The image of the platinum wire, more or less magnified, would thus be formed on the axis of the lens; but the luminous pencil having traversed the lens, impinges on a plane mirror, *m*, rotating with great velocity; it is reflected from this, and forms in space an image of the platinum wire, which is displaced with an angular velocity double that of the mirror (506). This image is reflected by a concave mirror, M, whose centre of curvature coincides with the axis of rotation of the mirror *m*, and with its

centre of figure. The pencil reflected from the mirror *M* returns upon itself, is again reflected from the mirror *m*, traverses the lens a second time, and forms an image of the platinum wire, which appears on the wire itself so long as the mirror *m* turns slowly.

In order to see this image without hiding the pencil of light which enters by the aperture in *K*, a mirror of unsilvered glass, *V*, with parallel faces, is placed between the lens and the wire, and is inclined so that the reflected rays fall upon a powerful eyepiece, *P*.

The apparatus being arranged, if the mirror *m* is at rest, the ray after meeting *M* is reflected to *m*, and from thence returns along its former path, till it meets the glass plate *V* in *a*, and being partially reflected, forms at *d*—the distance *ad* being equal to *ao*—an image of the wire, which the eye is enabled to observe by means of the eyepiece *P*. If the mirror, instead of being fixed, is moving slowly round—its axis being at right angles to the plane of the paper—there will be no sensible change in the position of the mirror *m* during the brief interval elapsing while light travels from *m* to *M* and back again, but the image will alternately disappear and reappear. If now the velocity of *m* is increased to upwards of 30 turns per second, the interval between the disappearance and reappearance is so short that the impression on the eye is persistent, and the image appears perfectly steady.

Lastly, if the mirror turns with sufficient velocity, there is no appreciable change in its position during the time which the light takes in making the double journey from *m* to *M*, and from *M* to *m*; the return ray, after its reflection from the mirror *m*, takes the direction *mb*, and forms its image at *i*; that is, the image has undergone a total deviation, *di*. Speaking precisely, there is a deviation as soon as the mirror turns, even slowly, but it is only appreciable when it has acquired a certain magnitude, which is the case when the velocity of rotation is sufficiently rapid, or the distance *Mm* sufficiently great, for the deviation necessarily increases with the time which the light takes in returning on its own path.

In *M. Foucault's* experiment the distance *Mm* was only  $13\frac{1}{2}$  feet; when the mirror rotated with a velocity of 600 to 800 turns in a second, deviations of  $\frac{2}{10}$  to  $\frac{3}{10}$  of a millimetre were obtained.

Taking *Mm* = *l*, *Lm* = *l'*, *oL* = *r*, and representing by *n* the number of turns in a second, by  $\delta$  the absolute deviation *di*, and by *V* the velocity of light, *M* Foucault arrived at the formula

$$V = \frac{8\pi^2 n r}{\delta(l + l')},$$

from which the velocity of light is calculated at 185,157 miles in a second; this number, which is less than that ordinarily assumed, agrees remarkably well with the value deduced from the new determinations of the value of the solar parallax.

In this apparatus liquids can be experimented upon. For that purpose a tube, *AB*, 10 feet long, and filled with distilled water, is placed between the turning mirror *m*, and a concave mirror *M'*, identical with the mirror *M*. The luminous rays reflected by the rotating mirror, in the direction *mM'*, traverse the column of water *AB* twice before returning to *V*. But the return



ray then becomes reflected at  $c$ , and forms its image at  $h$ : the deviation is consequently greater for rays which have traversed water than for those which have passed through air alone; hence the velocity of light is less in water than in air.

This is the most important part of these experiments. For it had been shown theoretically that on the undulatory theory the velocity of light must be less in the more highly refracting medium (620), while the opposite is a necessary consequence of the emission theory. Hence Foucault's result may be regarded as a crucial test of the validity of the undulatory theory.

The mechanism which M. Foucault uses to turn the mirror with great velocity consists of a small steam turbine, bearing a sort of resemblance to the syren, and, like that instrument, giving a higher sound as the rotation is more rapid; in fact, it is by the pitch of the note that the velocity of the rotation is determined.

493. **Experiments of M. Fizeau.**—In 1849 M. Fizeau measured directly the velocity of light, by ascertaining the time it took to travel from Suresnes to Montmartre and back again. The apparatus employed was a toothed wheel, capable of being turned more or less quickly, and with a velocity that could be exactly ascertained. The teeth were made of precisely the same width as the intervals between them. The apparatus being placed at Suresnes, a pencil of parallel rays was transmitted through an interval between two teeth to a mirror placed at Montmartre. The pencil, directed by a properly-arranged system of tubes and lenses, returned to the wheel. As long as the apparatus was at rest the pencil returned exactly through the same interval as that through which it first set out. But when the wheel was turned sufficiently fast, a tooth was made to take the place of an interval, and the ray was intercepted. By causing the wheel to turn more rapidly, it reappeared when the interval between the next two teeth had taken the place of the former tooth at the instant of the return of the pencil.

The distance between the two stations was 28,334 ft. By means of the data furnished by this distance, by the dimensions of the wheel, its velocity of rotation, etc., M. Fizeau found the velocity of light to be 196,000 miles per second, a result agreeing with that given by astronomical observation as closely as can be expected in a determination of this kind.

M. Cornu has recently investigated the velocity of light by M. Fizeau's method; but with improvements so that the probable error did not exceed  $\frac{1}{400}$  of the total amount; the two stations, which were 6.4 miles apart, were a pavilion of the École Polytechnique and a room in the barracks of Mont Valerien. He thus obtained the number 185,420 miles, a result closely agreeing with that of Foucault, and which is supported by calculations based on the results of astronomical observations of the transit of Venus in 1874.

494. **Laws of the intensity of light.**—The *intensity* of illumination is the quantity of light received on the unit of surface; it is subject to the following laws.—

I. *The intensity of illumination on a given surface is inversely as the square of its distance from the source of light.*

II. *The intensity of illumination which is received obliquely is proportional to the cosine of the angle which the luminous rays make with the normal to the illuminated surface.*

In order to demonstrate the first law, let there be two circular screens,

CD and AB (fig. 376), one placed at a certain distance from a source of light, L, and the other at double this distance, and let  $s$  and  $S$  be the

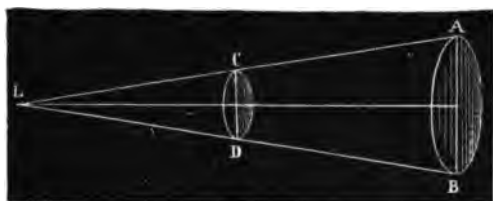

Fig. 376.

areas of the two screens. If  $a$  be the total quantity of light which is emitted by the source in the direction of the cone ALB, the intensity of the light on the screen CD, that is, the quantity which falls on the unit of surface, is  $\frac{a}{s}$ , and the intensity on the screen AB is  $\frac{a}{S}$ . Now, as the triangles ALB and CLD are similar, the diameter of AB is double that of CD; and as the surfaces of circles are as the squares of their diameters, the surface  $S$  is four times  $s$ , consequently the intensity  $\frac{a}{S}$  is one-fourth that of  $\frac{a}{s}$ .

The same law may also be demonstrated by an experiment with the apparatus represented in fig. 378. It is made by comparing the shadows of an opaque rod cast upon a glass plate, in one case by the light of a single candle, and in another by that of a lamp equalling four candles, placed at double the distance of the first. In both cases the shadows have the same intensity.

Figure 376 shows that it is owing to the divergence of the luminous rays emitted from the same source that the intensity of light is inversely as the square of the distance. The illumination of a surface placed in a beam of parallel luminous rays is the same at all distances, at any rate in a vacuum, for in air and in other transparent media the intensity of light decreases in consequence of absorption, but far more slowly than the square of the distance.

The second law of intensity corresponds to the law which we have found to prevail for heat: it may be theoretically deduced as follows: let

DA, EB (fig. 377) be a pencil of parallel rays falling obliquely on a surface, AB, and let  $om$  be the normal to this surface. If  $S$  is the section of the pencil,  $a$  the total quantity of light which falls on the surface AB, and  $I$  that which falls on the unit of surface (that is, the intensity of illumination), we



Fig. 377.

have  $I = \frac{a}{AB}$ . But as  $S$  is only the projection of AB on a plane per-

pendicular to the pencil, we know from trigonometry that  $S = AB \cos \alpha$ , from which  $AB = \frac{S}{\cos \alpha}$ . This value, substituted in the above equation, gives  $I = \frac{a}{S} \cos \alpha$ , a formula which demonstrates the law of the cosine, for as  $a$  and  $S$  are constant quantities,  $I$  is proportional to  $\cos \alpha$ .

The law of the cosine applies also to rays emitted obliquely by a luminous surface; that is, the rays are less intense in proportion as they are more inclined to the surface which emits them. In this respect they correspond to the third law of the intensity of radiant heat.

**495. Photometers.**—A *photometer* is an apparatus for measuring the relative intensities of light.

*Rumford's photometer.* This consists of a ground glass screen, in front of which is fixed an opaque rod (fig. 378); the lights to be compared—for



Fig. 378.

instance, a lamp and a candle—are placed at a certain distance in such a manner that each projects on the screen a shadow of the rod. The shadows thus projected are at first of unequal intensity, but by altering the position of the lamp, it may be so placed that the intensity of the two shadows is the same. Then, since the shadow thrown by the lamp is illuminated by the candle, and that thrown by the candle is illuminated by the lamp, the illumination of the screen due to each light is the same. The intensities of the two lights, that is, the illuminations which they would give at equal distances, are then directly proportional to the squares of their distances from the shadows; that is to say, that if the lamp is three times the distance of the candle, its illuminating power is nine times as great.

For if  $i$  and  $i'$  are the intensities of the lamp and the candle at the unit of distance, and  $d$  and  $d'$  their distances from the shadows, it follows, from the first law of the intensity of light, that the intensity of the lamp at the distance  $d$  is  $\frac{i}{d^2}$ , and that of the candle  $\frac{i'}{d'^2}$  at the distance  $d'$ . On the screen these two intensities are equal; hence  $\frac{i}{d^2} = \frac{i'}{d'^2}$  or  $\frac{i}{i'} = \frac{d'^2}{d^2}$  which was to be proved.

*Bunsen's photometer.*—When a grease spot is made on a piece of bibulous paper, the part appears translucent. If the paper be illuminated by a light placed in front, the spot appears darker than the surrounding space; if, on the contrary, it be illuminated from behind, the spot appears light on a dark ground. If the greased part and the rest appear unchanged, the intensity of illumination on both sides is the same. Bunsen's photometer depends on an application of this principle. A circular spot is made on a paper screen by means of a solution of spermaceti in naphtha: behind this is placed a light of a certain intensity, which serves as a standard; in this country it is usually a wax candle of known dimensions and weight. The light to be tested is then moved in a right line to such a distance in front of the diaphragm that there is no difference in brightness between the greased part and the rest of the screen. By measuring the distances of the lights from the screen, their relative illuminating powers are deduced from what has been previously said.

By this kind of determination no very great degree of accuracy can be attained, more especially when the lights to be compared are of different colours, one, for instance, being yellow, and the other of a bluish tint. It gives, however, results which are sufficiently accurate for practical purposes, and is almost universally employed for determining the illuminating power of coal gas and other artificial lights.

*Wheatstone's photometer.*—The principal part of this instrument is a steel bead, P (fig. 379), fixed on the edge of a disc, which rotates on a



Fig. 379.



Fig. 380.

pinion,  $o$ , working in a larger toothed wheel. The wheel fits in a cylindrical brass box, which is held in one hand, while the other works a handle, A, which turns a central axis, the motion of which is transmitted by a spoke,  $a$ , to the pinion  $o$ . In this way the latter turns on itself, and at the same time revolves round the circumference of the box; the bead shares the double motion, and consequently describes a curve in the form of a rose (fig. 380).

Now, let M and N be the two lights whose intensities are to be compared; the photometer is placed between them and rapidly rotated. The brilliant points produced by the reflection of the light on the two opposite sides of the bead give rise to two luminous bands, arranged as represented in fig. 380. If one of them is more brilliant than the other—that which proceeds from the light M, for instance—the instrument is brought nearer the other light until the two bands exhibit the same brightness. The distance of the photometer from each of the two lights being then measured, their intensities are proportional to the squares of the distances.

496. **Relative intensities of various sources of light.**—The light of the sun is 600,000 times as powerful as that of the moon ; and 16,000,000,000 times as powerful as that of a *Centauri*, the third in brightness of all the stars. The moon is thus 27,000 times as bright as this star ; the sun is 5,000 million times as bright as Jupiter and 80 billion times as bright as Neptune. It is estimated to be equal to that of 5,500 wax candles at a distance of 1 foot. According to Fizeau and Foucault the electric light produced by 50 Bunsen's cells is about  $\frac{1}{4}$  as strong as sunlight.

A difference in the strength of light or shadow is perceived when the duller light is  $\frac{59}{60}$  of the brightness of the other, and both are near together, especially when the shadow is moved about.

## CHAPTER II.

### REFLECTION OF LIGHT. MIRRORS.

497. **Laws of the reflection of light.**—When a luminous ray meets a polished surface, it is reflected according to the following two laws, which, as we have seen, also prevail for heat :—

I. *The angle of reflection is equal to the angle of incidence.*

II. *The incident and the reflected ray are both in the same plane, which is perpendicular to the reflecting surface.*

The words are here used in the same sense as in article 399, and need no further explanation.

*First proof.*—The two laws may be demonstrated by the apparatus represented in fig. 381. It consists of a graduated circle in a vertical plane. Two brass slides move round the circumference ; on one of them there is a piece of ground glass, P, and on the other an opaque screen, N, in the centre of which is a small aperture. Fixed to the latter slide there is also a mirror, M, which can be more or less inclined, but always remains in a plane perpendicular to the plane of the graduated circle. Lastly, there



Fig. 381.

is a small polished metallic mirror, *m*, placed horizontally in the centre of the circle.

In making the experiment, a pencil of solar light, *S*, is caused to impinge on the mirror *M*, which is so inclined that the reflected light passes through the aperture in *N*, and falls on the centre of the mirror *m*. The luminous pencil then experiences a second reflection in a direction *mP*,

which is ascertained by moving  $P$  until an image of the aperture is found in its centre. The number of degrees comprised in the arc  $AN$  is then read off, and likewise that in  $AP$ ; these being equal, it follows that the angle of reflection  $AmP$  is equal to the angle of incidence  $AmM$ .

The second law follows from the arrangement of the apparatus, the plane of the rays  $Mm$  and  $mP$  being parallel to the plane of the graduated circle, and, consequently, perpendicular to the mirror  $m$ .

*Second Proof.*—The law of the reflection of light may also be demonstrated by the following experiment, which is susceptible of greater accuracy than that just described. In the centre of a graduated circle,  $M$  (fig. 382),

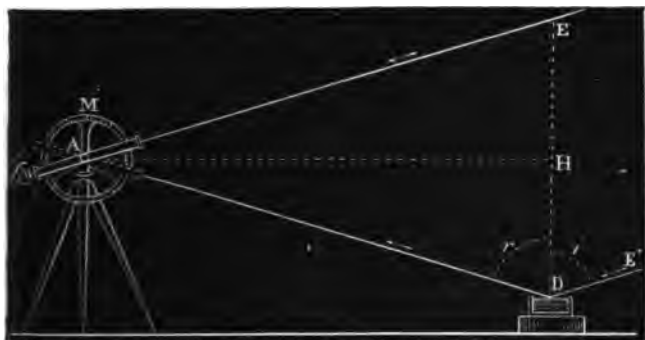

Fig. 382.

placed in a vertical position, there is a small telescope movable in a plane parallel to the limb; at a suitable distance there is a vessel full of mercury, which forms a perfectly horizontal plane mirror. Some particular star of the first or second magnitude is viewed through the telescope in the direction  $AE$ , and the telescope is then inclined so as to receive the ray  $AD$  coming from the star after being reflected from the brilliant surface of the mercury. In this way the two angles formed by the rays  $EA$  and  $DA$ , with the horizontal  $AH$ , are found to be equal, from which it may easily be shown that the angle of incidence  $E'DE$  is equal to the angle of reflection  $EDA$ . For if  $DE$  is the normal to the surface of the mercury, it is perpendicular to  $AH$ , and  $AED$ ,  $ADE$  are the complements of the equal angles  $EAH$ ,  $DAH$ ; therefore  $AED$ ,  $ADE$  are equal; but the two rays  $AE$  and  $DE'$  may be considered parallel, in consequence of the great distance of the star, and therefore the angles  $EDE'$  and  $DEA$  are equal, for they are alternate angles, and, consequently, the angle  $E'DE$  is equal to the angle  $EDA$ .

#### REFLECTION OF LIGHT FROM PLANE SURFACES.

498. **Mirrors. Images.**—*Mirrors* are bodies with polished surfaces which show by reflection objects presented to them. The place at which objects appear is their *image*. According to their shape, mirrors are divided into *plane, concave, convex, spherical, parabolic, conical*, etc.

499. **Formation of images by plane mirrors.**—The determination of the position and size of images resolves itself into investigating the images of a series of points. And first, the case of a single point,  $A$ , placed before a plane mirror,  $MN$  (fig. 383), will be considered. Any ray,  $AB$ , incident from this point on the mirror, is reflected in the direction  $BO$ , making the angle of reflection  $DBO$  equal to the angle of incidence  $DBA$ .

If, now a perpendicular,  $AN$ , be let fall from the point  $A$  on the mirror, and if the ray  $OB$  be prolonged below the mirror until it meets this perpendicular in the point  $a$ , two triangles are formed,  $ABN$  and  $BNa$ , which are equal, for they have the side  $BN$  common to both, and the angles  $ANB$ ,  $ABN$ , equal to the angles  $aNB$ ,  $aBN$ ; for the angles  $ANB$  and  $aNB$  are right angles, and the angles  $ABN$  and  $aBN$  are each equal to the angle  $OBM$ . From the equality of these triangles, it follows that  $aN$  is equal to  $AN$ ; that is,



Fig. 383.



Fig. 384.

that any ray,  $AB$ , takes such a direction after being reflected, that its prolongation below the mirror cuts the perpendicular  $Aa$  in the point  $a$ , which is at the same distance from the mirror as the point  $A$ . This applies also to the case of any other ray from the point  $A$ — $AC$ , for example. From this the important consequence follows, that all rays from the point  $A$ , reflected from the mirror, follow, after reflection, the same direction as if they had all proceeded from the point  $a$ . The eye is deceived, and sees the point  $A$  at  $a$ , as if it were really situated at  $a$ . Hence in plane mirrors the image of any point is formed behind the mirror at a distance equal to that of the given point, and on the perpendicular let fall from this point on the mirror.

It is manifest that the image of any object will be obtained by constructing according to this rule the image of each of its points, or, at least, of those which are sufficient to determine its form. Fig. 384 shows how the image  $ab$  of any object,  $AB$ , is formed.

It follows from this construction that in plane mirrors the image is of the same size as the object, for if the trapezium  $ABCD$  be applied to the trapezium  $DCab$ , they are seen to coincide, and the object  $AB$  agrees with its image.

A further consequence from the above construction is, that in plane mirrors the image is symmetrical in reference to the object, and not inverted.

500. **Virtual and real images.**—There are two cases relative to the direction of rays reflected by mirrors according as the rays after reflection are convergent or divergent. In the first case the reflected rays do not meet, but if they are supposed to be produced on the other side of the mirror, their

prolongations coincide in the same point, as shown in figs. 383 and 384. The eye is then affected, just as if the rays proceeded from this point, and it sees an image. But the image has no real existence, the luminous rays do not come from the other side of the mirror; this appearance is called the *virtual image*. The images of real objects produced by plane mirrors are of this kind.

In the second case, where the reflected rays converge, of which we shall soon have an example in concave mirrors, the rays coincide at a point in front of the mirror, and on the same side as the object. They form there an image called the *real image*, for it can be received on a screen. The distinction may be expressed by saying that *real images are those formed by the reflected rays themselves, and virtual images those formed by their prolongations*.

501. **Multiple images formed by glass mirrors.**—Metallic mirrors which have but one reflecting surface only give one image; glass mirrors give rise to several images, which are readily observed when the image of a candle is looked at obliquely in a looking-glass. A very feeble image is first seen, and then a very distinct one; behind this there are several others, whose intensities gradually decrease until they disappear.

This phenomenon arises from the looking-glass having two reflected surfaces. When the rays from the point A meet the first surface, a part is reflected and forms an image, *a*, of the point A, on the prolongation of the ray *bE*, reflected by this surface; the other part passes into the glass, and is reflected at *c*, from the layer of metal which covers the hinder surface of the glass, and reaching the eye in the direction *dH* gives the image *a'*. This image is distant from the first by double the thickness of the glass. It is more intense, because metal reflects better than glass.



Fig. 385.

In regard to other images it will be remarked, that whenever light is transmitted from one medium to another—for instance, from glass to air—only some of the rays get through, the remainder are reflected at the surface which bounds the two media. Consequently when the pencil *cd*, reflected from *c*, attempts to leave the glass at *d*, most of the rays composing it pass into the air, but some are reflected at *d*, and continue within the glass. These are again reflected by the metallic surface, and form a third image of A; after this reflection they come to MN, when many emerge and render the third image visible, but some are again reflected within the glass, and in a similar manner give rise to a fourth, fifth, etc., image, thereby completing the series above described. It is manifest from the above explanation that each image must be much feebler than the one preceding it, and consequently not more than a small number are visible—ordinarily not more than eight or ten in all.

This multiplicity of images is objectionable in observations, and accordingly, metallic mirrors are preferable in optical instruments.

502. **Multiple images from two plane mirrors.**—When an object is placed between two plane mirrors, which form an angle with each other,



either right or acute, images of the object are formed, the number of which increases with the inclination of the mirrors. If they are at right angles to each other, three images are seen, arranged as represented in fig. 386. The rays OC and OD from the point O, after a single reflection, give the one an image O', and the other an image O'', while the ray OA, which has undergone two reflections at A and B, gives the third image, O'''.

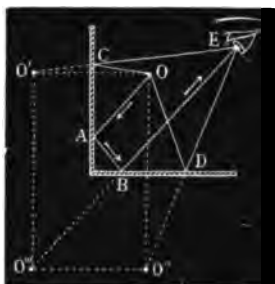

Fig. 386.

When the angle of the mirrors is  $60^\circ$ , five images are produced, and seven if it is  $45^\circ$ . The number of images continues to increase in proportion as the angle diminishes, and when it is zero—that is, when the mirrors are parallel—the number of images is theoretically infinite. This multiplicity arises from the fact that the luminous rays undergo an increasing number of reflections from one mirror to the other.

The *kaleidoscope*, invented by Sir D. Brewster, depends on this property of inclined mirrors. It consists of a tube, in which are three mirrors inclined at  $60^\circ$ ; one end of the tube is closed by a piece of ground glass, and the other by a cap provided with an aperture. Small irregular pieces of coloured glass are placed at one end between the ground glass

and another glass disc, and on looking through the aperture, the other end being held towards the light, the objects and their images are seen arranged in beautiful symmetrical forms; by turning the tube an endless variety of these shapes is obtained.

**503. Multiple images in two parallel mirrors.**—In this case the number of images of an object placed between them is theoretically infinite. Physically the number is limited, for as the incident light is never totally reflected, some of it being always absorbed, the images gradually become fainter, and are ultimately quite extinguished.

Fig. 387 shows how the pencil La reflected once from M gives at I the image of the object L at a distance  $MI = ML$ ; then the pencil Lb reflected once from the mirror M, and once from N, furnishes the image I' at a distance  $nI' = nI$ ; in like manner the pencil Lc after two reflections on M, and one on N forms the image I'' at a distance  $mI'' = mI'$  and so on for an infinite series. The images  $i, i', i''$ , are formed in the same manner by rays of light, which emitted by the object L fall first on the mirror N.

**504. Irregular reflection. Diffused light.**—The reflection from the surfaces of polished bodies, the laws of which have just been stated, is called the *regular* or *specular reflection*; but the quantity thus reflected is less than the incident light. The light incident on an opaque body actually separates into three parts: one is reflected *regularly*, another *irregularly*, that is, in all directions; while a third is extinguished, or *absorbed* by the reflecting body. If light falls on a transparent body, a considerable portion is transmitted with regularity.

The irregularly reflected light is called *scattered light*: it is that which makes bodies visible. The light which is reflected regularly does not give us the images of the reflecting surface, but that of the body from which the

light proceeds. If, for example, a beam of sunlight be incident on a well-polished mirror in a dark room, the more perfectly the light is reflected the less visible is the mirror in the different parts of the room. The eye does

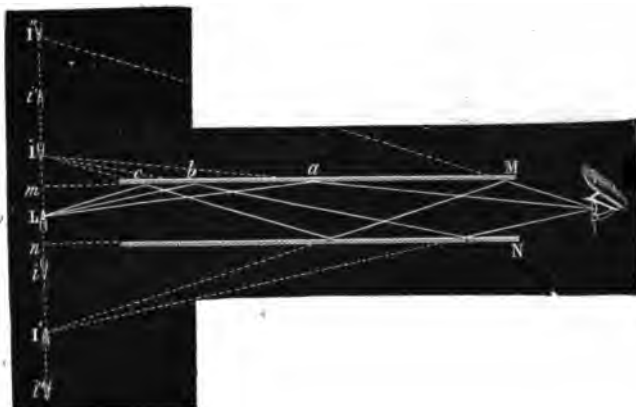

Fig. 387.

not perceive the image of the mirror, but that of the sun. If the reflecting power of the mirror be diminished by sprinkling on it a light powder, the solar image becomes feebler, and the mirror is visible from all parts of the room. Perfectly smooth, polished reflecting surfaces, if such there were, would be invisible. The air diffuses the light which falls on it from the sun in all directions, so that it is light in places which do not receive the direct rays of the sun. Thus the upper layers of the air diffuse the light which they receive before sunrise and sunset, and accordingly give rise to the phenomenon of *twilight*.

**505. Intensity of reflected light.**—The intensity of the reflecting power of a body increases with the degree of polish and with the obliquity of the incident ray. For instance, if a sheet of white paper be placed before a candle, and be looked at very obliquely, an image of the flame is seen by reflection, which is not the case if the eye receives less oblique rays.

The intensity of the reflection varies with different bodies, even when the degree of polish and the angle of incidence are the same. It also varies with the nature of the medium which the ray is traversing before and after reflection. Polished glass immersed in water loses a great part of its reflecting power.

**506. Reflection of a ray of light in a rotating mirror.**—When a horizontal ray of light falls on a plane mirror which can rotate about a vertical axis, if the mirror is turned through an angle  $a$ , the reflected ray is turned through double the angle.

Let  $mn$  (fig. 387) be the first position of the mirror,  $m'n'$  its position after it has been turned through the angle  $a$ : and let  $OD$  be the fixed incident ray. If from the centre of rotation  $C$ , with any radius we describe the circumference  $Omn$ , and from the point  $O$ , where it cuts the incident ray,

chords  $OO'$  and  $OO''$  are drawn perpendicular respectively to  $mn$  and  $m'n'$ ; the points  $O'$  and  $O''$  are the images of the point  $O$  in the two positions of the mirror, and the angles  $CO'D$  and  $CO''D'$  are each equal to  $COD$ . The lines  $O'D$  and  $O''D'$ , thus making equal angles with  $O'C$  and  $O''C$ , the angle between the two former lines is equal to that between the two latter, that is it will be equal to  $O'CO''$  and will be measured by the arc  $O'O''$ . The rotations of the reflected ray and of the mirror are thus measured by the two arcs  $O'O''$  and  $mm'$  respectively.

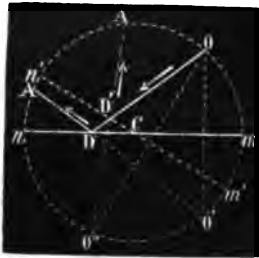

Fig. 388.

Now the two angles  $O'OO''$  and  $mCm'$  are equal, for they have their sides perpendicular each to each; but the angle  $O'OO''$ , which is an angle at the circumference, is measured by half the arc  $O'O''$ , and the angle  $mCm'$  by the whole arc  $mm'$ ; hence  $O'O''$  is the double of  $mm'$ , which shows that when the mirror has turned through an angle  $a$ , the reflected ray has turned through  $2a$ .

507. **Hadley's reflecting sextant.**—The principal features of this instrument, which is used to measure the angular distance of any two distant objects, are represented in fig. 389. It consists of a metal sector, the arc,  $cd$ ,

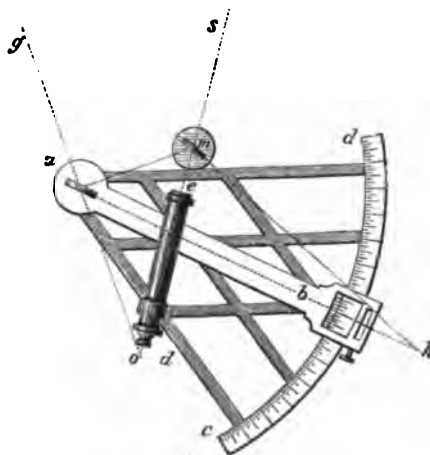

Fig. 389.

of which is graduated. About the centre of the sector, an index arm,  $ab$ , turns; this is provided with a vernier and a micrometer screw, by which the index may be accurately adjusted and also clamped. A mirror at  $a$  is fixed perpendicularly to the arm  $ab$ , and therefore moves with it. A telescope  $de$  is permanently fixed to the arm  $ac$  and opposite to it is a second mirror  $m$ , also permanently fixed; the lower half of this is silvered, and the axis of the telescope just traverses the boundary of the silvered and unsilvered part of the mirror.

In making an observation the sextant is held so that its plane may pass

through both the objects whose angular distance is to be measured. The index arm is at the zero of the graduation, which indicates the parallelism of the two mirrors. One of the objects is then viewed in the direction  $om$ , through the telescope and the unsilvered part of the mirror  $m$ . The index arm is then moved until the eye sees simultaneously with this the image of another object  $g$ , which reaches the eye after successive reflections from the mirror  $a$ , and from the unsilvered part of the mirror  $m$ ; that is, by the path  $g, a, m, e, d, o$ . The angle  $mha$  which the two mirrors now form is measured by the graduation of the sector  $el$ , and is half the angle  $gom$ . For when the two mirrors were parallel, the angular deflection of the ray  $ga$ , after two reflections, would be zero, and its deflection is now the angle  $gcm$ ; whence by the last article the mirror  $a$  must have turned through half that angle, the mirror  $m$  having been fixed in position throughout.

508. **Measurement of small angles by reflection from a mirror.**—An important application is made of the law of reflection in measuring small angles of deflection in magnetic and other observations. The principle of this method will be understood from fig. 390, in which  $AO$  represents a

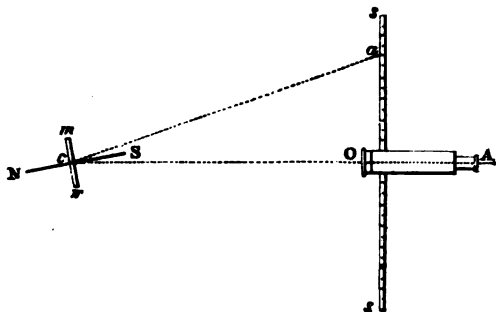

Fig. 390.

telescope, underneath which, and at right angles to its axis, is fixed a graduated scale  $ss$ ; the centre of which, the zero, corresponds to the axis of the telescope.

Let  $NS$  be the object whose angular deflection is to be measured, a magnet for instance, and let  $mm$  represent a small perfectly plane mirror fixed rigidly at right angles to the axis of the magnet. If now at the beginning of the observation, the telescope is adjusted so that the image of the zero appears behind the cross wires its axis is perpendicular to the mirror. Now when the mirror is turned by whatever cause through an angle  $a$ , the eye will see through the telescope the image of another division of the scale  $a$  for instance, the ray proceeding from which makes with the line  $cOA$  the angle  $2a$ .

From the distance of this division  $Oa$  from the zero of the scale and the distance  $Oc$  from the mirror we have  $\tan 2a = \frac{Oa}{oc}$ . Thus, for instance, if  $Oa$

is 12 millimetres and  $oc$  5,000 millimetres, then  $\tan 2a = \frac{12}{5,000}$  from which

$2a = 8' 15''$ . As a practised eye can easily read  $\frac{1}{10}$  of a millimetre, it is possible by such an arrangement to read off an angular deflection of two seconds.

509. **Mance's Heliograph.**—The reflection of light from mirrors has been lately applied by Mance in signalling at great distances by means of the sun's light.

The apparatus consists essentially of a mirror about 4 inches in diameter mounted on a tripod, and provided with suitable adjustments so that the sun's light can be received upon it and reflected to a distant station. An observer then can see through a telescope the reflection of the sun's rays as a spot of light. The mirror has an adjustment by which it can be made to follow the sun in its apparent motion. There is also a lever-key by which the signaller can deflect the mirror, through a very small angle either to the right or left, and thus the observer at the distant station sees corresponding flashes to the right or left. Under the subject of Telegraphy, it will be seen how these alternate motions can be used to form an alphabet.

Of course this mode of signalling can only be used where the sun's light is available, but it has the advantage of being cheap, simple, and portable. Signals have been sent at the rate of 12 words a minute, through distances, in very fine weather, of 40 miles.

#### REFLECTION OF LIGHT FROM CURVED SURFACES.

510. **Spherical mirrors.**—It has been already stated (498) that there are several kinds of curved mirrors; those most frequently employed are spherical and parabolic mirrors.

*Spherical mirrors* are those whose curvature is that of a sphere; their surface may be supposed to be formed by the revolution of an arc MN (fig. 391), about the radius CA, which unites the middle of the arc to the centre of the circle of which it is a part. According as the reflection takes place from the internal or from the external face of the mirror it is said to be *concave* or *convex*. C, the centre of the hollow sphere, of which the mirror forms part, is called the *centre of curvature* or *geometrical centre*: the point A is the centre of the figure. The infinite right line, AL, which passes through A and C, is the *principal axis* of the mirror: any right line which simply passes through the centre C, and not through the point A, is a *secondary axis*. The angle MCN, formed by joining the centre and extremities of the mirror, is the *aperture*. A *principal* or *meridional section* is any section made by a plane through its principal axis. In speaking of mirrors those lines alone will be considered which lie in the same principal section.

The theory of the reflection of light from curved mirrors is easily deduced from the laws of reflection from plane mirrors, by considering the surface of the former as made up of an infinitude of extremely small plane surfaces, which are its *elements*. The normal to the curved surface at a given point is the perpendicular to the corresponding element, or, what is the same thing, to its corresponding tangent plane. It is shown in geometry that in spheres all the normals pass through the centre of curvature, so that the normal may readily be drawn to any point of a spherical mirror.

511. **Focus of a spherical concave mirror.**—In a curved mirror the *focus* is a point in which the reflected rays meet or tend to meet if produced

either backwards or forwards ; there may either be a *real focus* or a *virtual focus*.

*Real focus.*—We shall first consider the case in which the luminous rays are parallel to the principal axis, which presupposes that the luminous body is at an infinite distance ; let GD (fig. 391) be such a ray.

From the hypothesis that curved mirrors are composed of a number of infinitely small plane elements, this ray would be reflected from the element

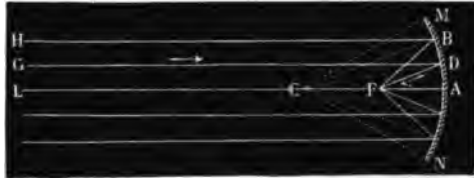

Fig. 391.

corresponding to the point D, according to the laws of the reflection from plane mirrors, (497) ; that is, that CD being the normal at the point of incidence D, the angle of reflection CDF is equal to the angle of incidence GDC, and is in the same plane. It follows from this that the point F, where the reflected ray cuts the principal axis, divides the radius of curvature AC very nearly into two equal parts. For in the triangle DFC, the angle DCF is equal to the angle CDG, for they are alternate and opposite angles ; likewise the angle CDF is equal to the angle CDG, from the laws of reflection ; therefore the angle FDC is equal to the angle FCD, and the sides FC and FD are equal as being opposite to equal angles. Now the smaller the arc, AD, the more nearly does DF equal AF ; and when the arc is only a small number of degrees, the right lines AF and FC may be taken as approximately equal, and the point F may be taken as the middle of AC. So long as the aperture of the mirror does not exceed 8 to 10 degrees, any other ray, HB, will after reflection pass very nearly through the point F. Hence, when a pencil of rays parallel to the axis falls on a concave mirror, the rays intersect after reflection in the same point, which is at an equal distance from the centre of curvature and from the mirror. This point is called the *principal focus* of the mirror, and the distance AF is the *principal focal distance*.

All rays parallel to the axis meet in the point F ; and, conversely, if a luminous object be placed at F, the rays emitted by this object will after reflection take the directions DG, BH, parallel to the principal axis ; for in this case the angles of incidence and reflection have changed places ; but these angles always remain equal.

The case is now to be considered in which the rays are emitted from a luminous point, L (fig. 392), placed on the principal axis, but at such a distance that they are not parallel, but divergent. The angle LKC, which the incident ray LK forms with the normal KC, is smaller than the angle SKC, which the ray SK parallel to the axis forms with the same normal, and, consequently, the angle of reflection corresponding to the ray LK must be smaller than the angle CKF, corresponding to the ray SK. And, therefore, the ray LK will meet the axis after reflection at a point, *l*, between the centre

C and the principal focus F. So long as the aperture of the mirror does not exceed a small number of degrees, all the rays from the point L will intersect after reflection in the point  $l$ . This point is called the *conjugate focus*; for there is this connection between the points L and  $l$ , that if the luminous point were transferred to  $l$ , its conjugate focus would be at L,  $IK$  being the incident and  $KL$  the reflected ray.

On considering the figure 392 it will be seen that when the object L is brought near to or removed from the centre C, its conjugate focus approaches



Fig. 392.

or recedes in a corresponding manner, for the angles of incidence and reflection increase or decrease together.

If the object L coincides with the centre C, the angle of incidence is null, and as the angle of reflection must be the same, the ray is reflected on itself, and the focus coincides with the object. When the luminous object is between the centre C and the principal focus, the conjugate focus in turn is on the other side of the centre, and is further from the centre according as the luminous point is nearer the principal focus. If the luminous point coincides with the principal focus, the reflected rays, being parallel to the axis, will not meet, and there is, consequently, no focus.

*Virtual focus.*—There is, lastly, the case in which the object is placed at L, between the principal focus and the mirror (fig. 393). Any ray, LM,

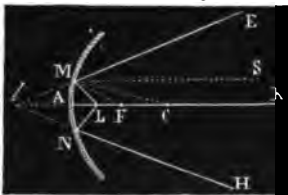

Fig. 393.

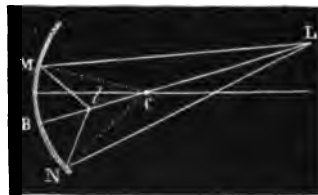

Fig. 394.

emitted from the point L, makes with the normal CM an angle of incidence,  $LMC$ , greater than  $FMC$ ; the angle of reflection must be greater than  $CMS$ , and therefore the reflected ray  $ME$  diverges from the axis  $AK$ . This is also the case with all rays from the point L, and hence these rays do not intersect, and, consequently, form no conjugate focus; but if they are conceived to be prolonged on the other side of the mirror, their prolongations will intersect in the same point,  $l$ , on the axis, and the eye experiences the same impression as if the rays were emitted from the point  $l$ . Hence a *virtual focus* is formed quite analogous to those formed by plane mirrors (510).

In all these cases it is seen that the position of the principal focus is constant, while that of the conjugate foci and of the virtual foci vary. *The principal and the conjugate foci are always on the same side of the mirror as the object, while the virtual focus is always on the other side of the mirror.*

Hitherto the luminous point has always been supposed to be placed on the principal axis itself, and then the focus is formed on this axis. In the case in which the luminous point is situated on a secondary axis, LB (fig. 394), by applying to this axis the same reasoning as in the preceding case, it will be seen that the focus of the point L is formed at a point *l*, on the secondary axis, and that, according to the distance of the point L, the focus may be either principal, conjugate, or virtual.

512. **Foci of convex mirrors.**—In convex mirrors there are only virtual foci. Let SI, TK . . . (fig. 395) be rays parallel to the principal axis of a

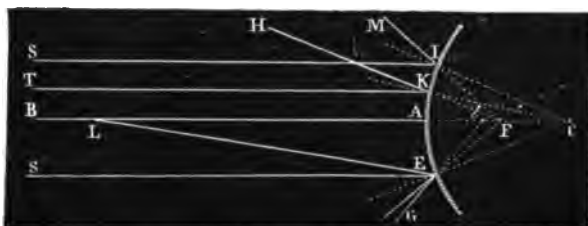

Fig. 395.

convex mirror. These rays, after reflection, take the diverging directions IM, KH, which, when continued, meet in a point, F, which is the *principal virtual focus* of the mirror. By means of the triangle CKF, it may be shown, in the same manner as with concave mirrors, that the point F is approximately the middle of the radius of curvature, CA.

If the incident luminous rays, instead of being parallel to the axis, proceed from a point, L, situated on the axis at a finite distance, it is at once seen that a virtual focus will be formed at a point *l*, between the principal focus F and the mirror.

513. **Determination of the principal focus.**—In the applications of concave and convex mirrors, it is often necessary to know the radius of curvature. This is tantamount to finding the principal focus; for being situated at the middle of the radius, it is simply necessary to double the focal distance.

To find this focus with a concave mirror, it is exposed to the sun's rays, so that its principal axis is parallel to them, and then with a small screen of ground glass the point is sought at which the image is formed with the greatest intensity; this is the principal focus. The radius of the mirror is double this distance.

If the mirror is convex it is covered with paper, but two small portions, H and I, are left exposed at equal distances from the centre of the figure A, and on the same principal section (fig. 396). A screen, MN, in the centre of which is an opening larger than the distance HI, is placed before the



mirror. If a pencil of solar rays,  $SH, S'I$ , parallel to the axis, fall on the mirror, the light is reflected at  $H$  and  $I$ , on the parts where the mirror is left exposed, and forms on the screen two brilliant images at  $h$  and  $i$ . By moving the screen  $MN$  nearer to or farther from the mirror, a position is

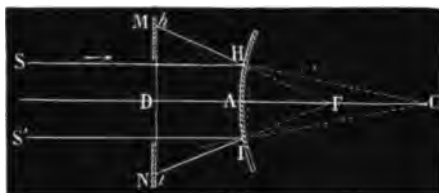

Fig. 396.

found at which the distance  $hi$  is double that of  $HI$ . The distance  $AD$  from the screen to the mirror then equals the principal focal distance. For the arc  $HAI$  does not sensibly differ from its chord, and because the triangles  $FHI$  and  $Fhi$  are similar,  $\frac{HI}{hi} = \frac{FA}{FD}$ ; but  $HI$  is half of  $hi$ , and therefore also  $FA$  is the half of  $FD$ , and therefore  $AD$  is equal to  $AF$ . Further,  $FA$  is the principal focal distance; for the rays  $SH$  and  $S'I$  are parallel to the axis: consequently also twice the distance  $AD$  equals the radius of curvature of the mirror.

**514. Formation of images in concave mirrors.**—Hitherto it has been supposed that the luminous or illuminated object placed in front of the mirror was simply a point; but if this object has a certain magnitude, we can conceive a secondary axis drawn through each of its points, and thus a series of real or virtual foci could be determined, the collection of which composes the image of the object. By the aid of the constructions which have served for determining the foci, we shall investigate the position and magnitude of these images in concave and in convex mirrors.

*Real image.*—We shall first take the case in which the mirror is concave, and the object  $AB$  (fig. 397) is on the other side of the centre. To obtain

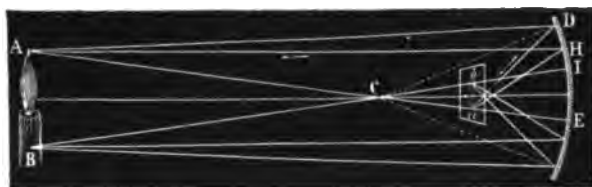

Fig. 397.

the image or the focus of any point,  $A$ , a secondary axis,  $AE$ , is drawn from this point, and then drawing from the point  $A$  an incident ray,  $AD$ , the normal to this point,  $CD$ , is taken, and the angle of reflection  $CDa$  is made equal to the angle of incidence  $ADC$ . The point  $a$ , where the reflected ray

cuts the secondary axis  $AE$ , is the conjugate focus of the point  $A$ , because every other ray drawn from this point passes through with  $a$ . Similarly if a secondary axis,  $BI$ , be drawn from the point  $B$ , the rays from this point meet after reflection in  $b$ , and form the conjugate focus of  $B$ . And as the images of all the points of the object are formed between  $a$  and  $b$ ,  $ab$  is the complete image of  $AB$ . From what has been said about foci (511), it appears that *this image is real, inverted, smaller than the object, and placed between the centre of curvature and the principal focus*. This image may be seen in two ways; by placing the eye in the continuation of the reflected rays, and then it is an aerial image which is seen; or the rays are collected on a screen, on which the image appears to be depicted.

If the luminous or illuminated object is placed at  $ab$ , between the principal focus and the centre, its image is formed at  $AB$ . It is then a real but inverted image; it is larger than the object, and *the larger as the object,  $ab$ , is nearer the focus*.

If the object is placed in the principal focus itself, no image is produced; for then the rays emitted from each point form, after reflection, as many pencils respectively parallel to the secondary axis, which is drawn through the point from which they are emitted (511), and hence neither foci nor images are formed.

When all points of the object  $AB$  are above the principal axis (fig. 398),

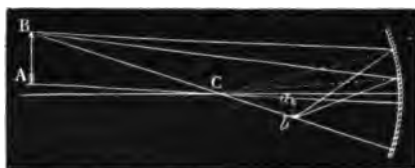

Fig. 398.

by repeating the preceding construction, it is readily seen that the image of the object is formed at  $ab$ .

*Virtual image.*—The case remains in which the object is placed between the principal focus and the mirror. Let  $AB$  be this object (fig. 399); the

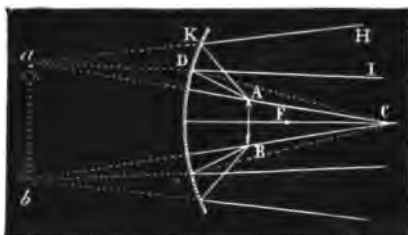

Fig. 399.

incident rays after reflection take the directions  $DI$  and  $KH$ , and their prolongations form a virtual image,  $a$ , of the point  $A$ , on the secondary axis.

Similarly, an image of B is formed at  $b$ , consequently the eye sees at  $ab$  the image of AB. *This image is virtual, erect, and larger than the object.*

From what has been stated, it is seen that, according to the distance of the object, concave mirrors produce two kinds of images, or none at all; a person notices this by placing himself before a concave mirror. At a certain distance he sees an image of himself inverted and smaller; this is the real image: at a less distance the image becomes confused, and disappears when he is at the focus; still nearer the image appears erect, but larger—it is then a virtual image.

515. **Formation of images in convex mirrors.**—Let AB (fig. 400) be an object placed before a mirror at any given distance. AC and BC are

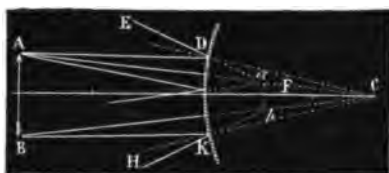

Fig. 400.

secondary axes, and it follows, from what has been already stated, that all the rays from A are divergent after reflection, and that their prolongations pass through a point,  $a$ , which is the virtual image of the point A. Similarly the rays from B form a virtual image of it in the point  $b$ . The eye which receives the divergent rays DE, KA, . . . sees in  $ab$  an image of AB. Hence, whatever the position of an object before a convex mirror, *the image is always virtual, erect, and smaller than the object.*

516. **Formulae for spherical mirrors.**—The relation between the position of an object and that of its image in spherical mirrors may be expressed by a very simple formula. In the case of concave mirrors, let R be its radius of curvature,  $p$  the distance LA of the object, L (fig. 401),



Fig. 401.

and  $p'$  the distance  $IA$  of the image from the mirror. In the triangle  $LM'I$ , the normal  $MC$  divides the angle  $LM'I$  in two equal parts, and from geometry it follows that the two segments  $LC, C'I$  are to each other as the two sides containing the angle; that is,  $\frac{C'I}{CL} = \frac{IM}{LM}$ ; therefore  $C'I \times LM = CL \times IM$ .

If the arc  $AM$  does not exceed 5 or 6 degrees, the lines  $ML$  and  $M'I$  are approximately equal to  $AL$  and  $A'I$ ; that is, to  $p$  and  $p'$ .

Further,  $C'I = CA - A'I = R - p'$ ,

and also  $CL = AL - AC = p - R$ .

The values substituted in the preceding equations give

$$\begin{aligned}(R - \phi') \phi &= (\phi - R) \phi', \\ R\phi - \phi\phi' &= \phi\phi' - R\phi'.\end{aligned}$$

From which transposing and reducing we have

$$R\phi + R\phi' = 2\phi\phi' \quad \dots \quad (1)$$

If the terms of this equation be all divided by  $\phi\phi'R$ , we obtain

$$\frac{1}{\phi'} + \frac{1}{\phi} = \frac{2}{R} \quad \dots \quad (2)$$

which is the usual form of the equation.

From the equation (1) we get

$$\phi' = \frac{\phi R}{2\phi - R} \quad \dots \quad (3)$$

which gives the distance of the image from the mirror, in terms of the distance of the object, and of the radius of curvature.

517. **Discussion of the formulae for mirrors.**—We shall now investigate the different values of  $\phi'$ , according to the values of  $\phi$  in the formula (3).

i. Let the object be placed at an infinite distance on the axis, in which case the incident rays are parallel. To obtain the value of  $\phi'$ , both terms of the fraction (3) must be divided by  $\phi$ , which gives

$$\phi' = \frac{R}{2 - \frac{R}{\phi}} \quad \dots \quad (4)$$

as  $\phi$  is infinite,  $\frac{R}{\phi}$  is zero, and we have  $\phi' = \frac{R}{2}$ ; that is, the image is formed in the principal focus, as ought to be the case, for the incident rays are parallel to the axis.

ii. If the object approaches nearer the mirror,  $\phi$  decreases, and as the denominator of the formula (4) diminishes, the value of  $\phi'$  increases; consequently the image approaches the centre at the same time as the object, but it is always between the principal focus and the centre, for so long as

$$\phi \text{ is } > R, \text{ we have } \frac{R}{2 - \frac{R}{\phi}} > \frac{R}{2} \text{ and } < R.$$

iii. When the object coincides with the centre,  $\phi = R$ , and, consequently  $\phi' = R$ ; that is, the image coincides with the object.

iv. When the luminous object is between the centre and the principal focus,  $\phi < R$ , and hence from the formula (4),  $\phi' > R$ ; that is, the image is formed on the other side of the centre. When the object is in the focus,  $\phi = \frac{R}{2}$ , which gives  $\phi' = \frac{R}{0} = \infty$ ; that is, the image is at an infinite distance, for the reflected rays are parallel to the axis.

v. Lastly, if the object is between the principal focus and the mirror, we get  $\phi < \frac{R}{2}$ ;  $\phi'$  is then negative, because the denominator of the formula (4)

is negative. Therefore, the distance  $p'$  of the mirror from the image must be calculated on the axis in a direction opposite to  $p$ . The image is then virtual, and is on the other side of the mirror.

Making  $p'$  negative in the formula (2), it becomes  $\frac{1}{p} - \frac{1}{p'} = \frac{2}{R}$ ; in this form it comprehends all cases of virtual images in concave mirrors.

In the case of convex mirrors, the image is always virtual (515);  $p'$  and  $R$  are of the same sign, since the image and the centre are on the same side of the mirror, while the object being on the opposite side,  $p$  is of the contrary sign; hence in the formula (2) we get

$$\frac{1}{p'} - \frac{1}{p} = \frac{2}{R} \quad . \quad . \quad . \quad . \quad . \quad (5)$$

as the formula for convex mirrors. It may also be found directly by the same geometrical considerations as those which have led to the formula (2) for concave mirrors.

It must be observed that the preceding formulæ are not rigorously true, inasmuch as they depend upon the hypothesis that the lines  $LM$  and  $LM$  (fig. 401) are equal to  $LA$  and  $AL$ ; although this is not true, the error diminishes without limit with the angle  $MCA$ : and when this angle does not exceed a few degrees, the error is so small that it may, in practice, be neglected.

518. **Calculation of the magnitude of images.**—By means of the above formulæ the magnitude of an image may be calculated, when the

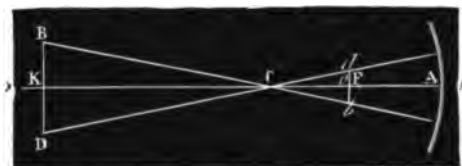

Fig. 402.

distance of the object, its magnitude, and the radius of the mirror are given. For if  $BD$  be the object (fig. 402),  $bd$  its image, and if the distance  $A$  and the radius  $AC$  be known,  $Ao$  can be calculated by means of formula (3) of article 516.  $Ao$  known,  $oC$  can be calculated. But as the triangles  $BCD$  and  $dCb$  are similar, their bases and heights are in the proportion  $bd : BD = Co : CK$ , or

$$\begin{aligned} & \text{Length of the image : length of the object} \\ & = \text{distance from image to centre : distance from the object to the centre.} \end{aligned}$$

519. **Spherical aberration. Caustics.**—In the foregoing theory of the foci and images of spherical mirrors, it has already been observed that the reflected rays only pass through a single point when the aperture of the mirror does not exceed 8 or 10 degrees (511). With a larger aperture the rays reflected near the edges meet the axis nearer the mirror than those that

are reflected at a small distance from the neighbourhood of the centre of the mirror. Hence arises a want of precision in these images, which is called *spherical aberration* by reflection, to distinguish it from the spherical aberration by refraction, which occurs in the case of lenses.

Every reflected ray cuts the one next to it (fig. 403), and their points of intersection form in space a curved surface, which is called the *caustic* by



Fig. 403.

*reflection*. The curve FM represents one of the branches of a section of this surface made by the plane of the paper. When the light of a candle is reflected from the inside of a cup or tumbler, a section of the caustic surface can be seen by partly filling the cup or tumbler with milk.

**520. Applications of mirrors. Heliostat.**—The applications of plane mirrors in domestic economy are well known. Mirrors are also frequently used in physical apparatus for sending light in a certain direction. The solar light can only be sent in a constant direction by making the mirror movable. It must have a motion which compensates for the continual change in the direction of the sun's rays produced by the apparent diurnal motion of the sun. This result is obtained by means of a clockwork motion, to which the mirror is fixed, and which causes it to follow the course of the sun. This apparatus is called the *heliostat*. We have already seen an application of this in the heliograph (509). The reflection of light is also used to measure the angles of crystals by means of the instruments known as *reflecting goniometers*.

Concave spherical mirrors are also often used. They are applied for magnifying *mirrors*, as in a shaving mirror. They have been employed for burning mirrors, and are still used in telescopes. They also serve as reflectors, for conveying light to great distances, by placing a luminous object in their principal focus. For this purpose, however, parabolic mirrors are preferable.

While the images of objects seen in concave or convex mirrors appear smaller or larger, but otherwise similar geometrically, this is not the case with *cylindrical* or with *conical* mirrors. Objects seen in such mirrors appear ludicrously distorted. From the laws of reflection the shape of such a distorted figure can be geometrically constructed. In like manner distorted images of objects can be constructed which seen in such mirrors appear in their normal proportions. They are called *anamorphoses*.

**521. Parabolic mirrors.**—*Parabolic mirrors* are concave mirrors, whose surface is generated by the revolution of the arc of a parabola, AM, about its axis, AX (fig. 404).

It has been already stated that in spherical mirrors the rays parallel to the axis converge only approximately to the principal focus, and reciprocally when a source of light is placed in the principal focus of these mirrors the reflected rays are not exactly parallel to the axis. Parabolic mirrors are free from this defect; they are more difficult to construct, but are far better for reflectors. It is a well-known property of a parabola that the right line FM, drawn from the focus F, to any point, M, of the curve, and the line ML, parallel to the axis AF, make equal angles with the tangent TT' at this point. Consequently, all rays

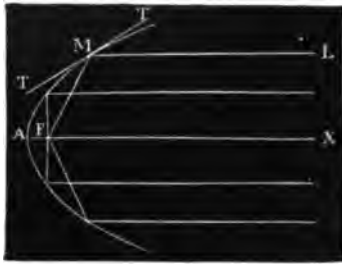

Fig. 404

parallel to the axis after reflection meet in the focus of the mirror F, and conversely, when a source of light is placed in the focus, the rays incident on the mirror are reflected exactly parallel to the axis. The light thus reflected tends to maintain its intensity even at a great distance, for it has been seen (494) that it is the divergence of the luminous rays which principally weakens the intensity of light.



Fig. 405.

two directions at once. This arrangement is used in lighting staircases and passages.

### CHAPTER III.

#### SINGLE REFRACTION. LENSES.

522. **Phenomenon of refraction.**—*Refraction* is the deflection or bending which luminous rays experience in passing obliquely from one medium to another; for instance, from air into water. We say obliquely, because if the incident ray is perpendicular to the surface separating the two media, it is not bent, and continues its course in a right line.

The *incident ray* being represented by SO (fig. 406), the *refracted ray* is

the direction OH which light takes in the second medium ; and of the angles SOA and HOB, which these rays form with the line AB, at right angles to the surface which separates the two media, the first is the *angle of incidence*, and the other the *angle of refraction*. According as the refracted ray approaches or deviates from the normal, the second medium is said to be more or less *refracting* or *refracting* than the first.



Fig. 406.

All the light which falls on a refracting surface does not completely pass into it ; one part is reflected and scattered (504), while another penetrates into the medium.

Mathematical analysis shows that the direction of refraction depends on the relative velocity of light in the two media. On the undulatory theory the more highly refracting medium is that in which the velocity of propagation is least.

In uncrystallised media, such as air, liquids, ordinary glass, the luminous ray is singly refracted ; but in certain crystallised bodies, such as Iceland spar, Selenite, etc., the incident ray gives rise to two refracted rays. The latter phenomenon is called *double refraction*, and will be discussed in another part of the book. We shall here deal exclusively with *single refraction*.

523. **Laws of single refraction.**—When a luminous ray is refracted in passing from one medium into another of a different refractive power, the following laws prevail :—

I. *Whatever the obliquity of the incident ray, the ratio which the sine of the incident angle bears to the sine of the angle of refraction is constant for the same two media, but varies with different media.*

II. *The incident and the refracted ray are in the same plane which is perpendicular to the surface separating the two media.*

These have been known as Descartes' laws ; they are, however, really due to Willibrod Snell who discovered them in 1620 ; they are demonstrated by the same apparatus as that used for the laws of reflection (497). The plane mirror in the centre of the graduated circle is replaced by a semi-cylindrical glass vessel, filled with water to such a height that its level is exactly the height of the centre (fig. 407). If the mirror, M, be then so inclined that a reflected ray, MO, is directed towards the centre, it is refracted on passing into the water, but it passes out without refraction because then its direction is at right angles to the curved sides of the vessel.

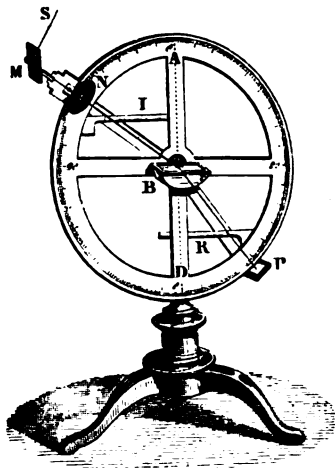

Fig. 407.

In order to observe the course of the refracted ray, it is received on a screen, P, which is moved until the image of the aperture in the screen N is formed



in its centre. In all positions of the screens N and P, the sines of the angles of incidence and refraction are measured by means of two graduated rules, movable so as to be always horizontal, and hence perpendicular to the diameter AD.

On reading off the lengths of the sines of the angles MOA and DOP in the scales I and R, the numbers are found to vary with the position of the screens, but their ratio is constant; that is, if the sine of incidence becomes twice or three times as large, the sine of refraction increases in the same ratio, which demonstrates the first law. The second law follows from the arrangement of the apparatus, for the plane of the graduated limb is perpendicular to the surface of the liquid in the semi-cylindrical vessel.

524. **Index of refraction.**—The ratio between the sines of the incident and refracted angle is called *index of refraction* or *refractive index*. It varies with the media; for example, from air to water it is  $\frac{4}{3}$ , and from air to glass it is  $\frac{3}{2}$ .

If the media is considered in an inverse order—that is, if light passes from water to air, or from glass to air—it follows the same course, but in a contrary direction, PO becoming the incident and OM the refracted ray. Consequently the index of refraction is reversed; from water to air it is then  $\frac{3}{4}$ , and from glass to air  $\frac{2}{3}$ .

525. **Effects produced by refraction.**—In consequence of refraction, bodies immersed in a medium more highly refracting than air appear nearer the surface of this medium, but they appear to be more distant if immersed in a less refracting medium. Let L (fig. 408) be an object immersed in a

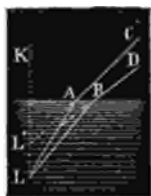

Fig. 408.

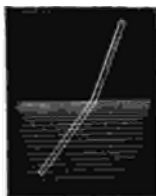

Fig. 409.

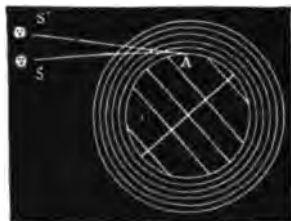

Fig. 410.

mass of water. In passing thence into air, the rays LA, LB . . . diverge from the normal to the point of incidence, and take the direction AC, BD . . . , the prolongations of which intersect approximately in the point L', placed on the perpendicular L'K. The eye receiving these rays sees the object L at L'. The greater the obliquity of the rays LA, LB . . . the higher the object appears.

It is for the same reason that a stick plunged obliquely into water appears bent (fig. 409), the immersed part appearing raised.

Owing to an effect of refraction, stars are visible to us even when they are below the horizon. For as the layers of the atmosphere are denser in proportion as they are nearer the earth, and as the refractive power of a gas increases with its density (536), it follows that on entering the atmosphere the luminous rays become bent, as seen in the fig. 410, describing a curve before

reaching the eye, so that we can see the star at  $S'$  along the tangent of this curve instead of at  $S$ . In our climate the atmospheric refraction does not raise the stars when on the horizon more than half a degree. Another experimental illustration of the effect of refraction is the following :—A coin is placed in an empty porcelain basin, and the position of the eye is so adjusted that it is just not visible. If now, the position of the eye remaining unaltered, water be poured into the basin the coin becomes visible. ) A consideration of fig. 408 will suggest the explanation of this phenomenon. )

526. **Total reflection. Critical angle.**—When a luminous ray passes from one medium into another which is less refracting, as from water into air, it has been seen that the angle of incidence is less than the angle of refraction. Hence, when light is propagated in a mass of water from  $S$  to  $O$  (fig. 411), there is always a value of the angle of incidence  $SOB$ , such that

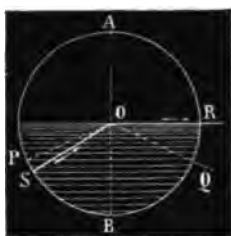

Fig. 411.



Fig. 412.

the angle of refraction,  $AOR$ , is a right angle, in which case the refracted ray emerges parallel to the surface of the water.

This angle,  $SOB$ , is called the *critical angle*, since for any greater angle,  $POB$ , the incident ray cannot emerge, but undergoes an internal reflection, which is called *total reflection*, because the incident light is entirely reflected. From water to air the critical angle is  $48^{\circ} 35'$ ; from glass to air,  $41^{\circ} 48'$ .

The occurrence of this internal reflection may be observed by the following experiment. An object,  $A$ , is placed before a glass vessel filled with water (fig. 412); the surface of the liquid is then looked at as shown in the figure, and an image at the object  $A$  is seen at  $a$ , formed by the rays reflected at  $m$ , in the ordinary manner of a mirror.

Similar effects of the total reflection of the images of objects contained in aquaria are frequently observed, and add much to the interest of their appearance.

In total reflection there is no loss of light from absorption or transmission, and accordingly it produces the greatest brilliancy. If a test tube half full of water be placed in water, the empty part shines as brilliantly as pure mercury. Bubbles again in water glisten like pearls, and cracks in transparent bodies like strips of silver, for the oblique rays are totally reflected. The lustre of transparent bodies bounded by plane surfaces, such as the lustre of chandeliers, arises mainly from total reflection. This lustre is more frequent and more brilliant the smaller the limiting angle; the lustre of diamond therefore is the most brilliant.

527. **Mirage.**—The *mirage* is an optical illusion by which inverted images of distant objects are seen as if below the ground or in the atmosphere. This phenomenon is of most frequent occurrence in hot climates, and more especially on the sandy plains of Egypt. The ground there has often the

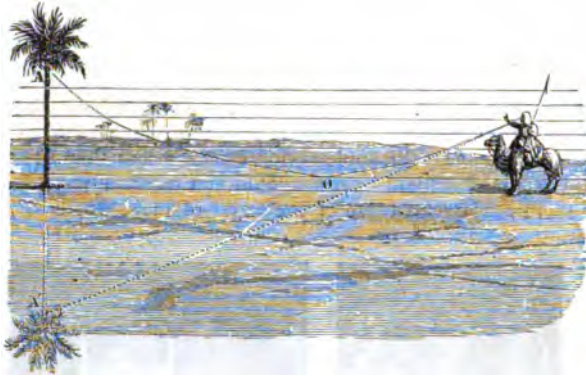

Fig. 413.

aspect of a tranquil lake, on which are reflected trees and the surrounding villages. Monge, who accompanied Napoleon's expedition to Egypt, was the first to give an explanation of the phenomenon.

It is a phenomenon of refraction, which results from the unequal density of the different layers of the air when they are expanded by contact with the heated soil. The least dense layers are then the lowest, and a luminous ray from an elevated object, A (fig. 413), traverses layers which are gradually less refracting; for, as will be shown presently (536), the refracting power of a gas diminishes with lessened density. The angle of incidence accordingly increases from one layer to the other, and ultimately reaches the critical angle, beyond which internal reflection succeeds to refraction (526). The ray then rises, as seen in the figure, and undergoes a series of successive refractions, but in the direction contrary to the first, for it now passes through layers which are gradually more refracting. The luminous ray then reaches the eye with the same direction as if it had proceeded from a point below the ground, and hence it gives an inverted image of the object, just as if it had been reflected at the point O, from the surface of a tranquil lake.

The effect of the mirage may be illustrated artificially, as Dr. Wollaston showed, by looking along the side of a red-hot poker at a word or object ten or twelve feet distant. At a distance less than three-eighths of an inch from the line of the poker, an inverted image was seen, and within and without that an erect image. A more convenient arrangement than a red-hot poker is a flat box closed at the top and filled with red-hot charcoal.

Mariners sometimes see images in the air of the shores or of distant vessels. This is due to the same cause as the mirage, but in a contrary direction, only occurring when the temperature of the air is above that of the sea, for then the inferior layers of the atmosphere are denser, owing to their contact with the surface of the water. Scoresby observed several such cases in the Polar Seas.

TRANSMISSION OF LIGHT THROUGH TRANSPARENT MEDIA.

528. **Media with parallel faces.**—When light traverses a medium with parallel faces the *emergent* rays are parallel to the incident rays.

Let MN (fig. 414) be a glass plate with parallel faces, let SA be the incident and DB the emergent ray,  $i$  and  $r$  the angles of incidence and of refraction at the entrance of the ray, and, lastly,  $i'$  and  $r'$  the same angles at its emergence. At A the light undergoes a first refraction, the index of which is  $\frac{\sin i}{\sin r}$ .

(523). At D it is refracted a second time, and the index is then  $\frac{\sin i'}{\sin r'}$ . But we have seen that the index of refraction of glass to air is the reciprocal of its refraction from air to glass; hence

$$\frac{\sin i'}{\sin r'} = \frac{\sin r}{\sin i}$$

But as the two normals AG and DE are parallel, the angles  $r$  and  $i'$  are equal, as being alternate interior angles. As the numerators in the above equation are equal, the denominators must be also equal; the angles  $r'$  and  $i$  are therefore equal, and hence DB is parallel to SA.

529. **Prism.**—In optics a *prism* is any transparent medium comprised between two plane faces inclined to each other. The intersection of these two faces is the *edge* of the prism, and their inclination is its refracting angle. Every section perpendicular to the edge is called a *principal section*.

The prisms used for experiments are generally right triangular prisms of glass, as shown in fig. 415, and their principal section is a triangle (fig.

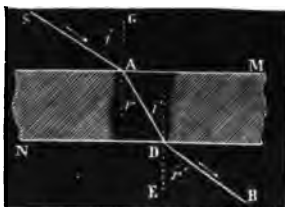

Fig. 414.



Fig. 415.

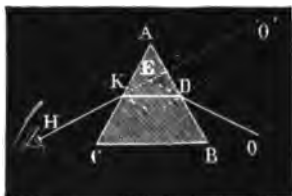

Fig. 416.

416). In this section the point A is called the *summit* of the prism, and the right line BC is called the *base*; these expressions have reference to the triangle ABC, and not to the prism.

530. **Path of rays in prisms. Angle of deviation.**—When the laws of refraction are known, the path of the rays in a prism is readily determined. Let O be a luminous point (fig. 416) in the same plane as the principal section ABC of a prism, and let OD be an incident ray. This ray is refracted at D, and approaches the normal, because it passes into a more highly re-

fracting medium. At K it experiences a second refraction, but it then deviates from the normal, for it passes into air, which is less refractive than glass. The light is thus refracted twice in the same direction, so that *the ray is deflected towards the base*, and consequently the eye which receives the emergent ray KH sees the object O at O'; that is, *objects seen through a prism appear deflected towards its summit*. The angle OEO', which the incident and emergent rays form with each other, expresses the deviation of light caused by the prism, and is called *the angle of deviation*.

Besides this, objects seen through a prism appear in all the colours of the rainbow; this phenomenon will be described under the name of *dispersion*.

This angle increases with the refractive index of the material of the prism, and also with its refracting angle. It also varies with the angle under which

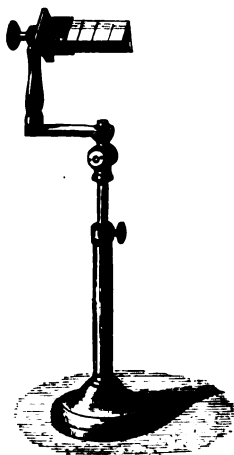

Fig. 417.



Fig. 418.

the luminous ray enters the prism. The angle of deviation increases up to a certain limit, which is determined by calculation, knowing the angles of incidence of the ray, and the refracting angle of the prism.

That the angle of deviation increases with the refractive index may be shown by means of the *polyprism*. This name is given to a prism formed of several prisms of the same angle connected at their ends (fig. 417). These prisms are made of substances unequally refringent, such as flint glass, rock crystal, or crown glass. If any object—a line, for instance—be looked at through the polyprism, its different parts are seen at unequal heights. The highest portion is that seen through the flint glass, the refractive index of which is greatest; then the rock crystal; and so on in the order of the decreasing refractive indices.

The *prism with variable angle* (fig. 418), is used for showing that the angle of deviation increases with the refracting angle of the prism. It consists of two parallel brass plates, B and C, fixed on a support. Between these are two glass plates moving, on a hinge, with some friction against the plates,

so as to close it. When water is poured into the vessel the angle may be varied at will. If a ray of light, S, be allowed to fall upon one of them, by inclining the other more, the angle of the prism increases, and the deviation of the ray is seen to increase.

531. **Application of right-angled prisms in reflectors.**—Prisms whose principal section is an isosceles right-angled triangle afford an important application of total reflection (526). For let ABC (fig. 419) be the principal section of such a prism, O a luminous point, and OH a ray of right angles to the face BC. This ray enters the glass without being refracted, and makes with the face AB an angle equal to B, that is to 45 degrees, and therefore greater than the limiting angle of glass, which is  $41^{\circ} 48'$  (526). The ray OH undergoes, therefore, at H total reflection, which imparts to it a direction HI perpendicular to the second face AC. Thus the hypotenuse surface of this prism produces the effect of the most perfect plane mirror, and an eye placed at I sees O' the image of the point O. This property of right-angled prisms is frequently used in optical instruments.

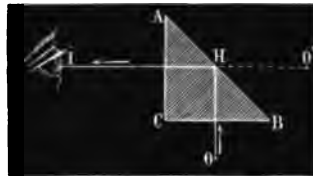

Fig. 419.

532. **Conditions of emergence in prisms.**—In order that any luminous rays refracted at the first face of a prism may emerge from the second, it is necessary that the refractive angle of the prism be less than twice the critical angle of the substance of which the prism is composed. For if LI (fig. 420) be the ray incident on the first face, IE the refracted ray, PI and PE the normals, the ray IE can only emerge from the second face when the incident angle IEP is less than the critical angle (526). But as the incident angle LIN increases, the angle EIP also increases, while IEP diminishes. Hence, according as the direction of the ray LI tends to become parallel with the face AB, does this ray tend to emerge at the second face.

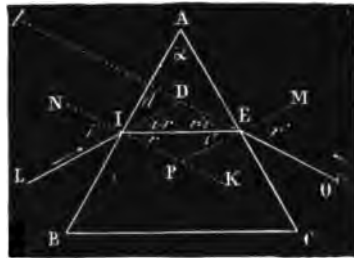

Fig. 420.

Let LI be now parallel to AB, the angle  $r$  is then equal to the critical angle  $l$  of the prism because it has its maximum value. Further, the angle EPK, the exterior angle of the triangle IPE, is equal to  $r + i'$ ; but the angles EPK and A are equal, because their sides are perpendicular, and therefore  $A = r + i'$ ; therefore also  $A = l + i'$ , for in this case  $r = l$ . Hence, if  $A = 2l$  or is  $> 2l$ , we shall have  $i' = l$  or  $> l$ , and therefore the ray would not emerge at the second face, but would undergo internal reflection, and would emerge at a third face, BC. This would be much more the case with rays whose incident angle is less than BIN, because we have already seen that  $i'$  continually increases. Thus in the case in which the refracting angle of a prism is equal to  $2l$  or is greater, no luminous ray could pass through the faces of the refracting angle.



minimum of deviation are known. The index of refraction  $n$  is the ratio of the sines of the angles of incidence and refraction; hence  $n = \frac{\sin i}{\sin r}$ ; replacing  $i$  and  $r$  from their values in the above equations (1) and (2) we get

$$n = \frac{\left(\frac{A+d}{2}\right)}{\sin \frac{A}{2}} \dots \dots \dots (3)$$

534. **Measurement of the index of refraction in solids.**—By means of the preceding formula (3) the refractive index of a solid may be calculated when the angles  $A$  and  $d$  are known.

In order to determine the angle  $A$ , the substance is cut in the form of a triangular prism, and the angle measured by means of a goniometer (520).

The angle  $d$  is measured in the following manner: a ray,  $LI$ , emitted from a distant object (fig. 422), is received on the prism, which is turned

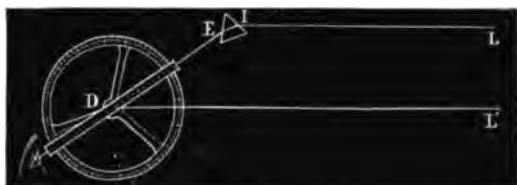

Fig. 422.

in order to obtain the minimum deviation  $EDL'$ . By means of a telescope with a graduated circle, the angle  $EDL'$  is read off, which the refracted ray  $DE$  makes with the ray  $DL'$ , coming directly from the object; now this is the angle of minimum deviation, assuming that the object is so distant that the two rays  $LI$  and  $L'D$  are approximately parallel. These values then only need to be substituted in the equation (3) to give the value of  $n$ .

535. **Measurement of the index of refraction of liquids.**—Biot applied Newton's method to determining the refractive index of liquids. For this purpose a cylindrical cavity  $O$ , of about 0.75 in. in diameter, is perforated in a glass prism,  $PQ$  (fig. 423), from the incident face to the face of emergence. This cavity is closed by two plates of thin glass which are cemented on the sides of this prism. Liquids are introduced through a small stoppered aperture,  $B$ . The refracting angle and the minimum deviation of the liquid prism in the cavity  $O$  having been determined, their values are introduced into the formula (3), which gives the index.

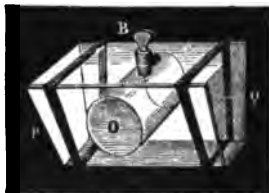

Fig. 423.

536. **Measurement of the index of refraction of gases.**—A method for this purpose founded on that of Newton was devised by Biot and Arago. The apparatus which they used consists of a glass tube (fig. 424),



bevelled at its two ends, and closed by glass plates, which are at an angle of  $143^\circ$ . This tube is connected with a bell-jar, H, in which there is a siphon barometer, and with a stopcock by means of which the apparatus can be exhausted, and different gases introduced. After having exhausted the tube AB, a ray of light, SA, is transmitted, which is bent away from the normal through an angle  $r-i$  at the first incidence, and towards it through an angle  $i'-r'$  at the second. These two deviations being added, the total deviation  $d$  is  $r-i+i'-r'$ . In the case of a minimum deviation,  $i=r'$  and  $r=i'$ , whence  $d=A-2i$ , since  $r+i=A$  (532). The index from vacuum to air, which is evidently  $\frac{\sin r}{\sin i}$ , has therefore the value

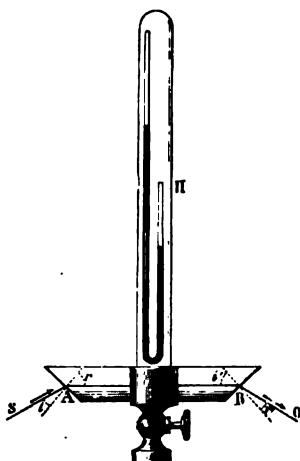

Fig. 424.

$$\sin \left( \frac{A-d}{2} \right) \cdot \cdot \cdot \quad (4)$$

Hence, in order to deduce the refractive index from vacuum into air, which is the *absolute index* or *principal index*, it is simply necessary to know the refracting angle  $A$ , and the angle of minimum deviation  $d$ .

To obtain the absolute index of any other gas, after having produced a vacuum, this gas is introduced; the angles  $A$  and  $d$  having been measured, the above formula gives the index of refraction from gas to air. Dividing the index of refraction from vacuum to air by the index of refraction from the gas to air, we obtain the index of refraction from vacuum to the gas, that is, its absolute index.

By means of this apparatus Biot and Arago have found that the refractive indices of gases are very small as compared with those of solids and liquids, and that for the same gas the *refractive power is proportional to the density*; meaning by the refractive action of a substance the square of its refractive index less unity; that is,  $n^2 - 1$ . The refractive action divided by the density, or

$$\frac{n^2 - 1}{d},$$

is called the *absolute refractive power*.

Table of the absolute indices of refraction.

Diamond . . . . .	2'47 to 2'75	Iceland spar, ordinary ray . . . . .	1'654
Phosphorus . . . . .	2'224	Iceland spar, extraordinary ray . . . . .	1'483
Sulphur . . . . .	2'115	Flint glass . . . . .	1'575
Ruby . . . . .	1'779	Rock salt . . . . .	1'550
Bisulphide of carbon . . . . .	1'678		

Table of the absolute indices of refraction—continued.

Rock crystal . . . . .	1·548	Ether . . . . .	1·358
Plate glass. St. Gobin . . . . .	1·543	Crystalline lens . . . . .	1·384
Crown glass . . . . .	1·600	Vitreous " . . . . .	1·339
Turpentine . . . . .	1·470	Aqueous " . . . . .	1·357
Alcohol . . . . .	1·374	Water . . . . .	1·336
Albumen . . . . .	1·360	Ice . . . . .	1·310

Refractive indices of gases.

Vacuum . . . . .	1·000000	Carbonic acid . . . . .	1·000449
Hydrogen . . . . .	1·000138	Hydrochloric acid . . . . .	1·000449
Oxygen . . . . .	1·000272	Nitrous oxide . . . . .	1·000503
Air . . . . .	1·000294	Sulphurous acid . . . . .	1·000665
Nitrogen . . . . .	1·000300	Olefiant gas . . . . .	1·000678
Ammonia . . . . .	1·000385	Chlorine . . . . .	1·000772

LENSES. THEIR EFFECTS.

537. **Different kinds of lenses.**—Lenses are transparent media, which, from the curvature of their surfaces, have the property of causing the luminous rays which traverse them either to converge or to diverge. According to their curvature they are either *spherical*, *cylindrical*, *elliptical*, or *parabolic*. Those used in optics are always spherical. They are commonly made either of *crown glass*, which is free from lead, or of *flint glass*, which contains lead, and is more refractive than crown glass.

The combination of spherical surfaces, either with each other or with plane surfaces, gives rise to six kinds of lenses, sections of which are repre-

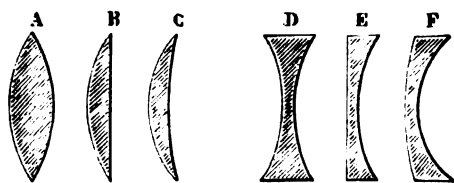

Fig. 425.

sented in fig. 425 ; four are formed by two spherical surfaces, and two by a plane and a spherical surface.

A is a *double convex*, B is a *plano-convex*, C is a *converging concavo-convex*, D is *double concave*, E is a *plano-concave*, and F is a *diverging convexo-concave*. The lenses C and F are also called *meniscus* lenses, from their resemblance to the crescent-shaped moon.

The first three, which are thicker at the centre than at the borders, are *converging* ; the others, which are thinner in the centre, are *diverging*. In the first group, the double convex lens only need be considered, and in the second the double concave, as the properties of each of these lenses apply to all those of the same group.

In lenses whose two surfaces are spherical, the centres for these surfaces are called *centres of curvature*, and the right line which passes through these two centres is the *principal axis*. In a plano-concave or plano-convex lens, the principal axis is the perpendicular let fall from the centre of the spherical face on the plane face.

In order to compare the path of a luminous ray in a lens with that in a prism, the same hypothesis is made as for curved mirrors (511), that is, the surfaces of these lenses are supposed to be formed of an infinity of small plane surfaces or elements; the *normal* at any point is then the perpendicular to the plane of the corresponding element. It is a geometrical principle, that all the normals to the same spherical surface pass through its centre. On the above hypothesis we can always conceive two plane surfaces at the points of incidence and convergence, which are inclined to each other, and thus produce the effect of a prism. Pursuing this comparison, the three lenses A, B, and C may be compared to a succession of prisms having their summits outwards, and the lenses D, E, and F to a series having their summits inwards; from this we see that the first ought to condense the rays, and the latter to disperse them, for we have already seen that when a luminous ray traverses a prism it is deflected towards the base (530).

**538. Foci in double convex lenses.**—The focus of a lens is the point where the refracted rays, or their prolongations, meet. Double convex lenses have the same kind of foci as concave mirrors; that is, real foci and virtual foci.

*Real foci.* We shall first consider the case in which the luminous rays which fall on the lens are parallel to its principal axis, as shown in fig. 426. In this case, any incident ray, LB, in approaching the normal of the

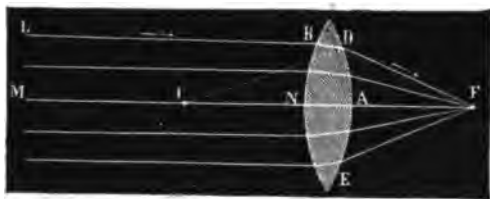

Fig. 426.

point of incidence B, and in diverging from it at the point of emergence D, is twice refracted towards the axis, which it cuts at F. As all rays parallel to the axis are refracted in the same manner, it can be shown by calculation that they all pass very nearly through the point F, so long as the arc DE does not exceed  $10^\circ$  to  $12^\circ$ . This point is called the *principal focus*, and the distance FA is the *principal focal distance*. It is constant in the same lens, but varies with the radii of curvature and the index of refraction. In ordinary lenses, which are of crown glass, and in which the radii of the two surfaces are nearly equal, the principal focus coincides very closely with the centre of curvature.

We shall now consider the case in which the luminous object is outside

the principal focus, but so near that all incident rays form a divergent pencil, as shown in fig. 427. The luminous point being at L, by comparing the path of a diverging ray, LB, with that of a ray, SB, parallel to the axis, the former is found to make with the normal an angle,  $LBn$ , greater than the angle  $SBn$ ; consequently, after traversing the lens, the ray cuts the axis at a point,  $l$ , which is more distant than the principal focus F. As all rays from

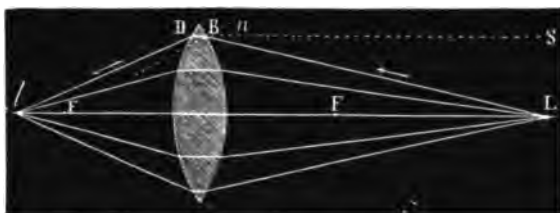

Fig. 427.

the point L intersect approximately in the same point  $l$ , this latter is the *conjugate focus* of the point L; this term has the same meaning here as in the cases of mirrors, and expresses the relation existing between the two points L and  $l$ , which is of such a nature that, if the luminous point is moved to  $l$ , the focus passes to L.

According as the object comes nearer the lens, the convergence of the emergent rays decreases, and the focus  $l$  becomes more distant; when the object L coincides with the principal focus, the emergent rays on the other side are parallel to the axis, and there is no focus, or, what is the same thing, it is infinitely distant. As the refracted rays are parallel in this case, the intensity of light only decreases slowly, and a simple lamp can illuminate great distances. It is merely necessary to place it in the focus of a double convex lens, as shown in fig. 428.

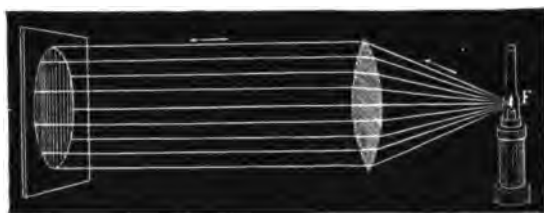

Fig. 428.

*Virtual foci.* A double convex lens has a virtual focus when the luminous object is placed between the lens and the principal focus, as shown in fig. 429. In this case the incident rays make with the normal greater angles than those made by the rays FI from the principal focus; hence, when the former rays emerge, they move farther from the axis than the latter, and form a diverging pencil, HK, GM. These rays cannot produce a real focus, but

their prolongations intersect in some point,  $l$ , on the axis, and this point is the virtual focus of the point  $L$  (500).



Fig. 429.

539. **Foci in double concave lenses.**—In double concave lenses there are only virtual foci, whatever the distance of the object. Let  $SS'$  be any pencil of rays parallel to the axis (fig. 430), any ray,  $SI$ , is refracted at the point of incidence,  $I$ , and approaches the normal  $CI$ . At the point of emergence it is also refracted, but diverges from the normal  $GC'$ , so that it is twice refracted in a direction which moves it from the axis  $CC'$ . As the

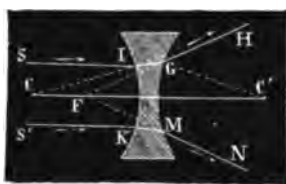

Fig. 430.



Fig. 431.

same thing takes place for every other ray,  $S'KMN$ , it follows that the rays, after traversing the lens, form a diverging pencil,  $GHMN$ . Hence there is no real focus, but the prolongations of these rays cut one another in a point,  $F$ , which is the principal virtual focus.

In the case in which the rays proceed from a point,  $L$  (fig. 431), on the axis, it is found by the same construction that a virtual focus is formed at  $l$ , which is between the principal focus and the lens.

540. **Experimental determination of the principal focus of lenses.**—To determine the principal focus of a double convex lens, it may be exposed to the sun's rays so that they are parallel to its axis. The emergent pencil being received on a ground-glass screen, the point to which the rays converge is readily seen; it is the principal focus.

With a double concave lens, the face  $ab$  (fig. 432) is covered with an opaque substance, such as lampblack, two small apertures,  $a$  and  $b$ , being left in the same principal section, and at an equal distance from the axis; a pencil of solar light is then received on the other face, and the screen  $P$ , which receives the emergent rays, is moved nearer to or farther from the lens, until  $A$  and  $B$ , the spots of light from the small apertures  $a$  and  $b$ , are distant from each other by twice  $ab$ . The distance  $DI$  is then equal to the focal distance  $FD$ , because the triangles  $Fab$  and  $FAB$  are similar.

541. **Optical centre, secondary axis.**—In every lens there is a point called the *optical centre*, which is situated on the axis, and which has the

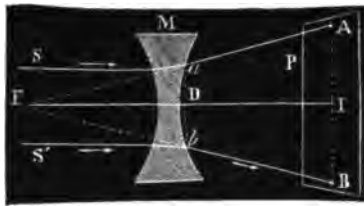

Fig. 432.

property that any luminous ray passing through it experiences no angular deviation; that is, that the emergent ray is parallel to the incident ray. The existence of this point may be demonstrated in the following manner: Let two parallel radii of curvature, CA and C'A' (fig. 433) be drawn to the

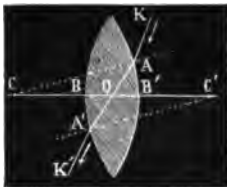

Fig. 433.

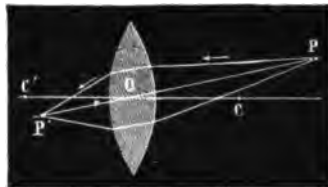

Fig. 434.

two surfaces of a double convex lens. Since the two plane elements of the lens A and A' are parallel, as being perpendicular to two parallel right lines, it will be granted that the refracted ray KA, A'K' is propagated in a medium with parallel faces. Hence, a ray KA which reaches A at such an inclination that after refraction it takes the direction AA' will emerge parallel to its first direction (528); the point O, at which the right line cuts the axis, is therefore the optical centre. The position of this point may be determined for the case in which the curvature of the two faces is the same, which is the usual condition, by observing that the triangles COA and C'OA' are equal, and therefore that  $OC = OC'$ , which gives the point O. If the curvatures are unequal, the triangle COA and C'OA' are similar, and either CO or C'O may be found, and therefore also the point O.

In double concave or concavo-convex lenses the optical centre may be determined by the same construction. In lenses with a plane face this point is at the intersection of the axis by the curved face.

Every right line, PP' (fig. 434), which passes through the optical centre without passing through the centres of curvature, is a *secondary axis*. From this property of the optical centre, every secondary axis represents a luminous rectilinear ray passing through this point, for from the slight thickness of the lens, it may be assumed that rays passing through the optical centre are in a right line; that is, that the small deviation may be neglected which rays experience in traversing a medium with parallel faces (fig. 414).

So long as the secondary axes only make a small angle with the principal axis, all that has hitherto been said about the principal axis is applicable to them; that is, that rays emitted from a point,  $P$  (fig. 434), on the secondary axis  $PP'$ , nearly converge to a certain point of the axis,  $P'$ , and according as the distance from the point  $P$  to the lens is greater or less than the principal focal distance, the focus thus formed will be conjugate or virtual. This principle is the foundation of what follows as to the formation of images.

542. **Formation of images in double convex lenses.**—In lenses as well as in mirrors the image of an object is the collection of the foci of its several points; hence the images furnished by lenses are real or virtual in the same case as the foci, and their construction resolves itself into determining the position of a series of points, as was the case with mirrors (514).

i. *Real image.* Let  $AB$  (fig. 435) be placed beyond the principal focus. If a secondary axis,  $Aa$ , be drawn from the outside point  $A$ , any ray,  $AC$ , from

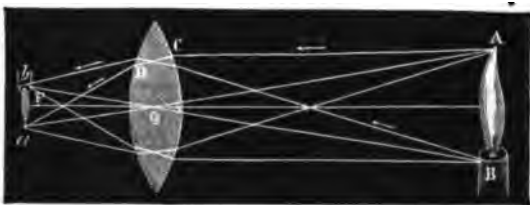

Fig. 435.

this point, will be twice refracted at  $C$  and  $D$ , and both times in the same direction, approaching the secondary axis, which it cuts at  $a$ . From what has been said in the last paragraph, the other rays from the point  $A$  will intersect in the point  $a$ , which is accordingly the conjugate focus of the point  $A$ . If the secondary axis be drawn from the point  $B$ , it will be seen, in like manner, that the rays from this point intersect in the point  $b$ , and as the points between  $A$  and  $B$  have their foci between  $a$  and  $b$ , a *real* but *inverted* image of  $AB$  will be formed at  $ab$ .

In order to see this image, it may be received on a white screen, on which it will be depicted, or the eye may be placed in the path of the rays emerging from it.

Conversely, if  $ab$  were the luminous or illuminated object which emitted rays, its image would be formed at  $AB$ . Two consequences important for the theory of optical instruments follow from this: that 1st, *If an object, even a very large one, is at a sufficient distance from a double convex lens, the real and inverted image which is obtained of it is very small, it is near the principal focus, but somewhat farther from the lens than this is*; 2nd, *If a very small object be placed near the principal focus, but a little in front of it, the image which is formed is at a great distance, it is much larger, and that in proportion as the object is near the principal focus.* In all cases the object and the image have the same proportion as their distances from the lens.

These two principles are experimentally confirmed by receiving on a screen the image of a lighted candle, placed successively at various distances from a double convex lens.

ii. *Virtual image.* There is another case in which the object AB (fig. 436) is placed between the lens and its principal focus. If a secondary axis,  $Oa$ , be drawn from the point A, every ray, AC, after having been twice refracted on emerging, diverges from this axis, since the point A is at a less distance

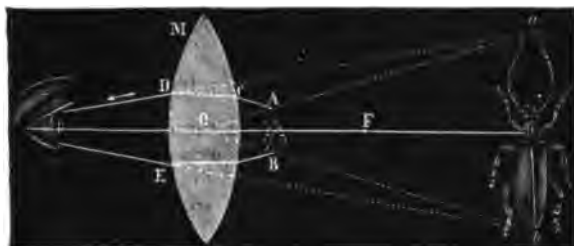

Fig. 436.

than the principal focal distance (538). This ray, continued in an opposite direction, will cut the axis  $Oa$  in the point  $a$ , which is the virtual focus of the point A. Tracing the secondary axis of the point B, it will be found, in the same manner, that the virtual focus of this point is formed at  $b$ . There is, therefore, an image of AB, at  $ab$ . *This is a virtual image, it is erect, and larger than the object.*

The magnifying power is greater in proportion as the lens is more convex, and the object nearer the principal focus. We shall presently show how the magnifying power may be calculated by means of the formulæ relating to lenses (545). Double convex lenses used in this manner as magnifying glasses, are called *simple microscopes*.

543. **Formation of images in double concave lenses.**—Double concave lenses, like convex mirrors, only give virtual images, whatever the distance of the object.

Let AB (fig. 437) be an object placed in front of such a lens. If the secondary axis AO be drawn from the point A, all rays, AC, AI, from this point are twice refracted in the same direction, diverging from the axis AO; so that the eye, receiving the emergent rays DE and GH, supposes them to proceed from the point where their prolongations cut the secondary axis AO in the point  $a$ . In like manner, drawing a secondary axis from the point B, the rays from this point form a pencil of divergent rays, the directions of which, prolonged, intersect in  $b$ . Hence the eye sees at  $ab$  a virtual image of AB, *which is always erect, and smaller than the object.*

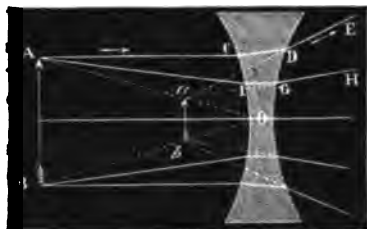

Fig. 437.

544. **Spherical aberration. Caustics.**—In the theory of the foci, and of the images formed by different kinds of spherical lenses, it has been hitherto assumed, that the rays emitted from a single point intersect also after refraction in a single point. This is virtually the case with a lens



whose *aperture*—that is, the angle obtained by joining the edges to the principal focus—does not exceed  $10^\circ$  or  $12^\circ$ .

Where, however, the aperture is larger, the rays which traverse the lens near the edge are refracted to a point G nearer the lens than the point F, which is the focus of the rays which pass near the axis. The phenomenon thus produced is named *spherical aberration by refraction* (519); it is analogous to the spherical aberration produced by reflection. The luminous surfaces formed by the intersection of the refracted rays are termed *caustics by refraction*.

Spherical aberration is prejudicial to the sharpness and definition of an image. If a ground glass screen be placed exactly in the focus of a lens, the image of an object will be sharply defined in the centre, but indistinct at the edges; and, *vice versa*, if the image is sharp at the edges, it will be indistinct in the centre. This defect is very objectionable, more especially in lenses used for photography. It is partially obviated by placing before the lenses diaphragms, provided with a central aperture, called *stops*, which admit the rays passing near the centre, but cut off those which pass near the edges. The image thereby becomes sharper and more distinct, though the illumination is less.

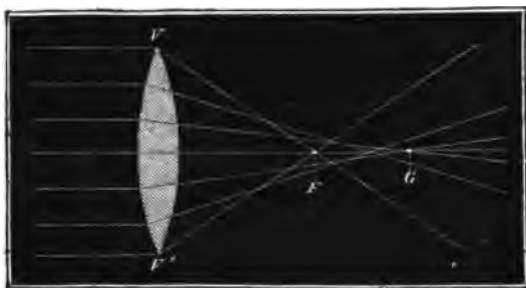

Fig. 438.

If between the light and an ordinary double convex lens a screen be held which quite covers the lens, but has two concentric series of holes, two images are obtained and may be received on a sheet of paper. By closing one or the other series of holes by a flat paper ring, it can be easily ascertained which image arises from the central and which from the marginal rays. When the paper is at a small distance the marginal rays produce the image in a point, and the central ones in a ring; the former are converged to a point and the latter not. At a somewhat greater distance the marginal rays produce a ring and the central ones a point. It is thus shown that the focus of the marginal rays is nearer the lens than that of the central rays.

Mathematical investigation shows that convex lenses, whose radii of curvature stand in the ratio expressed by the formula

$$\frac{r}{r_1} = \frac{4 - 2n^2 + n}{2n^2 + 2n}$$

are free from spherical aberration; in this formula  $r$  is the radius of curva-

ture of the foci turned to the parallel rays, and  $r_1$  that of the other face, while  $n$  is the refractive index. Spherical aberration is also destroyed by combining different lenses of suitable curvature.

Lenses which are free from spherical aberration are called *aplanatic*.

545. **Formulae relating to lenses.**—In all lenses, the relations between the distances of the image and object, the radii of curvature, and the refrac-



Fig. 439.

tive index, may be expressed by a formula. In the case of a double convex lens, let P be a luminous point, situate on the axis (fig. 439), let PI be an incident ray, IE its direction within the lens, EP' the emergent ray, so that P' is the conjugate focus of P. Further, let C'I and CE be the normals to the points of incidence and emergence, and IPA be put equal to  $a$ , EP'A' =  $\beta$ , ECA' =  $\gamma$ , IC'A =  $\delta$ , NIP =  $i$ , EIO =  $r$ , IEO =  $i'$ , N'EP' =  $r'$ .

Because the angle  $i$  is the exterior angle of the triangle PIC', and the angle  $r'$  the exterior angle of the triangle CEP', therefore,  $i = a + \delta$ , and  $r' = \gamma + \beta$ , whence

$$i + r' = a + \beta + \gamma + \delta \quad (1)$$

But at the point I,  $\sin i = n \sin r$ , and at the point E,  $\sin r' = n \sin i'$  (524),  $n$  being the refractive index of the lens. Now if the arc AI is only a small number of degrees, these sines may be considered as proportional to the angles  $i$ ,  $r$ ,  $i'$ , and  $r'$ , whence in the above formula, we may replace the sines by their angles, which gives  $i = nr$  and  $r' = ni'$ , from which  $i + r' = n(r + i')$ . Further, because the two triangles IOE and COC' have a common equal angle O, therefore  $r + i' = \gamma + \delta$ , from which  $i + r' = n(\gamma + \delta)$ . Introducing this value into the equation (1) we obtain

$$n(\gamma + \delta) = a + \beta + \gamma + \delta, \text{ from which } (n - 1)(\gamma + \delta) = a + \beta. \quad (2)$$

Let CA' be denoted by R, C'A by R', PA by  $p$ , and P'A' by  $p'$ . Then with centre P and radius PA describe the arc Ad, and with centre P' and radius P'A' describe the arc An. Now when an angle at the centre of a circle subtends a certain arc of the circumference, the quotient of the arc divided by the radius measures the angle; consequently,

$$a = \frac{Ad}{PA} \text{ or } \frac{Ad}{p}, \beta = \frac{A'n}{p'}, \gamma = \frac{A'E}{R}, \text{ and } \delta = \frac{AI}{R'}$$

Therefore by substitution in (2)

$$(n - 1) \left( \frac{A'E}{R} + \frac{AI}{R'} \right) = \frac{Ad}{p} + \frac{A'n}{p'}$$

Now since the thickness of the lens is very small, the angles are also small, and  $Ad$ ,  $AI$ ,  $A'E$ ,  $A'n$  differ but little from coincident straight lines, and are therefore virtually equal. Hence the above equation becomes

$$(n-1) \left( \frac{1}{R} + \frac{1}{R'} \right) = \frac{1}{p} + \frac{1}{p'} \quad (3)$$

This is the formula for double convex lenses; if  $p = \infty$ , that is if the rays are parallel, we have

$$(n-1) \left( \frac{1}{R} + \frac{1}{R'} \right) = \frac{1}{p'}$$

$p'$  being the principal focal distance. If this be represented by  $f$ , we get

$$(n-1) \left( \frac{1}{R} + \frac{1}{R'} \right) = \frac{1}{f} \quad (4)$$

from which the value of  $f$  is easily deduced. Considered in reference to formula (4), the formula (3) assumes the form

$$\frac{1}{p} + \frac{1}{p'} = \frac{1}{f} \quad (5)$$

which is that in which it is usually employed. When the image is virtual  $p'$  changes its sign, and formula (5) takes the form

$$\frac{1}{p} - \frac{1}{p'} = \frac{1}{f} \quad (6)$$

In double concave lenses,  $p'$  and  $f$  retain the same sign, but that of  $p$  changes; the formula (5) becomes then

$$-\frac{1}{p} - \frac{1}{p'} = -\frac{1}{f} \quad (7)$$

The formula (7) may be obtained by the same reasonings as the other.

**546. Combination of lenses.**—If parallel rays fall on a convex lens A, which has the focal distance  $f$ , and then on a similar lens B with the focal distance  $f_1$ , at a distance  $d$  from A, then the distance from the lens B at which the image is formed at F is

$$\frac{1}{F} = \frac{1}{f} + \frac{1}{f-n}$$

If the lenses are close together, so that  $d=0$ , then

$$\frac{1}{F} = \frac{1}{f} + \frac{1}{f_1}$$

the lenses have the same curvature, that is  $f=f_1$ , and then  $\frac{1}{F} = \frac{2}{f}$ , that is to say that the focal distance of the combination is half that of a single lens.

If the second lens is a dispersing one of the focal distance  $f_1$ , then

$$\frac{1}{F} = \frac{1}{f-n} - \frac{1}{f_1}$$

and if the lenses are close together, then

$$\frac{1}{F} = \frac{1}{f} - \frac{1}{f_1}$$

547. **Relative magnitudes of image and object. Determination of focus.**—From the equality of the triangles AOB, aOb (fig. 435) we get for the relative magnitudes of image and object the proportion  $\frac{AB}{ab} = \frac{p}{p_1}$ ;

whence  $\frac{I}{O} = \frac{p'}{p}$  where AB = O is the magnitude of the object and ab = I that of the image; while  $p$  and  $p_1$  are their respective distances from the lens. Replacing  $p_1$  by its value from the equation  $\frac{1}{p} + \frac{1}{p_1} = \frac{1}{f}$  where the image is real, or from the equation  $\frac{1}{p} - \frac{1}{p_1} = \frac{1}{f}$  where it is virtual, we shall

obtain the different values of the ratio  $\frac{I}{O}$  for various positions of the object.

In the first case we have 
$$\frac{I}{O} = \frac{f}{p-f}$$

Thus if  $p > 2f$   $I > O$   
 $p = 2f$   $I = O$   
 $p < 2f$   $I < O$ .

In the second case when the image is virtual we shall have

$$\frac{I}{O} = \frac{f}{f-p}, \text{ so that in all cases } I > O.$$

By using the above formula we may easily deduce the focal length of a convex lens, where direct sunlight is not available. For if it be placed in front of a scale, and if a screen be placed on the other side, then by altering the relative positions of the lens and the screen, a position may be found by trial, such that an image of the object is formed on the screen of exactly the same size. Dividing now by 4, the total distance between the object and the screen, we get the focal distance of the lens.

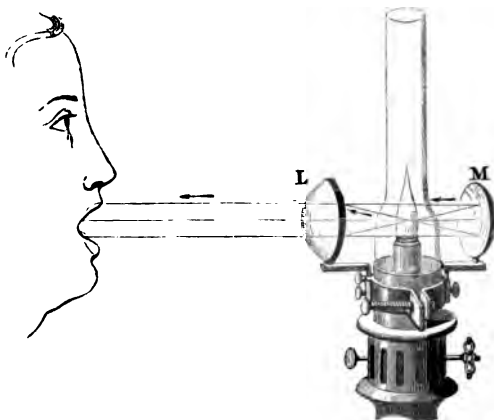

Fig. 440.

548. **Laryngoscope.**—As an application of lenses may be added the laryngoscope, which is an instrument recently invented to facilitate the investi-

gation of the larynx and the other cavities of the mouth. It consists of a plane convex lens *L*, and a concave reflector *M*, both fixed to a ring which can be adjusted to any convenient lamp (fig. 440). The flame of the lamp is in the principal focus of the lens, and at the same time is at the centre of curvature of the reflector. Hence the divergent pencil proceeding from the lamp to the lens is changed after emerging into a parallel pencil. Moreover, the pencil from the lamp impinging upon the mirror, is reflected to the focus of the lens, and traverses the lens forming a second parallel pencil which is supported on the first. This being directed into the mouth of a patient, its condition may be readily observed.

## CHAPTER IV.

### DISPERSION AND ACHROMATISM.

549. **Decomposition of white light. Solar spectrum.**—The phenomenon of refraction is by no means so simple as we have hitherto assumed; when *white* light, or that which reaches us from the sun, passes from one medium into another, it is decomposed into several kinds of light, a phenomenon to which the name *dispersion* is given.

In order to show that white light is decomposed by refraction, a pencil of solar light *SA* (fig. 441), is allowed to pass through a small aperture in the

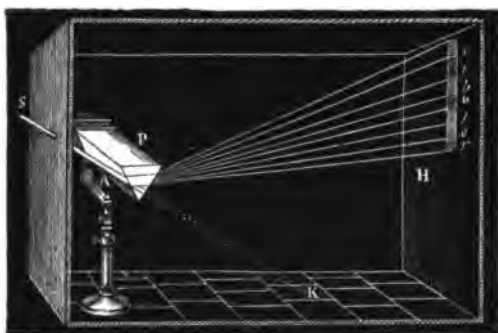

Fig. 441.

window shutter of a dark chamber. This pencil tends to form a round and colourless image of the sun at *K*; but if a flint glass prism, arranged horizontally, be interposed in its path, the beam, on emerging from the prism, becomes refracted towards its base, and produces on a distant screen a vertical band rounded at the ends, coloured in all the tints of the rainbow, which is called the *solar spectrum*, see Plate I. In this spectrum there is, in reality, an infinity of different tints, which imperceptibly merge into each other, but it is customary to distinguish seven principal colours. These are *violet, indigo, blue, green, yellow, orange, red*; they are arranged in this order in the

spectrum, the violet being the most refrangible, and the red the least so. They do not all occupy an equal extent in the spectrum, violet having the greatest extent, and orange the least.

With transparent prisms of different substances, or with hollow glass prisms filled with various liquids, spectra are obtained formed of the same colours, and in the same order; but when the deviation produced is the same, the length of the spectrum varies with the substance of which the prism is made. The angle of separation of two selected rays (say in the red and the violet) produced by a prism is called the *dispersion*, and the ratio of this angle to the mean deviation of the two rays is called the *dispersive power*. This ratio is constant for the same substance so long as the refracting angle of the prism is small. For the deviation of the two rays is proportional to the refracting angle; their difference and their mean vary in the same manner, and, therefore, the ratio of their difference to their mean is constant. For flint glass this is 0.043; for crown glass it is 0.0246; for the dispersive power of flint is almost double that of crown glass.

The spectra which are formed by artificial lights rarely contain all the colours of the solar spectrum; but their colours are found in the solar spectrum, and in the same order. Their relative intensity is almost modified. The shade of colour which predominates in the flame predominates also in the spectrum: yellow, red, and green flames produce spectra in which the dominant tint is yellow, red, or green.

**550. Production of a pure solar spectrum.**—In the above experiment, when the light is admitted through a wide slit, the spectrum formed is built up of a series of overlapping spectra, and the colours are confused and indistinct. In order to obtain a pure spectrum, the slit, in the shutter of the dark room through which light enters, should be from 15 to 25<sup>mm</sup> in height and from 1 to 2<sup>mm</sup> in breadth. The sun's rays are directed upon the slit by a mirror, or still better by a heliostat (520). An achromatic double convex lens is placed at a distance from the slit of double its own focal length, which should be about a metre, and a screen is placed at the same distance from the lens. An image of the slit of exactly the same size is thus formed on the screen (547). If now there is placed near the lens, between it and the screen, a prism with an angle of about 60° and with its refracting edge parallel to the slit, a very beautiful, sharp, and pure spectrum is formed on the screen.

The prism should be free from striæ, and should be placed so that it produces the minimum deviation.

**551. The colours of the spectrum are simple, and unequally refrangible.**—If one of the colours of the spectrum be isolated by intercepting the others by means of a screen, E, as shown in fig. 442, and if the light thus intercepted be allowed to pass through a second prism, B, a refraction will be observed, but the light remains unchanged; that is, the image received on the screen H is violet if the violet pencil has been allowed to pass, blue if the blue pencil, and so on. Hence the colours of the spectrum are *simple*; that is, they cannot further be decomposed by the prism.

Moreover, the colours of the spectrum are unequally refrangible; that is, they possess different refractive indices. The elongated shape of the spectrum would be sufficient to prove the unequal refrangibility of the simple colours, for it is clear that the violet, which is most deflected towards the base

of the prism, is also most refrangible, and that red, which is least reflected, is least refrangible. But the unequal refrangibility of simple colours may be

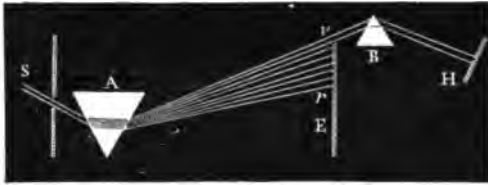

Fig. 442.

shown by numerous experiments, of which the two following may be adduced :—

i. Two narrow strips of coloured paper, one red and the other violet, are fastened close to each other on a sheet of black paper. On looking at them through a prism, they are seen to be unequally displaced, the red band to a less extent than the violet ; hence the red rays are less refrangible than the violet.

ii. The same conclusion may be drawn from Newton's experiment with crossed prisms. On a prism, A (fig. 443), in a horizontal position, a pencil

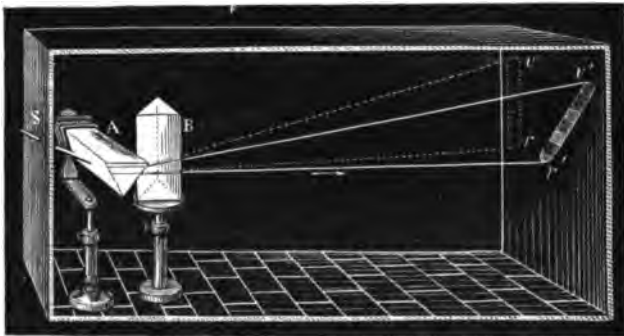

Fig. 443.

of white light, S, is received, which, if it had merely traversed the prism A, would form the spectrum  $rv$ , on a distant screen. But if a second prism, B, be placed in a vertical position behind the first, in such a manner that the refracted pencil passes through it, the spectrum  $rv$  becomes deflected towards the base of the vertical prism : but, instead of being deflected in a direction parallel to itself, as would be the case if the colours of the spectrum were equally refracted, it is obliquely refracted in the direction  $r'v'$ , proving that from red to violet the colours are more and more refrangible.

These different experiments show that the refractive index differs in different colours ; even rays which are to perception undistinguishable have not the same refractive index. In the red band, for instance, the rays at the extremity of the spectrum are less refracted than those which are nearer the

orange zone. In calculating indices of refraction (524), it is usual to take as the index of any particular substance the refrangibility of the yellow ray in a prism formed of that substance.

552. **Recomposition of white light.**—Not merely can white light be resolved into lights of various colours, but by combining the different pencils

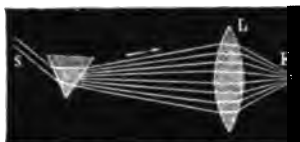

Fig. 444.



Fig. 445.

separated by the prism, white light can be reproduced. This may be effected in various ways :—

i. If the spectrum produced by one prism be allowed to fall upon a second prism of the same material, and the same refracting angle as the first, but inverted, as shown in fig. 445, the latter reunites the different colours of the spectrum, and it is seen that the emergent pencil E, which is parallel to the pencil S, is colourless.

ii. If the spectrum falls upon a double convex lens (fig. 444), a white image of the sun will be formed on a white screen placed in the focus of the lens ; a glass globe filled with water produces the same effect as the lens.



Fig. 446.

iii. When the spectrum falls upon a concave mirror, a white image is formed on a screen of ground glass placed in its focus (fig. 446).

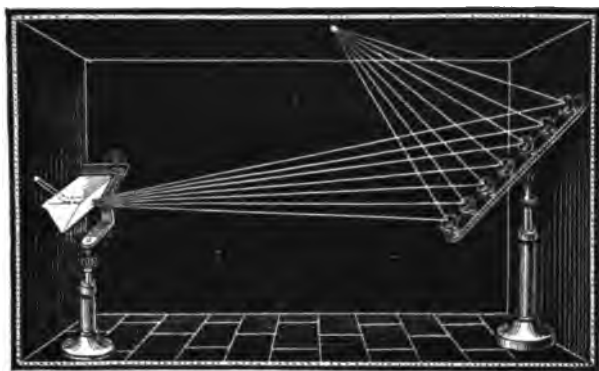

Fig. 447.

iv. Light may be recomposed by means of a pretty experiment, which consists in receiving the seven colours of the spectrum on seven small glass



mirrors with plane faces, and which can be so inclined in all positions that the reflected light may be transmitted in any given direction (fig. 447). When these mirrors are suitably arranged, the seven reflected pencils may be caused to fall on the ceiling in such a manner as to form seven distinct images—red, orange, yellow, etc. When the mirrors are moved so that the separate images become superposed, a single image is obtained, which is white.

v. By means of *Newton's disc*, fig. 448, it may be shown that the seven colours of the spectrum form white. This is a cardboard disc of about a foot in diameter; the centre and the edges are covered with black paper, while in the space between there are pasted strips of papers of the colours of the spectrum. They proceed from the centre to the circumference, and their relative dimensions and tints are such as to represent five spectra (fig. 449).

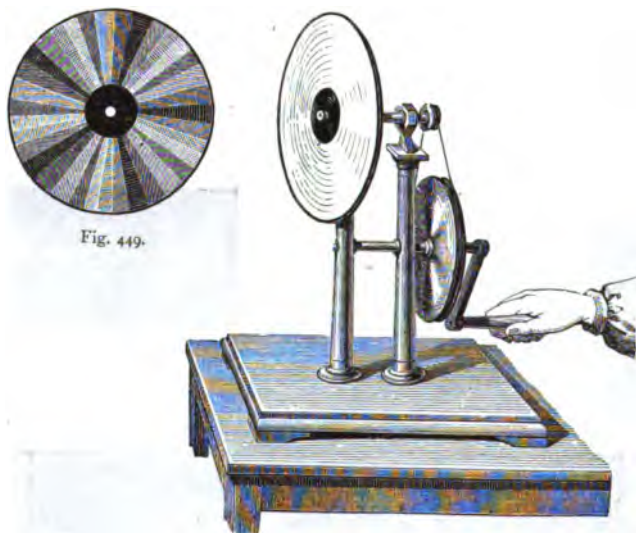

Fig. 449.

Fig. 448.

When this disc is rapidly rotated, the effect is the same as if the retina received simultaneously the impression of the seven colours.

vi. If by a mechanical arrangement, a prism, on which the sun's light falls, is made to oscillate rapidly, so that the spectrum also oscillates, the middle of the spectrum appears white.

These latter phenomena depend on the physiological fact, that sensation always lasts a little longer than the impression from which it results. If a new impression is allowed to act, before the sensation arising from the former one has ceased, a sensation is obtained consisting of two impressions. And by choosing the time short enough, three, four, or more impressions may be mixed with each other. With a rapid rotation the disc is nearly white. It is not quite so, for the colours cannot be exactly arranged in the same proportions as those in which they exist in the spectrum, and *pigment*

colours are not pure. A similar explanation applies to the experiment of the oscillating prism.

553. **Newton's theory of the composition of light.**—Newton was the first to decompose white light by the prism, and to recompose it. From the various experiments which we have described, he concluded that white light was not homogeneous, but formed of seven lights unequally refrangible, which he called *simple* or *primitive* lights. Owing to the difference in refrangibility they become separated in traversing the prism.

The designation of the various colours of the spectrum is to a very great extent arbitrary ; for in strict accuracy, the spectrum is made up of an infinite number of simple colours, which pass into one another by imperceptible gradations of colour and refrangibility.

554. **Colour of bodies.**—The natural colour of bodies results from the fact that of the coloured rays contained in white light, one portion is absorbed at the surface of the body. If the unabsorbed portion traverses the body, it is coloured and transparent ; if, on the contrary, it is reflected, it is coloured and opaque. In both cases the colour results from the constituents which have not been absorbed. Those which reflect or transmit all colours in the proportion in which they exist in the spectrum are white ; those which reflect or transmit none are black. Between these two limits there are infinite tints according to the greater or less extent to which bodies reflect or transmit some colours and absorb others. Thus a body appears yellow, because it absorbs all colours with the exception of yellow. In like manner, a solution of ammoniacal oxide of copper absorbs preferably the red and yellow rays, transmits the blue rays almost completely, the green and violet less so, hence the light seen through it is blue.

Hence bodies have no colour of their own ; with the nature of the incident light the colour of the body changes. Thus, if in a dark room a white body be successively illuminated by each of the colours of the spectrum, it has no special colour but appears red, orange, green, etc., according to the position in which it is placed. If homogeneous light falls upon a body, it appears brighter in the colour of this light, if it does not absorb this colour ; but black if it does absorb it. In the light of a lamp fed by spirit in which some common salt is dissolved, everything white and yellow seems bright, while most of the other colours are black. This is well seen in the case of a stick of red sealing-wax viewed in such a light. In the light of lamps and of candles, which from the want of blue rays appear yellow, yellow and white appear the same, and blue seems like green. In bright twilight or in moonshine, the light of gas has a reddish tint.

555. **Mixed colours. Complementary colours.**—By mixed colours we understand the impression of colour which results from the coincident action of two or more colours on the same position of the retina. This new impression is single ; it cannot be resolved into its components ; in this respect it differs from a complex sound in which the ear by practice can distinguish the constituents. Mixed colours may be produced by causing different parts of the spectrum to cover each other ; they may also be produced by looking in an oblique direction through a vertical glass plate at a coloured surface ; while at the same time, the observer's side of the plate reflects

towards his eye light of a different colour. The method of the coloured disc affords another means of producing mixed colours.

If in any of the methods by which the impression of mixed spectral colours is produced, one or more colours be suppressed, the residue corresponds to one of the tints of the spectrum ; and the mixture of the colours taken away produces the impression of another spectral colour. Thus, if in fig. 444 the red rays are cut off from the lens L, the light on the focus is no longer white but greenish blue. In like manner if the violet, indigo, and blue of the colour disc be suppressed, the rest seems yellow, while the mixture of that which has been taken out is a bluish violet. Hence white can always be compounded of *two* tints ; and two tints which together give white are called *complementary colours*. Thus of spectral tints *red* and *greenish yellow* are complementary, so are *orange* and *prussian blue* ; *yellow* and *indigo blue* ; *greenish yellow* and *violet*.

A distinction must be made between *spectral colours* and *pigment colours*. Thus a mixture of pigment yellow and pigment blue produces green and not white, as is the case when the blue and yellow of the spectrum are mixed. The reason of this is that in the mixture of pigments we have a case of subtraction of colours and not of addition. For in the mixture the pigment blue absorbs almost entirely the yellow and red light ; and the pigment yellow absorbs the blue and violet light so that only the green remains.

If the complementary spectral colours are mixed in other proportions than is requisite for the production of white, intermediate colours are obtained which lie in the spectrum between the tints of the complementary colours. Thus a mixture of red and greenish blue, in which the former predominates, produces a tint which is nearer orange ; while when the latter is in excess, the tint comes nearer yellow and ultimately green. These colours, however, are not so pure as the corresponding spectral tints. They are less *saturated*, as it is called ; that is, mixed with white.

In the above series are two spectral colours very remote in the spectrum which have nearly the same complementary colours : these are red, the complementary colour to which is greenish blue, and violet, whose complementary colour is greenish yellow. Now when two pairs of complementary colours are mixed together, they must produce white just as if only two complementary colours were mixed. But a mixture of greenish blue and of greenish yellow is green. Hence it follows that from a mixture of red, green, and violet white must be formed. This may easily be ascertained to be the case, by means of a colour disc on which are these three colours in suitable proportions.

From the above facts it follows that from a mixture of red, green, and violet all possible colours may be constructed, and hence these three spectral colours are called the *fundamental colours*. It must be remarked that the tints resulting from the mixture of these three have never the saturation of the individual spectral colours.

We have to discriminate three points in regard to *colour*. In the first place, the *tint* or colour proper by which we mean that special property which is due to a definite refrangibility producing it ; secondly, the *saturation* which depends on the greater or less admixture of white light with

the colours of the spectrum, these being colours which are fully saturated; and thirdly, there is the *intensity* which depends on the amplitude of vibration.

556. **Homogeneous light.**—The light emitted from luminous bodies is seldom or never quite pure; on being examined by the prism it will be found to contain more than one colour. In optical researches it is frequently of great importance to procure *homogeneous* or *monochromatic* light. Common salt in the flame of a Bunsen's lamp gives a yellow of great purity. For red light, ordinary light is transmitted through glass coloured with suboxide of copper, which absorbs nearly all the rays excepting the red. A very pure blue is obtained by transmitting ordinary light through a glass trough containing an ammoniacal solution of sulphate of copper, and a nearly pure red by transmitting it through a solution of sulphocyanide of iron.

557. **Properties of the spectrum.**—Besides its luminous properties, the spectrum is found to produce calorific and chemical effects.

*Luminous properties.* It appears from the experiments of Fraunhofer and of Herschel, that the light in the yellow part of the spectrum has the greatest intensity, and that in the violet the least.

*Heating effects.* It was long known that the various parts of the spectrum differed in their calorific effects. Leslie found that a thermometer placed in different parts of the spectrum indicated a higher temperature as it moved from violet towards red. Herschel fixed the maximum intensity of the heating effects just outside the red; Berard in the red itself. Seebeck showed that those different effects depend on the nature of a prism: with a prism of water the greatest calorific effect is produced in the yellow; with one of alcohol it is in the orange-yellow; and with a prism of crown glass it is in the middle of the red.

Melloni, by using prisms and lenses of rock salt, and by availing himself of the extreme delicacy of the thermo-electric apparatus, first made a complete investigation of the calorific properties of the thermal spectrum. This result led, as we have seen, to the confirmation and extension of Seebeck's observations.

*Chemical properties.* In numerous phenomena, light acts as a chemical agent. For instance, chloride of silver blackens under the influence of light; transparent phosphorus becomes opaque; vegetable colouring matters fade; hydrogen and chlorine gases, when mixed, combine slowly in diffused light, and with explosive violence when exposed to direct sunlight. The chemical action differs in different parts of the spectrum. Scheele found that when chloride of silver was placed in the violet, the action was more energetic than in any other part. Wollaston observed that the action extended beyond the violet, and concluded that, besides the visible rays, there are some invisible and more highly refrangible rays. These are the chemical or *actinic* rays.

The researches of Bunsen and Roscoe show that whenever chemical action is induced by light, an absorption of light takes place, preferably of the more refrangible parts of the spectrum. Thus, when chlorine and hydrogen unite, under the action of light, to form hydrochloric acid light is absorbed, and the quantity of chemically active rays consumed is directly proportional to the amount of chemical action.

There is a curious difference in the action of the different rays. Moser placed an engraving on an iodised silver plate, and exposed it to the light until an action had commenced, and then placed it under a violet glass in the sunlight. After a few minutes a picture was seen with great distinctness, while when placed under a red or yellow glass, it required a very long time, and was very indistinct. When, however, the iodized silver plate was first exposed in a camera obscura to blue light for two minutes, and was then brought under a red or yellow glass, an image quickly appeared, but not when placed under a green glass. It appears as if there are vibrations of a certain velocity which could commence an action, and that there are others which are devoid of the property of commencing, but can continue and complete an action when once set up. Becquerel, who discovered these properties in luminous rays, called the former *exciting rays*, and the latter *continuing* or *phosphorogenic rays*. The phosphorogenic rays, for instance, have the property of rendering certain objects self-luminous in the dark after they have been exposed for some time to the light. Becquerel found that the phosphorogenic spectrum extended from indigo to beyond the violet.

558. **Dark lines of the spectrum.**—The colours of the solar spectrum are not continuous. For several grades of refrangibility rays are wanting, and in consequence, throughout the whole extent of the spectrum, there



Fig. 450.

are a great number of very narrow dark lines. To observe them, a pencil of solar rays is admitted into a darkened room, through a narrow slit. At a distance of three or four yards, we look at this slit through a prism of flint glass, which must be very free from flaws, taking care to hold its

edge parallel to the slit. We then observe a great number of very delicate dark lines parallel to the edge of the prism, and at very unequal intervals.

The existence of the dark lines was first observed by Wollaston in 1802 ; but Fraunhofer, a celebrated optician of Munich, first studied and gave a detailed description of them. Fraunhofer mapped the lines, and indicated the most marked of them by the letters A, *a*, B, C, D, E, *b*, F, G, H ; they are therefore generally known as Fraunhofer's lines.

The dark line A (see fig. 2 of Plate I.), is at the extremity and B in the middle of the red ray ; C at the boundary of the red and orange ray ; D is in the yellow ray ; E, in the green ; F, in the blue ; G, in the indigo ; H, in the violet. There are certain other noticeable dark lines, such as *a* in the red, and *b* in the green. In the case of solar light the positions of the dark lines are fixed and definite ; on this account they are used for obtaining an exact determination of the refractive index (524) of each colour ; for example, the refractive index of the blue ray is, strictly speaking, that of the dark line F. In the spectra of artificial lights, and of the stars, the relative positions of the dark lines are changed. In the electric light the dark lines are replaced by brilliant lines. In coloured flames, that is to say, flames in which certain chemical substances undergo evaporation, the dark lines are replaced by very brilliant lines of light, which differ for different substances. Lastly, of the dark lines, some are constant in position and distinctness, such as Fraunhofer's lines ; but some of the lines only appear as the sun nears the horizon, and others are strengthened. They are also influenced by the state of the atmosphere. The fixed lines are due to the sun ; the variable lines have been proved by Janssen and Secchi to be due to the aqueous vapour in the air, and are called atmospheric or *telluric* lines.

Fraunhofer counted in the spectrum more than 600 dark lines, more or less distinct, distributed irregularly from the extreme red to the extreme violet ray. Brewster counted 2,000. By causing the refracted rays to pass successively through several analysing prisms, not merely has the existence of 3,000 dark lines been ascertained, but several which had been supposed single have been shown to be compound.

**559. Applications of Fraunhofer's lines.**—Subsequently to Fraunhofer, several physicists studied the dark lines of the spectrum. In 1822 Sir J. Herschel remarked that by volatilising substances in a flame a very delicate means is afforded of detecting certain ingredients by the colours they impart to certain of the dark lines of the spectrum ; and Fox Talbot in 1834 suggested optical analysis as probably the most delicate means of detecting minute portions of a substance. To Kirchhoff and Bunsen, however, is really due the merit of basing on the observation of the lines of the spectrum a method of analysis. They ascertained that the salts of the same metal, when introduced into a flame, always produce lines identical in colour and position, but different in colour, position, or number for different metals, and finally that an exceedingly small quantity of a metal suffices to disclose its existence. Hence has arisen a new method of analysis, known by the name of *spectrum analysis*.

**560. Spectroscope.**—The name of spectroscope has been given to the apparatus employed by Kirchhoff and Bunsen for the study of the spectrum. One of the forms of this apparatus is represented in fig 450. It is composed

of three telescopes mounted on a common foot, and whose axes converge towards a prism, *P*, of flint-glass. The telescope *A* is the only one which can turn round the prism. It is fixed in any required position by a clamping screw *n*. The screw-head, *m*, is used to shift the position of the eye-piece, so that a clear image of the spectrum may be obtained, or, in other words, to focus the eye-piece. The screw-head *n* is used to change the inclination of the axis.

To explain the use of the telescopes *B* and *C*, we must refer to fig. 451, which shows the passage of the light through the apparatus. The rays

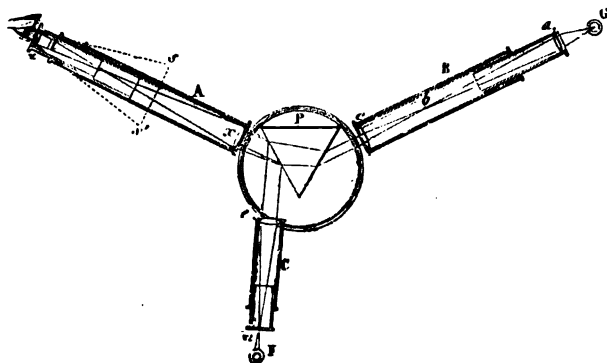

Fig. 451.

emitted by the flame *G* falls on the lens *a*, and are caused to converge to a point, *b*, which is the principal focus of a second lens *c*. Consequently the pencil, on leaving the telescope *B*, is formed of parallel rays. This pencil enters the prism *P*. On leaving the prism, the light is decomposed, and in this state falls on the lens *x*. By this lens *x*, a real and reversed image of the spectrum is formed at *i*. This image is seen by the observer through a magnifying glass which forms at *ss'* a virtual image of the spectrum magnified about eight times.

The telescope *C* serves to measure the relative distances of the lines of the spectrum. For this purpose there is placed at *m* a micrometer divided into 25 equal parts. The micrometer is formed thus:—a scale of 250 millimetres is divided with great exactness into 25 equal parts. A photographic negative on glass of this scale is taken, reduced to 15 millimetres. The negative is taken because then the scale is light on a dark ground. The scale is then placed at *m* in the principal focus of the lens *e*; consequently, when the scale is lighted by the candle *F*, the rays emitted from it leave the lens *e* in parallel pencils; a portion of these, being reflected from a face of the prism, passes through a lens *x*, and forms a perfectly distinct image of the micrometer at *i*, thereby furnishing the means of measuring exactly the relative distances of the different spectral lines.

The micrometric telescope *C* (fig. 450) is furnished with several adjusting screws, *i*, *o*, *r*: of these *i* adjusts the focus; *o* displaces the micrometer

in the direction of the spectrum laterally ;  $r$  raises or lowers the micrometer, which it does by giving different inclinations to the telescope.

The opening whereby the light of the flame G enters the telescope B consists of a narrow vertical slit, which can be opened more or less by causing the movable piece  $a$  to advance or recede by means of the screw  $v$  (fig. 452). When for purposes of comparison two spectra are to be examined simultaneously, there is placed over the upper part of the slit a small prism, whose refracting angle is  $60^\circ$ . Rays from one of the flames, H, fall at right angles on one face of the prism, they then experience total reflection on a second face, and leave the prism by the third face, and in a direction at right angles to that face. By this means they pass into the telescope in a direction parallel to its axis, without in any degree mixing with the rays which proceed from the second flame, G. Consequently, the two pencils of rays traverse the prism P (fig. 451), and form two horizontal spectra which are viewed simultaneously through the telescope A. In the flames G and H are platinum wires,  $e, e'$ . These wires have been dipped beforehand into solutions of the salts of the metals on which experiment is to be made ; and by the vaporisation of these salts the metals modify the transmitted light, and give rise to definite lines.



Fig. 452.

Each of the flames F and G is a jet of ordinary gas. The apparatus through which the gas is supplied is known as a *Bunsen's burner*. The gas comes through the hollow stem  $k$  (fig. 450). At the lower part of this there is a lateral orifice which admits air to support the combustion of the gas. This orifice can be more or less closed by a small diaphragm, which acts as a regulator. If we allow a moderate amount of air to enter, the gas burns with a luminous flame, and the lines are obscured. But if a strong and steady current of air enters, the carbon is rapidly oxidised, the flame loses its brightness, and burns with a pale blue light, but with an intense heat. In this state it no longer yields a spectrum. If, however, a metallic salt is introduced either in a solid state or in a state of solution, the spectrum of the metal makes its appearance, and in a fit state for observation.

There are three chief types of spectra : the *continuous* spectrum, or those furnished by ignited solids and liquids (fig. 1, Plate I.) ; the *band* or *line* spectrum, consisting of a number of bright lines, and produced by ignited gases or vapours ; and *absorption* spectra, or those furnished by the sun or fixed stars. For an explanation of these, see art. 562. Bodies at a red heat give only a small spectrum, extending at most to the orange ; as the temperature gradually rises, yellow, green, blue, and violet successively appear, while the intensity of the lower colours increases.

Instead of the prism very pure spectra may also be obtained by means of a grating (629).



561. **Experiments with the spectroscope.**—The coloured plate at the beginning shows certain spectra observed by means of the spectroscope. No. 1 represents the continuous spectrum.

No. 2 shows the spectrum of sodium. The spectrum contains neither red, orange, green, blue, nor violet. It is marked by a very brilliant yellow ray in exactly the same position as Fraunhofer's dark line D. Of all metals sodium is that which possesses the greatest spectral sensibility. In fact, it has been ascertained that one two-hundred-millionth of a grain of sodium is enough to cause the appearance of the yellow line. Consequently, it is very difficult to avoid the appearance of this line. A very little dust scattered in the apartment is enough to produce it,—a circumstance which shows how abundantly sodium is distributed throughout nature.

No. 3 is the spectrum of *lithium*. It is characterised by a well-marked line in the red called  $Li\alpha$ , and by the feebler orange line  $Li\beta$ .

Nos. 4 and 5 show the spectra of *cæsium* and *rubidium*, metals discovered by Bunsen and Kirchhoff by means of spectrum analysis. The former is distinguished by two blue lines  $Cs\alpha$  and  $Cs\beta$ , the latter by two very brilliant dark red lines  $Rb\gamma$  and  $Rb\delta$ , and by two less intense violet lines  $Rb\alpha$  and  $Rb\beta$ . A third metal, *thallium*, has been discovered by the same method by Mr. Crookes in England, and independently by M. Lamy in France. Thallium is characterised by a single green line. Subsequently to this Richter and Reich discovered a new metal associated with zinc, and which they call *indium* from a couple of characteristic lines which it forms in the indigo, and quite recently M. Boisbaudran has discovered a new metal existing in zinc in very minute quantities.

The extreme delicacy of the spectrum reactions, and the ease with which they are produced, constitute them a most valuable help in the quantitative analysis of the alkalis and alkaline earths. It is sufficient to place a small portion of the substance under examination on platinum wire as represented in fig. 452, and compare the spectrum thus obtained either directly with that of another substance, or with the charts in which the positions of the lines produced by the various metals are laid down.

With other metals the production of their spectra is more difficult, especially in the case of some of their compounds. The heat of a Bunsen's burner is insufficient to vaporise the metals, and a more intense temperature must be used. This is effected by taking electric sparks between wires consisting of the metal whose spectrum is required, and the electric sparks are most conveniently obtained by means of Ruhmkorff's coil or inductorium. Thus all the metals may be brought within the sphere of spectrum observations.

The power of the apparatus has great influence on the nature of the spectrum ; while an apparatus with one prism only gives in a sodium flame the well-known yellow line, an apparatus with more prisms resolves it into two or three lines.

It has been observed that the character of the spectrum changes with the temperature ; thus chloride of lithium in the flame of a Bunsen's burner gives a single intense peach-coloured line ; in a hotter flame, as that of hydrogen, it gives an additional orange line ; while in the oxy-hydrogen jet or the voltaic arc a broad brilliant blue band comes out in addition. The sodium

spectrum produced by a Bunsen's burner consists of a single yellow line ; if, by the addition of oxygen, the heat be gradually increased, more bright lines appear ; and with the aid of the oxy-hydrogen flame the spectrum is continuous. Sometimes also, in addition to the appearance of new lines, an increase in temperature resolves those bands which exist into a number of fine lines, which in some cases are more and in some less refrangible than the bands from which they are formed. It may be supposed that the glowing vapour found at the low temperature consists of the oxide of some difficultly reducible metal, whereas at the enormously high temperature of the spark these compounds are decomposed, and the true bright lines of the metal are formed.

The delicacy of the reaction increases very considerably with the temperature. With the exception of the alkalis, it is from 40 to 400 times greater at the temperature of the electric spark than at that of Bunsen's burner.

The spectra of the permanent gases are best obtained by taking the electric spark of a Ruhmkorff's coil, or Holtz's apparatus, through glass tubes of a special construction, provided with electrodes of platinum and filled with the gas in question in a state of great attenuation, known as *Geissler's tubes* ; if the spark be passed through hydrogen, the light emitted is bright red, and its spectrum consists of one bright red, one green, and one blue line No. 7, the first two of which appear to coincide with Fraunhofer's lines C and F, and the third with a line between F and G. No. 6 represents the spectrum of oxygen. No. 8 is the spectrum of nitrogen. The light of this gas in a Geissler's tube is purple and the spectrum very complicated.

If the electric discharge take place through a compound gas or vapour, the spectra are those of the elementary constituents of the gas. It seems as if at very intense temperatures chemical combination was impossible, and oxygen and hydrogen, chlorine and the metals, could coexist in a separate form, although mechanically mixed with each other.

The nature of the spectra of the elementary gases is very materially influenced by alterations of temperature and pressure. Wüllner made a series of very accurate observations on the gases oxygen, hydrogen, and nitrogen. He not only used gases in closed tubes, which by various electrical means he raised to different temperatures ; but in one and the same series of experiments, in which a small inductorium was used, he employed pressures varying from 100 millimetres to a fraction of a millimetre ; while in another series, in which a larger apparatus was used, he extended the pressure to 2,000 millimetres. At the lowest pressure of less than one millimetre, the spectrum of hydrogen was found to be green, and consisting of six splendid groups of lines, which at a higher pressure than 1 millimetre changed to continuous bands ; at 2 to 3 millimetres the spectrum consisted of the often-mentioned three lines, which did not disappear under a higher pressure, but gradually became less brilliant as the continuous spectrum increased in extent and lustre. From this point the light, and therefore the spectrum, became feebler. Using the larger apparatus, the band spectrum appeared only under a higher pressure ; at the highest pressure of 2,000 millimetres it gave

place to the continuous spectrum, since the bright lines continually extended and ultimately merged into each other.

562. **Explanation of the dark lines of the solar spectrum.**—It has been already seen that incandescent sodium vapour gives a bright yellow line corresponding to the dark line D of the solar spectrum. Kirchhoff found that, when the brilliant light produced by incandescent lime passes through a flame coloured by sodium in the usual manner, a spectrum is produced in which is a dark line coinciding with the dark line D of the solar spectrum; what would have been a bright yellow line becomes a dark line when formed on the background of the lime light. By allowing in a similar manner the lime light to traverse vapours of potassium, barium, strontium, etc., the bright lines which they would have formed were found to be converted into dark lines: such spectra are called *absorption spectra*.

It appears then that the vapour of sodium has the power of absorbing rays of the same refrangibility as that which it emits. And the same is true of the vapours of potassium, barium, strontium, etc. This absorptive power is by no means an isolated phenomenon. These substances share it, for example, with the vapour of nitrous acid, which Brewster found to possess the following property: when a tube filled with this vapour is placed in the path of the light either of the sun or of a gas flame, and the light is subsequently decomposed by a prism, a spectrum is produced which is full of dark lines (No. 9, Plate I.); and Miller showed that iodine and bromine vapour produced analogous effects.

Hence the origin of the above phenomenon is, doubtless, the absorption by the sodium vapour of rays of the same kind, that is, having the same refrangibility, as those which it has itself the power of emitting. Other rays it allows to pass unchanged, but these it either totally or in great part suppresses. Thus the particular lines in the spectrum to which these rays would converge are illuminated only by the feebly luminous sodium flame, and accordingly appear dark by contrast with the other portions of the spectrum which receive light from the powerful flame behind.

By replacing one of the flames, G or F (fig. 450), by a ray of solar light reflected from a heliostat, Kirchhoff ascertained by direct comparison that the bright lines which characterise iron correspond to dark lines in the solar spectrum. He also found the same to be the case with sodium, magnesium, calcium, nickel, and some other metals.

From these observations we may draw important conclusions with respect to the constitution of the sun. Since the solar spectrum has dark lines where sodium, iron, etc., give bright ones (No. 11, Plate I.), it is probable that around the solid, or more probably liquid, body of the sun, which throws out the light, there exists a vaporous envelope which, like the sodium flame in the experiment described above, absorbs certain rays, namely, those which the envelope itself emits. Hence those parts of the spectrum which, but for this absorption, would have been illuminated by these particular rays, appear feebly luminous in comparison with the other parts, since they are illuminated only by the light emitted by the envelope, and not by the solar nucleus; and we are at the same time led to conclude that in this vapour there exist the metals sodium, iron, etc.

Huggins and Miller have applied spectrum analysis to the investigation

of the heavenly bodies. The spectra of the moon and planets, whose light is reflected from the sun, give the same lines as those of the sun. Uranus proves an exception to this, and is probably still in a self-luminous condition. The spectra of the fixed stars contain, however, dark lines differing from the solar lines, and from one another. Four distinct types of spectra are distinguished by Secchi. The first embraces the white stars and includes the well-known Sirius and  $\alpha$  Lyræ. Their spectra (No. 12, Plate I.) usually contain a number of very fine lines, and always contain four broad dark lines which coincide with the bright lines of hydrogen. Out of 346 stars 164 were found to belong to this group. The second group embraces those having spectra intersected by numerous fine lines like those of our sun. About 140 stars, among them Pollux, Capella,  $\phi$  Aquilæ, belong to this group. The third group embraces the red and orange stars, such as  $\alpha$  Orionis,  $\beta$  Pegasi; the spectra of these (Nos. 13, 14, Plate I.) are divided into eight or ten parallel columnar clusters of dark and bright bands increasing in intensity to the red. Group four is made up of small red stars with spectra, and is constructed of three bright zones increasing in intensity towards the violet. It would thus appear that these fixed stars, while differing from one another in the matter of which they are composed, are constructed on the same general plan as our sun. Huggins has observed a striking difference in the spectra of the nebulæ; where they can at all be observed, they are found to consist generally of bright lines, like the spectra of the ignited gases, instead of like the spectra of the sun and stars consisting of a bright ground intersected by dark lines. It is hence probable that the nebulæ are masses of glowing gas, and do not consist, like the sun and stars, of a photosphere surrounded by a gaseous atmosphere.

One of the most interesting triumphs of spectrum analysis has been the discovery of the true nature of the *protuberances*, which appear during a solar eclipse as mountains or cloud-shaped luminous objects varying in size, and surrounding the moon's disc.

During the eclipse of 1868 it had been ascertained by Janssen that protuberances emitted certain bright lines coinciding with those of hydrogen. They have, however, been fully understood only since Lockyer and Janssen have discovered a method of investigating them at any time. The principle of this method is as follows:—When a line of light admitted through a slit is decomposed by a prism, the length of the spectrum may be increased by passing it through two or more prisms; as the quantity of light is the same, it is clear that the intensity of the spectrum will be diminished. This is the case with the ordinary sources of light, such as the sun; if the light be homogeneous, it will be merely deviated, and not reduced in intensity by dispersion. And if the source of light emit lights of both kinds, the image of the slit of light of a definite refrangibility, which the mixture may contain, will stand out by its superior intensity on the weaker ground of the continuous spectrum. This is the case with the spectrum of the protuberances. Viewed through an ordinary spectroscope, the light they emit is overshadowed by that of the sun; but by using prisms of great dispersive power the sun's light becomes weakened, and the spectrum of the protuberances may be observed. Lockyer's researches leave no doubt that they are ignited gas masses, principally of hydrogen. By altering the position of the slit a series

of sections of the prominences are obtained, by collating which the form of the prominence may be inferred. They are thus found to enclose the sun usually to a depth of about 5,000 miles, but sometimes in enormous local accumulations, which reach the height of 70,000 miles. Lockyer has not merely examined these phenomena right on the edge of the sun; but he has been able to observe them on the disc itself. He has shown that some of these protuberances are the results of sudden outbursts or storms, which move with the enormous velocity of 120 miles in a second.

For a fuller account of this branch of Physics, which is incompatible with the limits of this work, the reader is referred to Roscoe's 'Lectures on Spectrum Analysis,' and to the same writer's articles in Watts's 'Dictionary of Chemistry,' or to Schellen's 'Spectrum Analysis,' translated by Lassell, or to Lockyer 'On the Spectroscope.'

563. **Uses of the spectroscope.**—When a liquid placed in a glass tube or in a suitable glass cell is interposed between a source of light and the slit of the spectroscope, on looking through the telescope, the spectrum observed will in many cases be found to be traversed by dark bands. No. 10, Plate I, represents the appearance of the spectrum when a solution of *chlorophylle*, the green colouring matter of plants is thus interposed. Both in the red, the yellow, and the violet parts, dark bands are formed, and the blue gives way to a reddish shimmer. If, instead of chlorophylle, arterial blood greatly diluted be used, the red of the spectrum appears brighter, but green and violet are nearly extinguished. As these bands thus differ in different liquids as regards position, breadth, and intensity, in many cases they afford the most suitable means of identifying bodies. Sorby and Browning have devised a combination of the microscope and spectroscope, called the *microspectroscope*, which renders it possible to examine even very minute traces of substances.

This application of the spectroscope has been very useful in investigating substances which have special importance in physiology and pathology; thus in examining normal and diseased blood, in detecting albumen in urine, and in ascertaining the rate at which certain substances pass into the various fluids of the system. The characteristic absorption bands which certain liquids, such as wine, beer, etc., present in their normal state, compared with those yielded by adulterated substances, furnishes a delicate and certain mean of detecting the latter.

564. **Fluorescence.**—Professor Stokes has made the remarkable discovery that under certain circumstances the rays of light are capable of undergoing a change of refrangibility. The discovery originated in the study of a phenomenon observed by Sir J. Herschel, that certain solutions when looked at by transmitted light appear colourless, but when viewed in reflected light present a bluish appearance. Stokes has found that this property, which he calls *fluorescence*, is characteristic of a large class of bodies.

The phenomenon is best seen when a solution of sulphate of quinine, contained in a trough with parallel sides, is placed in different positions in the solar spectrum. No change is observed in the upper part of the spectrum, but from about the middle of the lines G and H (coloured Plate) to some distance beyond the extreme range of the violet, rays of a beautiful sky-blue colour are seen to proceed. These invisible ultra-violet rays also become visible when the spectrum is allowed to fall on paper impregnated

with a solution of *asculine* (a substance extracted from horse-chestnut), an alcoholic solution of stramonium, or a plate of canary glass (which is coloured by means of uranium). This change arises from a diminution in the refrangibility of those rays outside the violet, which are ordinarily too refrangible to affect the eye.

Glass appears to absorb many of these more refrangible rays, which is not the case nearly to the same extent with quartz. When a prism and trough formed of plates of quartz are used, and the spectrum is received on a sheet of paper on which a wash of solution of sulphate of quinine has been made, two juxtaposed spectra can be obtained. That which is on the part coated with sulphate of quinine extends beyond the line H to an extent equal to that of the visible spectrum. In the spectrum thus made visible dark lines may be seen like those in the ordinary spectrum.

The phenomena may be observed without the use of a prism. When an aperture in a dark room is closed by means of a piece of blue glass, and the light is allowed to fall upon a piece of canary glass, it instantly appears self-luminous from the emission of the altered rays. If a test tube be half filled with a solution of sulphate of quinine and on it be poured an ethereal solution of chlorophylle, the respective layers appear colourless, and green in transmitted, and sky-blue and blood-red in reflected light.

In most cases it is the violet and ultra-violet rays which undergo an alteration of refrangibility, but the phenomenon is not confined to them. A decoction of madder in alum gives yellow and violet light from about the line D to beyond the violet; an alcoholic solution of chlorophylle gives red light from the line B to the limit of the spectrum. In these cases the yellow, the green, and the blue rays experience diminution of refrangibility; the change produces more highly refrangible rays. An exception to this rule is met with in the case of Magdala red. If on a solution of this substance contained in a rectangular glass vessel a solar spectrum be allowed to fall, an orange yellow fluorescence is found even in the red part of the spectrum.

The electric light gives a very remarkable spectrum. With quartz apparatus Stokes obtained a spectrum six or eight times as long as the ordinary one. Several flames of no great illuminating power emit very peculiar light. Characters traced on paper with solution of stramonium, which are almost invisible in daylight, appear instantaneously when illuminated by the flame of burning sulphur. Robinson has found that the light of the aurora is peculiarly rich in rays of high refrangibility.

565. **Chromatic aberration.**—The various lenses hitherto described (537) possess the inconvenience that, when at a certain distance from the eye, they give images with coloured edges. This defect, which is most observable in condensing lenses, is due to the unequal refrangibility of the simple colours (551), and is called *chromatic aberration*.

For, as a lens may be compared to a series of prisms with infinitely small faces, and united at their bases, it not only refracts light, but also decomposes it like a prism. On account of this dispersion, therefore, lenses have really a distinct focus for each colour. In condensing lenses, for example, the red rays, which are the least refrangible, form their focus at a point, R, on the axis of the lens (fig. 453), while the violet rays, which are most refrangible, coincide in the nearer point, V. The foci of

the orange, yellow, green, blue, and indigo are between these points. The chromatic aberration is more perceptible in proportion as the lenses are

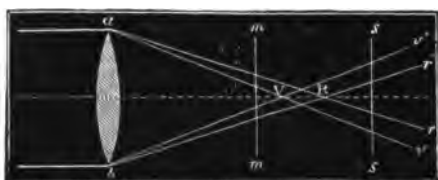

Fig. 453.

more convex, and as the point at which the rays are incident is farther from the axis; for then the deviation, and therefore the dispersion, are increased.

If a pencil of rays which has passed through a condensing lens be received on a screen placed at *mm* within the focal distance, a bright spot is seen with a red border; if it is placed at *ss* the bright spot has a violet border.

566. **Achromatism.**—By combining prisms which have different refracting angles (530), and are formed of substances of unequal dispersive powers (549) white light may be refracted without being dispersed. The same result is obtained by combining lenses of different substances, the curvatures of which are suitably combined. The images of objects viewed through such lenses do not appear coloured, and they are accordingly called *achromatic* lenses; *achromatism* being the term applied to the phenomenon of the refraction of light without decomposition.

By observing the phenomenon of the dispersion of colours in prisms of water, of oil of turpentine, and of crown glass, Newton was led to suppose that dispersion was proportional to refraction. He concluded that there could be no refraction without dispersion, and, therefore, that achromatism was impossible. Almost half a century elapsed before this was found to be incorrect. Hall, an English philosopher, in 1733, was the first to construct achromatic lenses, but he did not publish his discovery. It is to Dolland, an optician in London, that we owe the greatest improvement which has been made in optical instruments. He showed in 1757 that by combining two lenses, one a double convex crown glass lens, the other a concavo-convex lens of flint glass (fig. 454), a lens is obtained which is virtually achromatic.

To explain this result, let two prisms BFC and CDF, be joined and turned in a contrary direction, as shown in fig. 455. Let us suppose, in the first case, that both prisms are of the same material, but that the refracting angle of the second, CDF, is less than the refracting angle of the first; the two prisms will produce the same effect as a single prism, BAF; that is to say, that white light which traverses it will not only be refracted, but also decomposed. If, on the contrary, the first prism BCF were of crown glass, and the other CFD of flint glass, the dispersion might be destroyed without destroying the refraction. For as flint glass is more dispersive than crown, and as the dispersion produced by a prism diminishes with its refracting angle (549), it follows that by suitably lessening the refracting angle of the flint glass prism CFD, as compared with the refracting angle of the crown glass prism BCF, the dispersive power of these prisms may

be equalised ; and as, from their position, the dispersion takes place in a contrary direction, it is neutralised ; that is, the emergent rays EO are parallel, and therefore give white light. Nevertheless, the ratio of the angles



Fig. 454.



Fig. 455.

BCF and CFD, which is suitable for the parallelism of the red rays and violet rays, is not so for the intermediate rays, and, consequently, only two of the rays of the spectrum can be exactly combined, and the achromatism is not quite perfect. To obtain perfect achromatism, several prisms would be necessary, of unequally dispersive materials, and the angles of which were suitably combined.

The refraction is not destroyed at the same time as the dispersion ; that could only happen if the refracting power of a body varied in the same ratio as its dispersive power, which is not the case. Consequently, the emergent ray EO is not exactly parallel to the incident ray, and there is a refraction without appreciable decomposition.

Achromatic lenses are made of two lenses of unequal dispersive materials ; one, A, of flint glass, is a diverging concavo-convex (fig. 454) ; the other, B, of crown glass, is double convex, and one of its faces may exactly coincide with the concave face of the first. As with prisms, several lenses would be necessary to obtain perfect achromatism ; but for optical instruments two are sufficient, their curvature being such as to combine the blue and orange rays.

## CHAPTER V.

### OPTICAL INSTRUMENTS.

567. **The different kinds of optical instruments.**—By the term *optical instrument* is meant any combination of lenses, or of lenses and mirrors. Optical instruments may be divided into three classes, according to the ends they are intended to answer, viz.:—i. *Microscopes*, which are designed to obtain a magnified image of any object whose real dimensions are too small to admit of its being seen distinctly by the naked eye. ii. *Telescopes*, by which very distant objects, whether celestial or terrestrial, may be observed. iii. *Instruments* designed to project on a screen a magnified or diminished image of any object which can thereby be either depicted or rendered visible to a crowd of spectators ; such as the *camera lucida*, the *camera obscura*, *photographic apparatus*, the *magic lantern*, the *solar microscope*, the *photo-electric microscope*, etc. The two former classes yield virtual images ; the last, with the exception of the *camera lucida*, yield real images.



## MICROSCOPES.

568. **The simple microscope.**—The *simple microscope*, or *magnifying glass* is merely a convex lens of short focal length, by means of which we look at objects placed between the lens and its principal focus. Let  $AB$  (fig. 456) be the object to be observed, placed between the lens and its

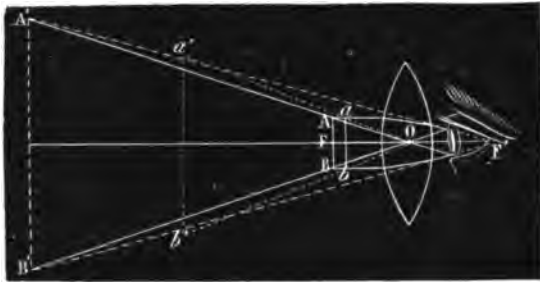

Fig. 456.

principal focus,  $F$ . Draw the secondary axes  $AO$  and  $BO$ , and also from  $A$  and  $B$  rays parallel to the axis of the lens  $FO$ . Now these rays, on passing out of the lens, tend to pass through the second principal focus  $F'$  consequently they are divergent with reference to the secondary axes, and therefore, when produced, will cut those axes in  $A'$  and  $B'$  respectively. These points are the virtual foci of  $A$  and  $B$  respectively. The lens therefore produces at  $A'B'$  an erect and magnified virtual image of the object  $AB$ .

The position and magnitude of this image depend on the distance of the object from the focus. Thus, if  $AB$  is moved to  $ab$  nearer the lens, the secondary axes will contain a greater angle, and the image will be formed at  $a'b'$ , and will be much smaller, and nearer the eye. On the other hand, if the object is moved farther from the lens the angle between the secondary axes is diminished, and their intersection with the prolongation of the refracted rays taking place beyond  $A'B'$ , the image is formed farther from the lens, and is larger.

In a simple microscope both chromatic aberration and spherical aberration increase with the degree of magnification. We have already seen that



Fig. 457.

the former can be corrected by using achromatic lenses (566), and the latter by using diaphragms, which allow the passage of such rays only as are nearly parallel to the axis, the spherical aberration of these rays being nearly inappreciable. Spherical aberration may be still further corrected by using

two plano-convex lenses, instead of one very convergent lens. When this is done, the plane face of each lens is turned towards the object (fig. 457). Although each lens is less convex than the simple lens which together they replace, yet their joint magnifying power is as great, and with a less amount of spherical aberration, since the first lens draws towards the axis the rays which fall on the second lens. This combination of lenses is known as *Wollaston's doublet*.

There are many forms of the simple microscope. One of the best is that represented in fig. 458. On a horizontal support, E, which can be raised and lowered by a rack K and pinion D, there is a black *eyepiece*, *m*, in the centre of which is fitted a small convex lens. Below this is the *stage* *b*, which is fixed, and on which the object is placed between glass plates. In order to illuminate the object powerfully, diffused light is reflected from a concave glass mirror, M, so that the reflected rays fall upon the object. In using this microscope, the eye is placed very near the lens, which is lowered or raised until the position is found at which the object appears in its greatest distinctness.



Fig. 458.

**569. Conditions of distinctness of the images.**—In order that objects looked at through a microscope should be seen with distinctness they must have a strong light thrown upon them, but this is by no means enough. It is necessary that the image be formed at a determinate distance from the eye. In fact, there is for each person a *distance of most distinct vision*—a distance, that is to say, at which an object must be placed from an observer's eye, in order to be seen with greatest distinctness. This distance is different for different observers, but ordinarily is between 10 and 12 inches. It is, therefore, at this distance from the eye that the image ought to be formed. Moreover, this is why each observer has to *focuss* the instrument, that is, to adapt the microscope to his own distance of most distinct vision. This is effected by slightly varying the distance from the lens to the object, for we have seen above that a slight displacement of the object causes a great displacement of the image. With a common magnifying glass, such as is held in the hand, the adjustment is effected by merely moving it nearer to or farther from the object. In the microscope the adjustment is effected by means of a rack and pinion, which in the case of the instrument shown in fig. 458 moves the instrument, but moves the object in the case of the instrument depicted in fig. 462. What has been said about *focussing* the microscope applies equally to telescopes. In the latter instrument the eyepiece is generally adjusted with respect to the image formed in the focus of the object-glass.

**570. Apparent magnitude of an object.**—The apparent magnitude or apparent diameter of a body, is the angle it subtends at the eye of the

observer. Thus, if AB is the object, and O the observer's eye (figs. 459, 460), the apparent magnitude of the object is the angle AOB contained by two visual rays drawn from the centre of the pupil to the extremities of the object.

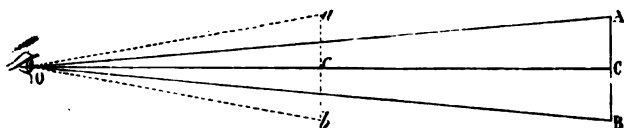

Fig. 459.

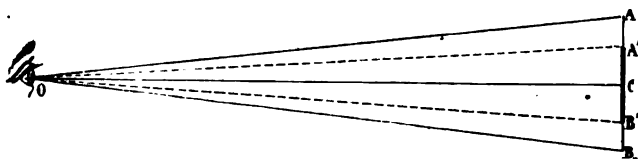

Fig. 460.

In the case of objects seen through optical instruments, the angles which they subtend are so small that the arcs which measure the angles do not differ sensibly from their tangents. The ratio of two such angles is therefore the same as that of their tangents. Hence we deduce the two following principles :—

I. *When the same object is seen at unequal distances, the apparent diameter varies inversely as the distance from the observer's eye.*

II. *In the case of two objects seen at the same distance, the ratio of the apparent diameters is the same as that of their absolute magnitudes.*

These principles may be proved as follows : i. In fig. 459, let AB be the object in its first position, and *ab* the same object in its second position. For the sake of distinctness these are represented in such positions that the line OC passes at right angles through their middle points C and *c* respectively. It is, however, sufficient that *ab* and AB should be the bases of isosceles triangles having a common vertex at O. Now by what has been said above, AB is virtually an arc of a circle described with centre O and radius OC ; likewise *ab* is virtually an arc of a circle whose centre is O and radius Oc. Therefore,

$$AOB : aOb = \frac{AB}{OC} : \frac{ab}{Oc} = \frac{1}{OC} : \frac{1}{Oc}.$$

Therefore, AOB varies inversely as OC.

ii. Let AB and A'B' be two objects placed at the same perpendicular distance, OC, from the eye, O, of the observer (fig. 460). Then they are virtually arcs of a circle whose centre is O and radius OC. Therefore,

$$AOB : A'OB' = \frac{AB}{OC} : \frac{A'B'}{OC} = AB : A'B',$$

a proportion which expresses the second principle.

571. **Measure of magnification.**—In the simple microscope, the measure of the magnification produced, is the ratio of the apparent diameter of the image to that of the object, both being at the distance of most distinct

vision. The same rule holds good for other microscopes. It is, however, important to obtain an expression for the magnification depending on data that are of easier determination.

In fig. 461 let  $AB$  be the object, and  $A'B'$  its image formed at the distance of most distinct vision. Let  $a'b'$  be the projection of  $AB$  on  $A'B'$

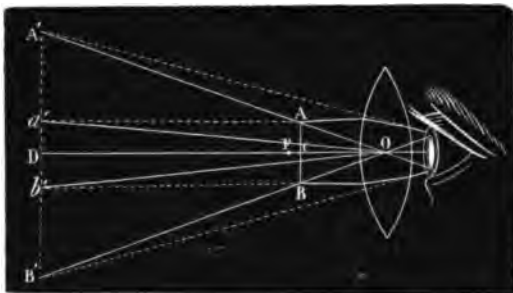

Fig. 461.

Then, since the eye is very near the glass, the magnification equals  $\frac{A'OB'}{a'O'b'}$ , or  $\frac{A'B'}{a'b'}$ , that is,  $\frac{A'B'}{AB}$ . But since the triangles  $A'OB'$  and  $AOB$  are similar,  $A'B' : AB = DO : CO$ . Now  $DO$  is the distance of most distinct vision, and  $CO$  is very nearly equal to  $FO$ , the focal length of the lens. Therefore the magnification equals the ratio of the distance of most distinct vision to the focal length of the lens. Hence we conclude that the magnification is greater:—1st, as the focal length of the lens is smaller, in other words, as the lens is more convergent; 2ndly, as the observer's distance of most distinct vision is greater.

A simpler and more general definition of the measure of magnification may be stated thus—Let  $\alpha$  be the angular magnitude of the object as seen by the naked eye,  $\beta$  the angular magnitude of the image, whether real or virtual, actually present to the eye, then the magnification is  $\beta + \alpha$ . This rule applies to telescopes.

By changing the lens the magnification can be increased, but only within certain limits if we wish to obtain a distinct image. By means of a simple microscope distinct magnification may be obtained up to 120 diameters.

The magnification we have here considered is *linear* magnification. *Superficial* magnification equals the square of the *linear* magnification: for instance, the former will be 1,600 when the latter is 40.

572. **Compound microscope.**—The compound microscope in its simplest form consists of two condensing lenses: one, with a short focus, is called the *object-glass* or *objective*, because it is turned towards the object; the other is less condensing, and is called the *eyepiece* or *power*, because it is close to the observer's eye.

Fig. 462 represents the path of the luminous rays, and the formation of the image in the simplest form of a compound microscope. An object  $AB$ , being placed very near the principal focus of the object-glass,  $M$ , but a little

farther from the glass, a real image,  $ab$ , inverted and somewhat magnified, is formed on the other side of the object-glass (542). Now the distance of the two lenses,  $M$  and  $N$ , is such that the position of the image,  $ab$ , is between the eyepiece,  $N$ , and its focus,  $F$ . From this it follows that for the eye at  $E$ , looking at the image through the eyepiece, this glass produces the same effect as a simple microscope, and instead of this image,  $ab$ , another image,  $a'b'$ , is seen, which is virtual, and still more magnified. This second image, although erect as regards the first, is inverted in reference to the object. It may thus be said, that the compound microscope is nothing,



Fig. 462.

more than a simple microscope applied not to the object, but to its image already magnified by the first lens.

573. **Compound microscope.**—The principle of the compound microscope has been already (572) explained; the principal accessories to the instrument remain to be described.

Fig. 463 represents a perspective view, and fig. 464 a section of a compound microscope. The body of the microscope consists of a series of brass tubes,  $DD'$ ,  $H$ , and  $I$ ; in the former of these is fitted the eyepiece  $O$ , and in the lower part of the latter the object-glass  $o$ . The tube  $I$  moves with gentle friction in the tube  $DD'$ , which in turn can also be moved in a larger tube fixed in the ring  $E$ . This latter is fixed to a piece  $BB'$ , which by means of a very fine screw, worked by the milled head  $T$ , can be moved up and down an inner rod  $c$ , not represented in the figure. The whole body of the microscope is raised and lowered with the piece  $BB'$ , so that it can be placed near or far from the object to be examined. Moreover, the rod  $c$ , and all the other pieces of the apparatus rest on a horizontal axis,  $A$ , with which they turn under so much friction as to remain fixed in any position in which they may be placed.

The objects to be observed are placed between two glass plates,  $V$ , on a stage,  $R$ . This is perforated in the centre so that light can be reflected upon it by a concave reflecting glass mirror,  $M$ . The mirror is mounted on an articulated support, so that it can be placed in any position whatever, so as to reflect to the object either the diffused light of the atmosphere, or that from a candle or lamp. Between the reflector and the stage is a diaphragm or stop,  $K$ , perforated by four holes of different sizes, any one of which can be placed over the perforation in the stage, and thus the light falling on the object may be regulated; the light can, moreover, be regulated by raising, by a lever  $n$ , the diaphragm,  $K$ , which is movable in a slide. Above the diaphragm is a piece,  $m$ , to which can be attached either a very small stop, so that only very little light can reach the object, or a condensing lens, which illuminates it strongly, or an oblique prism, represented at  $X$ .

The rays from the reflector undergo two total reflections in this prism, and emerge by a lenticular face that concentrates them on the object, but in an oblique direction, which in some microscopic observations is an advantage. Objects are generally so transparent that they can be lighted from below; but where, owing to their opacity, this is not possible, they are lighted from above by means of a condensing lens mounted on a jointed support, and so placed that they receive the diffused light of the atmosphere.

Fig. 464 shows the arrangement of the lenses and the path of the rays in the microscope. At  $o$  is the object-glass, consisting of three small condensing lenses, represented on a larger scale at  $L$ , on the right of the figure. The effects of these lenses being added to each other they act like a single

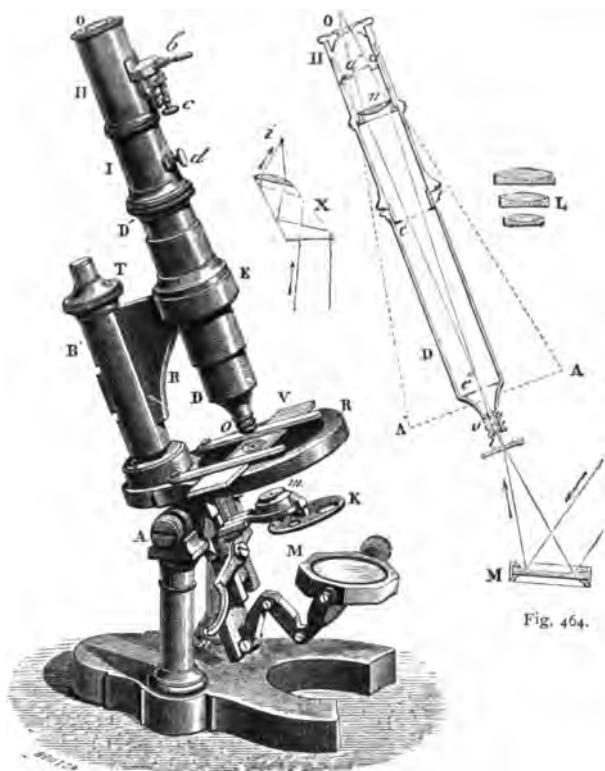

Fig. 464.

Fig. 463.

very powerful condensing lens. The object being placed at  $i$ , a very little beyond the principal focus of the system, the emerging rays fall upon a fourth condensing lens,  $n$ , the use of which will be seen presently (574, 575). Having become more convergent, owing to their passage through the lens,  $n$ , the rays form at  $aa'$  a real and amplified image of the object  $i$ . This

image is between a fifth condensing lens,  $O$ , and the principal focus of this lens. Hence, on looking through this, it acts as a magnifier (542), and gives at  $AA'$ , a virtual and highly magnified image of  $aa'$ , and therefore of the object. The two glasses,  $n$  and  $O$ , constitute the eyepiece in the same manner as the three glasses,  $o$ , constitute the object-glass.

The first image,  $aa'$ , must not merely be formed between the glass,  $O$ , and its principal focus, but at such a distance from this glass that the second image,  $AA'$ , is formed at the observer's distance of distinct vision. This result is obtained in moving, by the hand, the body,  $DH$ , of the microscope in the larger tube fixed to the ring,  $E$ , until a tolerably distinct image is obtained; then turning the milled head,  $T$ , in one direction or the other, the piece,  $BB$ , and with it the whole microscope, are moved until the image  $AA'$ , attains its greatest distinctness, which is the case when the image,  $aa'$ , is formed at the distance of distinct vision: a distance which can always be ultimately obtained, for as the object-glass approaches or recedes from the object, the image,  $aa'$ , recedes from or approaches the eyepiece, and at the same time the image,  $AA'$ .

This operation is called the *focussing*. In the microscope, where the distance from the object-glass to the eyepiece is constant, it is effected by altering their distance from the object. In telescopes, where the objects are inaccessible, the object is effected by varying the distance of the eyepiece and the object glass.

The microscope possesses numerous eyepieces and object-glasses, by means of which a great variety of magnifying power is obtained. A small magnifying power is also obtained by removing one or two of the lenses of the object glass.

The above contains the essential features of the microscope; it is made in a great variety of forms, which differ mainly in the construction of the stand, the arrangement of the lenses, and in the illumination. For descriptions of these, the student is referred to special works on the microscope.

**574. Achromatism of the microscope. Campani's eyepiece.**—When a compound microscope consists of two single lenses, as in fig. 463, not only is the spherical aberration uncorrected, but also the chromatic aberration, the latter defect causing the images to be surrounded by fringes of the prismatic colours, these fringes being larger as the magnification is greater. It is with a view to correcting these aberrations that the object-glass (see fig. 464) is composed of three achromatic lenses, and the eyepiece of two lenses,  $n$  and  $m$ , for the first of these,  $n$ , would be enough to produce colour unless the magnifying power were low.

The effect of this eyepiece in correcting the colour may be explained as follows:—It will be borne in mind that with respect to red rays the focal length of a lens is *greater* than the focal length of the same lens with reference to the violet rays.

In fact, if in the equation (4) (545), we write  $R' = \infty$ , we obtain  $f = \frac{R}{n-1}$ , which gives the focal length of a plano-convex lens whose refractive index is  $n$ . Now, in flint glass, and for the red ray,  $n-1$  equals 0.63, and for the violet ray  $n-1$  equals 0.67.

Let  $ab$  be the object,  $O$  the object-glass which is corrected for colour. Consequently, a pencil of rays falling from  $a$  on  $O$  would converge to a

focus, A, without any separation of colours; but falling on the *field-glass* C, the red rays would converge to  $r$ , the violet rays to  $v$ , and intermediate colours, to intermediate points. In like manner the rays from  $b$ , after passing through the field-glass, would converge to  $r'$ ,  $v'$ , and intermediate points. So that on the whole there would be formed a succession of

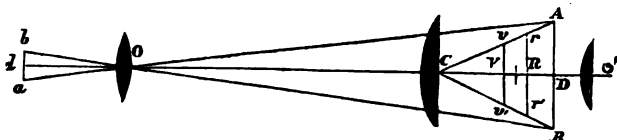

Fig. 465.

coloured images of  $ab$ , viz. a red image at  $rr'$ , a violet image at  $vv'$ , and between them images of intermediate colours. Let  $d$  be the point of the object which is situated on the axis. The rays from  $d$  will converge to R, V, and intermediate points. Now suppose the *eye-glass* O' to be placed in such a manner that R is the principal focus of O' for the red rays, then will V be its principal focus for the violet rays. Consequently, the red rays, after emerging from O', will be parallel to the axis, and so will the violet rays emerging from V, and so of any other colour. Consequently, the colours of  $d$ , which are separated by C, are again combined by O'. The same is very nearly true of  $r$  and  $v$ , and of  $r'$  and  $v'$ . Hence a combination of lenses C and O' corrects the chromatic aberration that would be produced by the use of a single eye-glass. Moreover, by drawing the rays towards the axis, it diminishes the spherical aberration, and, as we shall see in the next article, enlarges the field of view.

In all eyepieces consisting of two lenses the lens to which the eye is applied is called the *eye lens*, the one towards the object-glass is called the *field lens*. The eyepiece above described was invented by Huyghens, who was not, however, aware of its property of achromatism. He designed it for use with the telescope. It was applied to the microscope by Campani. The relation between the focal lengths of the lenses is as follows:—The focal length of the field-glass is three times that of the eye lens, and the distance between their centres is half the sum of the focal length. It easily follows from this that the image of the point  $d$  would, but for the interposition of the field lens, be formed at D, which is so situated that CD is three times DO', then the mean of the coloured images would be formed midway between C and O'.

575. **Field of view.**—By the field of view of an optical instrument is meant all those points which are visible through the eyepiece. The advan-

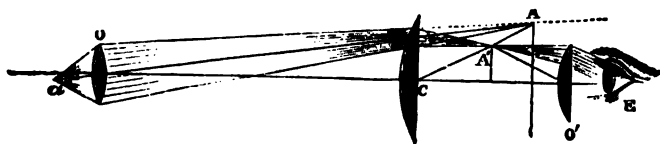

Fig. 466.

tage obtained by the use of an eyepiece in enlarging the field of view will be readily understood by an inspection of the accompanying figure. As before,



O is the object-glass, C the field lens, O' the eye lens, and E the eye placed on the axis of the instrument. Let  $a$  be a point of the object; if we suppose the field lens removed, the pencil of rays from  $a$  would be brought to a focus at A, and none of them would fall on the eye lens O', nor pass into the eye E. Consequently,  $a$  is beyond the field of view. But when the field-glass C is interposed, the pencil of rays is brought to a focus at A', and emerges from O' into the eye. Consequently,  $a$  is now within the field of view. It is in this manner that the substitution of an eyepiece for a single eye lens enlarges the field of view.

576. **Magnifying power. Micrometer.**—The magnifying power of any optical instrument is the ratio of the magnitude of the image to the magnitude of the object. The magnifying power in a compound microscope is the product of the respective magnifying powers of the object-glass and of the eyepiece; that is, if the first of these magnifies 20 times, and the other 10, the total magnifying power is 200. The magnifying power depends on the greater or less convexity of the object-glass and of the eyepiece, as well as on the distance between these two glasses, together with the distance of the object from the object-glass. A magnifying power of 1,500 and even upwards has been obtained; but the image then loses in sharpness what it gains in extent. To obtain precise and well-illuminated images, the magnifying power ought not to exceed 500 to 600 diameters, which gives a superficial enlargement 250,000 to 360,000 times that of the object.

The magnifying power is determined experimentally by means of the *micrometer*; this is a small glass plate, on which by means of a diamond a series of lines is drawn at a distance from each other of  $\frac{1}{10}$  or  $\frac{1}{100}$  of a millimetre. The micrometer is placed in front of the object-glass, and then instead of viewing directly the rays emerging from the eyepiece, O, they are received on a piece of glass, A (fig. 467) inclined at an angle of  $45^\circ$ , and the eye is placed above so as to see the image of the micrometer lines, which is formed by reflection on a screen, E, on which is a scale divided into millimetres. By counting the number of divisions of this scale corresponding to a certain number of lines of the image, the magnifying power may be deduced. Thus, if the image occupies a space of 45 millimetres on the scale and contains 15 lines of the micrometer, the distance between each of which shall be assumed at  $\frac{1}{100}$  millimetre, the absolute magnitude of the object will be  $\frac{15}{100}$  millimetre; and as the image occupies a space of 45 millimetres, the magnification will be the quotient of 45 by  $\frac{15}{100}$  or 300. The eye in this experiment ought to be at such a distance from the screen, E, that the screen is distinctly visible: this distance varies with different observers, but is usually 10 to 12 inches. The magnifying power of the microscope can also be determined by means of the *camera lucida*.

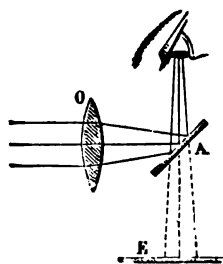

Fig. 467.

When once the magnifying power is known, the absolute magnitude of objects placed before the microscope is easily deduced. For, as the magnifying power is nothing more than the quotient of the size of the image by the size of the object, it

follows that the size of the image divided by the magnifying power gives the size of the object ; it is in this manner that the diameter of all microscopic objects is determined.

## TELESCOPES.

577. **Astronomical telescope.**—The *astronomical telescope* is used for observing the heavenly bodies ; like the microscope, it consists of a condensing eyepiece and object-glass. The object-glass, M (fig. 468), forms be-



Fig. 468.

tween the eyepiece, N, and its principal focus, an inverted image of the heavenly body, and this eyepiece, which acts as a magnifying glass, then gives a virtual and highly magnified image,  $a'b'$ , of the image  $ab$ . The astronomical telescope appears, therefore, analogous to the microscope ; but the two instruments differ in this respect : that in the microscope, the object being very near the object-glass, the image is formed much beyond the principal focus, and is greatly magnified, so that both the object-glass and



Fig. 469

the eyepiece magnify : while in the astronomical telescope, the heavenly body being at a great distance, the incident rays are parallel, and the image formed in the principal focus of the object glass is much smaller than the

object. There is, therefore, no magnification except by the eyepiece, and this ought, therefore, to be of very short focal length.

Fig. 469 shows an astronomical telescope mounted on its stand. Above it there is a small telescope which is called the *finder*. Telescopes with a large magnifying power are not convenient for finding a star, as they have but a small field of view: the position of the star is, accordingly, first sought by the finder, which has a much larger field of view, that is, takes in a far greater extent of the heavens: it is then viewed by means of the telescope.

The magnification (571) equals  $\frac{ACB}{a'Ob}$  (fig. 468); that is, it equals  $\frac{bCO}{bOC}$ , and therefore is approximately equal to  $\frac{CF}{OF}$ , F being the focus of the object-glass, M, and being supposed very nearly to coincide with the focus of the eyepiece, N; it may, therefore, be concluded that the magnifying power is greater in proportion as the object-glass is less convergent, and the eyepiece more so.



Fig. 470.

When the telescope is used to make an accurate observation of the stars, for example, the zenith distance, or their passage over the meridian, a *cross wire* is added. This consists of two very fine metal wires or spider threads stretched across a circular aperture in a small metal plate (fig. 470). The wires ought to be placed in the position where the inverted image is produced by the object-glass, and the point where the wires cross ought to be on the optical axis of the telescope, which thus becomes the *line of sight or collimation*.

578. **Terrestrial telescope.**—The *terrestrial telescope* differs from the astronomical telescope in producing images in their right positions. This is effected by means of two condensing glasses, P and Q (fig. 471), placed

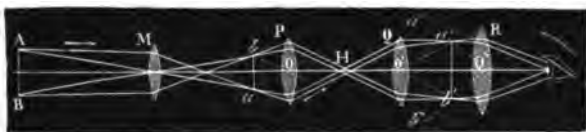

Fig. 471.

between the object-glass, M, and the eyepiece, R. The object being supposed to be at AB, at a greater distance than can be shown in the drawing, an inverted and much smaller image is formed at *ba* on the other side of the object-glass. But the second lens, P, is at such a distance that its principal focus coincides with the image *ab*; from which it follows that the luminous rays which pass through *b*, for example, after traversing the lens, P, take a direction parallel to the secondary axis, *bO* (538). Similarly the rays passing by *a* take a direction parallel to the axis *aO*. After crossing in H, these various rays traverse a third lens Q, whose principal focus coincides with the point H. The pencil *BbH* converges towards *b'*, on a secondary axis *O'b'*, parallel to its direction; the pencil *AaH* converging in the same manner

at  $a'$ , an erect image of the object, AB, is produced at  $a' b'$ . This image is viewed, as in the astronomical telescope, through a condensing eyepiece, R, so placed that it acts as a magnifying glass, that is, its distance from the image,  $a' b'$ , is less than the principal focal distance; hence, there is formed, at  $a'' b''$ , a virtual image of  $a' b'$ , erect, and much magnified. The lenses P and Q, which only serve to rectify the position of the image, are fixed in a brass tube, at a constant distance, which is equal to the sum of their principal focal distances. The object-glass, M, moves in a tube, and can be moved to or from the lens P, so that the image,  $ab$ , is always formed in the focus of the lens whatever be the distance of the object. The distance of the lens, R, may also be varied, so that the image  $a'' b''$  may be formed at the distance of distinct vision.

This instrument may also be used as an astronomical telescope by using a different eyepiece; this must have a much greater magnifying power than in the former case.

In the terrestrial telescope the magnifying power is the same as in the astronomical telescope, provided always that the correcting glasses, P and Q, have the same convexity.

579. **Galileo's telescope.**—*Galileo's Telescope* is the simplest of all telescopes, for it only consists of two lenses, namely, an object glass, M, and

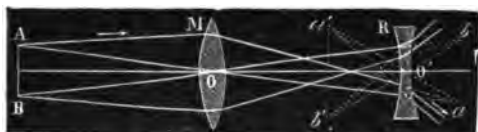

Fig. 472.

a diverging or double concave eyepiece, R (fig. 472), and it gives at once an erect image. *Opera-glasses* are constructed on this principle.

If the object be represented by the right line AB, a real but inverted and smaller image would be formed at  $ba$ ; but in traversing the eyepiece, R, the rays emitted from the points A and B are refracted, and diverge from the secondary axes  $bO'$  and  $aO'$ , which correspond to the points  $b$  and  $a$  of the image. Hence, these rays produced backward meet their axes in  $a'$  and  $b'$ : the eye which receives them sees accordingly an erect and magnified image in  $a' b'$ , which appears nearer because it is seen under an angle,  $a' O' b'$ , greater than the angle, AOB, under which the object is seen.

The magnifying power is equal to the ratio of the angle  $a' O' b'$  to the angle AOB, and is usually from 2 to 4.

The distance of the eyepiece R from the image  $ab$  is pretty nearly equal to the principal focal distance of this eyepiece; it follows, therefore, that the distance between the two lenses is the distance between their respective focal distances; hence, Galileo's telescope is very short and portable. It has the advantage of showing objects in their right position; and, further, as it has only two lenses, it absorbs very little light: in consequence, however, of the divergence of the emergent rays, it has only a small field of view,

and in using it the eye must be placed very near the eyepiece. The eyepiece can be moved to or from the object-glass, so that the image  $a' b'$  is always formed at the distance of distinct vision.

The opera-glass is usually double, so as to produce an image in each eye, by which greater brightness is attained.

The time at which telescopes were invented is not known. Some attribute their invention to Roger Bacon in the 13th century; others to J. B. Porta at the end of the 16th; others again to a Dutchman, Jacques Metius, who, in 1609, accidentally found that by combining two glasses, one concave and the other convex, distant objects appeared nearer and much larger.

Galileo's was the first telescope directed towards the heavens. By its means Galileo discovered the mountains of the moon, Jupiter's satellites, and the spots on the sun.

580. **Reflecting telescopes.**—The telescopes previously described are *refracting* or *dioptric* telescopes. It is, however, only in recent times that it has been possible to construct achromatic lenses of large size; before this, a concave metallic mirror was used instead of the object-glass. Telescopes of this kind are called *reflecting* or *catoptric telescopes*. The principal forms are those devised by Gregory, Newton, Herschel, and Cassegrain.

581. **The Gregorian telescope.**—Figure 473 is a representation of Gregory's telescope; it is mounted on a stand, about which it is movable,



Fig. 473.

and can be inclined at any angle. This mode of mounting is optional; it may be equatorially mounted. Fig. 474 gives a longitudinal section. It consists of a long brass tube closed at one end by a concave metallic mirror, M, which is perforated in the centre by a round aperture through which rays reach the eye. There is a second concave metal mirror, N, near the

end of the tube ; it is somewhat larger than the central aperture in the large mirror, and its radius of curvature is much smaller than that of the large mirror. The axes of both mirrors coincide with the axis of the tube. As the centre of curvature of the large mirror is at  $O$ , and its focus at  $ab$ , rays, such as  $SA$ , emitted from a heavenly body, are reflected from the mirror,  $M$ , and form at  $ab$  an inverted and very small image of the heavenly

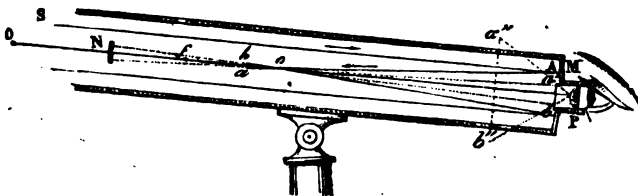

Fig. 474.

body. The distance of the mirrors and their curvatures is so arranged that the position of this image is between the centre,  $o$ , and the focus,  $f$ , of the small mirror ; hence the rays, after being reflected a second time from the mirror  $N$ , form at  $a' b'$  a magnified and inverted image of  $ab$ , and therefore in the true position of the heavenly body. This image is viewed through an eyepiece,  $P$ , which may either be single or compound, its object being to magnify it again so that it is seen at  $a'' b''$ .

As the objects viewed are not always at the same distance, the focus of the large mirror, and therefore that of the small one, vary in position.

And as the distance of distinct vision is not the same with all eyes, the image  $a'' b''$  ought to be formed at different distances. The required adjustments may be obtained by bringing the small mirror nearer or farther from the larger one ; this is effected by means of a milled head,  $A$  (fig. 473), which turns a rod, and this by a screw moves a piece to which the mirror is fixed.

**582. The Newtonian telescope.**—This instrument does not differ much from that of Gregory ; the large mirror is not perforated and there is a small

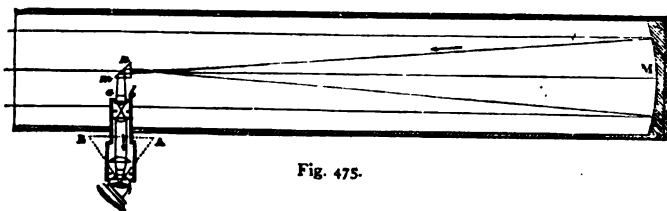

Fig. 475.

plane mirror inclined at an angle of  $45^\circ$  towards an eyepiece placed in the side of the telescope.

The difficulty of constructing metallic mirrors caused telescopes of Gregorian and Newtonian construction to fall into disuse. Of late, however, the process of silvering glass mirrors has been carried to a high state of perfection, and M. Foucault has applied these mirrors to Newtonian telescopes with great success. His first mirror was only four inches

in diameter, but he has successively constructed mirrors of 8, 12, and 13 inches, and at the time of his death had completed one of 32 inches in diameter.

Fig. 476 represents a Newtonian telescope mounted on an equatorial stand, and fig. 475 gives a horizontal section of it. This section shows how

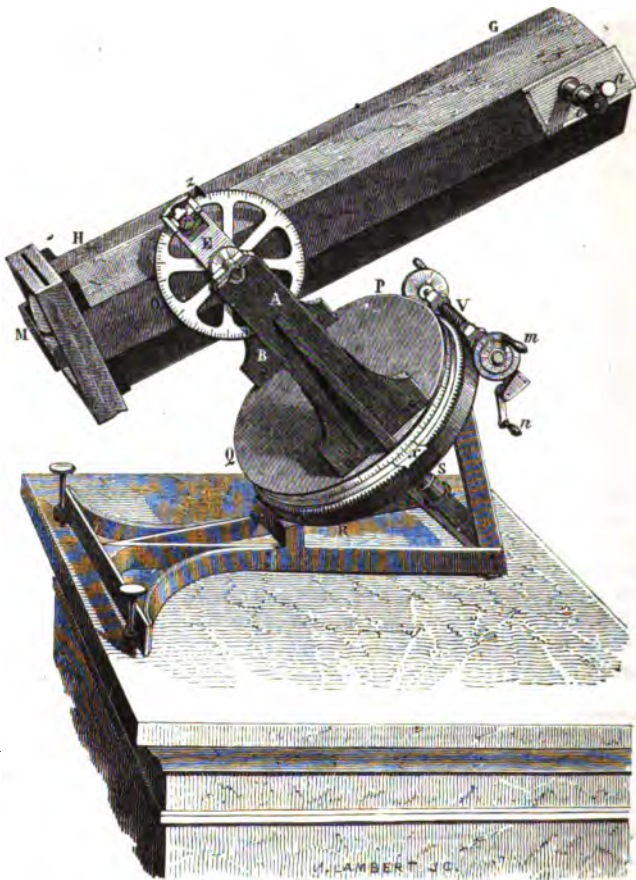

Fig. 476.

the uminous rays reflected from the parabolic mirror, *M*, meet a small rectangular prism, *mn*, which replaces the inclined plane mirror used in the old form of Newtonian telescope. After undergoing a total reflection from *mn*, the rays form at *ab* a very small image of the heavenly body. This image is viewed through an eyepiece with four lenses placed on the side of the telescope, and magnifying from 50 to 800 times, according to the size of the silvered mirror.

In reflectors the mirror acts as object-glass, but there is, of course, no chromatic aberration. The spherical aberration is corrected by the form given to the reflector, which is paraboloid, but slightly modified by trial to suit the eye-piece fitted to the telescope.

The mirror when once polished is immersed in a silvering liquid, which consists essentially of ammoniacal solution of nitrate of silver, to which some reducing agent is added. When a polished glass surface is immersed in this solution, silver is deposited on the surface in the form of a brilliant metallic layer, which adheres so firmly that it can be polished with rouge in the usual manner. These new telescopes with glass mirrors have the advantage over the old ones that they give purer images, they weigh less, and are much shorter, their focal distance being only about six times the diameter of the mirror.

These details known, the whole apparatus remains to be described. The body of the telescope (fig. 476) consists of an octagonal wooden tube. The end G, is open; the mirror is at the other end. At a certain distance from this end, two axles are fixed, which rest on bearings supported by two wooden uprights A and B. These are themselves fixed to a table, PQ, which turns on a fixed plate, RS, placed exactly parallel to the equator. On the circumference of the turning table there is a brass circle divided into 360 degrees, and beneath it, but also fixed to the turning table, there is a circular toothed wheel, in which an endless screw, V, works. By moving this in either direction by means of the handle *m*, the table PQ, and with it the telescope, can be turned. A vernier, *x*, fixed to the plate RS, gives the fractions of a degree. On the axis of the motion of the telescope there is a graduated circle, O, which serves to measure the *declination* of the star, that is, its angular distance from the equator; while the degrees traced round the table, RS, serve to measure the *right ascension*, that is, the angle which the declination circle of the star makes with the declination circle passing through the first point of Aries.

In order to fix the telescope in declination, there is a brass plate, E, fixed to the upright; it is provided with a clamp, in which the limb O works, and which can be screwed tight by means of a screw with a milled head *r*. On the side of the apparatus there is the eyepiece, *o*, which is mounted on a sliding copper plate, on which there is also the small prism *mn*, represented in section in fig. 475. To bring the image to the right place, this plate may be moved by means of a rack and a milled head, *a*. The handle, *n*, serves to *clamp* or *unclamp* the screw, V. The drawing was one taken from a telescope, the mirror of which is only  $6\frac{1}{2}$  inches in diameter, and which gives a magnifying power of 150 to 200.

583. **The Herschelian telescope.**—Sir W. Herschel's telescope, which, until recently, was the most celebrated instrument of modern times, was constructed on a method differing from those described. The mirror was so inclined that the image of the star was formed at *ab* on the side of the telescope near the eyepiece, *o*; hence it is termed the *front view* telescope. As the rays in this telescope only undergo a single reflection, the loss of light is less than in either of the preceding cases, and the image is therefore brighter. The magnifying power is the quotient of the principal focal distance of the mirror by the focal distance of the eyepiece.

Herschel's great telescope was constructed in 1789; it was 40 feet in



length, the great mirror was 50 inches in diameter. The quantity of light obtained by this instrument was so great as to enable its inventor to use magnifying powers far higher than anything which had hitherto been attempted.

Herschel's telescope has been exceeded by one constructed by the late

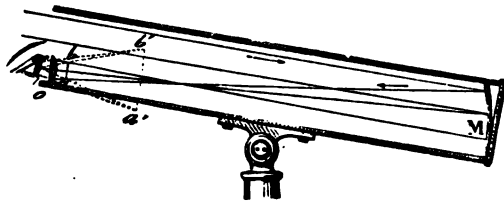

Fig. 477.

Earl of Rosse. This magnificent instrument has a focal distance of 53 feet, the diameter of the spectrum being six feet. It is at present used as a Newtonian telescope, but it can also be arranged as a front view telescope.

#### INSTRUMENTS FOR FORMING PICTURES OF OBJECTS.

584. **Camera obscura.**—The *camera obscura* (dark chamber), is, as its name implies, a closed space impervious to light. There is, however, a small aperture by which luminous rays enter, as shown in fig. 478. The rays, pro-

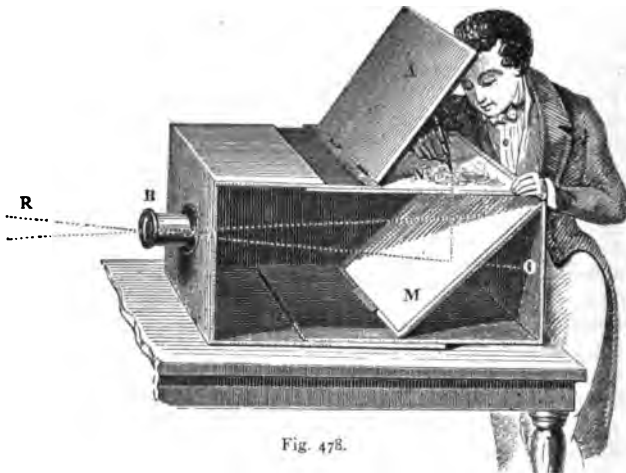

Fig. 478.

ceeding from external objects, and entering by this aperture, form on the opposite side an image of the object in its natural colours, but of reduced dimensions, and in an inverted position.

Porta, a Neapolitan physician, the inventor of this instrument, found that

by fixing a double convex lens in the aperture, and placing a white screen in the focus, the image was much brighter, and more definite.

Fig. 478 represents a camera obscura, such as is used for drawing. It consists of a rectangular wooden box, formed of two parts which slide in and out. The luminous rays, R, pass into the box through a lens B, and form an image on the opposite side, O, which is at the focal distance of the lens. But the rays are reflected from a glass mirror, M, inclined at an angle of  $45^\circ$ , and form an image on the ground-glass plate, N. When a piece of tracing paper is placed on this screen, a drawing of the image is easily made. A wooden door, A, cuts off extraneous light.

The box is formed of two parts, sliding one within the other, like the joints of a telescope, so that, by elongating it more or less, the reflected image may be made to fall exactly on the screen, N, at whatever distance the object may be situated.

Fig. 479 shows another kind of camera obscura, which is occasionally erected in summer houses. In a brass case, A, there is a triangular prism, P (fig. 480), which acts both as condensing lens and as mirror. One of its faces is plane, but the others have such curvatures that the combined refractions on entering and emerging from the prism produce the effect of a meniscus lens. Hence rays from an object, AB, after passing into the prism and undergoing total reflection from the face *cd*, form at *ab* a real image of AB.

In fig. 479, the small table B corresponds to the focus of the prism in the case, A, and an image forms on a piece of paper placed on the table. The whole is surrounded by a black curtain, so that the observer can place himself in complete darkness.

585. **Camera lucida.**—The *camera lucida* is a small instrument depending on internal reflection, and serves for taking an outline of any object. It was invented by Dr. Wollaston in 1804. It consists of a small four-sided glass prism, of which fig. 481 gives a section perpendicular to the edges. A is a right angle, and C an angle of  $135^\circ$ ; the other angles, B and D, are  $67\frac{1}{2}^\circ$ . The prism rests on a stand, on which it can be raised or lowered, and turned more or less about an axis parallel to the prismatic edges. When the face, AB, is turned towards the object, the rays from the object fall nearly perpendicular on this face, pass into the prism without any appreciable refraction, and are totally reflected from BC; for as the line *ab* is perpendicular to



Fig. 479.

BC, and  $nL$  to AB, the angle  $anL$  will equal the angle B—that is, it will contain  $67\frac{1}{2}^\circ$ , and this being greater than the critical angle of glass (526), the ray

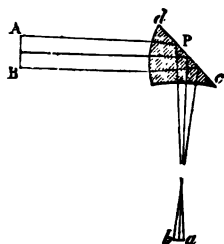

Fig. 48o.

$Ln$  will undergo total reflection. The rays are again totally reflected from  $o$ , and emerge near the summit, D, in a direction almost perpendicular to the face DA, so that the eye which receives the rays sees at  $L'$  an image of the object L. If the outlines of the image are traced with a pencil, a very correct design is obtained; but unfortunately there is a great difficulty in seeing both the image and the point of the pencil, for the rays from the object give an image which is farther from the eye than the pencil. This is corrected by placing between the eye and prism a lens, I, which gives to the rays from the pencil and those from the object the same divergence. In this case, however, it is necessary to place the eye very near the edge of the prism, so that the aperture of the pupil is divided into two parts, one of which sees the image and the other the pencil.

Amici's camera lucida, represented in fig. 482, is preferable to that of Wollaston; inasmuch as it allows the eye to change its position to a con-

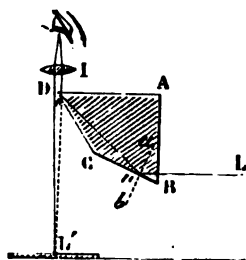

Fig. 48r.

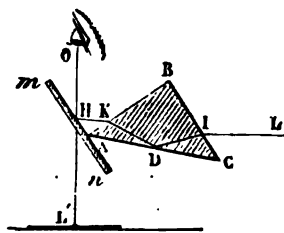

Fig. 482.

siderable extent, without ceasing to see the image and the pencil at the same time. It consists of a rectangular glass prism, ABC, having one of its perpendicular faces turned towards the object to be depicted, while the other is at right angles to an inclined plate of glass,  $mn$ . The rays, LI, proceeding from the object, and entering the prism, are totally reflected from its base at D, and emerge in the direction KH. They are then partially reflected from the glass plate  $mn$  at H, and form a vertical image of the object, L, which is seen by the eye in the direction  $OL'$ . The eye at the same time sees through the glass the point of the pencil applied to the paper, and thus the outline of the picture may be traced with great exactness.

586. **Magic lantern.**—This is an apparatus by which a magnified image of small objects may be projected on a white screen in a dark room. It consists of a tin plate box, in which there is a lamp placed in the focus of a concave mirror, A (fig. 484). The reflected rays fall upon a condensing lens, B,

(fig. 483), which concentrates them on the figure painted on a glass plate, V. There is a double convex lens, C, at a distance from V of rather more than its focal distance, and, consequently, a real and very much magnified image of the figure on the glass is produced on the screen (542).

*Dissolving views* are obtained by arranging two magic lanterns, which are quite alike, with different pictures, in such a manner that both pictures

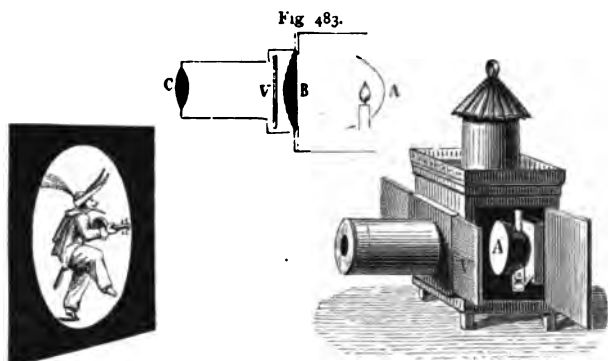

Fig. 484.

are produced on exactly the same part of a screen. The object glasses of both lanterns are closed by shades, which are so arranged that according as one is raised the other is lowered, and *vice versa*. In this way one picture is gradually seen to change into the other.

The magnifying power of the magic lantern is obtained by dividing the distance of the lens C from the image by its distance from the object. If the image is 100 or 1,000 times farther from the lens than the object, the image will be 100 or 1,000 times as large. Hence a lens with a very short focus can produce a very large image, provided the screen is sufficiently large.

587. **Solar microscope.**—The solar microscope is in reality a magic lantern illuminated by the sun's rays; it serves to produce highly magnified images of very small objects. It is worked in a dark room; fig. 485 represents it fitted in the shutter of a room, and fig. 486 gives the internal details.

The sun's rays fall on a plane mirror, M, placed outside the room, and are reflected towards a condensing lens, *l*, and from thence to a second lens, *o* (fig. 486), by which they are concentrated at its focus. The object to be magnified is at this point; it is placed between two glass plates, which, by means of a spring, *n*, are kept in a firm position between two metal plates, *m*. The object thus strongly illuminated is very near the focus of a system of three condensing lenses, *x*, which forms upon a screen at a suitable distance an inverted and greatly magnified image, *ab*. The distance of the lenses, *o* and *x*, from the object is regulated by means of screws, C and D.

As the direction of the sun's light is continually varying, the position of the mirror outside the shutter must also be changed, so that the reflection is always in the direction of the axis of the microscope. The most exact

àpparatus for this purpose is the heliostat (520) ; but as this instrument is very expensive, the object is usually attained by inclining the mirror to a greater or less extent by means of an endless screw B, and at the same time

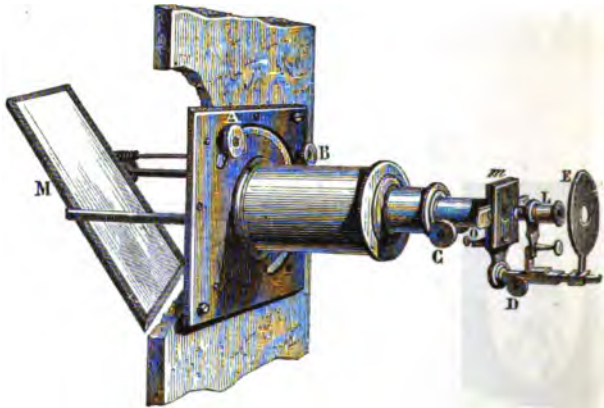

Fig. 485.

turning the mirror itself round the lens, *l*, by a knob, *A*, which moves in a fixed slide.

The solar microscope labours under the objection of concentrating great heat on the object, which soon alters it. This is partially obviated by interposing a layer of a saturated solution of alum, which, being a powerfully athermanous substance (422), cuts off a considerable portion of the heat.

The magnifying power of the solar microscope may be deduced experimentally by substituting for the object a glass plate marked with lines at a

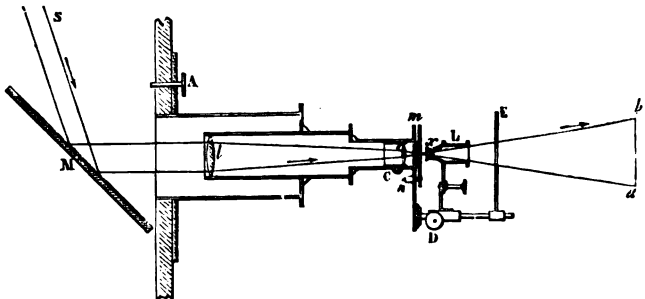

Fig. 486.

distance of  $\frac{1}{10}$  or  $\frac{1}{100}$  of a millimetre. Knowing the distance of these lines on the image, the magnifying power may be calculated. The same method is used with the photo-electric light. According to the magnifying power which

it is desired to obtain, the objective  $x$  is formed of one, two, or three lenses, which are all achromatic.

The solar microscope furnishes the means of exhibiting to a large audience many curious phenomena, such, for instance, as the circulation of blood in the smaller animals, the crystallisation of salts, the occurrence of animalculæ in water, vinegar, etc. etc.

588. **Photo-electric microscope.**—This is nothing more than the solar microscope, which is illuminated by the electric light instead of by the sun's rays. The electric light, by its intensity, its steadiness, and the readi-

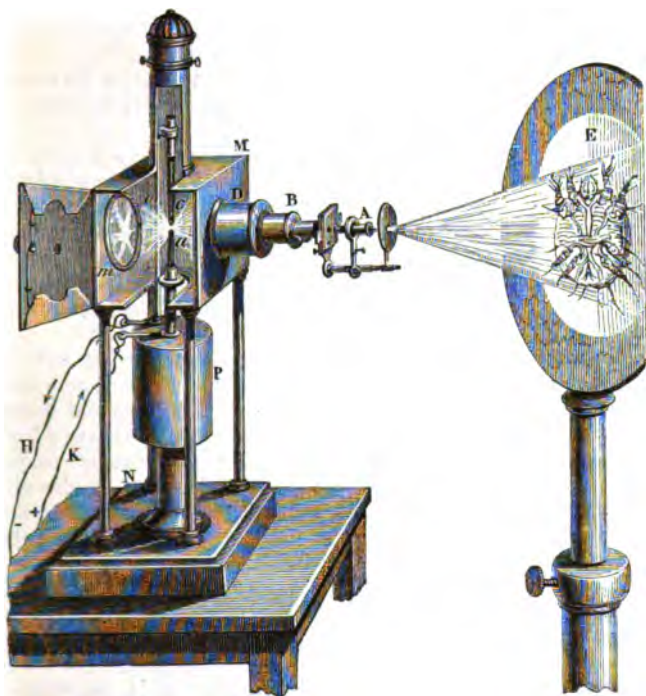

Fig. 487.

ness with which it can be procured at any time of the day, is far preferable to the solar light. The photo-electric microscope alone will be described here: the electric light will be considered under the head of Galvanism.

Fig. 487 represents the arrangement devised by M. Duboscq. A solar microscope, ABD, identical with that already described, is fixed on the outside of a brass box. In the interior are two charcoal points which do not quite touch, the space between them being exactly on the axis of the lenses. The electricity of one end of a powerful battery reaches the charcoal,  $a$ , by means of a copper wire, K; while the electricity from the opposite end of the battery reaches  $c$  by a second copper wire H.

During the passage of the electricity, a luminous arc is formed between the two ends of the carbons, which gives a most brilliant light, and powerfully illuminates the microscope. This is effected by placing at D in the inside of the tube a condensing lens, whose principal focus corresponds to the space between the two charcoals. In this manner the luminous rays, which enter the tubes, D and B, are parallel to their axis, and the same effects are produced as with the ordinary solar microscope; a magnified image of the object placed between two plates of glass is produced on the screen.

In continuing the experiment, the two carbons become consumed, and to an unequal extent, *a* more quickly than *c*. Hence, their distance increasing, the light becomes weaker, and is ultimately extinguished. In speaking afterwards of the electric light, the working of the apparatus, P, which keeps these charcoals at a constant distance, and thus ensures a constant light, will be explained.

The part of the apparatus, MN, may be considered as a universal *photo-genic apparatus*. The microscope can be replaced by the head-pieces of the phantasmagoria, the polyorama, the megascope, by polarising apparatus, etc., and in this manner is admirably adapted for exhibiting optical phenomena to a large auditory. Instead of the electric light, we may use with this apparatus the *oxy-hydrogen* or *Drummond's* light, which is obtained by heating a cylinder of lime in the flame produced by the combustion of a mixture of hydrogen or of coal gas with oxygen gas.

589. **Lighthouse lenses.**—Lenses of large dimensions are very difficult of construction; they further produce a considerable spherical aberration, and their thickness causes the loss of much light. In order to avoid these inconveniences, *echelon* lenses have been constructed. They consist of a plano-convex lens, C (figs. 488 and 489), surrounded by a series of annular and concentric segments, A, B, each of which has a plane face on the same side as the plane face of the central lens, while the faces on the other side have such a curvature that the foci of the different segments coincide in the same point. These rings form, together with the central lens, a single lens, a section of which is represented in fig. 489. The drawing was made from a lens of about 2 feet in diameter, the segments of which are formed of a single piece of glass; but with larger lenses, each segment is likewise formed of several pieces.

Behind the lens there is a support fixed by three rods, on which a body can be placed and submitted to the sun's rays. As the centre of the support coincides with the focus of the lens, the substances placed there are melted and volatilised by the high temperature produced. Gold, platinum, and quartz are melted. The experiment proves that heat is refracted in the same way as light: for the position of the calorific focus is identical with that of the luminous focus.

Formerly parabolic mirrors were used in sending the light of beacons and lighthouses to great distances, but they have been supplanted by the use of lenses of the above construction. In most cases, oil is used in a lamp of peculiar construction, which gives as much light as 20 moderators. The light is placed in the principal focus of the lens so that the emergent rays form a parallel beam (fig. 428), which loses intensity only by passing through

the atmosphere, and can be seen at a distance of above 40 miles. In order that all points of the horizon may be successively illuminated, the lens is continually moved round the lamp by a clockwork motion, the rate of which varies with different lighthouses. Hence, in different parts, the light alternately appears and disappears after equal intervals of time. These alternations serve to distinguish lighthouses from an accidental fire or a star. By means, too, of the number of times the light disappears in a given time, and by the colour of the light, sailors are enabled

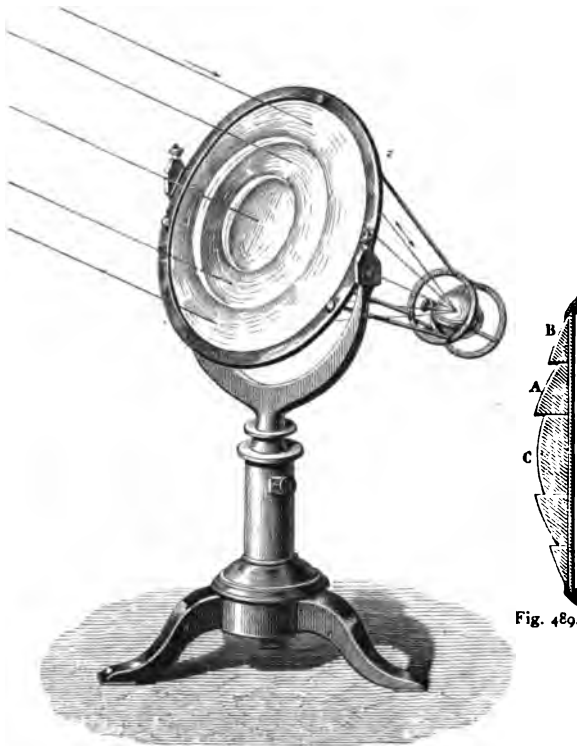

Fig. 488.

Fig. 489.

to distinguish the lighthouses from one another, and hence to know their position.

Of late years the use of the electric light has been substituted for that of oil lamps; a description of the apparatus will be given in a subsequent chapter.

#### PHOTOGRAPHY.

590. **Daguerreotype.**—*Photography* is the art of fixing the images of the camera obscura on substances *sensitive* to light. The various photographic



processes may be classed under three heads : photography on metal, photography on paper, and photography on glass.

Wedgwood was the first to suggest the use of chloride of silver in fixing the image, and Davy, by means of the solar microscope, obtained images of small objects on paper impregnated with chloride of silver ; but no method was known of preserving the images thus obtained, by preventing the further action of light. Niepce, in 1814, obtained permanent images of the camera by coating glass plates with a layer of a varnish composed of bitumen dissolved in oil of lavender. This process was tedious and inefficient, and it was not until 1839 that the problem was solved. In that year, Daguerre described a method of fixing the images of the camera, which, with the subsequent improvements of Talbot and Archer, has rendered the art of photography one of the most marvellous discoveries ever made, either as to the beauty and perfection of the results, or as to the celerity with which they are produced.

In Daguerre's process, the *Daguerreotype*, the picture is produced on a plate of copper coated with silver. This is first very carefully polished, an operation on which much of the success of the subsequent operations depends. It is then rendered *sensitive* by exposing it to the action of iodine vapour, which forms a thin layer of iodide of silver on the surface. The plate is now fit to be exposed in the camera ; it is sensitive enough for views which require an exposure of ten minutes in the camera, but when greater rapidity is required, as for portraits, etc., it is further exposed to the action of an *accelerator*, such as bromine or hypobromite of calcium. All the operations must be performed in a room lighted by a candle, or by the daylight admitted through yellow glass, which cuts off all chemical rays. The plate is preserved from the action of light by placing it in a small wooden case provided with a slide on the sensitive side.

The third operation consists in exposing the sensitive plate to the action of light, placing it in that position in the camera where the image is produced



Fig. 490.

with greatest delicacy. For photographic purposes a camera obscura of peculiar construction is used. The brass tube A (fig. 490), contains an

achromatic condensing lens, which can be moved by means of a rackwork motion, to which is fitted a milled head, D. At the opposite end of the box is a ground-glass plate, E, which slides in a groove, B, in which the case containing the plate also fits. The camera being placed in a proper position before the object, the sliding part of the box is adjusted until the image is produced on the glass with the utmost sharpness; this is the case when the glass slide is exactly in the focus. The final adjustment is made by means of the milled head, D.

The glass slide is then replaced by the case containing the sensitive plate; the slide which protects it is raised; and the plate exposed for a time, the duration of which varies in different cases, and can only be hit exactly by great practice. The plate is then removed to a dark room. No change is perceptible to the eye, but those parts on which the light has acted have acquired the property of condensing mercury: the plate is next placed in a box and exposed to the action of mercurial vapour at 60 or 70 degrees.

The mercury is deposited on the parts affected, in the form of globules imperceptible to the naked eye. The shadows, or those parts on which the light has not acted, remain covered with the layer of iodide of silver. This is removed by treatment with hyposulphite of sodium, which dissolves iodide of silver without affecting the rest of the plate. The plate is next immersed in a solution of chloride of gold in hyposulphite of sodium, which dissolves the silver, while some gold combines with the mercury and silver of the parts attacked, and greatly increases the intensity of the lustre.

Hence the light parts of the image are those on which the mercury has been deposited, and the shaded those on which the metal has retained its reflecting lustre.

Fig. 491 represents a section of the camera and the object-glass. At first it consisted of a double convex lens, but now double achromatic lenses, LL',

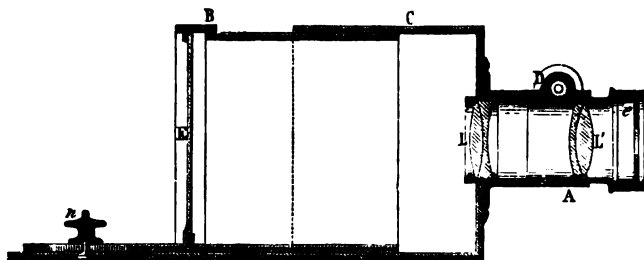

Fig. 491.

are used as object-glasses. They act more quickly than objectives with a single lens, have a shorter focus, and can be more easily focussed by moving the lens, L', by means of the rack and pinion, D.

591. **Photographs on paper.**—In Daguerre's process, which has just been described, the images are produced directly on metal plates. With paper and glass, photographs of two kinds may be obtained: those in which an image is obtained with reversed tints, so that the lightest parts have be-

come the darkest on paper, and *vice versa*; and those in which the lights and shades are in their natural position. The former are called *negative* and the latter *positive* pictures.

A negative may be taken either on glass or on paper; it serves to produce a positive picture.

**Negatives on glass.**—A glass plate of the proper size is carefully cleaned, and coated with a uniformly thick layer of collodion impregnated with iodide of potassium. The plate is then immersed for about a minute in a bath of nitrate of silver containing 30 grains of the salt in an ounce of water. This operation must be performed in a dark room. The plate is then removed, allowed to drain, and when somewhat dry, placed in a closed frame, and afterwards exposed in the camera, for a shorter time than in the case of a Daguerreotype. On removing the plate to a dark room, no change is visible, but on pouring over it a solution called the *developer*, an image gradually appears. The principal substances used for developing are protosulphate of iron and pyrogallic acid. The action of light on iodide of silver appears to produce some molecular change, or else some actual chemical decomposition, in virtue of which the developers have the property of reducing to the metallic state those parts of the iodide of silver which have been most acted upon by the light. When the picture is sufficiently brought out, water is poured over the plate, in order to prevent the further action of the developer. The parts on which light has not acted are still covered with iodide of silver, which would be affected if the plate were now exposed to the light. It is, accordingly, washed with solution of hyposulphite of sodium, which dissolves the iodide of silver and leaves the image unaltered. The picture is then coated with a thin layer of spirit-varnish, to protect it from mechanical injury.

When once the negative is obtained, it may be used for printing an indefinite number of positive pictures. For this purpose paper is impregnated with chloride of silver, by immersing it first in solution of nitrate of silver and then in one of chloride of sodium; chloride of silver is thus formed on the paper by double decomposition. The negative is placed on a sheet of this paper in a copying frame, and exposed to the action of light for a certain time. The chloride of silver becomes acted upon—the light parts of the negative being most affected, and the dark parts least so. A copy is thus obtained, on which the lights of the negative are replaced by shades, and inversely. In order to fix the picture, it is washed in a solution of hyposulphite of sodium, which dissolves the unaltered chloride of silver. The picture is afterwards immersed in a bath of chloride of gold which gives it tone.

**592. Positives on glass.**—Very beautiful positives are obtained by preparing the plates as in the preceding cases; the exposure in the camera, however, is not nearly so long as for the negatives. The picture is then developed by pouring over it a solution of protosulphate of iron, which produces a negative image, and by afterwards pouring a solution of cyanide of potassium over the plate, this negative is rapidly converted into a positive. It is then washed and dried, and a coating of varnish poured over the picture.

**593. Photographs on albumenised paper and glass.**—In some cases, paper impregnated with a solution of albumen containing iodide of potassium

is used instead of collodion, over which it has the advantage that it can be prepared for some time before it is used, and that it produces certain effects in the middle tints. It has the disadvantage of not being nearly so sensitive. It requires, therefore, longer exposure, and is unsuitable for portraits, but can be advantageously used for views.

## CHAPTER VI.

### THE EYE CONSIDERED AS AN OPTICAL INSTRUMENT.

594. **Structure of the human eye.**—The *eye* is the organ of *vision*—that is to say, of the phenomenon by virtue of which the light emitted or reflected from bodies excites in us the sensation which reveals their presence.

The eye is placed in a bony cavity called the orbit; it is maintained in its position by the muscles which serve to move it, by the optic nerve, the conjunctiva, and the eyelids. Its size is much the same in all persons: it is the varying aperture of the eyelids that makes the eye appear larger or smaller.

Fig. 492 represents a transverse section of the eye from back to front. The general shape is that of a spheroid, the curvature of which is greater

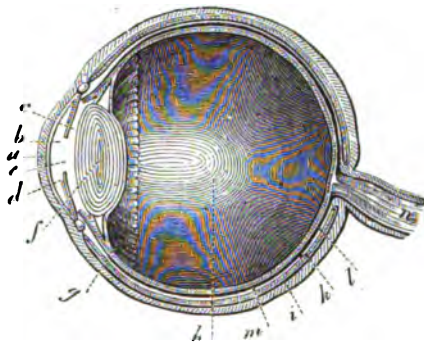

Fig. 492.

in the anterior than in the posterior part. It is composed of the following parts: the *cornea*, the *sclerotica*, the *iris*, the *pupil*, the *aqueous humour*, the *crystalline*, the *vitreous body*, the *hyaloid membrane*, the *choroid*, the *retina*, and the *optic nerve*.

**Cornea.**—The cornea, *a*, is a transparent membrane situated in front of the ball of the eye. In shape it resembles a small watch glass, and it fits into the sclerotica, *i*; in fact, these membranes are so connected that some anatomists have considered them as one and the same, and have distinguished them by calling the cornea the *transparent*, and the sclerotica the *opaque cornea*.

**Sclerotica.**—The sclerotica, *i*, or *sclerotic coat*, is a membrane which,

together with the cornea, envelopes all parts of the eye. In front there is an almost circular aperture into which the cornea fits; a perforation behind gives passage to the optic nerve.

*Iris.*—The iris, *d*, is an annular, opaque diaphragm, placed between the cornea and the crystalline lens. It constitutes the coloured part of the eye, and is perforated by an aperture called the *pupil*, which in man is circular. In some animals, especially those belonging to the genus *felis*, it is narrow and elongated in a vertical direction; in the ruminants it is elongated in a transverse direction. It is a contractile membrane, and its diameter varies in the same individual between 0·12 and 0·28 of an inch; but these limits may be exceeded. The luminous rays pass into the eye through the pupil. The pupil enlarges in darkness, but contracts under the influence of a bright light. These alterations of contraction and enlargement take place with extreme rapidity; they are very frequent, and play an important part in the act of vision. The movements of the iris are involuntary.

It appears from this description that the iris is a screen with a variable aperture, whose function is to regulate the quantity of light which penetrates into the eye; for the size of the pupil diminishes as the intensity of light increases. The iris serves also to correct the spherical aberration, as it prevents the marginal rays from passing through the edges of the crystalline lens. It thus plays the same part with reference to the eye that a diaphragm does in optical instruments (544).

*Aqueous humour.*—Between the posterior part of the cornea and the front of the crystalline there is a transparent liquid called the aqueous humour. The space, *e*, occupied by this humour is divided into two parts by the iris; the part *b*, between the cornea and the iris, is called the *anterior chamber*; the part *c*, which is between the iris and the crystalline, is the *posterior chamber*.

*Crystalline lens.*—This is a double convex transparent body placed immediately behind the iris; the inner margin of which is in contact with its anterior surface, though not attached to it. The lens is enclosed in a transparent membrane, called its *capsule*; it is less convex on its anterior than on its posterior surface, and is composed of almost concentric layers, which decrease in density and refracting power from the centre to the circumference.

To the anterior surface of the capsule, near its margin, is fixed a firm transparent membrane, which is attached behind to the front of the hyaloid membrane, and is known as the *suspensory ligament*. This ligament exerts a traction, all round, on the front surface of the lens, and renders it less convex than it would otherwise be, and its relaxation plays an important part in the adaptation of the eye for sight at different distances.

*Vitreous body. Hyaloid membrane.*—The vitreous body, or vitreous humour, is a transparent mass resembling the white of an egg, which occupies all the part of the ball of the eye *h*, behind the crystalline. The vitreous humour is surrounded by the *hyaloid membrane*, *l*, which lines the posterior face of the crystalline capsule, and also the interior face of another membrane called the retina.

*Retina. Optic nerve.*—The retina, *m*, is a membrane which receives the impression of light, and transmits it to the brain by the intervention of a

nerve, *n*, called the optic nerve, which, proceeding from the brain, penetrates into the eye, and extends over the retina in the form of a nervous network. The nerve-fibres themselves are not sensitive to light, but are only stimulated by it indirectly through the intervention of certain structures called the *rods and cones*. Where the optic nerve enters, there are no rods or cones; this part of the retina therefore is insensitive to light and is called the *punctum cæcum*.

The only property of the retina and optic nerve is that of receiving and transmitting to the brain the impression of objects. These organs have been cut and pricked without causing any pain to the animals submitted to these experiments; but there is reason to believe that irritation of the optic nerve causes the sensation of a flash of light.

*Choroid*.—The choroid, *k*, is a membrane between the retina and the sclerotica. It is completely vascular, and is covered on the internal face by a black substance which resembles the colouring matter of a negro's skin, and which absorbs all rays not intended to co-operate in producing vision.

The choroid elongates in front, and forms a series of convoluted folds, called *ciliary processes*, which penetrate between the iris and the crystalline capsule, to which they adhere, forming round it a disc, resembling a radiated flower. By its vascular tissue, the choroid serves to carry the blood into the interior of the eye, and especially to the ciliary processes.

595. **Refractive indices of the transparent media of the eye.**—The refractive indices from air into the transparent parts of the eye have been determined by Brewster. His results are contained in the following table, compared with water as a standard:—

Water . . . . .	1'3358
Aqueous humour . . . . .	1'3366
Vitreous humour . . . . .	1'3394
Exterior coating of the crystalline . . . . .	1'3767
Centre of the crystalline . . . . .	1'3990
Mean refraction of the crystalline . . . . .	1'3839

596. **Curvatures and dimensions of various parts of the human eye.**

Radius of curvature of the sclerotica . . . . .	0'40 to 0'44 in.
"    "    cornea . . . . .	0'28 to 0'32 "
"    "    anterior face of the crystalline . . . . .	0'28 to 0'40 "
"    "    posterior face " . . . . .	0'20 to 0'24 "
Diameter of the iris . . . . .	0'44 to 0'48 "
"    "    pupil . . . . .	0'12 to 0'28 "
"    "    crystalline . . . . .	0'40 "
Thickness of the crystalline . . . . .	0'20 "
Distance from the pupil to the cornea . . . . .	0'08 "
Length of the axis of the eye . . . . .	0'88 to 0'96 "

597. **Path of rays in the eye.**—From what has been said as to the structure of the eye it may be compared to a camera obscura (584), of which the pupil is the aperture, the crystalline is the condensing lens, and the

retina is the screen on which the image is formed. Hence, the effect is the same as when the image of an object placed in front of a double convex lens is formed in its conjugate focus. Let AB (fig. 493) be an object placed before the eye, and let us consider the rays emitted from any point of the



Fig. 493.

object, A. Of all these rays those which are directed towards the pupil are the only ones which penetrate the eye, and are operative in producing vision. These rays, on passing into the aqueous humour, experience a first refraction which brings them near the secondary axis *Aa*, drawn through the optic centre of the crystalline; they then traverse the crystalline, which again refracts them like a double convex lens, and having experienced a final refraction by the vitreous humour, they meet in a point, *a*, and form the image of the point, A. The rays issuing from the point B form in like manner an image of it at the point *b*, so that a very small, real, and inverted image is formed exactly on the retina, provided the eye is in its normal condition.

598. **Inversion of images.**—In order to show that the images formed on the retina are really inverted, the eye of an albino or any animal with pink eyes may be taken; this has the advantage that, as the choroid is destitute of pigment, light can traverse it without loss. This is then deprived at its posterior part of the cellular tissue surrounding it, and fixed in a hole in the shutter of a dark room; by means of a lens it may be seen that the inverted images of external objects are depicted on the retina.

The inversion of images in the eye has greatly occupied both physicists and physiologists, and many theories have been proposed to explain how it is that we do not see inverted images of objects. The chief difficulty seems to have arisen from the conception of the mind or brain as something behind the eye looking into it and seeing the image upon the retina; whereas really this image simply causes a stimulation of the optic nerve, which produces some molecular change in some part of the brain, and it is only of this change, and not of the image, as such, that we have any consciousness. The mind has thus no direct cognisance of the image upon the retina, nor of the relative positions of its parts, and, sight being supplemented by touch in innumerable cases, it learns from the first to associate the sensations brought about by the stimulation of the retina (although due to an inverted image) with the correct position of the object as taught by touch.

599. **Optic axis, optic angle, visual angle.**—The *principal optic axis* of an eye is the axis of its figure; that is to say, the straight line in reference to which it is symmetrical. In a well-shaped eye it is the straight line

passing through the centre of the pupil and of the crystalline, such as the line  $Oo$  (fig. 493). The lines  $Aa$ ,  $Bb$ , which are almost rectilinear, are secondary axes. The eye sees objects most distinctly in the direction of the principal optic axis.

The *optic angle* is the angle  $BAC$  (fig. 494), formed between the principal optic axis of the two eyes when they are directed towards the

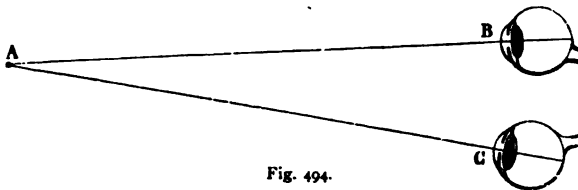

Fig. 494.

same point. This angle is smaller in proportion as the objects are more distant.

The *visual angle* is the angle  $AOB$  (fig. 495), under which an object is seen; that is to say, the angle formed by the secondary axes drawn from the optic centre of the crystalline to the opposite extremities of the object. For the same distance, this angle increases with the magnitude of the

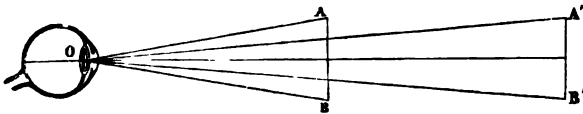

Fig. 495.

object, and for the same object it decreases as the distance increases, as is the case when the object passes from  $AB$  to  $A'B'$ . It follows, therefore, that objects appear smaller in proportion as they are more distant; for as the secondary axes,  $AO$ ,  $BO$ , cross in the centre of the crystalline, the size of the image projected on the retina depends on the size of the visual angle,  $AOB$ .

**600. Estimation of the distance and size of objects.**—The estimation of distance and of size depends on numerous circumstances; these are—the visual angle, the optic angle, the comparison with objects whose size is familiar to us, the diminution of the precision of the image by the interposition of a more or less vaporous medium.

When the size of an object is known, as the figure of a man, the height of a tree or of a house, the distance is estimated by the magnitude of the visual angle under which it is seen. If its size is unknown, it is judged relatively to that of objects which surround it.

A colonnade, an avenue of trees, the gas-lights on the side of a road, appear to diminish in size in proportion as their distance increases, because the visual angle decreases; but the habit of seeing the columns, trees, etc., in their proper height, leads our judgment to rectify the impression produced by vision. Similarly, although distant mountains are seen under a very



small angle, and occupy but a small space in the field of view, our familiarity with the effects of aerial perspective enables us to form a correct idea of their real magnitude.

The optic angle is also an essential element in appreciating distance. This angle increasing or diminishing according as objects approach or recede, we move our eyes so as to make their optic axes converge towards the object which we are looking at, and thus obtain an idea of its distance. Nevertheless, it is only by long custom that we can establish a relation between our distance from the objects and the corresponding motion of the eyes. It is a curious fact that persons born blind, and whose sight has been restored by the operation for cataract, imagine at first that all objects are at the same distance.

Vertical distances are estimated too low compared with horizontal ones ; on high mountains and over large surfaces of water, distances are estimated too low owing to the want of intervening objects.

We cannot recognise the true form of an object if the visual angle is less than half a minute. A white square, a metre in the side, appears at a distance of about 5 miles under this angle as a bright spot which can scarcely be distinguished from a circle of the same size.

601. **Distance of distinct vision.**—The *distance of distinct vision* is, as already stated, the distance at which objects must be placed so as to be seen with the greatest distinctness. It varies in different individuals, and in the same individual it is often different in the two eyes. For small objects, such as print, it is from 10 to 12 inches in normal cases.

In order to obtain an approximate measurement of the least distance of distinct vision, two small parallel slits are made in a card at a distance of 0·03 of an inch. These apertures are held close before the eye, and when a fine slit in another card is held very near these apertures, the slit is seen double, because the rays of light which have traversed both apertures do not intersect each other on the retina, but behind it. But, if the latter card is gradually removed, the distance is ultimately reached at which both images coincide and form one distinct image. This is the distance of distinct vision. Stampfer has constructed an *optometer* on this principle.

Persons who see only at a very short distance are called *myopic*, or *short-sighted*, and those who see only at a long distance are *presbyopic*, or *long-sighted*. *Sharpness of sight* may be compared by reference to that of a normal eye taken as a unit. Such a standard eye, according to Snellen, recognises quadrangular letters when they are seen under an angle of 5'; if for instance such letters are 15<sup>mm</sup> high at a distance of 10 metres. The sharpness of vision of one who recognises these letters at a distance of 3 metres is then  $\frac{3}{10}$ .

602. **Accommodation.**—By this term is meant the changes which occur in the eye to fit it for seeing distinctly objects at different distances from it.

If the eye be supposed fixed and its parts immovable, it is evident that there could only be one surface whose image would fall exactly upon the retina ; the distance of this surface from the eye being dependent on the refractive indices of the media and the curvatures of the refracting surfaces of the eye. The image of any point nearer the eye than this distinctly seen

surface would fall behind the retina ; the image of any more distant point would be formed in front of it : in each case the section of a luminous cone would be perceived instead of the image of the point, and the latter would appear diffused and indistinct.

Experience, however, shows us that a normal eye can see distinct images of objects at very different distances. We can, for example, see a distant tree through a window, and also a scratch on the pane, though not both distinctly at the same moment ; for when the eye is arranged to see one clearly, the image of the other does not fall accurately upon the retina. An eye completely at rest seems adapted for seeing distant objects ; the sense of effort is greater in a normal eye when a near object is looked at, after a distant one, than in the reverse case ; and in paralysis of the nerves governing the accommodating apparatus the eye is persistently adapted for distant sight. There must, therefore, be some mechanism in the eye by which it can be voluntarily altered, so that the more divergent rays proceeding from near objects shall come to a focus upon the retina. There are several conceivable methods by which this might be effected ; it is actually brought about by a drawing forwards of the crystalline lens and a greater convexity of its anterior surface.

This is shown by the following experiment : if a candle be placed on one side of the eye of a person looking at a distant object, and his eye be observed from the other side, three distinct images of the flame will be seen ; the first, virtual and erect, is reflected from the anterior surface of the cornea ; the next, erect and less bright, is reflected from the anterior surface of the lens ; the third, inverted and brilliant, is formed on the posterior surface of the lens. If now the person look at a near object, no change is observed in the first and third images, but the second image becomes smaller and approaches the first ; which shows that the anterior surface of the crystalline lens becomes more convex and approaches the cornea. In place of the candle, Helmholtz throws light through two holes in the screen upon the eye, and observes the distance on the eye between the two shining points, instead of the size of the flame of the candle.

This change in the lens is effected chiefly by means of a circular muscle (ciliary muscle), the contraction of which relaxes the suspensory ligament, and so allows the front surface of the lens to assume more or less of that greater convexity which it would normally exhibit were it not for the drag exercised upon it by the ligament. Certain other less important changes tending to make the lens more convex and to push it forwards occur, which cannot, however, be explained without entering into minute anatomical details. When the eye is accommodated for near vision, the pupil contracts and so partially remedies the greater spherical aberration.

The *range of accommodation*, called by Donders  $\frac{I}{A}$ , is measured by first of all determining the greatest distance, R, at which a person can read without spectacles, and then the smallest, P, at which he can read ;

then

$$\frac{I}{A} = \frac{I}{P} - \frac{I}{R}.$$

603. **Binocular vision.**—A single eye sees most distinctly any point situated on its optical axis, and less distinctly other points also, towards which it is not directly looking, but which still are within its circle of vision.

It is able to judge of the *direction* of any such point, but unable by itself to estimate its *distance*. Of the distance of an *object* it may, indeed, learn to judge by such criteria as loss of colour, indistinctness of outline, decrease in magnitude, etc. ; but if the object is near, the single eye is not infallible, even with these aids.

When the two eyes are directed upon a single point, we then gain the power of judging of its distance as compared with that of any other point, and this we seem to gain by the sense of greater or less effort required in causing the optical axis to converge upon the one point or upon the other. Now a solid object may be regarded as composed of points which are at different distances from the eye. Hence, in looking at such an object, the axes of the two eyes are rapidly and insensibly varying their angle of convergence, and we as rapidly are gaining experience in the difference in distance of the various points of which the object is composed, or, in other words, an assurance of its solidity. Such kind of assurance is necessarily unattainable in monocular vision.

604. **The principle of the stereoscope.**—Let any solid object, such as a small box, be supposed to be held at some short distance before the two eyes. On whatever point of it they are fixed, they will see that point the most distinctly, and other points more or less clearly. But it is evident that, as the two eyes see from different points of view, there will be formed in the right eye a picture of the object different from that formed in the left ; and it

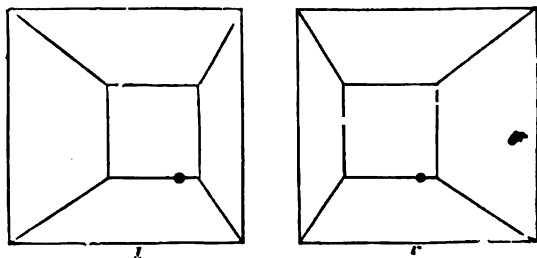

Fig. 496.

is by the apparent union of these two dissimilar pictures that we see the object in relief. If, therefore, we delineate the object, first as seen by the right eye, and then as seen by the left, and afterwards present these dissimilar pictures again to the eyes, taking care to present to each eye that picture which was drawn from its point of view, there would seem to be no reason why we should not see a representation of the object as we saw the object itself, in relief. Experiment confirms the supposition. If the object held before the eyes were a truncated pyramid, *r* and *l*, fig. 496, would represent its principal lines, as seen by the right and left eyes respectively. If a card be held between the figures, and they are steadily looked at, *r* by the

right eye, and  $l$  simultaneously by the left, for a few seconds, there will be seen a single picture having the unmistakable appearance of relief. Even without a card interposed, the eye, by a little practice, may soon be taught so to combine the two as to form this solid picture. Three pictures will in that case be seen, the central being solid, and the two outside ones plane. Fig. 497 will explain this. Let  $r$  and  $l$  be any two corresponding points, say the points marked by a large dot in the figures drawn above;  $R$  and  $L$  the positions of the right and left eyes; then the right eye sees the point  $r$  in the direction  $Rr$ , and the left eye the point  $l$  in the direction  $Ll$ , and accordingly each by itself judging only by the direction, they together see these two points as one, and imagine it to be situated at  $o$ . But the right eye, though looking in the direction  $Rr$ , also receives an image of  $l$  on another part of the retina, and the left eye in the same way an image of  $r$ , and thus three images are seen. A card, however, placed in the position marked by the dotted line will, of course, cut off the two side pictures. To assist the eye in combining such pairs of dissimilar pictures, both mirrors and lenses have been made use of, and the instruments in which either of these are adapted to this end are called *stereoscopes*.

605. **The reflecting stereoscope.**—In the reflecting stereoscope plane mirrors are used to change the apparent position of the pictures, so that they are both seen in the same direction, and their combination by the eye is thus rendered easy and almost inevitable. If  $ab$ ,  $ab$  (fig. 498) are two plane mirrors inclined to one another at an angle of  $90^\circ$  the two arrows,  $x$ ,  $y$ , would both be seen by the eyes situated at  $R$  and  $L$  in the position marked by the dotted arrow. If, instead of the arrows, we now substitute such a pair of dissimilar pictures as we have spoke: of above, of

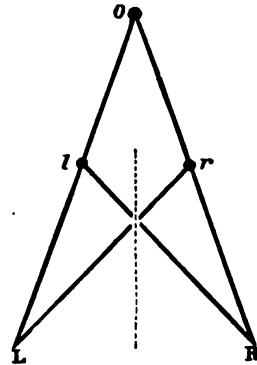

Fig. 497.

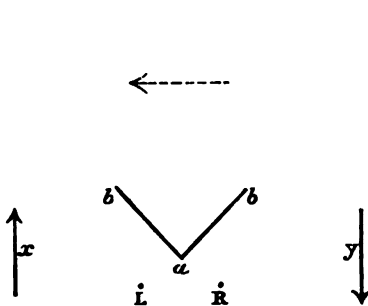

Fig. 498.

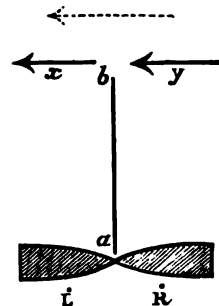

Fig. 499.

the same solid object, it is evident that, if the margins of the pictures coincide, other corresponding points of the pictures will not. The eyes, however, almost without effort, soon bring such points into coincidence, and in so

doing make them appear to recede or advance, as they are farther apart or nearer together than any two corresponding points (the right-hand corner, for instance) of the margins, when the pictures are placed side by side, as in the diagram fig. 498. It will be plain, also, on considering the position for the arrows in fig. 498, that to adapt such pictures as those in fig. 496 to use in a reflecting stereoscope, one of them must be reversed, or drawn as it would be seen through the paper if held up to the light.

606. **The refracting stereoscope.**—Since the rays passing through a convex lens are bent always towards the thicker part of the lens, any segment of such a lens may be readily adapted to change the apparent position of any object seen through it. Thus, if (fig. 499) two segments be cut from a double convex lens, and placed with their edges together, the arrows,  $x$ ,  $y$ , would both be seen in the position of the dotted arrow by the eyes at R and L.

If we substitute for the arrows two dissimilar pictures of the same solid object, or the same landscape, we shall then, if a diaphragm,  $ab$ , be placed between the lenses to prevent the pictures being seen crosswise by the eyes, see but one picture, and that apparently in the centre, and magnified. As before, if the margins are brought by the power of the lenses to coincide, other corresponding points will not be coincident until combined by an almost insensible effort of the eyes. Any pair of corresponding points which are farther apart than any other pair will then be seen farther back in the picture, just as any point in the background of a landscape would be found (if we came to compare two pictures of the landscape, one drawn by the right eye, and the other by the left) to be represented by two points farther apart from one another than two others which represented a point in the foreground.

To anyone curious in such experiments, it will be instructive to notice that there is also a second point on *this side* of the paper, at which, if a

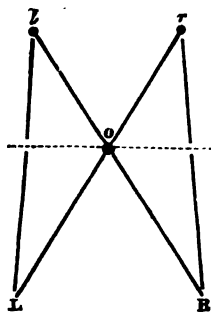

Fig. 500.

person look steadily, the diagrams in fig. 500 will combine, and form quite a different stereoscopic picture. Instead of a solid pyramid, a hollow pyramidal box will then be seen. The point may easily be found by experiment. Here again two external images will also be seen. If we wish to shut these out, and see only their central stereoscopic combination, we must use a diaphragm of paper held parallel to the plane of the picture with a square hole in it. This paper screen must be so adjusted that it may conceal the right-hand figure from the left eye, and the left-hand figure from the right eye, while the central stereoscopic picture may be seen through the hole. It will be plain from the diagram that  $o$  is the point to which

the eyes must be directed, and at which they will imagine the point to be situated, which is formed by the combination of the two points  $r$  and  $l$ . The dotted line shows the position of the screen. A stereoscope with or without lenses may easily be constructed, which will thus give us, with the ordinary stereoscopic slides, a reversed picture; for instance, if the subject be a landscape, the foreground will retire and the background come forward.

When the two retinas view simultaneously two different colours, the impression produced is that of a single mixed tint. The power, however, of combining the two tints into a single one varies in different individuals, and in some is extremely weak. If two white discs at the base of the stereoscope be illuminated by two pencils of complementary colours, and if each coloured disc be looked at with one eye, a single white one is seen, showing that the sensation of white light may arise from two complementary and simultaneous chromatic impressions on each of the two retinas.

Dove states that if a piece of printing and a copy are placed in the stereoscope, a difference in the distance of the words, which is not apparent to the naked eye, causes them to stand out from the plane of the paper.

**607. Persistence of impressions on the retina.**—When an ignited piece of charcoal is rapidly rotated, we cannot distinguish it; the appearance of a circle of fire is produced; similarly, rain, in falling drops, appears in the air like a series of liquid threads. In a rapidly rotating toothed wheel the individual teeth cannot be seen. But if, during darkness, the wheel be suddenly illuminated, as by the electric spark, the individual parts may be clearly made out. These various appearances are due to the fact that the impression of these images on the retina remains for some time after the object which has produced them has disappeared or become displaced. The duration of the persistence varies with the sensitiveness of the retina and the intensity of light. The following experiment is a further illustration of this property. A series of equal sectors are traced on a disc of glass, and they are alternately blackened; in the centre there is a pivot, on which a second disc is fixed of the same dimensions as the first, but completely blackened, with the exception of a single sector; then placing the apparatus between a window and the eye, the second disc is made to rotate. If the movement is slow, all the transparent sectors are seen, but only one at a time; by a more rapid rotation we see simultaneously two, three, or a greater number.

Plateau investigated the duration of the impression by numerous similar methods, and has found that it is on the average half a second. Among many curious instances of these phenomena, the following is one of the most remarkable. If, after having looked at a brightly illuminated window, the eyes are suddenly closed, the image remains for a few instants—that is, a sashwork is seen consisting of luminous panes surrounded by dark frames; after a few seconds the colours become interchanged, the same framework is now seen, but the frames are now bright, and the glasses are perfectly black; this new appearance may again revert to its original appearance.

The impression of colours remains as well as that of the form of objects; for if circles divided into sectors are painted in different colours, they become confounded, and give the sensation of the colour which would result from their mixture. Yellow and red give orange; blue and red violet; the seven colours of the spectrum give white, as shown in Newton's disc (fig. 448). This is a convenient method of studying the tints produced by mixed colours.

A great number of pieces of apparatus are founded on the persistence of sensation on the retina. Such are the *thaumatrope*, the *phenakistoscope*, *Faraday's wheel*, the *kaleidophone*.

608. **Accidental images.**—A coloured object being placed upon a black ground, if it is steadily looked at for some time, the eye is soon tired, and the intensity of the colour enfeebled; if now the eyes are directed towards a white sheet, or to the ceiling, an image will be seen of the same shape as the object, but of the complementary colour (555); that is, such a one as united to that of the object would form white. For a green object the image will be red; if the object is yellow, the image will be violet.

Accidental colours are of longer duration in proportion as the object has been more brilliantly illuminated, and the object has been longer looked at. When a lighted candle has been looked at for some time, and the eyes are turned towards a dark part of the room the appearance of the flame remains, but it gradually changes colour; it is first yellow, then it passes through orange to red, from red through violet to greenish blue, which is gradually feebler until it disappears. If the eye which has been looking at the light be turned towards a white wall, the colours follow almost the opposite direction: there is first a dark picture on a white ground, which gradually changes into blue, is then successively green and yellow, and ultimately cannot be distinguished from a white ground.

The reason of this phenomenon is, doubtless, to be sought in the fact that the subsequent action of light on the retina is not of equal duration for all colours, and that the decrease in the intensity of the subsequent action does not follow the same law for all colours.

609. **Irradiation.**—This is a phenomenon in virtue of which white objects or those of a very bright colour, when seen on a dark ground, appear larger than they really are. Thus a white square upon a black ground seems larger than an exactly equal black square upon a white ground (fig. 501). Irradiation arises from the fact that the impression produced on the retina extends beyond the outline of the image. It bears the same relation to the space occupied by the image that the duration of the impression does to the time during which the image is seen.

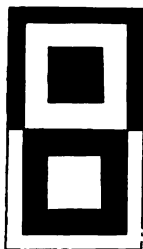

Fig. 501.

The effect of irradiation is very perceptible in the apparent magnitude of stars, which may thus appear much larger than they really are; also in the appearance of the moon when two or three days old, the brightly illuminated crescent seeming to extend beyond the darker portion of the disc, and hold it in its grasp.

Plateau, who investigated this subject, found that irradiation differs very much in different people, and even in the same person it differs on different days. He also found that irradiation increases with the lustre of the object, and the length of time during which it is viewed. It manifests itself at all distances, diverging lenses increase and condensing lenses diminish it.

*Accidental haloes* are the colours which, instead of succeeding the impression of an object like accidental colours, appear round the object itself when it is looked at fixedly. The impression of the halo is the opposite to that of the object: if the object is bright the halo is dark, and *vice versa*. These appearances are best produced in the following manner. A white

surface, such as a sheet of paper, is illuminated by coloured light, and a narrow opaque body held so as to cut off some of the coloured rays. In this manner a narrow shadow is obtained which is illuminated by the surrounding white daylight, and appears complementary to the coloured ground. If red glass is used, the shadow appears green, and blue when a yellow glass is used.

The *contrast of colours* is a reciprocal action exerted between two adjacent colours, and in virtue of which to each one is added the complementary colour of the other. This contrast was studied by M. Chevreul, who found that when red and yellow colours are adjacent, red acquires a violet and yellow an orange tint. If the experiment is made with red and blue, the former acquires a yellow, and the latter a green tint : with yellow and blue, yellow passes to orange, and blue towards indigo : and so on for a vast number of combinations. The importance of this phenomenon in its application to the manufacture of cloths, carpets, curtains, etc., may be readily conceived.

610. **The eye is not achromatic.**—It had long been supposed that the human eye was perfectly achromatic, but this is clearly impossible, as all the refractions are made the same way, viz. towards the axis ; moreover, the experiments of Wollaston, of Young, of Fraunhofer, and of Müller, have shown that it was not true in any absolute sense.

Fraunhofer showed that in a telescope with two lenses, a very fine wire placed inside the instrument in the focus of the object glass is seen distinctly through the eyepiece, when the telescope is illuminated with red light ; but it is invisible by violet light even when the eyepiece is in the same position. In order to see the wire again, the distance of the lenses must be diminished to a far greater extent than would correspond to the degree of refrangibility of violet light in glass. In this case, therefore, the effect must be due to a chromatic aberration in the eye.

Müller, on looking at a white disc on a dark ground, found that the image is sharp when the eye is accommodated to the distance of the disc, that is, when the image forms on the retina ; but he found that if the image is formed in front of or behind the retina, the disc appears surrounded by a very narrow blue edge. If a finger be held up in front of one eye (the other being closed) in such a manner as to allow the light to enter only one-half of the pupil, and, of course, obliquely, and the eye be then directed to any well-defined line of light, such as a slit in the shutter of a darkened room, or a strip of white paper on a black ground, this line of light will appear as a complete spectrum.

Müller concluded from these experiments that the eye is sensibly achromatic as long as the image is received at the focal distance, or when it is accommodated to the distance of the object. The cause of this apparent achromatism cannot be exactly stated. It has generally been attributed to the tenuity of the luminous beams which pass through the pupillary aperture, and that these unequally refrangible rays, meeting the surfaces of the media of the eye almost at the normal incidence, are very little refracted, from which it follows that the chromatic aberration is imperceptible (566).

Spherical aberration, as we have already seen, is corrected by the iris





formula (5), because the image seen by spectacles being on the same side of the object in reference to the lens, the sign of  $p'$  ought to be the opposite of that of  $p$ , as in the case of virtual images from the paragraph already cited.

For short-sighted persons,  $f$  is calculated by the formula  $\frac{1}{p} - \frac{1}{p'} = -\frac{1}{f}$  (545), which refers to concave lenses, and which, replacing  $p'$  by  $d$ , gives

$$f = \frac{pd}{p-d} \quad (2)$$

To calculate, for instance, the number of a glass which a person ought to use in whom the distance of distinct vision is 36, knowing that the distance of ordinary distinct vision is 12 inches; making  $p = 12$  and  $d = 36$  in the above formula (1), we get  $f = \frac{36 \times 12}{36 - 12} = 18$ .

613. **Diplopy.**—*Diplopy* is an affection of the eye which causes objects to be seen double, that is, that two images are seen instead of one. Usually the two images are almost entirely superposed, and one of them is much more distinct than the other. Diplopy may be caused by the co-operation of two unequal eyes, but it may also affect a single eye. The latter case is, doubtless, due to some defect of conformation in the crystalline or other parts of the eye which produces a bifurcation of the luminous ray, and thus two images are formed on the retina instead of one. A single eye may also be affected with *triplopy*, but in this case the third image is exceedingly weak.

614. **Achromatopsy. Daltonism.**—*Achromatopsy*, or *colour disease*, is a curious affection which renders us incapable of distinguishing colours, or at any rate certain colours. Persons affected in this manner can distinguish the outlines of bodies without difficulty, and they can also discriminate between light and shade, but they are unable to distinguish the different colours.

The commonest case is that of red-blindness; Dalton had it in a pre-eminent degree, and from the fact that he has very carefully described it, the disease is often known as *Daltonism*. To a person so affected, red appears like black, and the brighter shades bluish-green; bluish-green and white seem the same, or at all events only different in shade. Yellow appears like green, but he distinguishes between them, for the yellow appears brighter.

He who is blind for green, sees that colour as black, and its lighter shades red. He only sees red and blue with their intermediate stages; yellow appears bright red; white and pink are alike, the spectrum is only red and blue; in the green there is a grey band. Violet-blindness is very seldom and not well known; it can be artificially produced by taking *Santonine*. Colour disease is congenital; it has been produced by straining the eyes in dim light.

615. **Ophthalmoscope.**—This instrument, as its name indicates, is designed for the examination of the eye, and was invented in 1851 by Prof. Helmholtz. It consists:—1. Of a concave spherical reflector of glass or metal, M (figs. 502, 503), in the middle of which is a small hole about a sixth of an inch in diameter. The focal length of the reflector is from 8 to 10 inches. 2. Of a converging achromatic lens,  $o$ , which is held in front of the eye of the patient. 3. Of several lenses, some convergent, others divergent, any one of which can be fixed in a frame behind the mirror so as to

small angle, and occupy but a small space in the field of view, our familiarity with the effects of aerial perspective enables us to form a correct idea of their real magnitude.

The optic angle is also an essential element in appreciating distance. This angle increasing or diminishing according as objects approach or recede, we move our eyes so as to make their optic axes converge towards the object which we are looking at, and thus obtain an idea of its distance. Nevertheless, it is only by long custom that we can establish a relation between our distance from the objects and the corresponding motion of the eyes. It is a curious fact that persons born blind, and whose sight has been restored by the operation for cataract, imagine at first that all objects are at the same distance.

Vertical distances are estimated too low compared with horizontal ones ; on high mountains and over large surfaces of water, distances are estimated too low owing to the want of intervening objects.

We cannot recognise the true form of an object if the visual angle is less than half a minute. A white square, a metre in the side, appears at a distance of about 5 miles under this angle as a bright spot which can scarcely be distinguished from a circle of the same size.

601. **Distance of distinct vision.**—The *distance of distinct vision* is, as already stated, the distance at which objects must be placed so as to be seen with the greatest distinctness. It varies in different individuals, and in the same individual it is often different in the two eyes. For small objects, such as print, it is from 10 to 12 inches in normal cases.

In order to obtain an approximate measurement of the least distance of distinct vision, two small parallel slits are made in a card at a distance of 0·03 of an inch. These apertures are held close before the eye, and when a fine slit in another card is held very near these apertures, the slit is seen double, because the rays of light which have traversed both apertures do not intersect each other on the retina, but behind it. But, if the latter card is gradually removed, the distance is ultimately reached at which both images coincide and form one distinct image. This is the distance of distinct vision. Stampfer has constructed an *optometer* on this principle.

Persons who see only at a very short distance are called *myopic*, or *short-sighted*, and those who see only at a long distance are *presbyopic*, or *long-sighted*. *Sharpness of sight* may be compared by reference to that of a normal eye taken as a unit. Such a standard eye, according to Snellen, recognises quadrangular letters when they are seen under an angle of 5'; if for instance such letters are 15<sup>mm</sup> high at a distance of 10 metres. The sharpness of vision of one who recognises these letters at a distance of 3 metres is then  $\frac{3}{10}$ .

602. **Accommodation.**—By this term is meant the changes which occur in the eye to fit it for seeing distinctly objects at different distances from it.

If the eye be supposed fixed and its parts immovable, it is evident that there could only be one surface whose image would fall exactly upon the retina ; the distance of this surface from the eye being dependent on the refractive indices of the media and the curvatures of the refracting surfaces of the eye. The image of any point nearer the eye than this distinctly seen

surface would fall behind the retina ; the image of any more distant point would be formed in front of it : in each case the section of a luminous cone would be perceived instead of the image of the point, and the latter would appear diffused and indistinct.

Experience, however, shows us that a normal eye can see distinct images of objects at very different distances. We can, for example, see a distant tree through a window, and also a scratch on the pane, though not both distinctly at the same moment ; for when the eye is arranged to see one clearly, the image of the other does not fall accurately upon the retina. An eye completely at rest seems adapted for seeing distant objects ; the sense of effort is greater in a normal eye when a near object is looked at, after a distant one, than in the reverse case ; and in paralysis of the nerves governing the accommodating apparatus the eye is persistently adapted for distant sight. There must, therefore, be some mechanism in the eye by which it can be voluntarily altered, so that the more divergent rays proceeding from near objects shall come to a focus upon the retina. There are several conceivable methods by which this might be effected ; it is actually brought about by a drawing forwards of the crystalline lens and a greater convexity of its anterior surface.

This is shown by the following experiment : if a candle be placed on one side of the eye of a person looking at a distant object, and his eye be observed from the other side, three distinct images of the flame will be seen ; the first, virtual and erect, is reflected from the anterior surface of the cornea ; the next, erect and less bright, is reflected from the anterior surface of the lens ; the third, inverted and brilliant, is formed on the posterior surface of the lens. If now the person look at a near object, no change is observed in the first and third images, but the second image becomes smaller and approaches the first ; which shows that the anterior surface of the crystalline lens becomes more convex and approaches the cornea. In place of the candle, Helmholtz throws light through two holes in the screen upon the eye, and observes the distance on the eye between the two shining points, instead of the size of the flame of the candle.

This change in the lens is effected chiefly by means of a circular muscle (ciliary muscle), the contraction of which relaxes the suspensory ligament, and so allows the front surface of the lens to assume more or less of that greater convexity which it would normally exhibit were it not for the drag exercised upon it by the ligament. Certain other less important changes tending to make the lens more convex and to push it forwards occur, which cannot, however, be explained without entering into minute anatomical details. When the eye is accommodated for near vision, the pupil contracts and so partially remedies the greater spherical aberration.

The *range of accommodation*, called by Donders  $\frac{I}{A}$ , is measured by first of all determining the greatest distance, R, at which a person can read without spectacles, and then the smallest, P, at which he can read ;

then

$$\frac{I}{A} = \frac{I}{P} - \frac{I}{R}.$$

603. **Binocular vision.**—A single eye sees most distinctly any point situated on its optical axis, and less distinctly other points also, towards which it is not directly looking, but which still are within its circle of vision.

It is able to judge of the *direction* of any such point, but unable by itself to estimate its *distance*. Of the distance of an *object* it may, indeed, learn to judge by such criteria as loss of colour, indistinctness of outline, decrease in magnitude, etc. ; but if the object is near, the single eye is not infallible, even with these aids.

When the two eyes are directed upon a single point, we then gain the power of judging of its distance as compared with that of any other point, and this we seem to gain by the sense of greater or less effort required in causing the optical axis to converge upon the one point or upon the other. Now a solid object may be regarded as composed of points which are at different distances from the eye. Hence, in looking at such an object, the axes of the two eyes are rapidly and insensibly varying their angle of convergence, and we as rapidly are gaining experience in the difference in distance of the various points of which the object is composed, or, in other words, an assurance of its solidity. Such kind of assurance is necessarily unattainable in monocular vision.

604. **The principle of the stereoscope.**—Let any solid object, such as a small box, be supposed to be held at some short distance before the two eyes. On whatever point of it they are fixed, they will see that point the most distinctly, and other points more or less clearly. But it is evident that, as the two eyes see from different points of view, there will be formed in the right eye a picture of the object different from that formed in the left ; and it

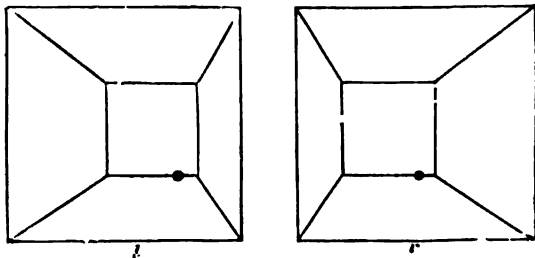

Fig. 496.

is by the apparent union of these two dissimilar pictures that we see the object in relief. If, therefore, we delineate the object, first as seen by the right eye, and then as seen by the left, and afterwards present these dissimilar pictures again to the eyes, taking care to present to each eye that picture which was drawn from its point of view, there would seem to be no reason why we should not see a representation of the object as we saw the object itself, in relief. Experiment confirms the supposition. If the object held before the eyes were a truncated pyramid, *r* and *l*, fig. 496, would represent its principal lines, as seen by the right and left eyes respectively. If a card be held between the figures, and they are steadily looked at, *r* by the

right eye, and  $l$  simultaneously by the left, for a few seconds, there will be seen a single picture having the unmistakable appearance of relief. Even without a card interposed, the eye, by a little practice, may soon be taught so to combine the two as to form this solid picture. Three pictures will in that case be seen, the central being solid, and the two outside ones plane. Fig. 497 will explain this. Let  $r$  and  $l$  be any two corresponding points, say the points marked by a large dot in the figures drawn above;  $R$  and  $L$  the positions of the right and left eyes; then the right eye sees the point  $r$  in the direction  $Ro$ , and the left eye the point  $l$  in the direction  $Lo$ , and accordingly each by itself judging only by the direction, they together see these two points as one, and imagine it to be situated at  $o$ . But the right eye, though looking in the direction  $Rr$ , also receives an image of  $l$  on another part of the retina, and the left eye in the same way an image of  $r$ , and thus three images are seen. A card, however, placed in the position marked by the dotted line will, of course, cut off the two side pictures. To assist the eye in combining such pairs of dissimilar pictures, both mirrors and lenses have been made use of, and the instruments in which either of these are adapted to this end are called *stereoscopes*.

605. **The reflecting stereoscope.**—In the reflecting stereoscope plane mirrors are used to change the apparent position of the pictures, so that they are both seen in the same direction, and their combination by the eye is thus rendered easy and almost inevitable. If  $ab$ ,  $ab$  (fig. 498) are two plane mirrors inclined to one another at an angle of  $90^\circ$  the two arrows,  $x$ ,  $y$ , would both be seen by the eyes situated at  $R$  and  $L$  in the position marked by the dotted arrow. If, instead of the arrows, we now substitute such a pair of dissimilar pictures as we have spoken of above, of

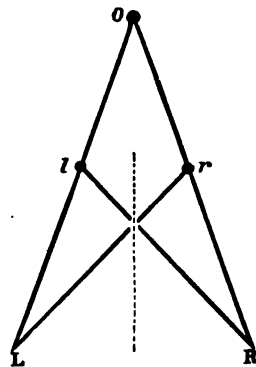

Fig. 497.

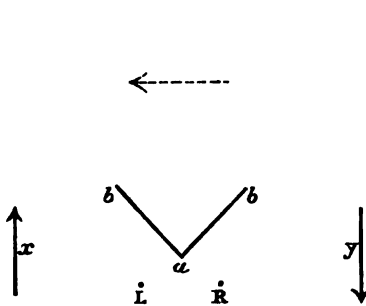

Fig. 498.

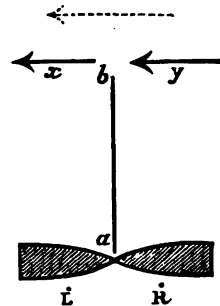

Fig. 499.

the same solid object, it is evident that, if the margins of the pictures coincide, other corresponding points of the pictures will not. The eyes, however, almost without effort, soon bring such points into coincidence, and in so

doing make them appear to recede or advance, as they are farther apart or nearer together than any two corresponding points (the right-hand corner, for instance) of the margins, when the pictures are placed side by side, as in the diagram fig. 498. It will be plain, also, on considering the position for the arrows in fig. 498, that to adapt such pictures as those in fig. 496 to use in a reflecting stereoscope, one of them must be reversed, or drawn as it would be seen through the paper if held up to the light.

606. **The refracting stereoscope.**—Since the rays passing through a convex lens are bent always towards the thicker part of the lens, any segment of such a lens may be readily adapted to change the apparent position of any object seen through it. Thus, if (fig. 499) two segments be cut from a double convex lens, and placed with their edges together, the arrows,  $x$ ,  $y$ , would both be seen in the position of the dotted arrow by the eyes at R and L.

If we substitute for the arrows two dissimilar pictures of the same solid object, or the same landscape, we shall then, if a diaphragm,  $ab$ , be placed between the lenses to prevent the pictures being seen crosswise by the eyes, see but one picture, and that apparently in the centre, and magnified. As before, if the margins are brought by the power of the lenses to coincide, other corresponding points will not be coincident until combined by an almost insensible effort of the eyes. Any pair of corresponding points which are farther apart than any other pair will then be seen farther back in the picture, just as any point in the background of a landscape would be found (if we came to compare two pictures of the landscape, one drawn by the right eye, and the other by the left) to be represented by two points farther apart from one another than two others which represented a point in the foreground.

To anyone curious in such experiments, it will be instructive to notice that there is also a second point on *this side* of the paper, at which, if a person look steadily, the diagrams in fig. 500 will combine, and form quite a different stereoscopic picture. Instead of a solid pyramid, a hollow pyramidal box will then be seen. The point may easily be found by experiment. Here again two external images will also be seen. If we wish to shut these out, and see only their central stereoscopic combination, we must use a diaphragm of paper held parallel to the plane of the picture with a square hole in it. This paper screen must be so adjusted that it may conceal the right-hand figure from the left eye, and the left-hand figure from the right eye, while the central stereoscopic picture may be seen through the hole. It will be plain from the diagram that  $o$  is the point to which the eyes must be directed, and at which they will imagine the point to be situated, which is formed by the combination of the two points  $r$  and  $l$ . The dotted line shows the position of the screen. A stereoscope with or without lenses may easily be constructed, which will thus give us, with the ordinary stereoscopic slides, a reversed picture; for instance, if the subject be a landscape, the foreground will retire and the background come forward.

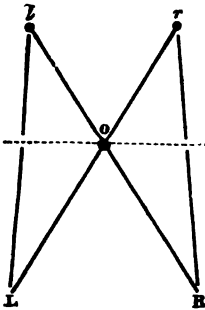

Fig. 500.

When the two retinas view simultaneously two different colours, the impression produced is that of a single mixed tint. The power, however, of combining the two tints into a single one varies in different individuals, and in some is extremely weak. If two white discs at the base of the stereoscope be illuminated by two pencils of complementary colours, and if each coloured disc be looked at with one eye, a single white one is seen, showing that the sensation of white light may arise from two complementary and simultaneous chromatic impressions on each of the two retinas.

Dove states that if a piece of printing and a copy are placed in the stereoscope, a difference in the distance of the words, which is not apparent to the naked eye, causes them to stand out from the plane of the paper.

607. **Persistence of impressions on the retina.**—When an ignited piece of charcoal is rapidly rotated, we cannot distinguish it; the appearance of a circle of fire is produced; similarly, rain, in falling drops, appears in the air like a series of liquid threads. In a rapidly rotating toothed wheel the individual teeth cannot be seen. But if, during darkness, the wheel be suddenly illuminated, as by the electric spark, the individual parts may be clearly made out. These various appearances are due to the fact that the impression of these images on the retina remains for some time after the object which has produced them has disappeared or become displaced. The duration of the persistence varies with the sensitiveness of the retina and the intensity of light. The following experiment is a further illustration of this property. A series of equal sectors are traced on a disc of glass, and they are alternately blackened; in the centre there is a pivot, on which a second disc is fixed of the same dimensions as the first, but completely blackened, with the exception of a single sector; then placing the apparatus between a window and the eye, the second disc is made to rotate. If the movement is slow, all the transparent sectors are seen, but only one at a time; by a more rapid rotation we see simultaneously two, three, or a greater number.

Plateau investigated the duration of the impression by numerous similar methods, and has found that it is on the average half a second. Among many curious instances of these phenomena, the following is one of the most remarkable. If, after having looked at a brightly illuminated window, the eyes are suddenly closed, the image remains for a few instants—that is, a sashwork is seen consisting of luminous panes surrounded by dark frames; after a few seconds the colours become interchanged, the same framework is now seen, but the frames are now bright, and the glasses are perfectly black; this new appearance may again revert to its original appearance.

The impression of colours remains as well as that of the form of objects; for if circles divided into sectors are painted in different colours, they become confounded, and give the sensation of the colour which would result from their mixture. Yellow and red give orange; blue and red violet; the seven colours of the spectrum give white, as shown in Newton's disc (fig. 448). This is a convenient method of studying the tints produced by mixed colours.

A great number of pieces of apparatus are founded on the persistence of sensation on the retina. Such are the *thaumatrope*, the *phenakistoscope*, *Faraday's wheel*, the *kaleidophone*.



608. **Accidental images.**—A coloured object being placed upon a black ground, if it is steadily looked at for some time, the eye is soon tired, and the intensity of the colour enfeebled; if now the eyes are directed towards a white sheet, or to the ceiling, an image will be seen of the same shape as the object, but of the complementary colour (555); that is, such a one as united to that of the object would form white. For a green object the image will be red; if the object is yellow, the image will be violet.

Accidental colours are of longer duration in proportion as the object has been more brilliantly illuminated, and the object has been longer looked at. When a lighted candle has been looked at for some time, and the eyes are turned towards a dark part of the room the appearance of the flame remains, but it gradually changes colour; it is first yellow, then it passes through orange to red, from red through violet to greenish blue, which is gradually feeblener until it disappears. If the eye which has been looking at the light be turned towards a white wall, the colours follow almost the opposite direction: there is first a dark picture on a white ground, which gradually changes into blue, is then successively green and yellow, and ultimately cannot be distinguished from a white ground.

The reason of this phenomenon is, doubtless, to be sought in the fact that the subsequent action of light on the retina is not of equal duration for all colours, and that the decrease in the intensity of the subsequent action does not follow the same law for all colours.

609. **Irradiation.**—This is a phenomenon in virtue of which white objects or those of a very bright colour, when seen on a dark ground, appear larger than they really are. Thus a white square upon a black ground seems larger than an exactly equal black square upon a white ground (fig. 501). Irradiation arises from the fact that the impression produced on the retina extends beyond the outline of the image. It bears the same relation to the space occupied by the image that the duration of the impression does to the time during which the image is seen.

The effect of irradiation is very perceptible in the apparent magnitude of stars, which may thus appear much larger than they really are; also in the appearance of the moon when two or three days old, the brightly illuminated crescent seeming to extend beyond the darker portion of the disc, and hold it in its grasp.

Plateau, who investigated this subject, found that irradiation differs very much in different people, and even in the same person it differs on different days. He also found that irradiation increases with the lustre of the object, and the length of time during which it is viewed. It manifests itself at all distances, diverging lenses increase and condensing lenses diminish it.

*Accidental haloes* are the colours which, instead of succeeding the impression of an object like accidental colours, appear round the object itself when it is looked at fixedly. The impression of the halo is the opposite to that of the object: if the object is bright the halo is dark, and *vice versâ*. These appearances are best produced in the following manner. A white



Fig. 501

surface, such as a sheet of paper, is illuminated by coloured light, and a narrow opaque body held so as to cut off some of the coloured rays. In this manner a narrow shadow is obtained which is illuminated by the surrounding white daylight, and appears complementary to the coloured ground. If red glass is used, the shadow appears green, and blue when a yellow glass is used.

The *contrast of colours* is a reciprocal action exerted between two adjacent colours, and in virtue of which to each one is added the complementary colour of the other. This contrast was studied by M. Chevreul, who found that when red and yellow colours are adjacent, red acquires a violet and yellow an orange tint. If the experiment is made with red and blue, the former acquires a yellow, and the latter a green tint : with yellow and blue, yellow passes to orange, and blue towards indigo : and so on for a vast number of combinations. The importance of this phenomenon in its application to the manufacture of cloths, carpets, curtains, etc., may be readily conceived.

610. **The eye is not achromatic.**—It had long been supposed that the human eye was perfectly achromatic, but this is clearly impossible, as all the refractions are made the same way, viz. towards the axis ; moreover, the experiments of Wollaston, of Young, of Fraunhofer, and of Müller, have shown that it was not true in any absolute sense.

Fraunhofer showed that in a telescope with two lenses, a very fine wire placed inside the instrument in the focus of the object glass is seen distinctly through the eyepiece, when the telescope is illuminated with red light ; but it is invisible by violet light even when the eyepiece is in the same position. In order to see the wire again, the distance of the lenses must be diminished to a far greater extent than would correspond to the degree of refrangibility of violet light in glass. In this case, therefore, the effect must be due to a chromatic aberration in the eye.

Müller, on looking at a white disc on a dark ground, found that the image is sharp when the eye is accommodated to the distance of the disc, that is, when the image forms on the retina ; but he found that if the image is formed in front of or behind the retina, the disc appears surrounded by a very narrow blue edge. If a finger be held up in front of one eye (the other being closed) in such a manner as to allow the light to enter only one-half of the pupil, and, of course, obliquely, and the eye be then directed to any well-defined line of light, such as a slit in the shutter of a darkened room, or a strip of white paper on a black ground, this line of light will appear as a complete spectrum.

Müller concluded from these experiments that the eye is sensibly achromatic as long as the image is received at the focal distance, or when it is accommodated to the distance of the object. The cause of this apparent achromatism cannot be exactly stated. It has generally been attributed to the tenuity of the luminous beams which pass through the pupillary aperture, and that these unequally refrangible rays, meeting the surfaces of the media of the eye almost at the normal incidence, are very little refracted, from which it follows that the chromatic aberration is imperceptible (566).

Spherical aberration, as we have already seen, is corrected by the iris

small angle, and occupy but a small space in the field of view, our familiarity with the effects of aerial perspective enables us to form a correct idea of their real magnitude.

The optic angle is also an essential element in appreciating distance. This angle increasing or diminishing according as objects approach or recede, we move our eyes so as to make their optic axes converge towards the object which we are looking at, and thus obtain an idea of its distance. Nevertheless, it is only by long custom that we can establish a relation between our distance from the objects and the corresponding motion of the eyes. It is a curious fact that persons born blind, and whose sight has been restored by the operation for cataract, imagine at first that all objects are at the same distance.

Vertical distances are estimated too low compared with horizontal ones ; on high mountains and over large surfaces of water, distances are estimated too low owing to the want of intervening objects.

We cannot recognise the true form of an object if the visual angle is less than half a minute. A white square, a metre in the side, appears at a distance of about 5 miles under this angle as a bright spot which can scarcely be distinguished from a circle of the same size.

601. **Distance of distinct vision.**—The *distance of distinct vision* is, as already stated, the distance at which objects must be placed so as to be seen with the greatest distinctness. It varies in different individuals, and in the same individual it is often different in the two eyes. For small objects, such as print, it is from 10 to 12 inches in normal cases.

In order to obtain an approximate measurement of the least distance of distinct vision, two small parallel slits are made in a card at a distance of 0.03 of an inch. These apertures are held close before the eye, and when a fine slit in another card is held very near these apertures, the slit is seen double, because the rays of light which have traversed both apertures do not intersect each other on the retina, but behind it. But, if the latter card is gradually removed, the distance is ultimately reached at which both images coincide and form one distinct image. This is the distance of distinct vision. Stampfer has constructed an *optometer* on this principle.

Persons who see only at a very short distance are called *myopic*, or *short-sighted*, and those who see only at a long distance are *presbyopic*, or *long-sighted*. *Sharpness of sight* may be compared by reference to that of a normal eye taken as a unit. Such a standard eye, according to Snellen, recognises quadrangular letters when they are seen under an angle of 5'; if for instance such letters are 15<sup>m</sup> high at a distance of 10 metres. The sharpness of vision of one who recognises these letters at a distance of 3 metres is then  $\frac{3}{10}$ .

602. **Accommodation.**—By this term is meant the changes which occur in the eye to fit it for seeing distinctly objects at different distances from it.

If the eye be supposed fixed and its parts immovable, it is evident that there could only be one surface whose image would fall exactly upon the retina ; the distance of this surface from the eye being dependent on the refractive indices of the media and the curvatures of the refracting surfaces of the eye. The image of any point nearer the eye than this distinctly seen

surface would fall behind the retina ; the image of any more distant point would be formed in front of it : in each case the section of a luminous cone would be perceived instead of the image of the point, and the latter would appear diffused and indistinct.

Experience, however, shows us that a normal eye can see distinct images of objects at very different distances. We can, for example, see a distant tree through a window, and also a scratch on the pane, though not both distinctly at the same moment ; for when the eye is arranged to see one clearly, the image of the other does not fall accurately upon the retina. An eye completely at rest seems adapted for seeing distant objects ; the sense of effort is greater in a normal eye when a near object is looked at, after a distant one, than in the reverse case ; and in paralysis of the nerves governing the accommodating apparatus the eye is persistently adapted for distant sight. There must, therefore, be some mechanism in the eye by which it can be voluntarily altered, so that the more divergent rays proceeding from near objects shall come to a focus upon the retina. There are several conceivable methods by which this might be effected ; it is actually brought about by a drawing forwards of the crystalline lens and a greater convexity of its anterior surface.

This is shown by the following experiment : if a candle be placed on one side of the eye of a person looking at a distant object, and his eye be observed from the other side, three distinct images of the flame will be seen ; the first, virtual and erect, is reflected from the anterior surface of the cornea ; the next, erect and less bright, is reflected from the anterior surface of the lens ; the third, inverted and brilliant, is formed on the posterior surface of the lens. If now the person look at a near object, no change is observed in the first and third images, but the second image becomes smaller and approaches the first ; which shows that the anterior surface of the crystalline lens becomes more convex and approaches the cornea. In place of the candle, Helmholtz throws light through two holes in the screen upon the eye, and observes the distance on the eye between the two shining points, instead of the size of the flame of the candle.

This change in the lens is effected chiefly by means of a circular muscle (ciliary muscle), the contraction of which relaxes the suspensory ligament, and so allows the front surface of the lens to assume more or less of that greater convexity which it would normally exhibit were it not for the drag exercised upon it by the ligament. Certain other less important changes tending to make the lens more convex and to push it forwards occur, which cannot, however, be explained without entering into minute anatomical details. When the eye is accommodated for near vision, the pupil contracts and so partially remedies the greater spherical aberration.

The *range of accommodation*, called by Donders  $\frac{I}{A}$ , is measured by first of all determining the greatest distance, R, at which a person can read without spectacles, and then the smallest, P, at which he can read ;

then

$$\frac{I}{A} = \frac{I}{P} - \frac{I}{R}.$$

603. **Binocular vision.**—A single eye sees most distinctly any point situated on its optical axis, and less distinctly other points also, towards which it is not directly looking, but which still are within its circle of vision.

It is able to judge of the *direction* of any such point, but unable by itself to estimate its *distance*. Of the distance of an *object* it may, indeed, learn to judge by such criteria as loss of colour, indistinctness of outline, decrease in magnitude, etc. ; but if the object is near, the single eye is not infallible, even with these aids.

When the two eyes are directed upon a single point, we then gain the power of judging of its distance as compared with that of any other point, and this we seem to gain by the sense of greater or less effort required in causing the optical axis to converge upon the one point or upon the other. Now a solid object may be regarded as composed of points which are at different distances from the eye. Hence, in looking at such an object, the axes of the two eyes are rapidly and insensibly varying their angle of convergence, and we as rapidly are gaining experience in the difference in distance of the various points of which the object is composed, or, in other words, an assurance of its solidity. Such kind of assurance is necessarily unattainable in monocular vision.

604. **The principle of the stereoscope.**—Let any solid object, such as a small box, be supposed to be held at some short distance before the two eyes. On whatever point of it they are fixed, they will see that point the most distinctly, and other points more or less clearly. But it is evident that, as the two eyes see from different points of view, there will be formed in the right eye a picture of the object different from that formed in the left ; and it

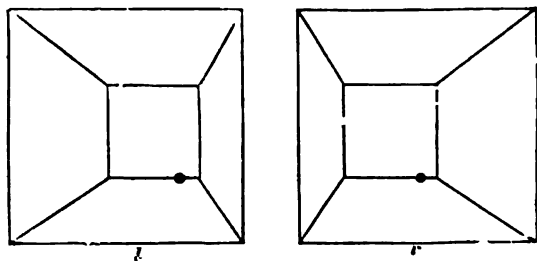

Fig. 496.

is by the apparent union of these two dissimilar pictures that we see the object in relief. If, therefore, we delineate the object, first as seen by the right eye, and then as seen by the left, and afterwards present these dissimilar pictures again to the eyes, taking care to present to each eye that picture which was drawn from its point of view, there would seem to be no reason why we should not see a representation of the object as we saw the object itself, in relief. Experiment confirms the supposition. If the object held before the eyes were a truncated pyramid, *r* and *l*, fig. 496, would represent its principal lines, as seen by the right and left eyes respectively. If a card be held between the figures, and they are steadily looked at, *r* by the

right eye, and  $l$  simultaneously by the left, for a few seconds, there will be seen a single picture having the unmistakable appearance of relief. Even without a card interposed, the eye, by a little practice, may soon be taught so to combine the two as to form this solid picture. Three pictures will in that case be seen, the central being solid, and the two outside ones plane. Fig. 497 will explain this. Let  $r$  and  $l$  be any two corresponding points, say the points marked by a large dot in the figures drawn above;  $R$  and  $L$  the positions of the right and left eyes; then the right eye sees the point  $r$  in the direction  $Rr$ , and the left eye the point  $l$  in the direction  $Ll$ , and accordingly each by itself judging only by the direction, they together see these two points as one, and imagine it to be situated at  $o$ . But the right eye, though looking in the direction  $Rr$ , also receives an image of  $l$  on another part of the retina, and the left eye in the same way an image of  $r$ , and thus three images are seen. A card, however, placed in the position marked by the dotted line will, of course, cut off the two side pictures. To assist the eye in combining such pairs of dissimilar pictures, both mirrors and lenses have been made use of, and the instruments in which either of these are adapted to this end are called *stereoscopes*.

605. **The reflecting stereoscope.**—In the reflecting stereoscope plane mirrors are used to change the apparent position of the pictures, so that they are both seen in the same direction, and their combination by the eye is thus rendered easy and almost inevitable. If  $ab$ ,  $ab$  (fig. 498) are two plane mirrors inclined to one another at an angle of  $90^\circ$  the two arrows,  $x$ ,  $y$ , would both be seen by the eyes situated at  $R$  and  $L$  in the position marked by the dotted arrow. If, instead of the arrows, we now substitute such a pair of dissimilar pictures as we have spoke of above, of

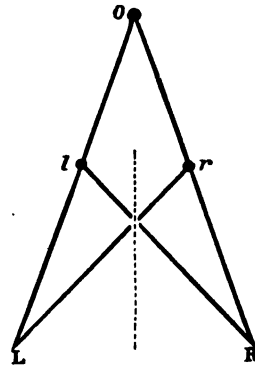

Fig. 497.

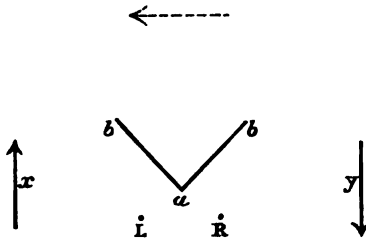

Fig. 498.

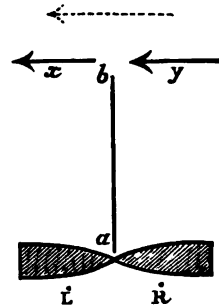

Fig. 499.

the same solid object, it is evident that, if the margins of the pictures coincide, other corresponding points of the pictures will not. The eyes, however, almost without effort, soon bring such points into coincidence, and in so

doing make them appear to recede or advance, as they are farther apart or nearer together than any two corresponding points (the right-hand corner, for instance) of the margins, when the pictures are placed side by side, as in the diagram fig. 498. It will be plain, also, on considering the position for the arrows in fig. 498, that to adapt such pictures as those in fig. 496 to use in a reflecting stereoscope, one of them must be reversed, or drawn as it would be seen through the paper if held up to the light.

606. **The refracting stereoscope.**—Since the rays passing through a convex lens are bent always towards the thicker part of the lens, any segment of such a lens may be readily adapted to change the apparent position of any object seen through it. Thus, if (fig. 499) two segments be cut from a double convex lens, and placed with their edges together, the arrows,  $x$ ,  $y$ , would both be seen in the position of the dotted arrow by the eyes at R and L.

If we substitute for the arrows two dissimilar pictures of the same solid object, or the same landscape, we shall then, if a diaphragm,  $ab$ , be placed between the lenses to prevent the pictures being seen crosswise by the eyes, see but one picture, and that apparently in the centre, and magnified. As before, if the margins are brought by the power of the lenses to coincide, other corresponding points will not be coincident until combined by an almost insensible effort of the eyes. Any pair of corresponding points which are farther apart than any other pair will then be seen farther back in the picture, just as any point in the background of a landscape would be found (if we came to compare two pictures of the landscape, one drawn by the right eye, and the other by the left) to be represented by two points farther apart from one another than two others which represented a point in the foreground.

To anyone curious in such experiments, it will be instructive to notice that there is also a second point on *this side* of the paper, at which, if a person look steadily, the diagrams in fig. 500 will combine, and form quite a different stereoscopic picture. Instead of a solid pyramid, a hollow pyramidal box will then be seen. The point may easily be found by experiment. Here again two external images will also be seen. If we wish to shut these out, and see only their central stereoscopic combination, we must use a diaphragm of paper held parallel to the plane of the picture with a square hole in it. This paper screen must be so adjusted that it may conceal the right-hand figure from the left eye, and the left-hand figure from the right eye, while the central stereoscopic picture may be seen through the hole. It will be plain from the diagram that  $o$  is the point to which the eyes must be directed, and at which they will imagine the point to be situated, which is formed by the combination of the two points  $r$  and  $l$ . The dotted line shows the position of the screen. A stereoscope with or without lenses may easily be constructed, which will thus give us, with the ordinary stereoscopic slides, a reversed picture; for instance, if the subject be a landscape, the foreground will retire and the background come forward.

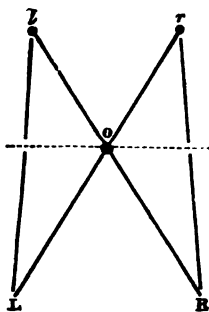

Fig. 500.

When the two retinas view simultaneously two different colours, the impression produced is that of a single mixed tint. The power, however, of combining the two tints into a single one varies in different individuals, and in some is extremely weak. If two white discs at the base of the stereoscope be illuminated by two pencils of complementary colours, and if each coloured disc be looked at with one eye, a single white one is seen, showing that the sensation of white light may arise from two complementary and simultaneous chromatic impressions on each of the two retinas.

Dove states that if a piece of printing and a copy are placed in the stereoscope, a difference in the distance of the words, which is not apparent to the naked eye, causes them to stand out from the plane of the paper.

607. **Persistence of impressions on the retina.**—When an ignited piece of charcoal is rapidly rotated, we cannot distinguish it; the appearance of a circle of fire is produced; similarly, rain, in falling drops, appears in the air like a series of liquid threads. In a rapidly rotating toothed wheel the individual teeth cannot be seen. But if, during darkness, the wheel be suddenly illuminated, as by the electric spark, the individual parts may be clearly made out. These various appearances are due to the fact that the impression of these images on the retina remains for some time after the object which has produced them has disappeared or become displaced. The duration of the persistence varies with the sensitiveness of the retina and the intensity of light. The following experiment is a further illustration of this property. A series of equal sectors are traced on a disc of glass, and they are alternately blackened; in the centre there is a pivot, on which a second disc is fixed of the same dimensions as the first, but completely blackened, with the exception of a single sector; then placing the apparatus between a window and the eye, the second disc is made to rotate. If the movement is slow, all the transparent sectors are seen, but only one at a time; by a more rapid rotation we see simultaneously two, three, or a greater number.

Plateau investigated the duration of the impression by numerous similar methods, and has found that it is on the average half a second. Among many curious instances of these phenomena, the following is one of the most remarkable. If, after having looked at a brightly illuminated window, the eyes are suddenly closed, the image remains for a few instants—that is, a sashwork is seen consisting of luminous panes surrounded by dark frames; after a few seconds the colours become interchanged, the same framework is now seen, but the frames are now bright, and the glasses are perfectly black; this new appearance may again revert to its original appearance.

The impression of colours remains as well as that of the form of objects; for if circles divided into sectors are painted in different colours, they become confounded, and give the sensation of the colour which would result from their mixture. Yellow and red give orange; blue and red violet; the seven colours of the spectrum give white, as shown in Newton's disc (fig. 448). This is a convenient method of studying the tints produced by mixed colours.

A great number of pieces of apparatus are founded on the persistence of sensation on the retina. Such are the *thaumatrope*, the *phenakistoscope*, *Faraday's wheel*, the *kaleidophone*.



608. **Accidental images.**—A coloured object being placed upon a black ground, if it is steadily looked at for some time, the eye is soon tired, and the intensity of the colour enfeebled; if now the eyes are directed towards a white sheet, or to the ceiling, an image will be seen of the same shape as the object, but of the complementary colour (555); that is, such a one as united to that of the object would form white. For a green object the image will be red; if the object is yellow, the image will be violet.

Accidental colours are of longer duration in proportion as the object has been more brilliantly illuminated, and the object has been longer looked at. When a lighted candle has been looked at for some time, and the eyes are turned towards a dark part of the room the appearance of the flame remains, but it gradually changes colour; it is first yellow, then it passes through orange to red, from red through violet to greenish blue, which is gradually feebler until it disappears. If the eye which has been looking at the light be turned towards a white wall, the colours follow almost the opposite direction: there is first a dark picture on a white ground, which gradually changes into blue, is then successively green and yellow, and ultimately cannot be distinguished from a white ground.

The reason of this phenomenon is, doubtless, to be sought in the fact that the subsequent action of light on the retina is not of equal duration for all colours, and that the decrease in the intensity of the subsequent action does not follow the same law for all colours.

609. **Irradiation.**—This is a phenomenon in virtue of which white objects or those of a very bright colour, when seen on a dark ground, appear larger than they really are. Thus a white square upon a black ground seems larger than an exactly equal black square upon a white ground (fig. 501). Irradiation arises from the fact that the impression produced on the retina extends beyond the outline of the image. It bears the same relation to the space occupied by the image that the duration of the impression does to the time during which the image is seen.



Fig. 501.

The effect of irradiation is very perceptible in the apparent magnitude of stars, which may thus appear much larger than they really are; also in the appearance of the moon when two or three days old, the brightly illuminated crescent seeming to extend beyond the darker portion of the disc, and hold it in its grasp.

Plateau, who investigated this subject, found that irradiation differs very much in different people, and even in the same person it differs on different days. He also found that irradiation increases with the lustre of the object, and the length of time during which it is viewed. It manifests itself at all distances, diverging lenses increase and condensing lenses diminish it.

*Accidental haloes* are the colours which, instead of succeeding the impression of an object like accidental colours, appear round the object itself when it is looked at fixedly. The impression of the halo is the opposite to that of the object: if the object is bright the halo is dark, and *vice versa*. These appearances are best produced in the following manner. A white

surface, such as a sheet of paper, is illuminated by coloured light, and a narrow opaque body held so as to cut off some of the coloured rays. In this manner a narrow shadow is obtained which is illuminated by the surrounding white daylight, and appears complementary to the coloured ground. If red glass is used, the shadow appears green, and blue when a yellow glass is used.

The *contrast of colours* is a reciprocal action exerted between two adjacent colours, and in virtue of which to each one is added the complementary colour of the other. This contrast was studied by M. Chevreul, who found that when red and yellow colours are adjacent, red acquires a violet and yellow an orange tint. If the experiment is made with red and blue, the former acquires a yellow, and the latter a green tint : with yellow and blue, yellow passes to orange, and blue towards indigo : and so on for a vast number of combinations. The importance of this phenomenon in its application to the manufacture of cloths, carpets, curtains, etc., may be readily conceived.

610. **The eye is not achromatic.**—It had long been supposed that the human eye was perfectly achromatic, but this is clearly impossible, as all the refractions are made the same way, viz. towards the axis ; moreover, the experiments of Wollaston, of Young, of Fraunhofer, and of Müller, have shown that it was not true in any absolute sense.

Fraunhofer showed that in a telescope with two lenses, a very fine wire placed inside the instrument in the focus of the object glass is seen distinctly through the eyepiece, when the telescope is illuminated with red light ; but it is invisible by violet light even when the eyepiece is in the same position. In order to see the wire again, the distance of the lenses must be diminished to a far greater extent than would correspond to the degree of refrangibility of violet light in glass. In this case, therefore, the effect must be due to a chromatic aberration in the eye.

Müller, on looking at a white disc on a dark ground, found that the image is sharp when the eye is accommodated to the distance of the disc, that is, when the image forms on the retina ; but he found that if the image is formed in front of or behind the retina, the disc appears surrounded by a very narrow blue edge. If a finger be held up in front of one eye (the other being closed) in such a manner as to allow the light to enter only one-half of the pupil, and, of course, obliquely, and the eye be then directed to any well-defined line of light, such as a slit in the shutter of a darkened room, or a strip of white paper on a black ground, this line of light will appear as a complete spectrum.

Müller concluded from these experiments that the eye is sensibly achromatic as long as the image is received at the focal distance, or when it is accommodated to the distance of the object. The cause of this apparent achromatism cannot be exactly stated. It has generally been attributed to the tenuity of the luminous beams which pass through the pupillary aperture, and that these unequally refrangible rays, meeting the surfaces of the media of the eye almost at the normal incidence, are very little refracted, from which it follows that the chromatic aberration is imperceptible (566).

Spherical aberration, as we have already seen, is corrected by the iris

For objective representation the image of a slit in a dark shutter, through which the sunlight enters, is focussed by means of a convex lens on a screen at a distance, and then a grating is placed in the path of the rays.

There are many points of difference between these spectra and those produced by the prism, and for scientific work the former are preferable.

A diffraction spectrum is the purer the greater the number of lines in the grating, provided they are equidistant. The spectra are not more than  $\frac{1}{10}$  as bright as prismatic spectra; and to obtain the maximum brightness the opaque intervals should be as opaque and the transparent ones as transparent as possible.

On the other hand, in diffraction spectra, the colours are uniformly distributed in their true order and extent, while in prismatic spectra the red rays are concentrated, and the violet ones dispersed. In diffraction spectra the centre is the brightest part.

Diffraction spectra have, moreover, the advantage of giving a far larger number of dark lines, and of giving them in their exact relative positions. Thus, in a particular region in which Angström had mapped 118 lines, Draper, by means of a diffraction spectrum, was able to photograph at least 293. Diffraction spectra also extend further in the direction of the ultra-violet, and give more dark lines in that region.

631. **Determination of wave-length.**—The relative positions of these bright and dark lines furnish a means of calculating the wave-length or length of undulation of any particular colour. We must first of all know the distance  $rs$  of the first dark band from the bright one. The bands are not uniform in brightness or darkness, but there is in each case a position of maximum intensity, and it is from these that the distances are measured. If the bands are viewed through a telescope the angle is observed through which the axis must be turned from the position in which the cross wire coincides with the centre of the bright band to that in which it coincides with the centre of the dark band. From the angle, which can be very accurately measured, the distance is easily calculated. When the diffraction bands are received on a screen the distance may be directly measured, and most accurately by taking half the distance between the centres of the first pair of dark bands.

We have thus the similar triangles  $abc$ , and  $rds$ , in which  $ac : bc = rs : rd$ . Now  $bc$  may be taken equal to  $ab$ , the width of the slit, which can be measured directly with great accuracy by means of a micrometric screw (11), and  $rd$  is the distance of the screen. Hence

$$ac = \frac{rs \times ab}{rd}.$$

Now  $ac$ , the difference between  $as$  and  $sc$ , is equal to the length of an undulation of this particular colour. In one experiment with red light the width of the slit  $ab$  was 0.015 in., the distance  $rs$  0.15 in., and the distance of the screen 93 in., which gave  $ac = \frac{0.15 \times 0.015}{93} = 0.000024$  in. as the wave-length of red light. Using blue light the distance of  $rs$  was found to be 0.1, which gives 0.000016.

Knowing the length of the undulations, we can easily calculate their

number in a second,  $n$ , from the formula  $n = \frac{v}{\lambda}$  (228), where  $v$  is the velocity of light. Taking this at 186,000 miles, we get for the red corresponding to the dark line B 434,420,000,000,000 as the number of oscillations in a second, and for the H in the violet 758,840,000,000,000 undulations.

If, instead of a single slit, gratings be used, we have the possibility of far more accurate results, for the contrast is greater, and thus the distance is more easily determined. The breadth of the slit is then easily calculated if we know the number of lines in a given space.

632. **Colours of thin plates. Newton's rings.**—All transparent bodies, solids, liquids, or gases, when in sufficiently fine laminæ, appear coloured



Fig. 512.

with very bright tints, especially by reflection. Crystals which cleave easily, and can be obtained in very thin plates, such as mica and selenite, show this phenomenon, which is also well seen in soap-bubbles and in the layers of air in cracks in glass and in crystals. A drop of oil spread rapidly over a large sheet of water exhibits all the colours of the spectra in a constant order. A soap-bubble appears white at first, but, in proportion as it is blown out, brilliant iridescent colours appear, especially at the top, where it is thinnest. These colours are arranged in horizontal zones around the summit, which appears black when there is not thickness enough to reflect light, and the bubble then suddenly bursts.

Newton, who first studied the phenomena of the coloured rings in soap-bubbles, wishing to investigate the relation between the thickness of the thin plate, the colour of the rings, and their extent, produced them by means of a layer of air interposed between two glasses, one plane and the other convex, and with a very long focus (fig. 512). The two surfaces being cleaned and exposed to ordinary light in front of a window, so as to reflect light, there is seen at the point of contact a black spot surrounded by six or seven coloured rings, the tints of which become gradually less strong. If the glasses are viewed by transmitted light, the centre of the rings is white, and each of the colours is exactly complementary of that of the rings by reflection.

With homogeneous light, red for example, the rings are successively black and red; the diameters of corresponding rings are less as the colour is more refrangible, but with white light the rings are of the different colours of the spectrum, which arises from the fact that, as the rings of the different simple colours have different diameters, they are not exactly superposed, but are more or less separated.

If the focal length of the lens is from three to four yards, the rings can be seen with the naked eye; but if the length is less, the rings must be looked at with a lens.

633. **Explanation of Newton's rings.**—Newton's rings, and all phenomena of thin plates, are simple cases of interference.

In fig. 513, let MNOP represent a thin plate of a transparent body, on which a pencil of parallel rays of homogeneous light,  $ab$ , impinges; this will be partially reflected in the direction  $bc$ , and partially refracted towards  $d$ . But the refracted ray will undergo a second reflection at the surface, OP; the reflected ray will emerge at  $e$  in the same direction as the pencil of light reflected at the first surface; and consequently the two pencils  $bc$  and  $ef$  will destroy or augment each other's effect according as they are in the same or different phases. We shall thus have an effect produced similar to that of the fringes.

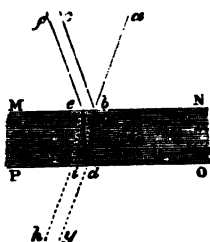

Fig. 513.

It is usual to speak of the successive rings as the first, second, third, etc. By the *first* ring is understood that of least diameter. Newton determined by calculation the thickness of the layer of air at the points where the successive rings were formed, and found that the thicknesses corresponding to the successive *dark* rings are proportional to the numbers 0, 2, 4, 6, . . . . ., while for the *bright* rings the thicknesses were proportional to 1, 3, 5 . . . . . He found that for the first bright ring the thickness was  $\frac{1}{178006}$  of an inch, when the light used was the brightest part of the spectrum, that is, the part on the confines of the orange and yellow rays. He further found that for rings of the same order the diameter is greater as the refrangibility of the light producing it is less.

#### POLARISATION OF LIGHT.

634. **Polarisation by double refraction.**—It has been already seen that, when a ray of light passes through a crystal of Iceland spar, it becomes divided into two rays of *equal intensity*, viz., the ordinary ray, and the extraordinary ray. These rays are found to possess other peculiarities, which are expressed by saying they are *polarised*, namely, the ordinary ray in a principal plane, and the extraordinary ray in a plane at right angles to a principal plane. The phenomena which are thus designated may be described as follows:—Suppose a ray of light which has undergone *ordinary* refraction in a crystal of Iceland spar to be allowed to pass through a second crystal, it will generally be divided into two rays, namely, one ordinary, and the other extraordinary, but of *unequal intensities*. If the second crystal be turned round until the two principal planes coincide, that is, until the crystals are in similar or in opposite positions, then the extraordinary ray disappears, and the ordinary ray is at its greatest intensity; if the second crystal is turned further round, the extraordinary ray reappears, and increases in intensity as the angle increases, while the ordinary ray diminishes in intensity until the principal planes are at right angles to each other, when the extraordinary ray is at its greatest intensity, and the ordinary ray vanishes. These are the phenomena produced when the ray which experienced ordinary refraction in the first crystal passes through the second. If the ray

which has experienced extraordinary refraction in the first crystal is allowed to pass through the second crystal, the phenomena are similar to those above described, but when the principal planes coincide, an extraordinary ray alone emerges from the second crystal, and when the planes are at right angles, an ordinary ray alone emerges.

These phenomena may also be thus described:—Let  $O$  and  $E$  denote the ordinary and extraordinary rays produced by the first crystal. When  $O$  enters the second crystal, it generally gives rise to two rays, an ordinary ( $Oo$ ), and an extraordinary ( $Oe$ ), of unequal intensities. When  $E$  enters the second crystal, it likewise gives rise to two rays, viz., an ordinary ( $Eo$ ) and an extraordinary ( $Ee$ ), of unequal intensities; the intensities varying with the angle between the principal planes of the crystals. When the principal planes coincide, only two rays, viz.,  $Oo$  and  $Ee$ , emerge from the second crystal, and when the planes are at right angles, only two rays, viz.  $Oe$  and  $Eo$ , emerge from the second crystal. Since  $O$  gives rise to an ordinary ray when the principal planes are parallel, and  $E$  gives rise to an ordinary ray when they are at right angles, it is manifest that  $O$  is related to the principal plane in the same manner that  $E$  is related to a plane at right angles to a principal plane.

This phenomenon, which is produced by all double refracting crystals, was observed by Huyghens in Iceland spar, and in consequence of a suggestion of Newton's was afterwards called *polarisation*. It remained, however, an isolated fact until the discovery of polarisation by reflection recalled the attention of physicists to the subject. The latter discovery was made by Malus in 1808.

635. **Polarisation by reflection.**—When a ray of light,  $ab$  (fig. 514), falls on a polished unsilvered glass surface,  $fghi$ , inclined to it at an angle of  $35^\circ 25'$ , it is reflected, and the reflected ray is polarised in the plane of reflection. If it were transmitted through a crystal of Iceland spar, it would be transmitted without bifurcation, and undergo an ordinary refraction, when the principal plane coincides with the plane of reflection; it would also be transmitted without bifurcation, but undergo extraordinary refraction, when the principal plane is at right angles to the plane of reflection: in other positions of the crystal it would give rise to an ordinary and an extraordinary ray of different intensities, according to the angle between the plane of reflection and the principal plane of the crystal. The peculiar property which the light has acquired by reflection at the surface  $fghi$  can also be exhibited as follows:—Let the polarised ray  $bc$  be received at  $c$ , on a second surface of unsilvered glass, at the same angle, viz.  $35^\circ 25'$ . If the surfaces are parallel, the ray is reflected: but if the second plate is caused to turn round  $cb$ , the intensity of the reflected ray continually diminishes, and when the glass surfaces are at right angles to each other, no light is reflected. By continuing to turn the upper

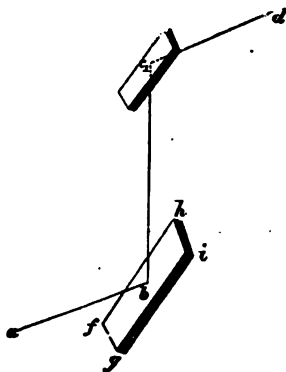

Fig. 514.

By continuing to turn the upper

graduated circle indicates the angle of inclination of the mirror. Between the feet of the two columns there is a silvered glass,  $p$ , which is fixed and horizontal. At the upper end of the columns there is a graduated plate,  $i$ , in which a circular disc,  $o$ , rotates. This disc, in which there is a square aperture, supports a mirror of black glass,  $m$ , which is inclined to the vertical at the polarising angle. An annular disc,  $k$ , can be fixed at different heights on the columns by means of a screw. A second ring,  $a$ , may be moved around the axis. It supports a black screen, in the centre of which there is a circular aperture.

When the mirror  $n$  makes with the vertical an angle of  $35^{\circ} 25'$ , which is the complement of the polarising angle for glass, the luminous rays,  $S_n$ , which meet the mirror at this angle, become polarised, and are reflected in the direction  $np$  towards the mirror  $p$ , which sends them in the direction  $pnr$ . After having passed through the glass,  $n$ , the polarised ray falls upon the blackened glass  $m$  under an angle of  $35^{\circ} 25'$ , because the mirror makes exactly the same angle with the vertical. But if the disc,  $o$ , to which the mirror,  $m$ , is fixed, be turned horizontally, the intensity of the light reflected from the upper mirror gradually diminishes, and totally disappears when it has been moved through  $90^{\circ}$ . The position is that represented in the diagram: the plane of incidence on the upper mirror is then perpendicular to the plane of incidence,  $Snp$ , on the mirror  $n$ . When the upper mirror is again turned, the intensity of the light increases until it has passed through  $180^{\circ}$ , when it again reaches a maximum. The mirrors  $m$  and  $n$  are then parallel. The same phenomena are repeated as the mirror  $m$  continues to be turned in the same direction, until it again comes into its original position; the intensity of the reflected light being greatest when the mirrors are parallel, and being reduced to zero when they are at right angles. If the mirror  $m$  is at a greater or less angle than  $35^{\circ} 25'$ , a certain quantity of light is reflected in all positions of the plane of incidence.

640. **Tourmaline.**—The primary form of this crystal is a regular hexagonal prism. Tourmaline, as already stated, is a negative uniaxial crystal, and its optic axis coincides with the axis of the prism. For optical purposes a plate is cut from it parallel to the axis. When a ray of light passes through such a plate, an ordinary ray and an extraordinary ray are produced polarised in planes at right angles to each other, viz. the former in a plane at right angles to the plate parallel to the axis, and the latter in a plane at right angles to the axis. The crystal possesses, however, the remarkable property of rapidly absorbing the ordinary ray; consequently, when a plate of a certain thickness is used, the extraordinary ray alone emerges—in other words, a beam of common light emerges from the plate of tourmaline polarised in a plane at right angles to the axis of the crystal. If the light thus transmitted be viewed through another similar plate held in a parallel position, little change will be observed excepting that the intensity of the transmitted light will be about equal to that which passes through a plate of double the thickness; but if the second tourmaline be slowly turned, the light will become feebler, and will ultimately disappear when the axes of the two plates are at right angles.

The objections to the use of the tourmaline are that it is not very transparent, and that plates of considerable thickness must be used if the polarisa-

angles to each other. It is, of course, to be understood that the polarised portion of the reflected light is polarised in the plane of reflection, which is likewise the plane of refraction.

638. **Polarising instruments.**—Every instrument for investigating the properties of polarised light consists essentially of two parts, one for polarising the light, the other for ascertaining or exhibiting the fact of light having undergone polarisation. The former part is called the polariser, the latter the analyser. Thus in art. 634 the crystal producing the first refraction is the *polariser*, that producing the second refraction is the *analyser*. In art. 635, the mirror at which the first reflection takes place is the polariser, that at which the second reflection takes place is the analyser. Some of the most convenient means of producing polarised light will now be described, and it will be remarked that any instrument that can be used as a polariser can also be used as an analyser. The experimenter has therefore considerable liberty of selection.

639. **Norremberg's apparatus**—The most simple but complete instrument for polarising light is that invented by Norremberg. It may be used for repeating most of the experiments on polarised light.

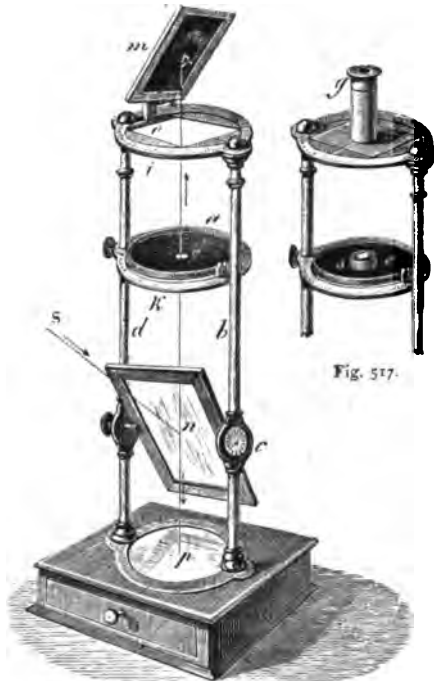

Fig. 516.

It consists of two brass rods *b* and *d* (fig. 516), which support an unsilvered mirror, *n*, of ordinary glass, movable about a horizontal axis. A small



graduated circle indicates the angle of inclination of the mirror. Between the feet of the two columns there is a silvered glass,  $\beta$ , which is fixed and horizontal. At the upper end of the columns there is a graduated plate,  $i$ , in which a circular disc,  $o$ , rotates. This disc, in which there is a square aperture, supports a mirror of black glass,  $m$ , which is inclined to the vertical at the polarising angle. An annular disc,  $k$ , can be fixed at different heights on the columns by means of a screw. A second ring,  $a$ , may be moved around the axis. It supports a black screen, in the centre of which there is a circular aperture.

When the mirror  $n$  makes with the vertical an angle of  $35^\circ 25'$ , which is the complement of the polarising angle for glass, the luminous rays,  $Sn$ , which meet the mirror at this angle, become polarised, and are reflected in the direction  $n\beta$  towards the mirror  $\beta$ , which sends them in the direction  $\beta nr$ . After having passed through the glass,  $n$ , the polarised ray falls upon the blackened glass  $m$  under an angle of  $35^\circ 25'$ , because the mirror makes exactly the same angle with the vertical. But if the disc,  $o$ , to which the mirror,  $m$ , is fixed, be turned horizontally, the intensity of the light reflected from the upper mirror gradually diminishes, and totally disappears when it has been moved through  $90^\circ$ . The position is that represented in the diagram: the plane of incidence on the upper mirror is then perpendicular to the plane of incidence,  $Sn\beta$ , on the mirror  $n$ . When the upper mirror is again turned, the intensity of the light increases until it has passed through  $180^\circ$ , when it again reaches a maximum. The mirrors  $m$  and  $n$  are then parallel. The same phenomena are repeated as the mirror  $m$  continues to be turned in the same direction, until it again comes into its original position; the intensity of the reflected light being greatest when the mirrors are parallel, and being reduced to zero when they are at right angles. If the mirror  $m$  is at a greater or less angle than  $35^\circ 25'$ , a certain quantity of light is reflected in all positions of the plane of incidence.

640. **Tourmaline.**—The primary form of this crystal is a regular hexagonal prism. Tourmaline, as already stated, is a negative uniaxial crystal, and its optic axis coincides with the axis of the prism. For optical purposes a plate is cut from it parallel to the axis. When a ray of light passes through such a plate, an ordinary ray and an extraordinary ray are produced polarised in planes at right angles to each other, viz. the former in a plane at right angles to the plate parallel to the axis, and the latter in a plane at right angles to the axis. The crystal possesses, however, the remarkable property of rapidly absorbing the ordinary ray; consequently, when a plate of a certain thickness is used, the extraordinary ray alone emerges—in other words, a beam of common light emerges from the plate of tourmaline polarised in a plane at right angles to the axis of the crystal. If the light thus transmitted be viewed through another similar plate held in a parallel position, little change will be observed excepting that the intensity of the transmitted light will be about equal to that which passes through a plate of double the thickness; but if the second tourmaline be slowly turned, the light will become feebler, and will ultimately disappear when the axes of the two plates are at right angles.

The objections to the use of the tourmaline are that it is not very transparent, and that plates of considerable thickness must be used if the polarisa-

tion is to be complete. For unless the ordinary ray is completely absorbed, the emergent light will be only partially polarised.

Herapath discovered that sulphate of iodoquinine has the property of polarising light in a remarkable degree. Unfortunately, it is a very fragile salt and difficult to obtain in large crystals.

641. **Double refracting prisms of Iceland spar.**—When a ray of light passes through an ordinary rhombohedron of Iceland spar, the ordinary and extraordinary rays emerge parallel to the original ray, consequently the separation of the rays is proportional to the thickness of the prism. But if the crystal is cut so that its faces are inclined to each other, the deviations of the ordinary and extraordinary rays will be different, they will not emerge parallel, and their separation will be greater as their distance from the prism increases. The light, however, in passing through the prism becomes decomposed, and the rays will be coloured. It is therefore necessary to achromatise the prism, which is done by combining it with a prism of glass with its refracting angle turned in the contrary direction (fig. 518). In order to obtain the greatest amount of divergence, the refracting edges of the prism should be cut parallel to the optic axis, and this is always done.

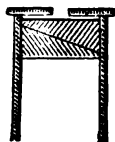

Fig. 518.

Let us suppose that a ray of polarised light passes along the axis of the cylinder (fig. 518), and let us suppose that the cylinder is caused to turn slowly round its axis; then the resulting phenomena are exactly like those already described (634). Generally there will be an ordinary and extraordinary ray produced, whose relative intensities will vary as the tube is turned. But in two opposite positions the ordinary ray alone will emerge, and in two others at right angles to the former the extraordinary ray will alone emerge. When the ordinary ray alone emerges, the principal plane of the crystal—that is, a plane at right angles to its face, and parallel to its refracting edge—coincides with the original plane of polarisation of the ray. Consequently, by means of the prism, it can be ascertained both that the ray is polarised, and likewise the plane in which it is polarised.

642. **Nicol's prism.**—The Nicol's prism is one of the most valuable means of polarising light, for it is perfectly colourless, it polarises light com-



Fig. 519.

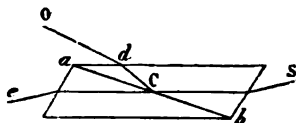

Fig. 520.

pletely, and it transmits only one beam of polarised light, the other being entirely suppressed.

It is constructed out of a rhombohedron of Iceland spar, about an inch in height and  $\frac{1}{3}$  of an inch in breadth. This is bisected in the plane which passes through the obtuse angles as shown in fig. 520—that is, along the plane *abcd* (fig. 507). The two halves are then again joined in the same order by means of Canada balsam.

The principle of the Nicol's prism is this : the refractive index of Canada balsam, 1.549, is less than the ordinary index of Iceland spar 1.654, but greater than its extraordinary index 1.483. Hence, when a luminous ray, SC, fig. 520, enters the prism, the ordinary ray undergoes total reflection on the surface *ab*, and takes the direction *CdO*, by which it is refracted out of the crystal ; while the extraordinary ray, *Ce*, emerges alone. Since the Nicol's prism allows only the extraordinary ray to pass, it may be used, like a tourmaline, as an analyser or as a polariser.

643. **Physical theory of polarised light.**—The explanation of the dark bands produced by the interference of light is stated in art. 627 to resemble exactly that of the formation of nodes and loops given in art. 269.

It might hence be supposed that the vibrations producing light are quite similar to those producing sound. But this is by no means the case. In fact, no assumption is made in art. 634 as to the *direction* in which the vibrating particles move, and accordingly the explanation is equally true whether the particles vibrate in the direction AB, BA, or at right angles to AB. As a matter of fact, the former is the case with the vibrations producing sound, the latter with the vibrations producing light. In other words, the vibrations producing sound take place in the direction of propagation, the vibrations producing light are *transversal* to the direction of propagation.

This assumption as to the direction of the vibration of the particles of ether producing light is rendered necessary, and is justified by the phenomena of polarisation.

When a ray of light is polarised, all the particles of ether in that ray vibrate in straight lines parallel to a certain direction in the front of the wave corresponding to the ray.

When a ray of light enters a double refracting medium, such as Iceland spar, it becomes divided into two, as we have already seen. Now it can be shown to be in strict accordance with mechanical principles that, if a medium possesses unequal elasticity in different directions, a plane wave produced by transversal vibrations entering that medium will give rise to two plane waves moving with different velocities within the medium, and the vibrations of the particles in front of these waves will be in directions parallel respectively to two lines at right angles to each other. If, as is assumed in the undulatory theory of light, the ether exists in a double refracting crystal in such a state of unequal elasticity, then the two plane waves will be formed as above described, and these, having different velocities, will give rise to two rays of unequal refrangibility (compare art. 620). This is the physical account of the phenomenon of double refraction. It will be remarked that the vibrations corresponding to the two rays are transversal, rectilinear, and in directions perpendicular to each other in the rays respectively. Accordingly the same theory accounts for the fact that the two rays are both polarised, and in planes at right angles to each other.

It is a point still unsettled whether, when a ray of light is polarised with respect to a given plane, the vibrations take place in directions within or perpendicular to that plane. Fresnel was of the latter opinion. It is, however, convenient in some cases to regard the plane of polarisation as that plane in which the vibrations take place.

## COLOURS PRODUCED BY THE INTERFERENCE OF POLARISED LIGHT.

644. **Laws of the interference of polarised rays.**—After the discovery of polarisation, Fresnel and Arago tried whether polarised rays presented the same phenomena of interference as ordinary rays. They were thus led to the discovery of the following laws in reference to the interference of polarised light, and at the same time, of the brilliant phenomena of coloration, which will be presently described :—

I. When two rays polarised in the same plane interfere with each other, they produce by their interference fringes of the very same kind as if they were common light.

II. When two rays of light are polarised at right angles to each other, they produce no coloured fringes in the same circumstances under which two rays of common light would produce them. When the rays are polarised in planes inclined to each other at any other angles, they produce fringes of intermediate brightness, and if the angle is made to change, the fringes gradually decrease in brightness from  $0^\circ$  to  $90^\circ$ , and are totally obliterated at the latter angle.

III. Two rays originally polarised in planes at right angles to each other may be subsequently brought into the same plane of polarisation without acquiring the power of forming fringes by their interference.

IV. Two rays polarised at right angles to each other, and afterwards brought into the same plane of polarisation, produce fringes by their interference like rays of common light, provided they originated in a pencil the whole of which was originally polarised in any one plane.

V. In the phenomena of interference produced by rays that have suffered double refraction, a difference of half an undulation must be allowed, as one of the pencils is retarded by that quantity from some unknown cause.

645. **Effect produced by causing a pencil of polarised rays to traverse a double refracting crystal.**—The following important experiment may be made most conveniently by Norremberg's apparatus (fig. 516). At *g* (fig. 517) there is a Nicol's prism. A plate of a double refracting crystal cut parallel to its axis is placed on the disc at *e*. In the first place, however, suppose the plate of the crystal to be removed. Then, since the Nicol's prism allows only the extraordinary ray to pass when it is turned so that its principal plane coincides with the plane of reflection, no light will be transmitted (642). Place the plate of doubly refracting crystal, which is supposed to be of moderate thickness, in the path of the reflected ray at *e*. Light is now transmitted through the Nicol's prism. On turning the plate, the intensity of the transmitted light varies; it reaches its maximum when the principal plane of the plate is inclined at an angle of  $45^\circ$  to the plane of reflection, and disappears when these planes either coincide with or are at right angles to each other. The light in this case is white. The interposed plate may be called the *depolarising plate*. The same or equivalent phenomena are produced when any other analyser is used. Thus, assume the double refracting prism to be used. Suppose the depolarising plate to be removed. Then, generally, two rays are transmitted; but if the principal

plane of the analyser is turned into the plane of primitive polarisation, the ordinary ray only is transmitted, and then, when turned through  $90^\circ$ , the extraordinary ray only is transmitted. Let the analyser be turned into the former position, then, when the depolarising plate is interposed, both ordinary and extraordinary rays are seen, and when the depolarising plate is slowly turned round, the ordinary and extraordinary rays are seen to vary in intensity, the latter vanishing when the principal plane of the polarising plate either coincides with or is at right angles to the plane of primitive polarisation.

646. **Effect produced when the plate of crystal is very thin.**—In order to exhibit this, take a thin film of *selenite* or *mica* between the twentieth and sixtieth of an inch thick, and interpose it as in the last article. If the thickness of the film is uniform, the light now transmitted through the analyser will be no longer white, but of a uniform tint; the colour of the tint being different for different thicknesses—for instance, red, or green, or blue, or yellow, according to the thickness; the intensity of the colour depending on the inclination of the principal plane of the film to the plane of reflection, being greatest when the angle of inclination is  $45^\circ$ . Let us now suppose the crystalline film to be fixed in that position in which the light is brightest, and suppose its colour to be *red*. Let the analyser (the Nicol's prism) be turned round, the colour will grow fainter, and when it has been turned through  $45^\circ$ , the colour disappears, and no light is transmitted; on turning it farther, the complementary colour, *green*, makes its appearance, and increases in intensity until the analyser has been turned through  $90^\circ$ ; after which the intensity diminishes until an angle of  $135^\circ$  is attained, when the light again vanishes, and, on increasing the angle, it changes again into red. Whatever be the colour proper to the plate, the same series of phenomena will be observed, the colour passing into its complementary when the analyser is turned. That the colours are really complementary is proved by using a double refracting prism as analyser. In this case two rays are transmitted, each of which goes through the same changes of colour and intensity as the single ray described above; but whatever be the colour and intensity of the one ray in a given position, the other ray will have the same when the analyser has been turned through an angle of  $90^\circ$ . Consequently, these two rays give simultaneously the appearances which are successively presented in the above case by the same ray at an interval of  $90^\circ$ . If now the two rays are allowed to overlap, they produce white light; thereby proving their colours to be complementary.

Instead of using plates of different thickness to produce different tints, the same plate may be employed inclined at different angles to the polarised ray. This causes the ray to traverse the film obliquely, and, in fact, amounts to an alteration in its thickness.

With the same substance, but with plates of increasing thickness, the tints follow the laws of the colours of Newton's rings (632). The thickness of the depolarising plate must, however, be different from that of the layer of air in the case of Newton's rings to produce corresponding colours. Thus corresponding colours are produced by a plate of mica and a layer of air when the thickness of the former is about 400 times that of the latter. In the case of selenite the thickness is about 230 times, and

in the case of Iceland spar about 13 times, that of the corresponding layer of air.

647. **Theory of the phenomena of depolarisation.**—The phenomena described in the last articles admit of complete explanation by the undulatory theory, but not without the aid of abstruse mathematical calculations. What follows will show the nature of the explanation. Let us suppose, for convenience, that in the case of a polarised ray the particles of ether vibrate in the plane of polarisation (see art. 643), and that the analyser is a double refracting prism, with its principal plane in the plane of primitive polarisation; then the vibrations being wholly in that plane have no resolved part in a plane at right angles to it, and, consequently, no extraordinary ray passes through the analyser; in other words, only an ordinary ray passes. Now take the depolarising plate cut parallel to the axis, and let it be interposed in a manner that its principal plane makes any angle ( $\theta$ ) with the plane of primitive polarisation. The effect of this will be to cause the vibrations of the primitive ray to be resolved in the principal plane, and at right angles to the principal plane, thereby giving rise to an ordinary ray (O), and an extraordinary ray (E), which, however, do not become separated on account of the thinness of the depolarising plate. They will not form a single plane polarised ray on leaving the plate, since they are unequally retarded in passing through it, and consequently leave it in different phases. Since neither of the planes of polarisation of O and E coincides with the principal plane of the analyser, the vibrations composing them will again be resolved by the analyser into vibrations in and at right angles to the principal plane—viz. O gives rise to  $O_o$  and  $O_e$ , and E gives rise to  $E_o$  and  $E_e$ . But the single ordinary ray,  $I_o$ , and in like manner  $O_e$  and  $E_e$  give rise to a single extraordinary ray,  $I_e$ . Thus the interposition of the depolarising plate restores the extraordinary ray.

Suppose the angle  $\theta$  to be either  $0^\circ$  or  $90^\circ$ . In either case the vibrations are transmitted through the depolarising plate without resolution, consequently they remain wholly in the plane of primitive polarisation, and on entering the analyser cannot give rise to an extraordinary ray.

If the Nicol's prism is used as an analyser, the ordinary ray is suppressed by mechanical means. Consequently only  $I_e$  will pass through the prism, and that for all values of  $\theta$  except  $0^\circ$  and  $90^\circ$ .

A little consideration will show that the joint intensities of all the rays existing at any stage of the above transformations must continue constant, but that the intensities of the individual rays will depend on the magnitude of  $\theta$ , and when this circumstance is examined in detail, it explains the fact that  $I_e$  increases in intensity as  $\theta$  increases from  $0^\circ$  to  $45^\circ$ , and then decreases in intensity as  $\theta$  increases from  $45^\circ$  to  $90^\circ$ .

In regard to the colour of the rays, it is to be observed that the formulæ for the intensities of  $I_o$  and  $I_e$  contain a term depending on the length of the wave and the thickness of the plate. Consequently, when white light is used, the relative intensities of its component colours are changed, and, therefore,  $I_o$  and  $I_e$  will each have a prevailing tint, which will be different for different thicknesses of the plate. The tints will, however, be complementary, since, the joint intensities of  $I_o$  and  $I_e$  being the same as that of the original ray,

they will, when superimposed, restore all the components of that ray in their original intensities, and therefore produce white light.

648. **Coloured rings produced by polarised light in traversing double refracting films.**—In the experiments with Norremberg's apparatus which have just been described (639), a pencil of parallel rays traverses the film of



Fig. 521.

crystal perpendicularly to its faces, and as all parts of the film act in the same manner, there is everywhere the same tint. But when the incident rays traverse the plate under different obliquities, which comes to the same thing as if they traversed plates differing in thickness, coloured rings are formed similar to Newton's rings.

The best method of observing these new phenomena is by means of the *tourmaline pincette*. This is a small instrument consisting of two tourmalines, cut parallel to the axis, each of them being fitted in a copper disc. These two discs, which are perforated in the centre, and blackened, are mounted in two rings of silvered copper, which is coiled, as shown in the figure, so as to form a spring, and press together the tourmalines. The tourmalines turn with the disc, and may be so arranged that their axes are either perpendicular or parallel.

The crystal to be experimented upon being fixed in the centre of a cork disc, is placed between the two tourmalines, and the pincette is held before the eye so as to view diffused light. The tourmaline farthest from the eye acts as polariser, and the other as analyser. If the crystal thus viewed is uniaxial, and cut perpendicularly to the axis, and a homogeneous light—red, for instance—is looked at, a series of alternately dark and red rings are seen. With another simple colour similar rings are obtained, but their diameter decreases with the refrangibility of the colour. On the other hand, the diameters of the rings diminish when the thickness of the plates increases, and beyond a certain thickness no more rings are produced. If, instead of illuminating the rings by homogeneous light, white light be used, as the rings of the different colours produced have not the same diameter, they are partially superposed, and produce very brilliant variegated colours.

The position of the crystal has no influence on the rings, but this is not the case with the relative position of the two tourmalines. For instance, in experimenting on Iceland spar cut perpendicular to the axis, and from 1 to 20 millimetres in thickness, when the axes of the tourmalines are perpendicular, a beautiful series of rings is seen brilliantly coloured, and traversed by a black cross, as shown in fig. 1, Plate II. If the axes of the tourmalines are parallel, the rings have tints complementary to those they had at first, and there is a white cross (fig. 11, Plate II.), instead of a black one.

In order to understand the formation of these rings when polarised light

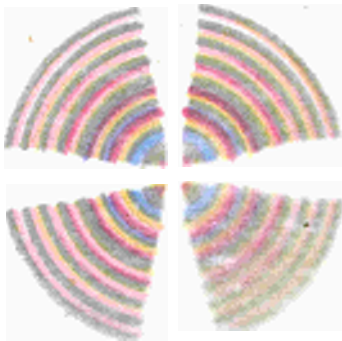
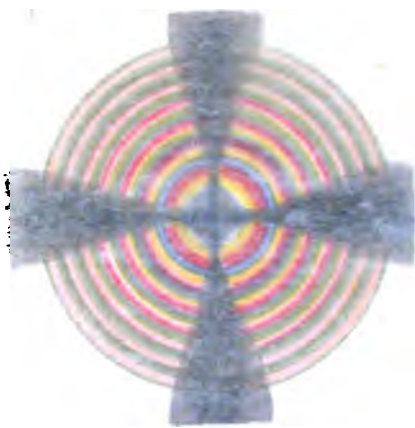





I



IV



II

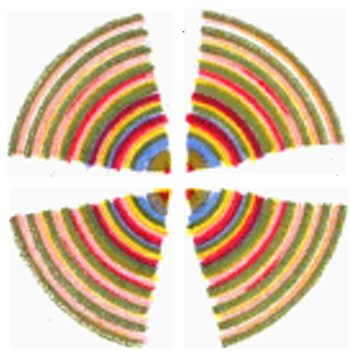

V



III



VI

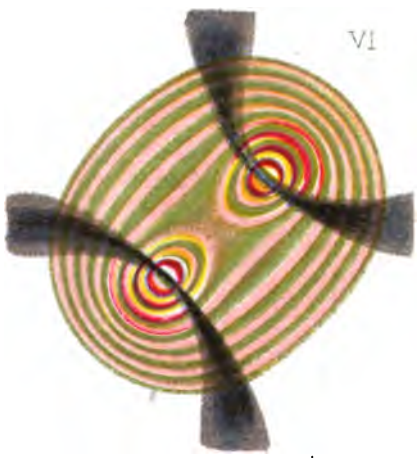

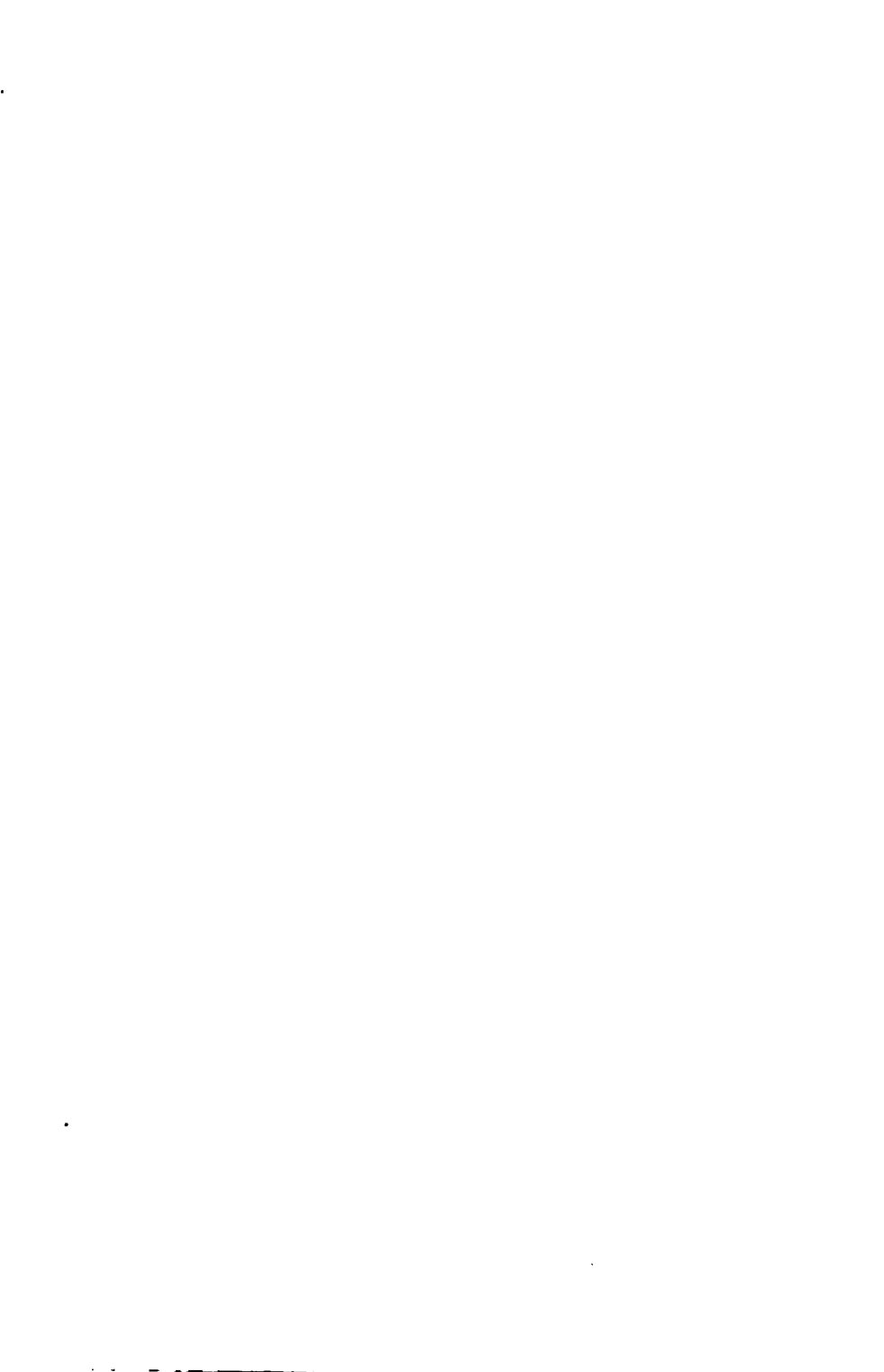

traverses double refracting films, it must first be premised that these films are traversed by a converging conical pencil, whose summit is the eye of the observer. Hence it follows that the virtual thickness of the film which the rays traverse increases with their divergence; but for rays of the same obliquity this thickness is the same; hence there result different degrees of retardation of the ordinary with respect to the extraordinary ray at different points of the plate, and consequently different colours are produced at different distances from the axis, but the same colours will be produced at the same distance from the axis, and consequently the colours are arranged in circles round the axis. The arms of the black cross are parallel to the optic axis of each of the tourmalines, and are due to an absorption of the polarised light in these directions. When the tourmalines are parallel the vibrations are transmitted, and hence the white cross.

Analogous effects are produced with all uniaxial crystals; for instance, tourmaline, emerald, sapphire, beryl, mica, pyromorphite, and ferrocyanide of potassium.

649. **Rings in biaxial crystals.**—In biaxial crystals, coloured rings are also produced, but their form is more complicated. The coloured bands, instead of being circular and concentric, have the form of curves, with two centres, the centre of each system corresponding to an axis of the crystal. Figs. 4, 5, and 6, Plate II., represent the curves seen when a plate of either cerussite, topaz, or nitre, cut perpendicularly to the axis, is placed between the two tourmalines, the plane containing the axis of the crystal being in the plane of primitive polarisation. When the axes of the two tourmalines are at right angles to each other, fig. 4, Plate II. is obtained. On turning the crystal without altering the tourmalines, fig. 5, Plate II. is seen, which changes into fig. 6, Plate II. when the crystal has been turned through  $45^\circ$ . If the axes of the tourmalines are parallel, the same coloured curves are obtained, but the colours are complementary, and the black cross changes into white. The angle of the optic axis in the case of nitre is only  $5^\circ 20'$ , and hence the whole system can be seen at once. But when the angle exceeds  $20^\circ$  to  $25^\circ$ , the two systems of curves cannot be simultaneously seen. There is then only one dark bar instead of the cross, and the bands are not oval, but circular. Fig. 3, Plate II., represents the phenomenon as seen with aragonite.

Herschel, who has carefully measured the rings produced by biaxial crystals, refers them to the kind of curve known in geometry as the *lemniscate*, in strict accordance with the principles of the undulatory theory of light.

The observation of the system of rings which plates of crystals give in polarised light presents a means of distinguishing between optical uniaxial and optical biaxial crystals, even in cases in which no conclusion can be drawn as to the system in which a mineral crystallises from mere morphological reasons. In this way, the optical investigation becomes a valuable aid in mineralogy, as, for example, in the case of mica, of which there are two mineralogical species, the uniaxial and the biaxial.

All the phenomena which have been described are only obtained by means of polarised light. Hence, a double refracting film, with either a

Nicol's prism or a tourmaline as analyser, may be used to distinguish between polarised and unpolarised light—that is, as a polariscope.

650. **Colours produced by compressed or by unannealed glass.**—Ordinary glass is not endowed with the power of double refraction. It acquires this property, however, if by any cause its elasticity becomes more modified in one direction than in another. In order to effect this, it may

Fig. 522.

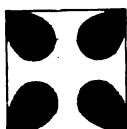

Fig. 523.

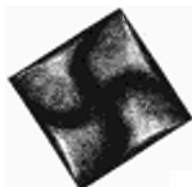

Fig. 524.



Fig. 525.



Fig. 526.



Fig. 527.

be strongly compressed in a given direction, or it may be curved, or tempered—that is to say, cooled after having been heated. If the glass is then traversed by a beam of polarised light, effects of colour are obtained which are entirely analogous to those described in the case of doubly refracting crystals. They are, however, susceptible of far greater variety, according as the plates of glass have a circular, square, rectangular, or triangular shape, and according to the degree of tension of their particles.

When the polariser is a mirror of black glass, on which the light of the sky is incident, and the analyser is a Nicol's prism, through which the glass plates traversed by polarised light are viewed, figs. 522, 523, 525, represent the appearances presented successively, when a square plate of compressed glass is turned in its own plane; figs. 524 and 527 represent the appearances produced by a circular plate under the same circumstances; and fig. 526, that produced when one rectangular plate is superposed on another. This figure also varies when the system of plates is turned.

## ELLIPTICAL, CIRCULAR, AND ROTATORY POLARISATION.

651. **Definition of elliptical and circular polarisation.**—In the cases hitherto considered the particles of ether composing a polarised ray vibrate in parallel straight lines; to distinguish this case from those we are now to consider, such light is frequently called *plane polarised light*. It sometimes happens that the particles of ether describe *ellipses* round their positions of rest, the planes of the ellipses being perpendicular to the direction of the ray. If the axes of these ellipses are equal and parallel, the ray is said to be *elliptically polarised*. In this case the particles which, when at rest, occupied a straight line, are, when in motion, arranged in a helix round the line of their original position as an axis, the helix exchanging from instant to instant. If the axes of the ellipses are equal, they become circles, and the light is said to be *circularly polarised*. If the minor axes become zero, the ellipses coincide with their major axes, and the light becomes *plane polarised*. Consequently, *plane polarised light* and *circularly polarised light* are particular cases of elliptically polarised light.

652. **Theory of the origin of elliptical and circular polarisation.**—Let us in the first place consider a simple pendulum (55) vibrating in any plane, the arc of vibration being small. Suppose that, when in its lowest position, it received a blow in a direction at right angles to the direction of its motion, such as would make it vibrate in an arc at right angles to its arc of primitive vibration, it follows from the law of the composition of velocities (52) that the joint effect will be to make it vibrate in an arc inclined at a certain angle to the arc of primitive vibration, the magnitude of the angle depending on the magnitude of the blow. If the blow communicated a velocity equal to that with which the body is already moving, the angle would be  $45^\circ$ . Next suppose the blow to communicate an equal velocity, but to be struck when the body is at its highest point, this will cause the particle to describe a circle, and to move as a conical pendulum (57). If the blow is struck under any other circumstances, the particle will describe an ellipse. Now as the two blows would produce separately two simple vibrations in directions at right angles to each other, we may state the result arrived at as follows:—If two rectilinear vibrations are superinduced on the same particle in directions at right angles to each other, then: 1. If they are in the same and opposite phases, they make the point describe a rectilinear vibration in a direction inclined at a certain angle to either of the original vibrations. 2. But if their phases differ by  $90^\circ$  or a quarter of a vibration, the particle will describe a circle, provided the vibrations are equal. 3. Under other circumstances the particle will describe an ellipse.

To apply this to the case of polarised light. Suppose two rays of light polarised in perpendicular planes to coincide, each would separately cause the same particles to vibrate in perpendicular directions. Consequently—1. If the vibrations are in the same or opposite phases, the light resulting from the two rays is plane polarised. 2. If the rays are of equal intensity, and their phases differ by  $90^\circ$ , the resulting light is circularly polarised. 3. Under other circumstances the light is elliptically polarised.

As an example, if reference is made to arts. 658 and 659, it will be seen

that the rays denoted by O and E are superimposed in the manner above described. Consequently, the light which leaves the depolarising plate is elliptically polarised. If, however, the principal plane of the depolarising plate is turned so as to make an angle of  $45^\circ$  with the plane of primitive polarisation, O and E have equal intensities; and if, further, the plate is made of a certain thickness, so that the phases of O and E may differ by  $90^\circ$ , or by a quarter of a vibration, the light which emerges from the plate is circularly polarised. This method may be employed to produce circularly polarised light.

Circular or elliptical polarisation may be either *right-handed* or *left-handed*, or what is sometimes called *dextrogyrate* and *lævogyrate*. If the observer looks along the ray in the direction of propagation, from polariser to analyser, then, if the particles move in the same direction as the hands of a watch with its face to the observer, the polarisation is right-handed.

653. **Fresnel's rhomb.**—This is a means of obtaining circularly polarised light. We have already seen (652) that, to obtain a ray of circularly polarised light, it is sufficient to decompose a ray of plane polarised light in such a manner as to produce two rays of light of equal intensity polarised in planes at right angles to each other, and differing in their paths by a quarter of an undulation. Fresnel effected this by means of a rhomb, which has received his name. It is made of glass; its acute angle is  $54^\circ$ , and its obtuse  $126^\circ$ . If a ray, *a*, fig. 528, of plane polarised light falls perpendicularly on the face AB, it will undergo two total internal reflections at an angle of about  $54^\circ$ , one at E, and the other at F, and will emerge perpendicularly.

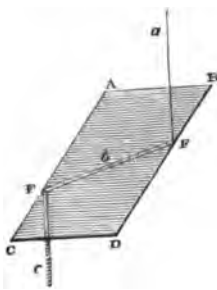

Fig. 528.

If the plane ABCD be inclined at an angle of  $45^\circ$  to the plane of polarisation, the polarised ray will be divided into two coincident rays, with their planes of polarisation at right angles to each other, and it appears that one of them loses exactly a quarter of an undulation, so that on emerging from the rhomb the ray is circularly polarised. If the ray emerging as above from Fresnel's rhomb is examined, it will be found to differ from plane polarised light in this, that, when it passes through a double refracting prism, the ordinary and extraordinary rays are of equal intensity in all positions of the prism. Moreover, it differs from ordinary light in this, that if it passed through a second rhomb placed parallel to the first, a second quarter of an undulation will be lost, so that the parts of the original plane polarised ray will differ by half an undulation, and the emergent ray will be plane polarised; moreover, the plane of polarisation will be inclined at an angle of  $45^\circ$  to ABCD, but on the *other side* of the plane of primitive polarisation.

654. **Elliptical polarisation.**—In addition to the method already mentioned (653), elliptically polarised light is generally obtained whenever plane polarised light suffers reflection. Polarised light reflected from metals

becomes elliptically polarised, the degree of ellipticity depending on the direction of the incident ray, and of its plane of polarisation, as well as on the reflecting substance. When reflected from silver, the polarisation is almost circular, and from galena almost plane. If elliptically polarised light be analysed by the Nicol's prism, it never vanishes, though at alternate positions it becomes fainter; it is thus distinguished from plane and from circular polarised light. If analysed by Iceland spar neither image disappears, but they undergo changes in intensity.

Light can also be polarised elliptically in Fresnel's rhomb. If the angle between the planes of primitive polarisation and of incidence be any other than  $45^\circ$ , the emergent ray is elliptically polarised.

655. **Rotatory polarisation.**—Rock crystal or quartz possesses a remarkable property which was long regarded as peculiar to itself among all crystals, though it has been since found to be shared by tartaric acid and its salts, together with some other crystalline bodies. This property is called rotatory polarisation, and may be described as follows:—Let a ray of homogeneous light be polarised and let the analyser, say a Nicol's prism, be turned till the light does not pass through it. Take a thin section of a quartz crystal cut at right angles to its axis, and place it between the polariser and the analyser with its plane at right angles to the rays. The light will now pass through the analyser. The phenomenon is not the same as that previously described (645), for, if the rock crystal is turned round its axis, no effect is produced, and if the analyser is turned, the ray is found to be *plane polarised* in a plane inclined at a certain angle to the plane of primitive polarisation. If the light is red, and the plate 1 millimetre thick, this angle is about  $17^\circ$ . In some specimens of quartz the plane of polarisation is turned to the right hand, in others to the left hand. Specimens of the former kind are said to be right-handed, those of the latter kind left-handed. This difference corresponds to a difference in crystallographic structure. The property possessed by rock crystal of turning the plane of polarisation through a certain angle was thoroughly investigated by M. Biot, who, amongst other results, arrived at this:—For a given colour the angle through which the plane of polarisation is turned is proportional to the thickness of the quartz.

656. **Physical explanation of rotatory polarisation.**—The explanation of the phenomenon described in the last article is as follows:—When a ray of polarised light passes along the axis of the quartz crystal, it is divided into two rays of *circularly* polarised light of equal intensity, which pass through the crystal with different velocities. In one the circular polarisation is right-handed, in the other left-handed (652). The existence of these rays was proved by Fresnel, who succeeded in separating them. On emerging from the crystal, they are compounded into a plane polarised ray, but since they move with unequal velocities within the crystal, they emerge in different phases, and consequently the plane of polarisation will not coincide with the plane of primitive polarisation. This can be readily shown by reasoning similar to that employed in art. 652. The same reasoning will also show that the plane of polarisation will be turned to the right or left, according as the right-handed or left-handed ray moves with the greater velocity. Moreover, the amount of the rotation will depend on the amount of the



retardation of the ray whose velocity is least—that is to say, it will depend on the thickness of the plate of quartz. In this manner the phenomena of rotatory polarisation can be completely accounted for.

657. **Coloration produced by rotatory polarisation.**—The rotation is different with different colours ; its magnitude depends on the refrangibility, and is greatest with the most refrangible rays. In the case of red light a plate 1 millimetre in thickness will rotate the plane  $17^\circ$ , while a plate of the same thickness will rotate it  $44^\circ$  in the case of violet light. Hence with white light there will, in each position of the analysing Nicol's prism, be a greater or less quantity of each colour transmitted. In the case of a right-handed crystal, when the Nicol's prism is turned to the right, the colours will successively appear from the less refrangible to the more so—that is, in the order of the spectrum, from red to violet ; with a left-handed crystal in the reverse order. Obviously in turning the Nicol's prism to the left, the reverse of these results will take place.

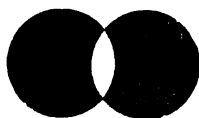

Fig. 529.

When a quartz plate cut perpendicularly to the axis and traversed by a ray of polarised light is looked at through a doubly refracting prism, two brilliantly coloured images are seen, of which the tints are complementary : for their images are partially superposed, and in this position there is a white light (fig. 529). When the prism is turned from left to right, the two images change colour and assume successively all the colours of the spectrum.

This will be understood from what has been said about the different rotation for different colours. Quartz rotates the plane of polarisation for red  $17^\circ$  for each millimetre, and for violet  $44^\circ$  ; hence, from the great difference of these two angles, when the polarised light which has traversed the quartz plate emerges, the various simple colours which it contains are polarised in different planes. Consequently, when the rays thus transmitted by the quartz pass through a double refracting prism, they are each decomposed into two others polarised at right angles to each other : the various simple colours are not divided in the same proportion between the ordinary and extraordinary rays furnished by the prism ; the two images are, therefore, coloured ; but, since those which are wanting in one occur in the other, the colours of the images are perfectly complementary.

These phenomena of coloration may be well seen by means of Norremberg's apparatus (fig. 517). A quartz plate, *s*, cut at right angles to the axis and fixed in a cork disc, is placed on a screen, *e* ; the mirror, *n* (fig. 517), being then so inclined that a ray of polarised light passes through the quartz, the latter is viewed through a refracting prism, *g* ; when this tube is turned the complementary images furnished by the passage of polarised light through the quartz are seen.

658. **Rotatory power of liquids.**—Biot found that a great number of liquids and solutions possess the property of rotatory polarisation. He further observed that the deviation of the plane of polarisation can reveal differences in the composition of bodies where none is exhibited by chemical analysis. For instance, uncrystallisable grape-sugar deflects the plane of

polarisation to the left, while cane-sugar deflects it to the right, although the chemical composition of the two sugars is the same.

The rotatory power of liquids is far less than that of quartz. In concentrated syrup of cane-sugar, which possesses the rotatory power in the highest degree, the power is  $\frac{1}{36}$ th that of quartz, so that it is necessary to operate upon columns of liquids of considerable length—8 inches for example.

Fig. 530 represents the apparatus devised by Biot for measuring the rotatory power of liquids. On a metal groove, *g*, fixed to a support, *r*, is a



Fig. 530.

brass tube 20 centimetres long, in which is contained the liquid experimented upon. This tube, which is tinned inside, is closed at each end by glass plates fastened by screw collars. At *m* is a mirror of black glass, inclined at the polarising angle to the axis of the tubes *bd* and *a*, so that the ray reflected by the mirror *m*, in the direction *bda*, is polarised. In the centre of the graduated circle *h*, inside the tube *a*, and at right angles to the axis *bda*, is a double refracting achromatic prism, which can be turned about the axis of the apparatus by means of a button *n*. The latter is fixed to a limb *c*, on which is a vernier, to indicate the number of degrees turned through. Lastly, from the position of the mirror *m*, the plane of polarisation, *Sod*, of the reflected ray is vertical, and the zero of the graduation of the circle, *h*, is on this plane.

Before placing the tube *d* in the groove *g*, the extraordinary image furnished by the double refracting prism disappears whenever the limb *c* corresponds to the zero of the graduation, because then the double refracting prism

is so turned that its principal section coincides with the plane of polarisation (643). This is the case also when the tube  $d$  is full of water or any other *inactive* liquid, like alcohol, ether, etc., which shows that the plane of polarisation has not been turned. But if the tube be filled with a solution of cane-sugar or any other *active* liquid, the extraordinary image reappears, and to extinguish it the limb must be turned to a certain extent either to the right or to the left of zero, according as the liquid is right-handed or left-handed, showing that the polarising plane has been turned by the same angle. With solution of cane-sugar the rotation takes place to the right; and if with the same solution tubes of different lengths are taken, the rotation is found to increase proportionally to the length, in conformity with art. 655; further, with the same tube, but with solutions of various strengths, the rotation increases with the quantity of sugar dissolved, so that the quantitative analysis of a solution may be made by means of its angle of deviation.

In this experiment homogeneous light must be used; for as the various tints of the spectra have different rotatory powers, white light is decomposed in traversing an active liquid, and the extraordinary image does not disappear completely in any position of the double refracting prism—it simply changes the tint. The transition tint (659) may, however, be observed. To avoid this inconvenience, a piece of red glass is placed in the tube between the eye and the double refracting prism, which only allows red light to pass. The extraordinary image disappears in that case, whenever the principal section of the prism coincides with the plane of polarisation of the red ray.

659. **Soleil's saccharimeter.**—M. Soleil has constructed an apparatus, based upon the rotatory power of liquids, for analysing saccharine substances, to which the name *saccharimeter* is applied. Figure 531 represents the saccharimeter fixed horizontally on its foot, and fig. 532 gives a longitudinal section.

The principle of this instrument is not the amplitude of the rotation of the plane of polarisation, as in Biot's apparatus, but that of *compensation*; that is to say, a second active substance is used acting in the opposite direction to that analysed, and whose thickness can be altered until the contrary actions of the two substances completely neutralise each other. Instead of measuring the deviation of the plane of polarisation, the thickness is measured which the plate of quartz must have in order to obtain perfect compensation.

The apparatus consists of two parts—a tube containing the liquid to be analysed, a polariser, and an analyser.

The tube  $m$ , containing the liquid, is made of copper, tinned on the inside, and closed at both ends by two glass plates. It rests on a support,  $k$ , terminated at both ends by tubes,  $r$  and  $a$ , in which are the crystals used as analysers and polarisers, and which are represented in section (fig. 532).

In front of the aperture,  $S$  (fig. 532), is placed an ordinary moderator lamp. The light emitted by this lamp in the direction of the axis first meets a double refracting prism,  $r$ , which serves as polariser (641). The ordinary image alone meets the eye, the extraordinary image being projected out of the field of vision in consequence of the amplitude of the angle which the ordinary makes with the extraordinary ray. The double refracting prism is

in such a position that the plane of polarisation is vertical, and passes through the axis of the apparatus.

Emerging from the double refracting prism, the polarised ray meets a plate of quartz with double rotation; that is, this plate rotates the plane

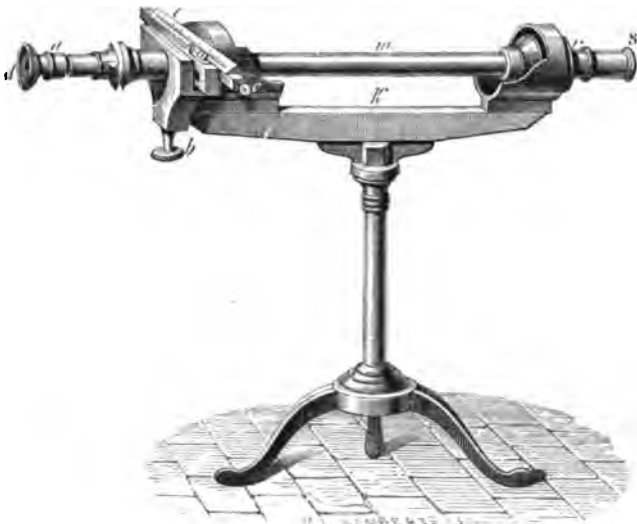

Fig. 531.

both to the right and to the left. This is effected by constructing the plate of two quartz plates of opposite rotation placed one on the other, as shown in fig. 533, so that the line of separation is vertical and in the same plane as the axis of the apparatus. These plates, cut perpendicularly to the axis, have a thickness of 3.75 millimetres, corresponding to a rotation of  $90^\circ$ , and give a rose-violet tint, called the *tint of passage or transition-tint*. As the quartz, whether right-handed or left-handed, turns always to the same extent for the same thickness, it follows that the two quartz plates, *a* and *b*, turn the plane of polarisation equally, one to the right and the other to the left. Hence, looked at through a double refracting prism, they present exactly the same tint.

Having traversed the quartz, *q*, the polarised ray passes into the liquid in the tube *m*, and then meets a single plate of quartz, *i*, of any thickness, the use of which will be seen presently. The compensator, *n*, which destroys the rotation of the column of liquid *m*, consists of two quartz plates, with the same rotation either to the right and the left, but opposite to that of the plate *i*. These two quartz plates, a section of which is represented in fig. 533, are obtained by cutting obliquely a quartz plate with parallel sides, so as to form two prisms of the same angle, *N*, *N'*; superposing, then, these two prisms, as shown in the figure, a single plate is obtained with parallel faces, which can be varied at will. This is effected by fixing each prism to a slide, so as to move it in either direction without disturbing the parallelism. This motion

is effected by means of a double rackwork and pinion motion turned by a milled head, *b* (figs. 531, 532).

When these plates move in the direction indicated by the arrows (fig. 533), it is clear that the sum of their thicknesses increases, and that it diminishes when the plates are moved in the contrary direction. A scale and a vernier follow the plates in their motion, and measure the thickness of the compensator. This scale, represented with its vernier in fig. 534, has two divisions, with a common zero, one from left to right for right-handed liquids, and another from right to left for left-handed.

When the vernier is at zero of the scale, the sum of the thicknesses of the plates *NN'* is exactly equal to that of the plate *i*, and as the rotation of the latter is opposed to that of the compensator, the effect is zero. But by moving the plates of the compensator in one or the other direction either the compensator or the quartz, *i*, preponderates, and there is a rotation from left to right.

Behind the compensator is a double refracting prism, *c* (fig. 532), serving as analyser to observe the polarised ray which has traversed the liquid and

Fig. 532.

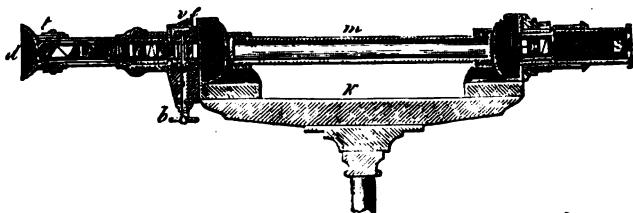

Fig. 533.

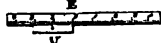

Fig. 534.



Fig. 535.

the various quartz plates. In order to understand more easily the object of the prism, *c*, we will neglect for a moment the crystals and the lenses on the left of the drawing. If at first the zero of the vernier, *o*, coincides with that of the scale, and if the liquid in the tube is inactive, the actions of the compensator, and of the plate *i*, neutralise each other; and the liquid having no action, the two halves of the plate *g*, seen through the prism *c*, give exactly the same tint as has been observed above. But if the tube filled with inactive liquid be replaced by one full of solution of sugar, the rotatory power of this solution is added to that of one of the halves (*a* or *b*) of the plate *g* (viz. that half which tends to turn the plane of polarisation in the same direction as the solution), and subtracted from that of the other. Hence the two halves of the plate *g* no longer show the same tint; the half *a*, for instance, is red, while the half *b* is blue. The prisms of the compensator are then moved by turning the milled head *b*, either to the right or to the left, until the difference of action of the compensator and of the plate *i* compensates the rotatory power of the solution, which takes place when the two halves of the plate *g*, with double rotation, revert to their original tint.

The direction of the deviation and the thickness of the compensator are measured by the relative displacement of the scale  $e$ , and of the vernier  $r$ . Ten of the divisions on the scale correspond to a difference of 1 millimetre in the thickness of the compensator; and as the vernier gives itself tenths of these divisions, it therefore measures differences of  $\frac{1}{100}$  in the thickness of the compensator.

When once the tints of the two halves of the plate are exactly the same, and therefore the same as before interposing the solution of sugar, the division on the scale corresponding to the vernier is read off, and the corresponding number gives the strength of the solution. This depends on the experimental fact that 16.471 grains of pure and well-dried sugar-candy being dissolved in water, and the solution diluted to the volume of 100 cubic centimetres, and observed in a tube of 20 centimetres in length, the deviation produced is the same as that effected by a quartz plate a millimetre thick. In making the analysis of raw sugar, a weight of 16.471 grains of sugar is taken, dissolved in water, and the solution made up to 100 cubic centimetres, with which a tube 20 centimetres in length is filled, and the number indicated by the vernier read off, when the primitive tint has been obtained. This number being 42, for example, it is concluded that the amount of crystallisable sugar in the solution is 42 per cent. of that which the solution of sugar-candy contained, and, therefore, 16.471 grains  $\times \frac{42}{100}$  or 6.918 grains. This result is only valid when the sugar is not mixed with uncrystallisable sugar or some other left-handed substance. In that case the crystallisable sugar, which is right-handed, must be, by means of hydrochloric acid, converted into uncrystallisable sugar, which is left-handed; and a new determination is made, which, together with the first, gives the quantity of crystallisable sugar.

The arrangement of crystals and lenses,  $o$ ,  $g$ ,  $f$ , and  $a$ , placed behind the prism  $c$ , forms what M. Soleil calls the *producer of sensible tints*. For the most delicate tint, that by which a very feeble difference in the coloration of the two halves of the rotation plate can be distinguished, is not the same for all eyes; for most people it is of a violet-blue tint, like flax-blossom, and it is important either to produce this tint or some other equally sensible to the eye of the observer. This is effected by placing in front of the prism  $c$ , at first a quartz plate,  $o$ , cut perpendicular to the axis, then a small Galilean telescope consisting of a double convex glass,  $g$ , and a double concave glass,  $f$ , which can be approximated or removed from each other according to the distance of distinct vision of each observer. Lastly, there is a double refracting prism,  $c$ , acting as polariser in reference to the quartz, and the prism  $a$  as analyser; and hence, when the latter is turned either right or left, the light which has traversed the prism  $c$ , and the plate  $o$ , changes its tint, and finally gives that which is the most delicate for the experimenter.

**660. Analysis of diabetic urine.**—In the disease *diabetes*, the urine contains a large quantity of fermentescible sugar, called diabetic sugar, which in the natural condition of the urine turns the plane of polarisation to the right. To estimate the quantity of this sugar, the urine is first clarified by heating it with acetate of lead and filtering; the tube is filled with the clear liquid thus obtained; and the milled head,  $b$ , turned, until by means of the double rotating plate the same tint is obtained as before the interposition

of the urine. Experiment has shown that 100 parts of the saccharimetric scale represent the displacement which the quartz compensators must have when there are 225·6 grains of sugar in a litre ; hence each division of the scale represents 2·256 of sugar. Accordingly, to obtain the quantity of sugar in a given urine, the number indicated by the vernier, at the moment at which the primitive tint reappears, must be multiplied by 2·256.

661. **Polarisation of heat.**—The rays of heat, like those of light, may become polarised by reflection and by refraction. The experiments on this subject are difficult of execution ; they were first made by Malus and Berard, in 1810 ; after the death of Malus they were continued by the latter philosopher.

In his experiments, the calorific rays reflected from one mirror were received upon a second, just as in Norremberg's apparatus ; from the second they fell upon a small metallic reflector, which concentrated them upon the bulb of a differential thermometer. Berard observed that heat was not reflected when the plane of reflection of the second mirror was at right angles to that of the first. As this phenomenon is the same as that presented by light under the same circumstances, Berard concluded that heat became polarised in being reflected.

The double refraction of heat may be shown by concentrating the sun's rays by means of a heliostat on a prism of Iceland spar, and investigating the resultant pencil by means of a thermopile, which must have a sharp narrow edge. In this case also there is an ordinary and an extraordinary ray, which follow the same laws as those of light. In the optic axis of the calcspar, heat is not doubly refractive. A Nicol's prism can be used for the polarisation of heat as well as for that of light ; a polarised ray does not traverse the second Nicol if the plane of its principal section is perpendicular to the vibrations of the ray. The phenomena of the polarisation of heat may also be studied by means of plates of tourmaline and of mica. The angle of polarisation is virtually the same for heat as for light. In all these experiments the prisms must be very near each other.

The diffraction, and therefore the interference, of rays of heat has recently been established by the experiments of Knoblauch and others. And Forbes, who has repeated Fresnel's experiment with a rhombohedron of rock salt, has found that heat by two total internal reflections is circularly polarised, just as is the case with light.

## BOOK VIII.

## ON MAGNETISM.

## CHAPTER I.

## PROPERTIES OF MAGNETS.

662. **Natural and artificial magnets.**—*Magnets* are substances which have the property of attracting iron, and the term *magnetism* is applied to the cause of this attraction, and to the resulting phenomena.

This property was known to the ancients ; it exists in the highest degree in an ore of iron which is known in chemistry as the magnetic oxide of iron. Its composition is represented by the formula  $Fe_3O_4$ .

This magnetic oxide of iron, or *lodestone*, as it is called, was first found at Magnesia, in Asia Minor, the name magnet being derived from this circumstance. The name lodestone, which is applied to this natural magnet was given on account of its being used when suspended as a guiding or leading stone, from the Saxon *ladan*, to lead ; so also the word lodestar. Lodestone is very abundant in nature : it is met with in the older geological formations, especially in Sweden and Norway, where it is worked as an iron ore, and furnishes the best quality of iron.

When a bar or needle of steel is rubbed with a magnet, it acquires magnetic properties. Such bars are called *artificial magnets* ; they are more powerful than natural magnets, and as they are also more convenient, they will be exclusively referred to in describing the phenomena of magnetism ; the best modes of preparing them will be explained in a subsequent article.

663. **Poles and neutral line.**—When a small particle of soft iron is suspended by a thread, and a magnet is approached to it, the iron is attracted towards the magnet, and some force is required for its removal. The force of the attraction varies in different parts of the magnet ; it is strongest at the two ends, and is totally wanting in the middle.

This variation may also be seen very clearly when a magnetic bar is placed in iron filings ; these become arranged round the ends of the bar in feathery tufts, which decrease towards the middle of the bar, where there are none. That part of the surface of the bar where there is no visible magnetic force is called the *neutral line* ; and the points near the ends of the bar where the attraction is greatest are called the *poles*.



Every magnet, whether natural or artificial, has two poles and a neutral line : sometimes, however, in magnetising bars and needles, poles are produced lying between the extreme points. Such magnets are abnormal, and these points are called *intermediate* or *consequent poles*. The shortest line joining the two poles is termed the *axis* of the magnet ; in a horseshoe magnet the axis is in the direction of the keeper. The plane at right angles to the axis of a bar magnet and passing through the neutral line is sometimes called the *equator* of the magnet.

We shall presently see that a freely suspended magnet always sets with one pole pointing towards the north, and the other towards the south. The



Fig. 536.

end pointing towards the north is called in this country the *north pole*, and the other end is the *south pole*. The end of the magnetic needle pointing to the north is also sometimes called the *marked end* of the needle. Sometimes also the end pointing to the north is called the *red pole*, and that to the south, the *blue pole* ; the corresponding terms red and blue magnetisms are also used.

664. **Mutual action of two poles.**—The two poles of a magnet appear

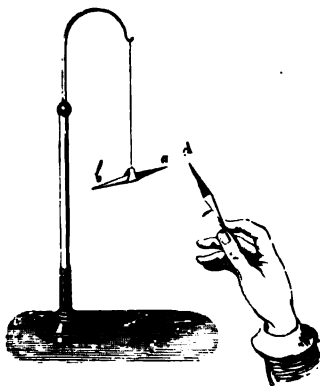

Fig. 537.

identical when they are brought in contact with iron filings, but this identity is only apparent, for when a small magnetic needle, *ab* (fig. 537), is suspended by a fine thread, and the north pole, *A*, of another needle is brought near its north pole, *a*, a repulsion takes place. If, on the contrary, *A* is brought near the south pole, *b*, of the movable needle, the latter is strongly attracted. Hence these two poles, *a* and *b*, are not identical, for one is repelled and the other attracted by the same pole of the magnet, *A*. It may be shown in the same manner that the two poles of the latter are also different, by successively presenting them to the same pole, *a*, of the movable needle. In one

case there is repulsion, in the other attraction. Hence the following law may be enunciated :

*Poles of the same name repel, and poles of contrary name attract one another.*

The opposite actions of the north and south poles may be shown by the following experiment :—A piece of iron, a key for example, is supported by a magnetised bar. A second magnetised bar of the same dimensions is then

moved along the first, so that their poles are contrary (fig. 538). The key remains suspended so long as the two poles are at some distance, but when they are sufficiently near, the key drops, just as if the bar which supported it had lost its magnetism. This, however, is not the case, for the key would

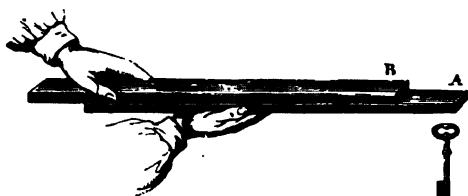

Fig. 538.

be again supported if the first magnet were presented to it after the removal of the second bar.

The attraction which a magnet exerts upon iron is reciprocal, which is indeed a general principle of all attractions. It is easily verified by presenting a mass of iron to a movable magnet, when the latter is attracted.

**665. Hypothesis of two magnetic fluids.**—In order to explain the phenomena of magnetism, the existence of two hypothetical *magnetic fluids* has been assumed, each of which acts repulsively on itself, but attracts the other fluid. The fluid predominating at the north pole of the magnet is called the *north fluid or red magnetism*, and that at the south pole, the *south fluid or blue magnetism*. The term 'fluid' is apt to puzzle beginners, from its ambiguity. Ordinarily the idea of a liquid is associated with the term a fluid; hence the use of this term to explain the phenomena of magnetism and electricity has produced a widely prevailing impression of the material nature of these two forces. The word fluid, it must be remembered, embraces gases as well as liquids, and here it must be pictured to the mind as representing an invisible, elastic, gaseous atmosphere or shell surrounding the particles of all magnetic substances.

It is assumed that, before magnetisation, these fluids are combined round each molecule, and mutually neutralise each other; they can be separated by the influence of a force greater than that of their mutual attraction, and can arrange themselves round the molecules to which they are attached, but cannot be removed from them.

The hypothesis of the two fluids is convenient in explaining magnetic phenomena, and will be adhered to in what follows. But it must not be regarded as anything more than an hypothesis, and it will afterwards be shown (826) that magnetic phenomena appear to result from electrical currents, circulating in magnetic bodies; a mode of view which connects the theory of magnetism with that of electricity.

**666. Precise definition of poles.**—By aid of the preceding hypothesis we are enabled to obtain a clearer idea of the distribution of the magnetism in a magnetised bar, and to account for the circumstance that there is no free magnetism in the middle of the bar, and that it is strongest at the poles. If AB (fig. 539) represent a magnet, then the alternate black and white

spaces may be taken to represent the position of the magnetic fluids in a series of particles after magnetisation ; in accordance with what has been said, the white spaces, representing the south fluid, all point in one direction, and the north fluid in the opposite direction. The last half of the terminal molecule at one end would have north polarity, and at the other south polarity. Let  $N$  represent the north pole of a magnetic needle placed near the magnet  $AB$  ; then the south fluid,  $s$ , in the terminal molecule would tend

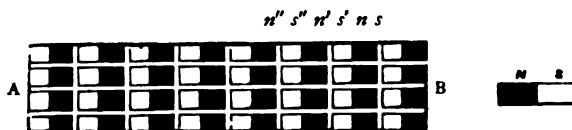

Fig. 539.

to attract  $N$ , and the north fluid  $n$  would tend to repel it ; but as the molecule of south fluid  $s$  is nearer  $N$  than the molecule of the north fluid  $n$ , the attraction between  $s$  and  $N$  would be greater than the repulsion between  $n$  and  $N$ . Similarly the attraction between  $s'$  and  $N$  would be greater than the repulsion between  $n'$  and  $N$ , and so on with the following  $s''$  and  $n''$ , etc. And all these forces would give a resultant tending to attract  $N$ , whose point of application would have a certain fixed position, which would be the south pole of  $AB$ . In like manner it might be shown that the resultant of the forces acting at the other end of the bar would form a north pole, and would hence repel the north pole of the needle, but would attract its south pole.

That such a series of polarised particles really acts like an ordinary magnet may be shown by partly filling a glass tube with steel filings, and passing the pole of a strong magnet several times along the outside in one constant direction, taking care not to shake the tube. The individual filings will thus be magnetised, and the whole column of them presented to a magnetic needle will attract and repel its poles just like an ordinary bar magnet, exhibiting a north pole at one end, a south pole at the other, and no polarity in the middle ; but on shaking the tube, or turning out the filings, and putting them in again so as to destroy the regularity, every trace of polarity will disappear. It appears hence that the polarity at each end of a magnet is caused by the fact that the resultant action on a magnetic body is strongest near the ends, and does not arise from any accumulation of magnetic fluids at the ends.

The same point may be illustrated by the following experiment, which is due to Grove. In a glass tube with flat glass ends is placed water in which is diffused magnetic oxide of iron. Round the outside of the tube is coiled some insulated wire. On looking at a light through the tube the liquid appears dark and muddy, but on passing a current of electricity through the wire it becomes clearer (829). This is due to the fact that by the magnetising action of the current, the particles, becoming magnetised, set with their longest dimension parallel to the axis of the tube, in which position they obstruct the passage of light to a less extent.

667. **Experiments with broken magnets.**—That the two magnetic fluids are present in all parts of the bar, and are not simply accumulated at the ends, is also evident from the following experiment. A steel knitting-needle is magnetised by friction with one of the poles of a magnet, and then, the existence of the two poles and of the neutral line having been ascertained by means of iron filings, it is broken in the middle. But now, on presenting successively the two halves to a magnet, each will be found to possess two opposite poles and a neutral line, and in fact is a perfect magnet. If these new magnets are broken in turn in two halves, each will be a complete magnet with its two poles and neutral line, and so on, as far as the division can be continued. It is, therefore, concluded by analogy that the smallest parts of a magnet, the ultimate molecules, contain the two magnetisms.

668. **Magnetic induction.**—When a magnetic substance is placed in contact with a magnet, the two fluids of the former become separated; and so long as the contact remains, it is a complete magnet, having its two poles and its neutral line. For instance, if a small cylinder of soft iron *ab* (fig. 540), be placed in contact with one of the poles of a magnet, the cylinder can

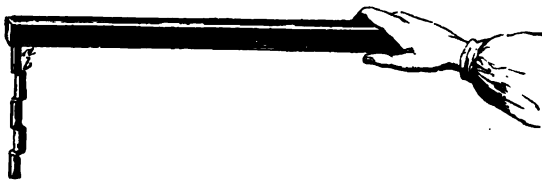

Fig. 540.

in turn support a second cylinder; this in turn a third and so on, to as many as seven or eight, according to the power of the magnet. Each of these little cylinders is a magnet; if it be the north pole of the magnet to which the cylinders are attached, the part *a* will have south, and *b* north magnetism; *b* will in like manner develop in the nearest end of the next cylinder south magnetism, and so on. But these cylinders are only magnets so long as the influence of a magnetised bar continues. For, if the first cylinder be removed from the magnet, the other cylinders immediately drop, and retain no trace of magnetism. The separation of the two magnetisms is only momentary, which proves that the magnet yields nothing to the iron. Hence we may have *temporary* magnets as well as *permanent* magnets: the former of iron and nickel, the latter of steel and cobalt (663).

This action, in virtue of which a magnet can develop magnetism in iron, is called *magnetic induction* or *influence*, and it can take place without actual contact between the magnet and the iron, as is seen in the following experiment. A bar of soft iron is held with one end near a magnetic needle. If now the north pole of a magnet be approached to the iron without touching it, the needle will be attracted or repelled, according as its south or north pole is near the bar. For the north pole of the magnet will develop south magnetism in the end of the bar nearest it, and therefore north magnetism at the other end, which would thus attract the south, but repel the north end of the needle. Obviously, if the other end of the magnet were

brought near the iron, the opposite effects would be produced on the needle ; or if the opposite pole of a second magnet of equal strength simultaneously be brought near the iron, the needle would be unaffected, as one magnet would undo the work of the other.

Among other things, magnetic induction explains the formation of the tufts of iron filings which become attached to the poles of magnets. The parts in contact with the magnet are converted into magnets ; these act inductively on the adjacent parts, these again on the following ones, and so on, producing a filamentary arrangement of the filings. The bush-like appearance of these filaments is due to the repulsive action which the free poles exert upon each other. Any piece of soft iron while being attracted by a magnet is for the time being converted into a magnet ; hence is explained the paradoxical statement that magnets only attract magnets.

669. **Coercive force.**—We have seen from the above experiments that soft iron becomes instantaneously magnetised under the influence of a magnet, but that this magnetism is not permanent, and ceases when the magnet is removed. Steel likewise becomes magnetised by contact with a magnet, but the operation is effected with difficulty, and the more so as the steel is more highly tempered. Placed in contact with a magnet, a steel bar acquires magnetic properties very slowly, and to make the magnetism complete, the steel must be rubbed with one of the poles. But this magnetism, once evoked in steel, is permanent, and does not disappear when the inducing force is removed.

These different effects in soft iron and steel are ascribed to a *coercive force*, which, in a magnetic substance, offers a resistance to the separation of the two magnetisms, but which also prevents their recombination when once separated. In steel this coercive force is very great, in soft iron it is very small or almost absent. By oxidation, pressure, or torsion, a certain amount of coercive force may be imparted to soft iron : and by heat, hammering, etc., the coercive force may be lessened, as will be afterwards seen.

670. **Difference between magnets and magnetic substances.**—*Magnetic substances* are substances which, like iron, steel, nickel, are attracted by the magnet. They contain the two fluids, but in a state of neutralisation. Compounds containing iron are usually magnetic, and the more so in proportion as they contain a larger quantity of iron. Some, however, like iron pyrites, are not attracted by the magnet.

A magnetic substance is readily distinguished from a magnet. The former has no poles ; if successively presented to the two ends of a magnetic needle, *ab* (fig. 537), it will attract both ends equally, while with one and the same end a magnet would attract the one end of the needle, but repel the other. Magnetic substances also have no action on each other, while magnets attract or repel each other, according as unlike or like poles are presented. Attraction is no proof that a body is a magnet ; repulsion is.

Iron is not the only substance which possesses magnetic properties ; nickel has considerable magnetic power, but far less than that of iron ; cobalt is less magnetic than nickel ; while to even a slighter extent chromium and manganese are magnetic. Further, we shall see that powerful magnets exert a peculiar influence on all substances.

CHAPTER II.

TERRESTRIAL MAGNETISM. COMPASSES.

671. **Directive action of the earth on magnets.**—When a magnetised needle is suspended by a thread, as represented in fig. 537, or when placed on a pivot on which it can move freely (fig. 541), it ultimately sets in a position which is more or less north and south. If removed from this position it always returns to it after a certain number of oscillations.

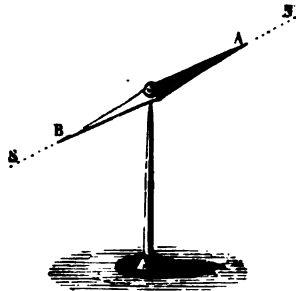

Fig. 541.

Analogous observations have been made in different parts of the globe, from which the earth has been compared to an immense magnet, whose poles are very near the terrestrial poles, and whose neutral line virtually coincides with the equator.

The polarity in the northern hemisphere is called the *northern* or *boreal* polarity and that in the southern hemisphere the *southern* or *austral* polarity. In French works the end of the needle pointing north is called the *austral* or *southern* pole, and that pointing to the south, the *boreal* or *northern* pole ; a designation based on this hypothesis of a terrestrial magnet, and on the law that unlike magnetisms attract each other. In practice it will be found more convenient to use the English names, and call that end of the magnet which points to the north the *north pole*, and that which points to the south the *south pole* ; the north pole of a magnet is a *north seeking* pole, and a south pole a *south seeking* pole. To avoid ambiguity that end of the needle pointing north is in England sometimes spoken of as the *marked end* of the needle (663).

672. **Terrestrial magnetic couple.**—From what has been stated, it is clear that the magnetic action of the earth on a magnetised needle may be compared to a *couple*, that is, to a system of two equal forces, parallel, but acting in contrary directions.

For let  $ab$  (fig. 542) be a movable magnetic needle making an angle with the magnetic meridian  $M'M$  (673). The earth's north pole acts attractively

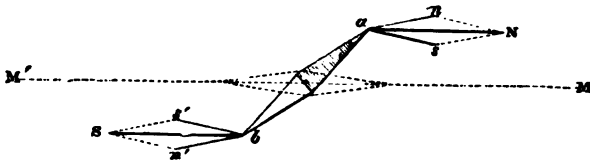

Fig. 542.

on the marked pole,  $a$ , and repulsively on the other pole,  $b$ , and two contrary forces are produced,  $an$  and  $bn'$ , which are equal and parallel : for the terrestrial pole is so distant, and the needle so small, as to justify the assumption that the two directions,  $an$  and  $bn'$ , are parallel, and that the two poles

are equidistant from the earth's north pole. But the earth's south pole acts similarly on the poles of the needle, and produces two other forces,  $as$  and  $bs'$ , which are also equal and parallel, but the two forces  $an$  and  $as$  may be reduced to a single resultant  $aN$  (33) and the forces  $bn'$  and  $bs'$  to a resultant  $bS$ ; the two forces  $aN$  and  $bS$  are equal, parallel, and act in opposite directions, and they constitute the *terrestrial magnetic couple*; it is this couple which makes the needle set ultimately in the magnetic meridian, a position in which the two forces  $N$  and  $S$  are in equilibrium.

The force which determines the direction of the needle thus is neither attractive or repulsive, but simply directive. If a small magnet be placed on a cork floating in water, it will at first oscillate, and then gradually set in a line which is virtually north and south. But if the surface of the water be quite smooth, the needle will not move either towards the north or towards the south.

If, however, a magnet be approached to a floating needle, attraction or repulsion ensues, according as one or the other of the poles is presented. The reason of the different actions exerted by the earth and by a magnet on a floating needle is as follows: When the north pole, for instance, of the magnet is presented to the south pole of the needle, the latter is attracted; it is, however, repelled by the south pole of the magnet. Now the force of magnetic attraction or repulsion decreases with the distance, and as the distance between the south pole of the needle and the north pole of the magnet is less than the distance between the south pole of the needle and the south pole of the magnet, the attraction predominates over the repulsion, and the needle moves towards the magnet. But the earth's magnetic north pole is so distant from the floating needle that its length may be considered infinitely small in comparison, and one pole of the needle is just as strongly repelled as the other is attracted.

673. **Magnetic elements. Declination.**—In order to obtain a full knowledge of the earth's magnetism at any place three essentials are requisite; these are: i. Declination; ii. Inclination; iii. Intensity. These three are termed the *magnetic elements* of the place. We shall explain them in the order in which they stand.

The *geographical meridian* of a place is the imaginary plane passing through this place and through the two terrestrial poles, and the *meridian* is the outline of this plane upon the surface of the globe. Similarly the *magnetic meridian* of a place is the vertical plane passing at this place through the two poles of a movable magnetic needle in equilibrium about its vertical axis.

In general the magnetic meridian does not coincide with the geographical meridian, and the angle which the magnetic makes with the geographical meridian, or, what is the same thing, the angle which the direction of the needle makes with the meridian, is called the *declination* or *variation of the magnetic needle*. The declination is said to be *east* or *west*, according as the north pole of the needle is to the east or west of the geographical meridian.

674. **Variations in declination.**—The declination of the magnetic needle, which varies in different places, is at present west in Europe and in Africa, but east in Asia and in the greater part of North and South America. It shows further considerable variations even in the same place; these

variations are of two kinds ; some are regular, and are either secular, annual, or diurnal ; others, which are irregular, are called *perturbations* or *magnetic storms*.

*Secular variations.*—In the same place, the declination varies in the course of time, and the needle appears to make oscillations to the east and west of the meridian, the duration of which extends over centuries. The declination has been known at Paris since 1580, and the following table represents the variations which it has undergone :—

Year	Declination	Year	Declination
1580 . . . . .	11° 30' E.	1825 . . . . .	22° 22' W.
1663 . . . . .	0	1830 . . . . .	22° 12' W.
1700 . . . . .	8° 10' W.	1835 . . . . .	22° 4' W.
1780 . . . . .	19° 55' W.	1850 . . . . .	20° 30' W.
1785 . . . . .	22° W.	1855 . . . . .	19° 57' W.
1805 . . . . .	22° 5' W.	1860 . . . . .	19° 32' W.
1814 . . . . .	22° 34' W.	1865 . . . . .	18° 44' W.
		1875 . . . . .	17° 21' W.

This table shows that since 1580 the declination has varied at Paris as much as 34°, and that the greatest westerly declination was attained in 1814, since which time the needle has gradually tended towards the east.

At London, the needle showed in 1580 an easterly declination of 11° 36' ; in 1663 it was at zero ; from that time it gradually tended towards the west, and reached its maximum declination of 24° 41' in 1818 ; since then it has steadily diminished ; it was 22° 30' in 1850, 19° 32' in 1873, 19° 24' in 1874, 19° 16' in 1875, 19° 10' in 1876, and is now (1877) 19° 3' W.

At Yarmouth and Dover the variation is about 40' less than at London ; at Hull and Southampton about 20' greater ; at Newcastle and Swansea about 1° 45', and at Liverpool 2° 0', at Edinburgh 3° 0', and at Glasgow and Dublin about 3° 50', greater than at London.

The following are the observations of the magnetic elements at Kew for the last twelve years :—

Year	Declination	Inclination	Horizontal Intensity
1865 . . . . .	20° 59'	68° 7'	3·829
1866 . . . . .	20° 51'	68° 6'	3·837
1867 . . . . .	20° 40'	68° 3'	3·844
1868 . . . . .	20° 33'	68° 2'	3·848
1869 . . . . .	20° 25'	68° 1'	3·852
1870 . . . . .	20° 19'	67° 58'	3·857
1871 . . . . .	20° 10'	67° 57'	3·863
1872 . . . . .	20° 0'	67° 54'	3·869
1873 . . . . .	19° 57'	67° 52'	3·877
1874 . . . . .	19° 52'	67° 50'	3·881
1875 . . . . .	19° 41'	67° 48'	3·885
1876 . . . . .	19° 31'	67° 46'	3·885

In certain parts of the earth the magnet coincides with the geographical meridian. These points are connected by an irregularly curved imaginary line, called a *line of no variation*, or *agonic line*. Such a line cuts the east



of South America, and, passing east of the West Indies, enters North America near Philadelphia, and traverses Hudson's Bay; thence it passes through the North Pole, entering the Old World east of the White Sea, traverses the Caspian, cuts the east of Arabia, turns then towards Australia, and passes through the South Pole, to join itself again.

*Isogonic lines* are lines connecting those places on the earth's surface in which the declination is the same. The first of the kind was constructed in 1700 by Halley; as the elements of the earth's magnetism are continually changing, the course of such a line can only be determined for a certain time. One of the newest set of isogonic lines was constructed by Captain Evans for the year 1857, and is given in the British Association Report for 1861.

Maps on which such isogonic lines are depicted are called *declination maps*; and a comparison of these in various years is well fitted to show the variation which this magnetic element undergoes. Plate III. represents a map in Mercator's projection giving these lines for the year 1860. It extends from 80° N. to 60° S. latitude, and from the nature of the case cannot include both poles, for which a map in polar projection is needed. The figures attached to the red lines represent the observed angles of declination; the dotted red lines are the result of calculation.

675. **Annual variations.**—Cassini first discovered, in 1780 that the declination is subject to small annual variations. At Paris and London it is greatest about the vernal equinox, diminishes from that time to the summer solstice, and increases again during the nine following months. It does not exceed from 15' to 18', and it varies somewhat at different epochs.

The *diurnal variations* were first discovered by Graham in 1722; they can only be observed by means of long needles or delicate indicators such as the reflection of a ray of light (508) and very sensitive instruments (684). In this country the north pole moves every day from east to west from sunrise until one or two o'clock; it then tends towards the east, and at about ten o'clock regains its original position. During the night the needle is almost stationary. Thus the westerly declination is greatest during the warmest part of the day.

At Paris the mean amplitude of the diurnal variation from April to September is from 13' to 15', and for the other months from 8' to 10'. On some days it amounts to 25', and on others does not exceed 5'. The greatest variation is not always at the same time. The amplitude of the daily variations decreases from the poles towards the equator, where it is very feeble. Thus in the island of Rewak it never exceeds 3' to 4'.

676. **Accidental variations and perturbations.**—The declination is accidentally disturbed in its daily variations by many causes, such as earthquakes, the *aurora borealis*, and volcanic eruptions. The effect of the aurora is felt at great distances. Auroras which are only visible in the north of Europe act on the needle even in these latitudes, where accidental variations of 1° or 2° have been observed. In polar regions the needle frequently oscillates several degrees; its irregularity on the day before the aurora borealis is a presage of the occurrence of this phenomenon.

Another remarkable phenomenon is the simultaneous occurrence of magnetic perturbations in very distant countries. Thus Sabine mentions a mag-

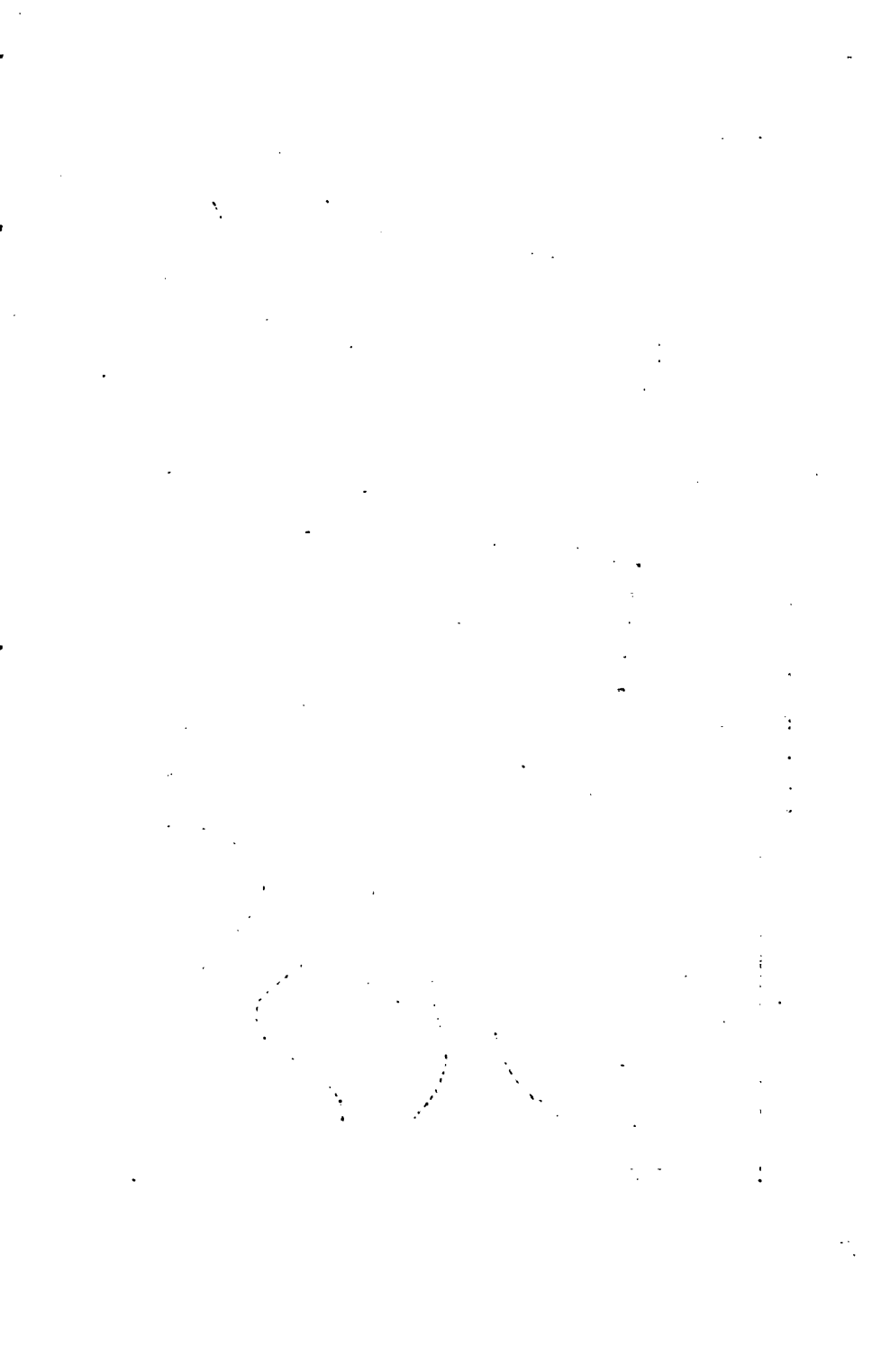



netic disturbance which was felt simultaneously at Toronto, the Cape, Prague, and Van Diemen's land. Such simultaneous perturbations have received the name of *magnetic storms*.

677. **Declination compass.**—The *declination compass* is an instrument by which the magnetic declination of any place may be measured when its astronomical meridian is known. It consists of a brass box, AB (fig. 543), in the bottom of which is a graduated circle, M. In the centre is a pivot, on which oscillates a very light lozenge-shaped magnetic needle, *ab*. To the box are attached two uprights supporting a horizontal axis, X, on which is fixed an astronomical telescope, L, movable in a vertical plane. The box



Fig. 543.

rests on a foot, P, about which it can turn in a horizontal plane, taking with it the telescope. A fixed circle, QR, which is called the *azimuthal circle*, serves to measure the number of degrees through which the telescope has been turned, by means of a vernier, V, fixed to the box. The inclination of the telescope, in reference to the horizon, may be measured by another vernier, K, which moves with the axis of the telescope, and is read off on a fixed graduated arc, *x*.

The first thing in determining the declination is to adjust the compass horizontally by means of the screws, SS, and the level, *n*. The astronomical meridian is then found either by an observation of the sun at noon exactly, or by any of the ready methods known to astronomers. The box, AB, is then turned until the telescope is in the plane of the astronomical meridian.

The angle made by the magnetic needle with the diameter,  $N$ , which corresponds with the zero of the scale, and is exactly in the plane of the telescope, is then read off on the graduated limb, and this is east or west, according as the pole,  $a$ , of the needle stops at the east or west of the diameter,  $N$ .

678. **Correction of errors.**—These indications of the compass are only correct when the magnetic axis of the needle, that is, the right line passing through the two poles, coincides with its axis of figure, or the line connecting its two ends. This is not usually the case, and a correction must therefore be made, which is done by the *method of reversion*. For this purpose the needle is not fixed in the cap, but merely rests on it, so that it can be removed and its positions reversed; thus what was before the lower is now the upper face. The mean between the observations made in the two cases gives the true declination.

For, let  $NS$  be the astronomical meridian,  $ab$  the axis of figure of the needle, and  $mn$  its magnetic axis (fig. 544). The true declination is not the

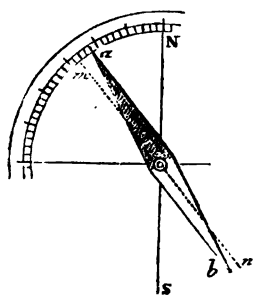

Fig. 544.

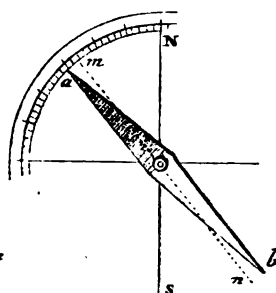

Fig. 545.

arc  $Na$  but the arc  $Nm$ , which is greater. If now the needle be turned, the line  $mn$  makes the same angle with the meridian  $NS$ ; but the north end of the needle which was on the right of  $mn$  is now on the left (fig. 545), so that the declination which was previously too small by a certain amount, is now too large by the same amount. Hence the true declination is given by the mean of these two observations.

679. **Mariner's compass.**—The magnetic action of the earth has received its most important application in the *mariner's compass*. This is a declination compass used in guiding the course of a ship. Figure 546 represents a view of the whole, and figure 547 a vertical section. It consists of a cylindrical case, which, to keep the compass in a horizontal position in spite of the rolling of the vessel, is supported on *gimbals*. These are two concentric rings, one of which attached to the case itself moves about the axis  $cd$  which plays in the outer ring  $AB$ , and this moves in the supports  $PQ$ , about the axis  $mn$  at right angles to the first.

In the bottom of the box is a pivot, on which is placed by means of an agate cap, a magnetic bar  $ab$ , which is the needle of the compass. On this is fixed a disc of mica, a little larger than the length of the needle, on which is traced a star or *rose* with thirty-two branches, making the eight points or

*rhumbs* of the wind, the demi-rhumbs and the quarters. The branch ending in a small star and called N, corresponds to the bar *ab*, which is underneath the disc.



Fig. 546.

The compass is placed near the stern of the vessel in the *binnacle*. Knowing the direction of the compass in which the ship is to be steered, the pilot has the rudder turned till the direction coincides with the sight vane passing through a line *d* marked on the inside of the box, and parallel with the keel of the vessel.

Neither the inventor of the compass, nor the exact time of its invention, is known. Guyot de Provins, a French poet of the twelfth century, first

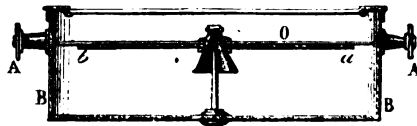

Fig. 547.

mentions the use of the magnet in navigation, though it is probable that the Chinese long before this had used it. The ancient navigators, who were unacquainted with the compass, had only the sun or pole star as a guide, and were accordingly compelled to keep constantly in sight of land for fear of steering in a wrong direction when the sky was clouded.

**680. Inclination. Magnetic equator.**—It might be supposed from the northerly direction which the magnetic needle takes, that the force acting upon it is situated in a point of the horizon; this is not the case, for if the needle be so arranged that it can move freely in a vertical plane about a horizontal axis, it will be seen that, although the centre of gravity of the needle coincides with the centre of suspension, the north pole in our hemisphere dips downwards. In the other hemisphere the south pole is inclined downwards.

The angle which the magnetic needle makes with the horizon, when the vertical plane, in which it moves, coincides with the magnetic meridian, is called the *inclination* or *dip* of the needle. In any other plane than the magnetic meridian, the inclination *increases*, and is  $90^\circ$  in a plane at right angles to the magnetic meridian. For the magnetic inclination is the resultant of two forces, one acting in a horizontal and the other in a vertical plane. When the needle is moved so that it is at right angles to the magnetic meridian, the horizontal component can only act in the direction of the axis of suspension, and, therefore, cannot affect the needle, which is then solely influenced by the vertical component, and stands vertically. The following considerations will make this clearer:—

Let NS (fig. 548) represent a magnetic needle capable of moving in a vertical plane. Let NT represent in direction and intensity the entire

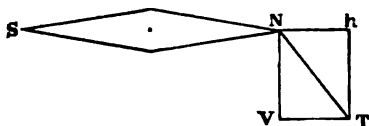

Fig. 548.

force of the earth's magnetism acting on the pole N. Then NT can be resolved into the forces Nh and NV; TNh being the angle of inclination or dip.

NT is termed the *total force*, and its components are Nh, or the *horizontal force*, and NV, or the *vertical force*.

Now, it is clear that the greater the angle of dip, TNh, the less becomes Nh, or the horizontal force, and the greater NV, or the vertical force. Hence, in high latitudes the directive force of a compass, which depends on the horizontal force, is less than in low latitudes. At the magnetic poles the horizontal force will be *nil*, and the vertical force a maximum; here, therefore, the needle will be vertical. At the magnetic equator the reverse is the case, and the needle will be horizontal. Hence, the oscillations of a *compass* needle, by which, as will presently be explained, the strength of the earth's magnetism is measured, become fewer and fewer in a given time as the magnetic poles are approached, although there is really an increase in the total force of the earth.

Again, the reason why a dipping-needle stands vertical when placed E. and W. is clearly because in those positions the horizontal force now acting at right angles to the plane of motion of the needle is ineffectual to move it, and therefore merely produces a pressure on the pivot which supports the needle. But the vertical component of the total force remains unaffected by the new position of the needle. Acting, therefore, entirely alone when the dipping-needle is exactly E. and W., this vertical component drags the needle into a line with itself, that is  $90^\circ$  from the horizontal plane.

The value of the dip, like that of the declination, differs in different localities. It is greatest in the polar regions, and decreases with the latitude to the equator, where it is approximately zero. In London at the present time, 1877, the dip is  $67^\circ 37'$ , reckoning from the horizontal line. In

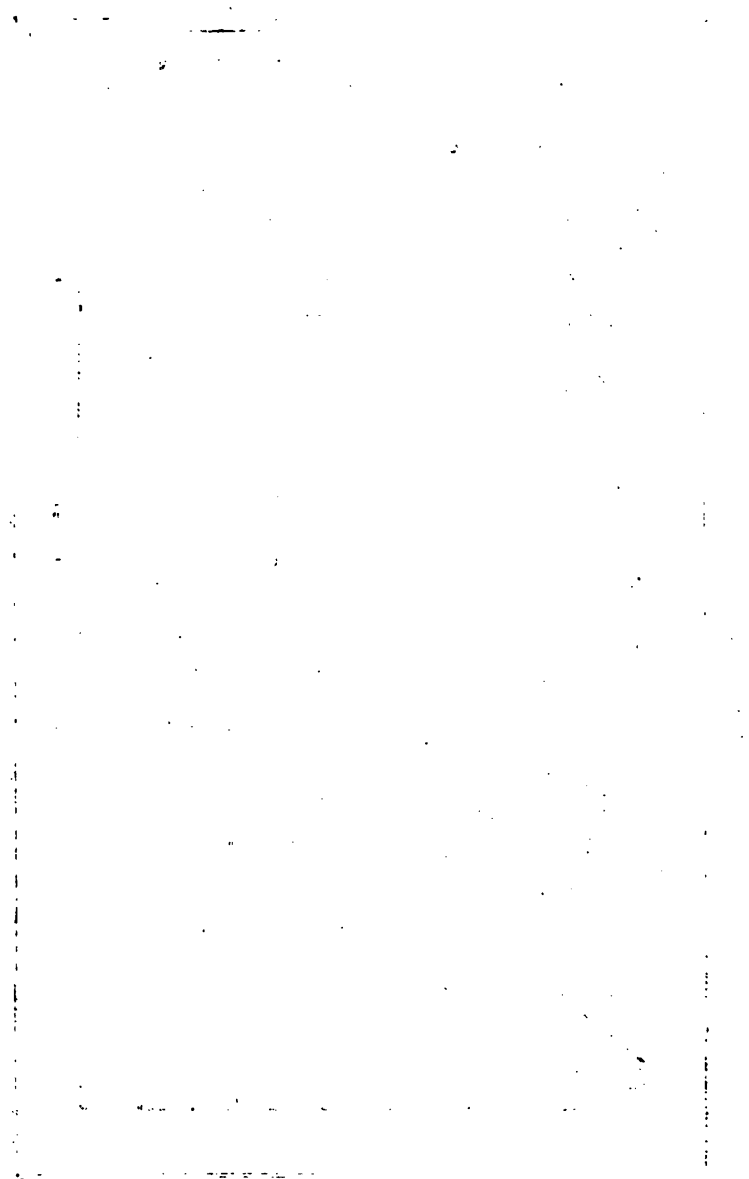



ISOTHERM LINES FOR THE YEAR 1860.

FIG. IV.

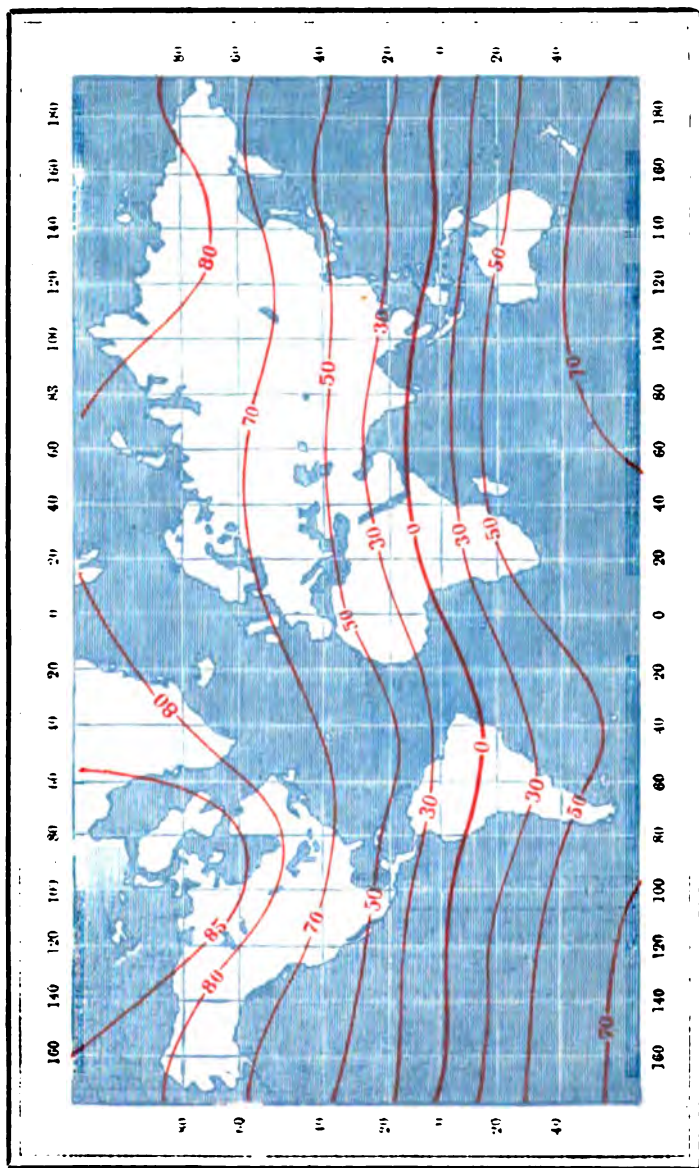

the southern hemisphere the inclination is again seen, but in a contrary direction, that is, the south pole of the needle dips below the horizontal line.

The *magnetic poles* are those places in which the dipping-needle stands vertical, that is, where the inclination is  $90^\circ$ . In 1830 the first of these, the terrestrial north pole, was found by Sir James Ross in  $96^\circ 43'$  west longitude and  $70^\circ$  north latitude. The same observer found in the South Sea, in  $76^\circ$  south latitude and  $168^\circ$  east longitude, that the inclination was  $88^\circ 37'$ . From this and other observations, it has been calculated that the position of the magnetic south pole was at that time in about  $154^\circ$  east longitude and  $75\frac{1}{2}^\circ$  south latitude. The line of no declination passes through these poles, and the lines of equal declination converge towards them.

The *magnetic equator* or *aclinic line* is the line which joins all those places on the earth where there is no dip, that is, all those in which the dipping-needle is quite horizontal. It is a somewhat sinuous line, not differing much from a great circle inclined to the equator at an angle of  $12^\circ$ , and cutting it on two points almost exactly opposite each other, one in the Atlantic, and one in the Pacific. These points appear to be gradually moving their position, and travelling from east to west.

Lines connecting places in which the dipping-needle makes equal angles are called *isoclinic lines*.

Plate IV. is an inclination map for the year 1860, the construction of which is quite analogous to that of the map of declination.

The inclination is subject to secular variations, like the declination, as is readily seen from a comparison of maps of inclination for different epochs. At Paris, in 1671, the inclination was  $75^\circ$ ; since then it has been continually decreasing, in 1835 it was  $67^\circ 14'$ ; in 1849  $67^\circ$ ; in 1859  $66^\circ 14'$ ; and in 1874  $65^\circ 23'$ .

The following table gives the alterations in the inclination at London, from which it will be seen that since 1723, in which it was at its maximum, it has continually diminished by little more than two minutes in each year.

Year	Inclination	Year	Inclination
1576	$71^\circ 50'$	1828	$69^\circ 47'$
1600	$72^\circ$	1838	$69^\circ 17'$
1676	$73^\circ 30'$	1854	$68^\circ 31'$
1723	$74^\circ 42'$	1859	$68^\circ 21'$
1773	$72^\circ 19'$	1874	$67^\circ 43'$
1780	$72^\circ 8'$	1875	$67^\circ 42'$
1790	$71^\circ 33'$	1876	$67^\circ 39'$
1800	$70^\circ 35'$	1877	$67^\circ 37'$
1821	$70^\circ 31'$		

**681. Inclination compass.**—An inclination compass is an instrument for measuring the magnetic inclination or dip. It consists of a graduated horizontal brass circle, *m* (fig. 549), supported on three legs, provided with levelling screws. Above this circle there is a plate, *A*, movable about a vertical axis, and supporting, by means of two columns, a second graduated circle, *M*, which measures the inclination. The needle rests on a frame, *r*,

and the diameter passing through the two zeros of the circle,  $M$ , can be ascertained to be perfectly horizontal by means of the spirit level,  $n$ .

To observe the inclination, the magnetic meridian must first be determined, which is effected by turning the plate  $A$  on the circle  $m$ , until the needle is vertical, which is the case when it is in a plane at right angles to the magnetic meridian (680). The plate  $A$  is then turned  $90^\circ$  on the circle

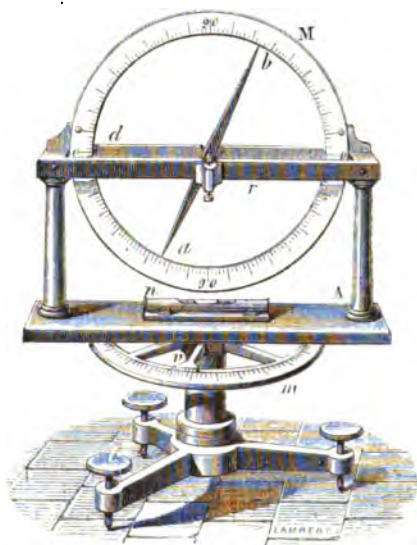

Fig. 549.

$m$ , by which the vertical circle,  $M$ , is brought into the magnetic meridian. The angle,  $dca$ , which the magnetic needle makes with the horizontal diameter is the angle of inclination.

There are here several sources of error, which must be allowed for. The most important are these:—i. The magnetic axis of the needle may not coincide with its axis of figure: hence an error, which is corrected by a method of reversion analogous to that already described (678). ii. The centre of gravity of the needle may not coincide with the axis of suspension, and then the angle,  $dca$ , is too great or too small, according as the centre of gravity is below or above the centre of suspension; for in the first case the action of gravity is in the same direction as that of magnetism, and in the second it is in the opposite direction. To correct this error, the poles of the needle must be reversed by first demagnetising it, and then imparting a contrary magnetism to what it had at first. The inclination is now re-determined, and the mean taken of the results obtained in the two groups of operations. iii. The plane of the ring may not coincide with the true magnetic meridian. It should be in that plane when the needle has its minimum deviation; an observation of this kind should therefore be taken along with

that previously described, by which the needle is moved  $90^\circ$  from its maximum deviation.

The dipping-needle may be used to determine the inclination in another way. It is first allowed to oscillate in the magnetic meridian, and then in a plane at right angles to it. If the number of oscillations in a given time in the first position be  $n$ , and in the second position  $n'$ , then in the first position the whole force of the earth's magnetism,  $E$ , acts, and in the second position only the vertical component which is  $E \sin x$ ,  $x$  being the angle of dip. Now, since the forces acting on the needle are from the laws of the pendulum as the squares of the number of oscillations, we have  $\frac{E}{E \sin x} = \frac{n^2}{n'^2}$

from which  $\sin x = \frac{n'}{n}$

682. **Astatic needle and astatic system.**—An *astatic needle* is one which is uninfluenced by the earth's magnetism. A needle movable about an axis in the plane of the magnetic meridian and parallel to the inclination would be one of this kind; for the terrestrial magnetic couple acting then in the direction of the axis cannot impart to the needle any determinate direction.

An *astatic system* is a combination of two needles of the same force joined parallel to each other with the poles in contrary directions, as shown in fig. 550. If the two needles have exactly the same magnetic force, the opposite action of the earth's magnetism on the poles  $a'$  and  $b$  and on the poles  $a$  and  $b'$  counterbalance each other; the system is then completely astatic, and sets at right angles to the magnetic meridian.

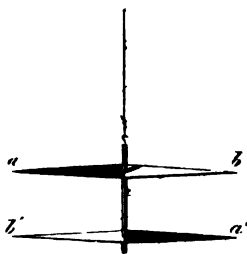

Fig. 550.

A single magnetic needle may also be rendered astatic by placing a large magnet near it. By repeated trials a certain position and distance can be found at which the action of the magnet on the needle just neutralises that of the earth's magnetism, and the needle is free to obey any third force.

683. **Intensity of the earth's magnetism.**—If a magnetic needle be moved from its position of equilibrium, it will revert to it after a series of oscillations, which follow laws analogous to those of the pendulum (81). If the magnet be removed to another place, and caused to oscillate during the same length of time as the first, a different number of oscillations will be observed. And the intensity of the earth's magnetism in the two places will be respectively proportional to the squares of the number of oscillations.

If at  $M$  the number of oscillations in a minute had been  $25 = n$ , and at another place,  $M'$ ,  $24 = n'$ , we should have—

$$\frac{\text{Intensity of the earth's magnetism at } M}{\text{Intensity of the earth's magnetism at } M'} = \frac{n^2}{n'^2} = \frac{625}{576} = 1.085.$$

That is, if the intensity of the magnetism at the second place is taken as unity, that of the first is 1.085. If the magnetic condition of the needle had not changed in the interval between the two observations, this method would give the relation between the intensities at the two places.

In these determinations of the intensity, it would be necessary to have the

oscillations of the dipping-needle, which are produced by the whole force of the earth's magnetism. These, however, are difficult to obtain with accuracy, and, therefore, the oscillations of the declination needle are usually taken. The force which makes the declination needle oscillate is only a portion of the total magnetic force, and is smaller in proportion as the inclination is greater. If a line  $ac$  (fig. 551) =  $M$  represents the total intensity, the angle  $i$  the inclination, then the horizontal component  $ab$  is  $M \cos i$ . Hence to express the intensities in the two places by the oscillations of the declination needle, we must substitute in the preceding equation the values  $M \cos i$  and  $M' \cos i'$  for  $M$  and  $M'$ , and we have—

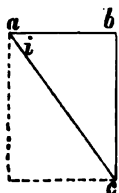

Fig. 551.

$$\frac{M \cos i}{M' \cos i'} = \frac{n^2}{n'^2}; \text{ hence } \frac{M}{M'} = \frac{n^2 \cos i'}{n'^2 \cos i}.$$

That is to say, having observed in two different places the number of oscillations,  $n$  and  $n'$ , that the same needle makes in the same time, the ratio of the magnetic force in the two places will be found by multiplying the ratio of the square of the number of oscillations by the inverse ratio of the cosine of the angle of dip.

The magnetic intensity increases with the latitude. Humboldt found a point of minimum intensity on the magnetic equator in Northern Peru. In the following table this has been taken as the standard to which the magnetic intensities of the other places specified is referred:—

Locality	Date	Latitude	Magnetic Intensity
St. Anthony . . . . .	1802	0°0'	1·087
Carthagena . . . . .	1801	10°25 N.	1·294
Naples . . . . .	1805	40°50	1·274
Paris . . . . .	1800	48°52	1·348
Berlin . . . . .	1829	52°51	1·366
Petersburg . . . . .	1828	59°66	1·410
Spitzbergen . . . . .	1823	79°40	1·567

According to Gauss the total magnetic action of the earth is the same as that which would be exerted if in each cubic yard there were eight bar magnets each weighing a pound.

The lines connecting places of equal intensity are called *isodynamic lines*. They are not parallel to the magnetic equator, but appear to have about the same direction as the isothermal lines. According to Kuppfer, the intensity appears to diminish as the height of the place is greater; a needle which made one oscillation in 24" vibrated more slowly by 0·01" at a height of 1,000 feet; but, according to Forbes, the intensity is only  $\frac{1}{1000}$  less at a height of 3,000 feet. There is, however, some doubt as to the accuracy of these observations, owing to the uncertainty of the correction for temperature.

The intensity varies in the same place with the time of day; it attains its maximum between 4 and 5 in the afternoon, and is at its minimum between 10 and 11 in the morning.

It is probable, though it has not yet been ascertained with certainty, that

the intensity undergoes secular variations. From measurements made at Kew, it appears that, on the whole, the total force experiences a very slight annual increase.

684. **Magnetic observatories.**—During the last few years great attention has been devoted to the observation of the magnetic elements, and observatories for this purpose have been fitted up in different parts of the globe. These observations have led to the discovery that the magnetism of the earth is in a state of constant fluctuation, like the waves of the sea. And in studying the variations of the declination, etc., the mean of a great number of observations must be taken, so as to eliminate the irregular disturbances, and bring out the general laws.

The principle on which magnetic observations are automatically recorded is as follows. Suppose that in a dark room a bar magnet is suspended horizontally, and at its centre is a small mirror; suppose further that a lamp sends a ray of light to this mirror, the inclination of which is such, that the ray is reflected and is received in a horizontal drum placed underneath the lamp. The axis of the drum is at right angles to the axis of the magnet; it is covered with sensitive photographic paper, and is rotated uniformly by clockwork.

If now the magnet is quite stationary, and the drum rotates, the reflected spot of light will trace a straight line on the paper with which the revolving drum is covered. But if, as is always the case, the position of the magnet varies during the twenty-four hours, the effect will be to trace a sinuous line on the paper. These lines can afterwards be fixed by ordinary photographic methods.

Knowing the distance of the mirror from the drum, and the length of the paper band which comes under the influence of the spot of light in a given time, twenty-four hours for instance, the angular deflection at any given moment may be deduced by a simple calculation (508).

The observations made in the English magnetic observatories have been reduced by Sabine, and have revealed some curious facts in reference to the magnetic storms. He finds that there is a certain periodicity in their appearance and that they attain their greatest frequency about every ten years. Independently of this, Schwabe, a German astronomer, who had studied the subject many years, has found that the spots on the sun, seen on looking at it through a coloured glass, vary in their number, size, and frequency, but attain their maximum between every ten or eleven years. Now Sabine has established the interesting fact that the period of their greatest frequency coincides with the period of greatest magnetic disturbance. Other remarkable connections between the sun and terrestrial magnetism have been observed; one, especially, of recent occurrence has attracted considerable attention. It was the flight of a large luminous mass across a vast sun spot, while a simultaneous perturbation of the magnetic needle was observed in the observatory at Kew; subsequent examination of magnetic observations in various parts of the world showed that within a few hours one of the most violent magnetic storms ever known had prevailed.

Magnetic storms are nearly always accompanied by the exhibition of the aurora borealis in high latitudes; that this is not universal may be due to the fact that many auroræ escape notice. The converse of this is true,

that no great display of the aurora takes place without a violent magnetic storm.

The centre or focus towards which the rays of the aurora converge lies approximately in the prolongation of the direction of the dipping needle.

### CHAPTER III.

#### LAWS OF MAGNETIC ATTRACTIONS AND REPULSIONS.

685. **Law of decrease with distance.**—Coulomb discovered the remarkable law in reference to magnetism, *that magnetic attractions and repulsions are inversely as the squares of the distances.* He proved this by means of two methods:—(i.) that of the torsion balance, and (ii.) that of oscillation.

686. i. **The torsion balance.**—This apparatus depends on the principle that, when a wire is twisted through a certain space, the angle of torsion is proportional to the force of torsion (90). It consists (fig. 552) of a

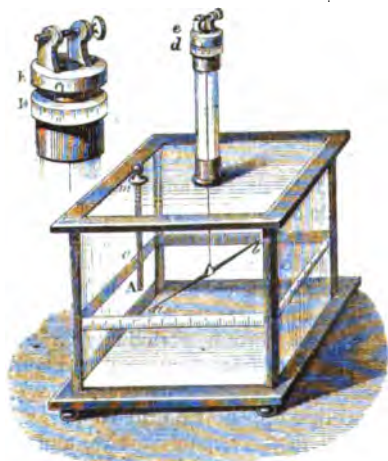

Fig. 552.

the case there is a graduated scale, which indicates the angle of the needle *ab*, and hence the torsion of the wire.

When the mark *c* of the disc *E* is at zero of the scale, *D*, the case is so arranged that the wire supporting the needle and the zero of the scale in the case are in the magnetic meridian. The needle is then removed from its stirrup, and replaced by an exactly similar one of copper, or any unmagnetic substance; the tube, and with it the pieces *D* and *E*, are then turned so that the needle stops at zero of the graduation. The magnetic needle, *ab*, being now replaced, is exactly in the magnetic meridian, and the wire exerts no torsion.

Before introducing the magnet, *A*, it is necessary to investigate the action

proportional to the force of torsion (90). It consists (fig. 552) of a glass case closed by a glass top, with an aperture near the edge, to allow the introduction of a magnet, *A*. In another aperture in the centre of the top a glass tube fits, provided at its upper extremity with a micrometer. This consists of two circular pieces: *d*, which is fixed, is divided on the edge into  $360^\circ$ , while on one *e*, which is movable, there is a mark, *c*, to indicate its rotation. *D* and *E* represent the two pieces of the micrometer on a larger scale. On *E* there are two uprights connected by a horizontal axis, on which is a very fine silver wire supporting a magnetic needle, *ab*. On the side of

of the earth's magnetism on the needle  $ab$ , when the latter is removed out of the magnetic meridian. This will vary with the dimensions and force of the needle, with the dimensions and nature of the particular wire used, and with the intensity of the earth's magnetism in the place of observation. Accordingly, the piece  $E$  is turned until  $ab$  makes a certain angle with the magnetic meridian. Coulomb found in his experiments that  $E$  had to be turned  $35^\circ$  in order to move the needle through  $1^\circ$ ; that is, the earth's magnetism was equal to a torsion of the wire corresponding to  $35^\circ$ . As the force of torsion is proportional to the angle of torsion, when the needle is deflected from the meridian by 2, 3 . . . degrees, the directive action of the earth's magnetism is equal to 2, 3 . . . times  $35^\circ$ .

The action of the earth's magnetism having been determined, the magnet  $A$  is placed in the case so that similar poles are opposite each other. In one experiment Coulomb found that the pole  $a$  was repelled through  $24^\circ$ . Now the force which tended to bring the needle into the magnetic meridian was represented by  $24^\circ + 24 \times 35 = 864$ , of which the part  $24^\circ$  was due to the torsion of the wire, and  $24 \times 35^\circ$  was the equivalent in torsion of the directive force of the earth's magnetism. As the needle was in equilibrium, it is clear that the repulsive force which counterbalanced those forces must be equal to  $864^\circ$ . The disc was then turned until  $ab$  made an angle of  $12^\circ$ . To effect this, eight complete rotations of the disc were necessary. The total force which now tended to bring the needle into the magnetic meridian was composed of:—1st, the  $12^\circ$  of torsion by which the needle was distant from its starting point; 2nd, of  $8 \times 360^\circ = 2880$ , the torsion of the wire; and, 3rd, the force of the earth's magnetism, represented by a torsion of  $12 \times 35^\circ$ . Hence, the forces of torsion which balance the repulsive forces exerted at a distance of  $24^\circ$  and of  $12^\circ$  are—

$24^\circ$	.	.	.	.	864
$12^\circ$	.	.	.	.	3312

Now, 3312 is very nearly four times 864; hence, for half the distance the repulsive force is four times as great.

687. ii. **Method of oscillations.**—A magnetic needle oscillating under the influence of the earth's magnetism may be considered as a pendulum, and the laws of pendulum motion apply to it. The method of oscillations consists in causing a magnetic needle to oscillate first under the influence of the earth's magnetism alone, and then successively under the combined influence of the earth's magnetism, and of a magnet placed at unequal distances.

The following determination by Coulomb will illustrate the use of the method. A magnetic needle was used which made 15 oscillations in a minute under the influence of the earth's magnetism alone. A magnetic bar about 2 feet long was then placed vertically in the plane of the magnetic meridian, so that its north pole was downwards and its south pole presented to the north pole of the oscillating needle. He found that at a distance of 4 inches the needle made 41 oscillations in a minute, and at a distance of 8 inches 24 oscillations. Now, from the laws of the pendulum (55), the intensity of the forces are inversely as the squares of the times of oscillations. Hence, if we call  $M$  the force of the earth's magnetism,  $m$  the attractive force of the magnet at the distance of 4 inches,  $m'$  at the distance of 8 inches, we have



$$M : M + m = 15^2 : 41^2, \text{ and}$$

$$M : M + m' = 15^2 : 24^2,$$

eliminating  $M$

$$m : m' = 41^2 - 15^2 : 24^2 - 15^2 = 1456 : 351$$

$$= 4 : 1 \text{ nearly,}$$

or

$$m : m' = 4 : 1.$$

In other words, the force acting at 4 inches is quadruple that which acts at double the distance.

The above results do not quite agree with the numbers required by the law of inverse squares. But this could only be expected to apply in the case in which the repulsive or attractive force is exerted between two points, and not, as is here the case, between the resultant of a system of points. And it is to this fact that the discrepancy between the theoretical and observed results is due.

When a magnet acts upon a mass of soft iron, the law of the variation with the distance is modified. The attraction in this case is inversely proportional to the distance between the magnet and the iron.

When the distance between the magnet and iron is small, Tyndall has found that the attraction is directly proportional to the square of the strength of the magnet : but when the iron and the magnet are in contact, then the attraction is directly proportional to the strength of the magnet.

688. **Magnetic curves.**—If a stout sheet of paper stretched on a frame be held over a horse-shoe magnet, and then some very fine iron filings be

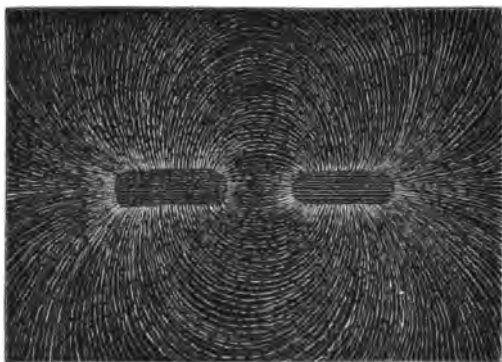

Fig. 553.

strewn on the paper, on tapping the frame the filings will be found to arrange themselves in thread-like curved lines, stretching from pole to pole (fig. 553). These lines form what are called *magnetic curves*. The direction of the curve at any point represents the direction of the magnetism at this point.

To render these curves permanent, the paper on which they are formed should be waxed ; if then a hot iron plate be held over them, this melts the wax, which rises by capillary attraction (132) between the particles of filings, and on subsequent cooling connects them together.

These curves are a graphic representation of the law of magnetic attrac-

tion and repulsion with regard to distance ; for under the influence of the two poles of the magnet, each particle itself becomes a minute magnet, the poles of which arrange themselves in a position dependent on the resultant of the forces exerted upon them by the two poles, and this resultant varies with the distance of the two poles respectively. A small magnetic needle placed in any position near the magnet will take a direction which is the tangent to the curve at this place.

689. **Magnetic field.**—The space in the immediate neighbourhood of any magnet undergoes some change, in consequence of the presence of this magnet, and such a space is spoken of as a *magnetic field*; the effect produced by the magnet is often said to be due to the magnetic field. Magnets of different powers produce magnetic fields of different intensity.

The direction which represents the resultant of the magnetic forces in a magnetic field is spoken of as the direction of the *lines of force* of this field. In the above figure the magnetic curves represent the direction of the lines of force in the field due to the two poles.

A uniform magnetic field is one in which the lines of force are parallel. This is practically the case with a field at some distance from a long thin magnet of uniform magnetisation.

The dipping needle, when free to oscillate in a vertical plane in the magnetic meridian, represents the direction of the lines of force due to the terrestrial magnetic field. This field in any one place is uniform.

690. **Total action of two magnets on each other.**—In the above case of the torsion balance one pole of the magnet to be tested, was at so great a distance that it could not appreciably modify the influence of the other. When, however, the conditions are such that both poles act, then they follow a different law, as will now be demonstrated.

Let *ns* (fig. 554) be a small magnetic needle, free to move in a horizontal plane, and let *NS* be a bar magnet placed at right angles to the magnetic meridian, at a distance which is great compared with its own dimensions, and so that the straight line drawn through its middle point and that of the needle coincides with the magnetic meridian. The two poles *S* and *s* will repel each other in the direction *sa*; if *mm'*, is the repellent force which these two poles would exert at the unit distance, then

$\frac{mm'}{r^2}$  is the force which they would exert at the distance

$Ss = r$ ; let this force be represented in direction and strength by the line *sa*. Similarly, the pole *N* will act on *s*, with a force represented by the line *sc*; *S* and *N* being at the same distance *r* from *s*, *sa* and *sc* are equal, and their resultant may be represented by the line *sb*. From the similarity of the triangles *bsa* and *NSs* we have the proportion  $Ss : SN = as : bs$ ; if *f* is the value of the resultant *bs*, that is the total action of the magnet *SN* on the pole *S*, and if *l* be half the length of the magnet *SN*, we have  $r : 2l =$

$\frac{mm'}{r^2} : f$ , from which  $f = \frac{2mm'l}{r^3}$ , that is, the total action of the

magnet *NS* upon another is inversely as the cube of the distance *r*.

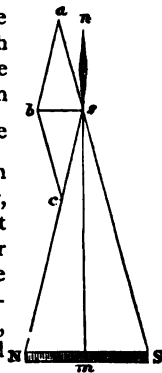

Fig. 554.

If the two magnets be placed as represented in figure 555, the needle being in the magnetic meridian, and the deflecting magnet at right angles

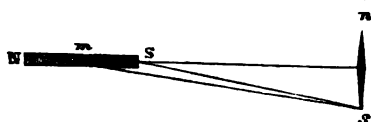

Fig. 555.

thereto, and so that the prolongation of its axis bisects the needle, then if  $mm$ , is the force with which the pole N attracts the pole  $s$  at the unit distance,  $m$  and  $m$ , being the strength of the poles in the bar magnet, and the magnetic needle respectively; the attracting force at the distance  $Ns$  will be  $\frac{mm}{(r+l)^2}$ ,  $l$  being as before the half length of the magnet, and  $r$  the distance of the pole  $s$  from the middle of the magnet  $NS$ ; in like manner the repellent force with which  $S$  acts upon  $s$  will be  $\frac{mm}{(r-l)^2}$ . If  $ns$  is small compared with the distance of the bar magnet  $NS$ , the direction of these forces may be assumed to be parallel, and at right angles to  $ns$ . Since  $S$  is nearer than  $N$  the repulsion will predominate, and the total force with which the magnet  $NS$  acts on the pole  $s$  is

$$F = \frac{mm}{(r-l)^2} - \frac{mm}{(r+l)^2}$$

which, assuming that  $l$  is so small in comparison with  $r$  that its square and higher powers may be neglected, gives approximately

$$F = 4 \frac{mm}{r^3} l$$

so that compared with the first position of the magnet

$$F = 2f.$$

691. **Determination of magnetism in absolute measure.**—The comparisons of the intensity of the earth's magnetism in different places (683) are only relative. Of late years much attention has been devoted to the method of expressing not only this, but all other magnetic forces in what is called 'absolute measure.' This term is used as opposed to relative, and does not imply that the measure is absolutely accurate, or that the units of comparison employed are of perfect construction; it means that the measurements, instead of being a simple comparison with an arbitrary quantity of the same kind as that measured, are referred to the fundamental units of time, space, and mass (21).

The manner in which this determination is made in the case of magnetism, depends essentially on the observation of the oscillation of a horizontal bar magnet under the influence of the earth's magnetism; and in the second place, on observing the deflection of a magnetic needle under the influence of this same magnet.

When a bar magnet suspended by a thread without torsion, free to oscillate in a horizontal plane, is deflected from its position of equilibrium and

then left to itself, it vibrates backwards and forwards through its position of equilibrium, making oscillations which, if small, are isochronous like those of the pendulum. The number of these oscillations in a given time depends on the mass and dimensions of the bar, on its magnetic power, and on the intensity of the earth's magnetism in the place of observation. The time,  $t$ , of a complete

oscillation of such a magnet is represented by the formula  $t = 2\pi \sqrt{\frac{k}{HM}}$  ;

where  $k$  is the moment of inertia of the magnet, that is the mass which must be concentrated at the unit of distance from the centre of suspension, to present the same resistance to change of angular velocity about this centre as the magnet itself actually does. The moment of inertia of a magnet may be determined theoretically if it be homogeneous in structure, and of a regular geometrical shape; or it may be determined experimentally by first observing the time of oscillation of the magnet under the influence of the earth's magnetism, and then the time when it has been loaded with a mass the inertia of which is known and which does not alter the magnetic moment of the bar.  $M$  is the magnetic moment of the bar itself, and  $H$  is the force of the earth's magnetism. Hence

$$HM = \frac{4\pi^2 k}{t^2}.$$

This expression gives the force which, applied in opposite directions at the ends of a lever of unit length, placed at right angles to the direction of this force, would have the same effect in tending to turn the lever, as the magnetic force of the earth has in tending to turn the magnet about a vertical axis when it is set at right angles to the magnetic meridian.

Now the value of  $HM$  depends on the nature of the bar, and on the force of the earth's magnetism in the place in question. If the bar were magnetised more or less strongly, or if the same bar were removed to a different locality, the product would have a different value. We must, therefore, find some independent relation between  $H$  and  $M$ , which will give rise to a new equation, and thus  $M$ , the magnetic moment of the bar, would be got rid of, and an absolute value be obtained for  $H$ .

Such a relation exists in the deflection from the magnetic meridian, which a bar magnet produces in a magnetic needle.

If in the formula in the preceding article we put  $M = 2ml$ , then  $\frac{2Mm'}{r^3}$  = the + or - force acting on either pole of the magnetic needle, and as both poles are acted on, the magnet will be subject to the action of a couple, the moment of which will be expressed by  $\frac{2Mm'}{r^3} 2l' \cos a$ ; where  $a$  is the angle of deflection,  $l'$  the half-length of the small magnetic needle; let  $M' = 2m'l'$ . In like manner the earth's magnetism will act upon the magnetic needle with a couple the moment of which is expressed by  $Hm' 2l' \sin a = HM' \sin a$ . Now when the needle is in equilibrium these forces are equal; that is—

$$\frac{2MM'}{r^3} \cos a = HM' \sin a,$$

from which  $\frac{2M}{H} = r^3 \tan a$ .

Combining the expressions (1) and (2) we get the expression  $H = \frac{\pi}{t}$

$$H = \frac{\pi}{t} \sqrt{\frac{k}{r^2 \tan a}}$$

an expression which involves no other physical units than those of length (involved in  $k$  and  $r$ ), mass (involved in  $k$ ), and time (involved in  $t$ ), so that the value of  $H$  can be expressed in absolute measure.

The expression for  $H$  in this expression only gives the horizontal component of the earth's magnetism; the total force is obtained by dividing the value of  $H$  by the cosine of the angle of dip for the place and time of observation.

The numerical value of  $H$  will depend, moreover, on the units taken. On the *centimetre-gramme-second* system the unit of force is called a *dyne*. It is the force which acting upon a gramme for a second generates a velocity of a centimetre per second. The value of  $H$  at Greenwich for the year 1877, expressed in this unit, is 0.18079 of a dyne; that is, the horizontal component of the earth's magnetism at this place acting on the unit of magnetism, associated with one gramme of matter, would produce a velocity of 0.18079 centimetres at the end of a second. The angle of dip at this place being  $67^\circ 37'$ , we get the total force = 0.4745 units. If British units—namely the foot, grain, second—be employed, the unit of force is that which by acting for a second on a grain gives to it a velocity of a foot per second, and the unit magnetic pole is such that if placed one foot from a second equal pole it will repel it with a force equal to the unit just defined. To convert the value of  $H$  when expressed in centimetres, grammes, and seconds into the equivalent value referred to British units, we must multiply by 21.69. In like manner to convert magnetic forces referred to British units into the corresponding values expressed in centimetres, grammes, and seconds we must multiply by  $0.0461 = \frac{1}{21.69}$ .

## CHAPTER IV.

### PROCESSES OF MAGNETISATION.

692. **Magnetisation.**—The various sources of magnetism are the influence of natural or artificial magnets, terrestrial magnetism, and electricity. This last method will be described under voltaic electricity. The three principal methods of magnetisation by magnets are known by the technical names of *single touch*, *separate touch*, and *double touch*.

693. **Method of single touch.**—This consists in moving the pole of a powerful magnet from one end to the other of the bar to be magnetised, and repeating this operation several times always in the same direction. The neutral fluid is thus gradually decomposed throughout all the length of the bar, and that end of the bar which was touched last by the magnet is of opposite polarity to the end of the magnet by which it has been touched. This method only produces a feeble magnetic power, and is, accordingly, only

used for small magnets. It has further the disadvantage of frequently developing consequent poles.

694. **Method of separate touch.**—This method, which was first used by Dr. Knight in 1745, consists in placing the two opposite poles of two magnets of equal force in the middle of the bar to be magnetised, and in moving each of them simultaneously towards the opposite ends of the bar. Each magnet is then placed in its original position, and the operation repeated. After several frictions on both faces of the bar it is magnetised.

In Knight's method the magnets are held vertically. Duhamel improved the method by inclining the magnets, as represented in fig. 556; and still more, by placing the bar to be magnetised on the opposite poles of two fixed magnets, the action of which strengthens that of the movable magnets. The relative position of the poles of the magnets is indicated in the figure. This method produces the most regular magnets.

695. **Method of double touch.**—In this method, which was invented by Mitchell, the two magnets are placed with their poles opposite each other in the middle of the bar to be magnetised. But, instead of moving them in opposite directions towards the two ends, as in the method of separate touch, they are kept at a fixed distance by means of a piece of wood placed between them (fig. 556), and are simultaneously moved first towards one end, then from

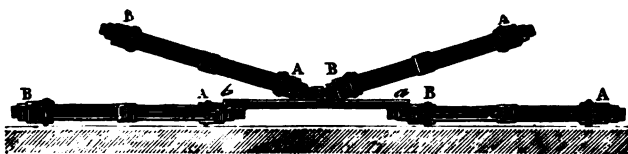

Fig. 556.

to the other end, repeating this operation several times, and finishing in the middle, taking care that each half of the bar receives the same number of frictions.

Epinus, in 1758, improved this method by supporting the bar to be magnetised, as in the method of separate touch, on the opposite poles of two powerful magnets, and by inclining the bars at an angle of  $15^{\circ}$  to  $20^{\circ}$ . In practice, instead of two bar magnets, it is usual to employ a horse-shoe magnet, which has its poles conveniently close together.

By this method of double touch, which is the one generally adopted, powerful magnets are obtained, but they have frequently consequent poles. As this would be a serious injury to compass needles, these are best magnetised by separate touch.

696. **Magnetisation by the action of the earth.**—The action of the earth on magnetic substances resembles that of a magnet, and hence the terrestrial magnetism is constantly tending to separate the two magnetisms which are in the neutral state in soft iron and in steel. But as the coercive force is very considerable in the latter substance, the action of the earth is inadequate to produce magnetisation, except when continued for a long time. This is not the case with perfectly soft iron. When a bar of this metal is held in the magnetic meridian parallel to the inclination, the bar becomes at

once endowed with feeble magnetic polarity. The lower extremity is a north pole, and if the north pole of a small magnetic needle be approached, it will be repelled. This magnetism is of course unstable, for if the bar be turned the poles are inverted, as pure soft iron is destitute of coercive force.

While the bar is in this position, a certain amount of coercive force may be imparted to it by giving it several smart blows with a hammer, and the bar retains for a short time the magnetism which it has thus obtained. But the coercive force thus developed is very small, and after a time the magnetism disappears.

If a bar of soft iron be twisted while held vertically, or, better, in the plane of the dip, it acquires a feeble permanent magnetism.

It is this magnetising action of the earth which develops the magnetism frequently observed in steel and iron instruments, such as fire-irons, rifles, lamp-posts, railings, gates, lightning conductors, etc., which remain for some time in a more or less inclined position. They become magnetised with their north pole downward, just as if placed over the pole of a powerful magnet. The magnetism of native black oxide of iron has doubtless been produced by the same causes; the very different magnetic power of different specimens being partly attributable to the different positions of the veins of ore with regard to the line of dip. The ordinary irons of commerce are not quite pure, and possess a feeble coercive force; hence a feeble magnetic polarity is generally found to be possessed by the tools in a smith's shop. Cast iron, too, has usually a great coercive force, and can be permanently magnetised. The turnings, also, of wrought iron and of steel produced by the powerful lathes of our ironworks are found to be magnetised.

697. **Magnetism of iron ships.**—The inductive action of terrestrial magnetism upon the masses of iron always found in ships exerts a disturbing action upon the compass needle. The *local attraction*, as it is called, may be so considerable as to render the indications of the needle almost useless if it be not guarded against. A full account of the manner in which local attraction is produced, and in which it is compensated, is inconsistent with the limits of this book, but the most important points are the following :—

i. A vertical mass of soft iron in the vessel, say in the bows, would become magnetised under the influence of the earth; in the northern hemisphere, the lower end would be a north pole, and the upper end a south pole; and as the latter may be assumed to be nearer the north pole of the compass needle, it would act upon it. So long as the vessel was sailing in the magnetic meridian this would have no effect; but in any other direction the needle would be drawn out of the magnetic meridian, and a little consideration will show that when the ship was at right angles to the magnetic meridian the effect would be greatest. This *vertical induction* would disappear twice in swinging the ship round, and would be at its maximum twice; hence the deviation due to this cause is known as *semicircular deviation*.

ii. Horizontal masses again, such as deck-beams, are also acted upon inductively by the earth's magnetism, and their induced magnetism exerts a disturbing influence upon the magnetic needle. The effect of this horizontal induction will disappear when the ship is in the magnetic meridian

and also when it is at right angles thereto. In positions intermediate to the above the disturbing influence will attain its maximum. Hence in swinging a ship round there would be four positions of the ship's head in which the influence would be at a maximum and four in which it would be at a minimum. The effect of horizontal induction is accordingly spoken of as *quadrantal deviation*.

The influence of both these causes, vertical and horizontal induction, may be remedied in the process of 'swinging the ship.' This consists in comparing the indications of the ship's compass with those of a standard compass placed on shore. The ship is then swung round in various positions, and by arranging small vertical and horizontal masses of soft iron in proximity to the steering compass, positions are found for them in which the inductive action of the earth upon them quite neutralises the influence of the earth's magnetism upon the ship; and in all positions of the ship, the compass points in the same direction as the one on shore.

iii. The extended use of iron in ship-building, more especially when the frames are entirely of iron, has increased the difficulty. In the process of building a ship, the hammering and other mechanical operations to which it is subject, while under the influence of the earth's magnetism, will cause it to become to a certain extent permanently magnetised. The distribution of the magnetism, the direction of its magnetic axis, will depend on the position in which it has been built; it may or may not coincide with the direction of the keel. The vessel becomes in short a huge magnet, and will exert an influence of its own upon the compass quite independently of vertical or horizontal induction. This influence is *semicircular*; that is, it disappears when the magnetic axis of the ship is in the magnetic meridian and is greatest at right angles to it. It may be compensated by two permanent magnets placed near the compass in suitable positions found by trial during the process of swinging the ship. Supposing the inherent magnetism of the ship to have the power of drawing the compass a point to the east, the compensating magnets may be so arranged as to tend to draw it a point to the west, and thus keep it in the magnetic meridian. If, however, the inherent magnetism be destroyed, from whatever cause, it is clear that the magnets will now draw it aside a point too much to the west. This is the source of a new difficulty. It has been found that a ship which at the time of sailing was properly compensated would on returning from a long voyage have its compasses over-compensated. The buffeting which the ship had experienced had destroyed its inherent magnetism, and numerous instances are known where the loss of a vessel can be directly traced to this cause. Fortunately, it has been found that after some time a ship's magnetic condition is virtually permanent, and is unaltered by any further wear and tear. The magnetism which it then retains is called its *permanent* magnetism, in opposition to the *sub-permanent* which it loses.

The difficulty of adequately compensating compasses, which is greatly increased by the armour-plated and turret ships now in use, has induced one school to throw over any attempt at correction; but by careful observation of the magnetic condition of a ship, and tabulating the errors to construct a table, and comparing this with the indications of the compass at any one time, the true course can be made out.



In the Royal Navy, the plan now adopted is to combine both methods : compensate the errors to a considerable extent, and then construct a table of the residual errors.

698. **Saturation.**—Experiment has shown that to a certain extent the magnetic force which can be imparted to a steel bar increases with the magnetising force used. It depends also on the number of strokes or movements of the magnetising coils ; on the forms and dimensions of the bar, on its density, on the quantity of carbon it contains, on its hardness, and on the manner in which it is tempered. Yet there is a limit to the magnetic force which can be imparted to iron or steel, and when this is attained, the bar is said to be *saturated or magnetised to saturation*. A bar may indeed be magnetised beyond this point, but this excess is *temporary*, it gradually diminishes until the magnet has sunk to its point of saturation.

This is intelligible, for the magnetisms once separated tend to reunite, and when their attractive force is equal to that which opposes their separation, that is, the coercive force of the metal, equilibrium is attained, and the magnet is saturated. Hence, more magnetism ought to be developed in bars than they can retain, in order that they may decline to their permanent state of saturation. To increase the magnetism of an unsaturated bar, a less feeble magnet must not be used than that by which it was originally magnetised.

699. **Magnetic battery.**—A *magnetic battery or magazine* consists of a number of magnets joined together by their similar poles. Sometimes they have the form of a horse-shoe, and sometimes a rectilinear form. The battery represented in fig. 557 consists of five superposed steel plates. That



Fig. 557.

in fig. 558 consists of twelve plates, arranged in three layers of four each. The horse-shoe form is best adapted for supporting a weight, for then both poles are used at once. In both the bars are magnetised separately, and then fixed by screws.

The force of a magnetic battery consisting of  $n$ , similar plates equally magnetised is not  $n$  times as great as that of a single one but is somewhat smaller. These magnets mutually enfeeble each other ; manifestly because, for instance, each north pole evokes south magnetism in the adjacent north pole, and thereby diminishes some of its north polarity. The magnetism of a plate which has formed part of such a battery will be found to be materially less than it was originally.

Thus I am informed that six equal plates which had each the portative force 18 kilos, only lifted 64 kilos when arranged as a battery, instead of 108 ; and when removed from the battery, each of them had only the portative force

9 to 10 kilos. The force is increased by making the lateral plates 1 or 2 centimetres shorter than the one in the middle (fig. 557).

700. **Armatures.**—When even a steel bar is at its limit of saturation, it gradually loses its magnetism. To prevent this, *armatures* or *keepers* are used; these are pieces of soft iron, A and B (fig. 558), which are placed in



Fig. 558.

contact with the poles. Acted on inductively, they become powerful temporary magnets, possessing opposite polarity to that of the inducing pole; they thus react in turn on the permanent magnetism of the bars, preserving and even increasing it.

When the magnets are in the form of bars, they are arranged in pairs, as shown in fig. 559, with opposite poles in juxtaposition, and the circuit is

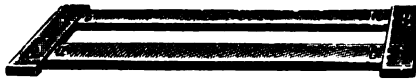

Fig. 559.

completed by two small bars of soft iron, AB. Movable magnetic needles set spontaneously towards the magnetic poles of the earth, the influence of which acts as a keeper.

A horse-shoe magnet has a keeper attached to it, which is usually arranged so as to support a weight. The keeper becomes magnetised under the influence of the two poles, and adheres with great force; the weight which it can support being much more than double that which a single pole would hold.

In respect to this weight, a singular and hitherto inexplicable phenomenon has been observed. When contact is once made, and the keeper is charged with its maximum weight, any further addition would detach it; but if left in contact for a day, an additional weight may be added without detaching it, and by slightly increasing the weight every day, it may ultimately be brought to support a far greater load than it would originally. But if contact be once broken, the weight it can now support does not much exceed its original charge.

It is advantageous that the surfaces of the magnet and armatures which are in contact should not be plane, but slightly cylindrical, so that they touch along a line.

In providing a natural magnet with a keeper, the line joining the two poles is first approximately determined by means of iron filings. Two poles of soft iron (fig. 560), each terminating in a massive shoe, are then applied



Fig. 560.

to the faces corresponding to the poles. Under the influence of the natural magnet, these plates become magnetised, and if the letters A and B represent the position of the poles of the natural magnet, the poles of the armature are *a* and *b*.

701. **Portative Force. Power of magnets.**—The *portative force* is the greatest weight which a magnet can support. Häcker found that the portative force of a saturated horse-shoe magnet, which, by repeatedly detaching the keeper, has become constant, may be represented by the formula

$$P = a\sqrt{p'}$$

in which *P* is the portative force of the magnet, *p* its own weight, and *a* a coefficient which varies with the nature of the steel and the mode of magnetising. Hence a magnet which weighs 1,000 ounces only supports 25 times as much as one weighing 8 ounces or  $\frac{1}{125}$  as heavy, and 125 such bars would support as much as one which is as heavy as all together. It appears immaterial whether the section of the bar is quadratic or circular, and the distance of the legs is of inconsiderable moment; it is important, however, that the magnet be suspended vertically, and that the load be exactly in the middle. In Häcker's magnets the value of *a* was 10.33, while in Logemann's it was 23. By arranging together several thin plates magnetised to saturation Jamin has constructed bar magnets which support 15 times their own weight.

The strength of two bar magnets may be compared by the following simple method, which is known as Külp's *compensation method*:—A small magnetic compass needle is placed in the magnetic meridian. One pole of one of the magnets to be tested is then placed at right angles to the magnetic meridian in the same plane as the needle, and so that its axis prolonged would bisect the needle. The compass needle is thereby deflected through a certain angle. The similar pole of the other magnet is then placed similarly on the other side of the needle, and a position found for it in which it exactly neutralises the action of the first magnet, that is, when the needle is again in the magnetic meridian. If the magnets are not too long, compared with their distance from the needle, their strengths are approximately as the cubes of the distance of the acting poles from the magnetic needle.

702. **Circumstances which influence the power of magnets.**—All bars do not attain the same state of saturation, for their coercive force varies. Twisting or hammering imparts to iron or steel a considerable coercive force. But the most powerful of these influences is the *operation of tempering* (95). Coulomb found that a steel bar tempered at dull redness and magnetised to saturation, made ten oscillations in 93 seconds. The same bar tempered at a cherry-red heat, and similarly magnetised to saturation, only took 63 seconds to make ten oscillations.

Hence it would seem, the harder the steel the greater is its coercive force; it receives magnetism with much greater difficulty, but retains it more effectually. It appears from Jamin's experiments that no general rule of this kind can be laid down; for each specimen of steel there seems, according to the proportion of carbon which it contains, to be a certain degree of tempering which is most favourable for the development of permanent magnetisation.

The hardness of steel and the proportion of carbon which it contains exert an important influence on the degree to which it can be magnetised. For the same degree of hardness the magnetisation increases with the proportion of carbon in the steel, and more markedly the smaller this proportion; with the same proportion of carbon it increases with the hardness of the steel. It appears that the compound of iron and carbon in steel is the carrier of the permanent magnetism, and the interjacent particles of iron the carriers of the temporary magnetism. Holtz magnetised plates of English corset steel to saturation and determined their magnetic moment; they were then placed in dilute hydrochloric acid, by which the iron was eaten away, and the magnetic moment determined when the plate had been magnetised to saturation after each such treatment. It was thus found that with a diminution in the proportion of iron there was an increase in the magnetic moment for the unit of weight. Holtz found, however, that pure iron prepared by electrolysis can acquire permanent magnetism.

Jamin investigated the distribution of force in magnets by suspending from one arm of a delicate balance a small iron ball, and then ascertaining what force applied at the other arm was required to detach the ball when placed in contact with various positions of the magnet to be investigated.

Taking thus a thin plate magnetised to saturation, it was found that the magnetism increased with the thickness, but did not materially vary with the breadth of the plate. The magnetic force was developed almost exclusively at the ends. The curve representing the magnetic force (703) was convex towards the poles at the ends. If now several similar plates are superposed, the corresponding curves become steeper and prolonged towards the middle; the magnetic force thus becomes increased. When the curves run into each other in the middle the maximum of the combination is reached; any additional plates produce no increase in the strength. Steel bars may also be magnetised so as to show the same curves, and such bars and combinations of plates are called by Jamin *normal magnets*.

Jamin found that magnetisation extends deeper in a bar than has been usually supposed; in soft and annealed steel it penetrates deeply. The depth diminishes with the hardness of the steel and the proportion of carbon it contains. If plates of varying thickness are so thin that the magnetisation can entirely penetrate them, the thicker of these plates are more strongly magnetised by the same force, for the magnetisation extends through a thicker layer than the thinner ones; if, however, the plates are very thick, they are magnetised to the same extent by one and the same force. With equal bars the thickness of the magnetic layer varies with the strength of the magnetising force. Jamin proved this by placing the plates in sulphuric acid; he found magnetism in bars which had been exposed to the stronger force, while those which had been more feebly magnetised showed none when they had been eaten away by the acid to the same extent. He showed in this way that the magnetism which had thus penetrated was as strong as that on the surface. Very hard steel bars have the disadvantage of being very brittle, and in the case of long thin bars a hard tempering is apt to produce consequent poles. Compass needles are usually tempered at the blue heat, that is, about 300° C., by which a high coercive force is obtained without great fragility. Steel is magnetised with difficulty even when placed for some time in a coil

through which a powerful current is passing ; iron under these circumstances is magnetised at once. If a short coil covering only a portion of the steel bars be moved backwards and forwards the magnetisation is more complete.

*Temperature.*—Increase of temperature always produces a diminution of magnetic force. If the changes of temperature are small, those of the atmosphere for instance, the magnet is not permanently altered. Kupffer allowed a magnet to oscillate at different temperatures, and found a definite decrease in its power with increased temperature, as indicated by its slower oscillations. In the case of a magnet  $2\frac{1}{2}$  inches in length, he observed that with an increase of each degree of temperature the duration of 800 oscillations was  $0.4''$  longer. If  $n$  be the number of oscillations at zero, and  $n_1$  the number at  $t$ , then

$$n = n_1 (1 - ct),$$

where  $c$  is a constant depending in each case on the magnet used. This formula has an important application in the correction of the observations of magnetic intensity which are made at different places and at different temperatures, and which, in order to be comparable, must first be reduced to a uniform temperature.

When a magnet has been more strongly heated, it does not regain its original force on cooling to its original temperature, and when it has been heated to redness, it is demagnetised. This was first shown by Coulomb, who took a saturated magnet, and progressively heated it to higher temperatures, and observed the number of oscillations after each heating. The higher the temperature to which it had been heated the slower its oscillations.

A magnet heated to bright redness loses its magnetism so completely that it is quite indifferent, not only towards iron, but also towards another magnet. Incandescent iron also does not possess the property of being attracted by the magnet. Hence there is in the case of iron a *magnetic limit*, beyond which it is unaffected by magnetism. Such a magnetic limit exists in the case of other magnetic metals. With *cobalt*, for instance, it is far beyond a white heat, for at the highest temperatures hitherto examined it is still magnetic ; the magnetic limit of *chromium* is somewhat below red heat ; that of *nickel* at about  $350^\circ$  C., and of *manganese* at about  $15^\circ$  to  $20^\circ$  C.

*Torsion.*—Torsion exerts a great influence on the magnetisation of a bar, and the interesting phenomenon has been observed that torsion influences magnetism in the same manner as magnetism does torsion. Thus the permanent magnetism of a steel bar is diminished by torsion, but not proportionally to the increase of torsion. In like manner the torsion of twisted iron wires is diminished by their being magnetised, though less so than in proportion to their magnetisation. Repeated torsions in the same direction scarcely diminish magnetisation, but a torsion in the opposite direction produces a new diminution of the magnetism. In a perfectly analogous manner, repeated magnetisations in the same sense scarcely diminish torsion, but a renewed magnetisation in the opposite direction does so.

703. **Distribution of free magnetism.**—To investigate the distribution of magnetic force in different parts of a magnet, Coulomb placed a large magnet in a vertical position in the magnetic meridian ; he then took a small magnetic needle suspended by a thread without torsion, and, having

ascertained the number of its oscillations under the influence of the earth's magnetism alone, he presented it to different parts of the magnet. The oscillations were fewer as the needle was nearer the middle of the bar, and when they had reached that position, their number was the same as under the influence of the earth's magnetism alone. He found that with saturated bars of more than 7 inches in length the distribution could always be expressed by a curve whose abscissæ were the distances from the ends of the magnet, and whose ordinates were the force of magnetism at these points. With magnets of the above dimensions the poles are at the same distance from the end; Coulomb found the distance to be 1.6 inch in a bar 8 inches long. The same physicist found that, with shorter bars, the distance of the poles from the end is  $\frac{1}{6}$  of the length; thus with a bar of three inches it would be half an inch.

These results presume that the other dimensions of the bar are very small as compared with its length, that it has a regular shape, and is uniformly magnetised. When these conditions are not fulfilled, the positions of the poles can only be determined by direct trials with a magnetic needle. With lozenge-shaped magnets the poles are nearer the middle. Coulomb found that these lozenge-shaped bars have a greater *directive* force than rectangular bars of the same weight, thickness, and hardness.

## BOOK IX.

## FRICTIONAL ELECTRICITY.

## CHAPTER I.

## FUNDAMENTAL PRINCIPLES.

704. **Electricity. Its nature.**—Electricity is a powerful physical agent which manifests itself mainly by attractions and repulsions, but also by luminous and heating effects, by violent commotions, by chemical decompositions, and many other phenomena. Unlike gravity, it is not inherent in bodies, but it is evoked in them by a variety of causes, among which are friction, pressure, chemical action, heat and magnetism.

Thales, six centuries before Christ, knew that when *amber* was rubbed with silk, it acquired the property of attracting light bodies; and from the Greek form of this word (*ηλεκτρον*, *electron*) the term *electricity* has been derived. This is nearly all the knowledge left by the ancients; and it was not until towards the end of the sixteenth century that Dr. Gilbert, physician to Queen Elizabeth, showed that this property was not limited to amber, but that other bodies, such as sulphur, wax, glass, etc., also possessed it in a greater or less degree.

705. **Development of electricity by friction.**—When a glass rod, or a stick of sealing-wax, or shellac, is held in the hand, and is rubbed with a piece of flannel or with the skin of a cat, the parts rubbed will be found to have the property of attracting light bodies, such as pieces of silk, wool, feathers, paper, bran, gold leaf, etc., which, after remaining a short time in contact, are again repelled. In order to ascertain whether bodies are electrified or not, instruments called *electroscopes* are used. The simplest of these, the *electric pendulum* (fig. 561), consists of a pith ball attached by means of a silk thread to a glass support. When an electrified body is brought near the pith ball, the latter is instantly attracted, but after momentary contact is again repelled (fig. 562).

A solid body may also be electrified by friction with a liquid or with a gas. In the Torricellian vacuum a movement of the mercury against the sides of the glass produces a disengagement of electric light visible in the dark; a tube exhausted of air, but containing a few drops of mercury, becomes also luminous when agitated in the dark.

If a quantity of mercury in a dry glass vessel be connected with a gold-

leaf electroscope by a wire, and a dry glass rod be immersed in it, no indications are observed during the immersion, but on smartly withdrawing the rod, the leaves increasingly diverge, attaining their maximum when the rod leaves the mercury.

Some substances, particularly metals, do not seem capable of receiving the electric excitement. When a rod of metal is held in the hand, and rubbed with silk or flannel, no electrical effects are produced in it; and bodies were

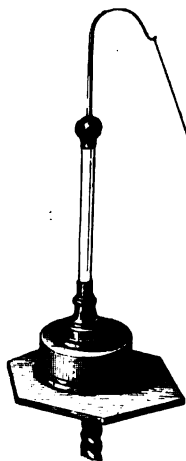

Fig. 561.

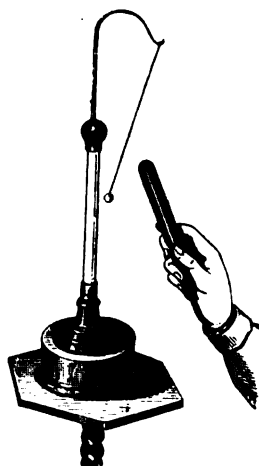

Fig. 562.

divided by Gilbert into *ideoelectrics*, or those which become electrical by friction, and *anelectrics*, or those which do not possess this property. These distinctions no longer obtain in any absolute sense; it will presently be seen that, under appropriate conditions, all bodies may be electrified by friction (707).

With reference to the cause of the production of electricity by friction nothing is known. Wollaston attributed it to oxidation; but Wilson and Gray have shown that electrical phenomena may be produced in vacuo, and Gay-Lussac proved that electricity may be developed in an atmosphere of carbonic acid.

**706. Conductors and nonconductors.**—When a dry glass rod, rubbed at one end, is brought near an electroscope, that part only will be electrified which has been rubbed; the other end will produce neither attraction nor repulsion. The same is the case with a rod of shellac or of sealing-wax. In these bodies electricity does not pass from one part to another—they do not *conduct* electricity. Experiment shows, that when a metal has received electricity in any of its parts, the electricity instantly spreads over its entire surface. Metals are hence said to be good *conductors* of electricity.

Bodies have, accordingly, been divided into *conductors* and *nonconductors* or *insulators*. This distinction is not absolute, and we may advantageously consider bodies as offering a *resistance* to the passage of electricity which



varies with the nature of the substance. Those bodies which offer little resistance are then conductors, and those which offer great resistance are nonconductors or insulators: electrical *conductivity* is thus the inverse of electrical *resistance*. We are to consider that between conductors and nonconductors there is a *quantitative* and not a *qualitative* difference; there is no conductor so good but that it offers some resistance to the passage of electricity, nor is there any substance which insulates so completely but that it allows some electricity to pass. The transition from conductors to nonconductors is gradual, and no line of sharp demarcation can be drawn between them.

In this sense we are to understand the following table, in which bodies are classed as *conductors*, *semiconductors*, and *nonconductors*; those bodies being conveniently designated as conductors which when applied to a charged electroscope discharge it almost instantaneously; semiconductors being those which discharge it in a short but measurable time, a few seconds, for instance; while nonconductors effect no perceptible discharge in the course of a minute.

<i>Conductors.</i>	<i>Semiconductors.</i>	<i>Nonconductors.</i>
Metals.	Alcohol and ether.	Dry oxides.
Well-burnt charcoal.	Powdered glass.	Ice at $-25^{\circ}$ C.
Graphite.	Flour of sulphur.	Lime.
Acids.	Dry wood.	Lycopodium.
Aqueous solutions.	Paper.	Caoutchouc.
Water.	Ice at $0^{\circ}$ .	Air and dry gases.
Snow.		Dry paper.
Vegetables.		Silk.
Animals.		Diamond and precious stones.
Soluble salts.		Glass.
Linen.		Wax.
Cotton.		Sulphur.
		Resins.
		Amber.
		Shellac.

This list is arranged in the order of decreasing conductivity, or what is the same thing, of increasing resistance. The arrangement is not invariable, however. Conductivity depends on many physical conditions. Glass, for example, which does not conduct at any ordinary temperatures, does so at a red heat. Shellac and resin do not insulate so well when they are heated. Water, which is a good conductor, conducts but little in the state of ice at  $0^{\circ}$ , and very badly at  $-25^{\circ}$ . Powdered glass and flour of sulphur conduct very well, while in large masses they are nonconductors; probably because in a state of powder each particle becomes covered with a film of moisture that acts as a conductor. The nonconducting power of glass depends also on its chemical composition.

According to Said Effendi, if the conducting power of water be taken at 1,000, the conducting power of petroleum is 72; alcohol 49; ether 40; turpentine 23; and benzole 16.

**707. Insulating bodies. Common reservoir.**—Bad conductors are called *insulators*, for they are used as supports for bodies in which electricity is to be retained. A conductor remains electrified only so long as it is surrounded by insulators. If this were not the case, as soon as the electrified body came in contact with the earth, which is a good conductor, the electricity would pass into the earth and diffuse itself through its whole extent. On this account, the earth has been named the *common reservoir*. A body is insulated, by being placed on a support with glass feet, or on a resinous cake, or by being suspended by silk threads. No bodies, however, insulate perfectly; all electrified bodies lose their electricity more or less rapidly by means of the supports on which they rest. Glass is always somewhat hygroscopic, and the aqueous vapour which condenses on it affords a passage for the electricity; the insulating power of glass is materially improved by coating it with shellac or copal varnish. Dry air is a *good* insulator, but when the air contains moisture it conducts electricity, and this is the principal source of the loss of electricity. Hence it is necessary in electrical experiments, to rub the supports with cloths dried at the fire, and to surround electrified bodies by glass vessels, containing substances which attract moisture, such as chloride of calcium, or pumice soaked with sulphuric acid.

It is from their great conductivity that metals do not become electrified by friction. But if they are insulated, and then rubbed, they give good indications. This may be seen by the following experiment (fig. 563). A brass



Fig. 563.

tube is provided with a glass handle, by which it is held, and then rubbed with silk or flannel. On approaching the metal to an electrical pendulum (fig. 561), the pith ball will be attracted. If the metal is held in the hand electricity is indeed produced by friction—but it immediately passes through the body into the ground.

If, too, the cap of a gold-leaf electroscope be briskly flapped with a dry silk handkerchief, the gold leaves will diverge.

**708. Distinction of the two kinds of electricity.**—If electricity be developed on a glass rod by friction with silk, and the rod be brought near an electrical pendulum, the ball will be attracted to the glass, and after momentary contact will be again repelled. By this contact the ball becomes electrified, and so long as the two bodies retain their electricity, repulsion follows when they are brought near each other. If a stick of sealing-wax electrified by friction with flannel or silk be approached to another electrical pendulum, the same effects will be produced, the ball will fly towards the wax, and after contact will be repelled. Two bodies, which have been charged with electricity, repel one another. But the electricities, respectively developed in the preceding cases, are not the same. If, after the pith ball had been touched with an electrified glass rod, an electrified stick of sealing-wax, and then an electrified glass rod, be alternately approached to it, the pith ball will be *attracted* by the former and *repelled* by

the latter. Similarly, if the pendulum be charged by contact with the electrified sealing-wax, it will be *repelled* when this is approached to it, but *attracted* by the approach of the excited glass rod.

On experiments of this nature, Dufay first made the observation that there are two different electricities: the one developed by the friction of glass, the other by the friction of resin or shellac. To the first the name *vitreous* electricity is given; to the second the name *resinous* electricity.

**709. Theories of electricity.**—Two theories have been proposed to account for the different effects of electricity. Franklin supposed that there exists a peculiar, subtle, imponderable fluid, which acts by repulsion on its own particles, and pervades all matter. This fluid is present in every substance in a quantity peculiar to it, and when it contains this quantity it is in the natural state, or in a state of equilibrium. By friction certain bodies acquire an additional quantity of the fluid, and are said to be *positively* electrified; others by friction lose a portion and are said to be *negatively* electrified. The former state corresponds to *vitreous* electricity, and the latter to *resinous* electricity. Positive electricity is represented by the sign +, and negative electricity by the sign -; a designation based on the algebraical principle, that when a plus quantity is added to an equal minus quantity zero is produced. So when a body containing a quantity of positive electricity is touched with a body possessing an equivalent quantity of negative electricity, a neutral or zero state is produced.

The *theory of Symmer* assumes that every substance contains an indefinite quantity of a subtle imponderable matter, which is called the electric fluid. This fluid is formed by the union of two fluids—the *positive* and the *negative*. When they are combined they neutralise one another, and the body is then in the natural or neutral state. By friction, and by several other means, the two fluids may be separated, but one of them can never be excited without a simultaneous production of the other. There may, however, be a greater or less excess of the one or the other in any body, and it is then said to be electrified *positively* or *negatively*. As in Franklin's theory, *vitreous* corresponds to *positive* and *resinous* to *negative* electricity. This distinction is merely conventional: it is adopted for the sake of convenience, and there is no other reason why resinous electricity should not be called positive electricity.

Fluids of the same name repel one another, and fluids of opposite kinds attract each other. The fluids can circulate freely on the surface of certain bodies, which are called conductors, but remain confined to certain parts of other, which are called nonconductors.

It must be added that this theory is quite hypothetical; but its general adoption is justified by the convenient explanation which it gives of electrical phenomena.

**710. Action of electrified bodies on each other.**—Admitting the two-fluid hypothesis, the phenomena of attraction and repulsion may be enunciated in the following law, which is the basis of all the theories of frictional electricity.

*Two bodies charged with the same electricity repel each other; two bodies charged with opposite electricities attract each other.*

These attractions and repulsions take place in virtue of the action which

the two electricities exert on themselves, and not in virtue of their action on the particles of matter.

**711. Law of the development of electricity by friction.**—Whenever two bodies are rubbed together, the neutral electricity is decomposed. Two electricities are developed at the same time and in equal quantities—one body takes the positive, and the other the negative electricity. This may be proved by the following simple experiment devised by Faraday:—A small flannel cap provided with a silk thread is fitted on the end of a stout rod of shellac, and rubbed round a few times. When the cap is removed by means of a silk thread, and presented to a pith-ball pendulum charged with positive electricity, the latter will be repelled, proving that the flannel is charged with positive electricity; while if the shellac is presented to the pith ball, it will be attracted, showing that the shellac is charged with negative electricity. Both electricities are present in equal quantities; for if the rod be presented to the electroscope before removing the cap, no action is observed.

The electricity developed on a body by friction depends on the rubber as well as the body rubbed. Thus glass becomes negatively electrified when rubbed with cat's skin, but positively when rubbed with silk. In the following list the substances are arranged in such an order that each becomes positively electrified when rubbed with any of the bodies following, but negatively when rubbed with any of those which precede it:—

- |                  |                   |
|------------------|-------------------|
| 1. Cat's skin.   | 9. Wood.          |
| 2. Flannel.      | 10. Metals.       |
| 3. Ivory.        | 11. Caoutchouc.   |
| 4. Rock crystal. | 12. Sealing-wax.  |
| 5. Glass.        | 13. Resin.        |
| 6. Cotton.       | 14. Sulphur.      |
| 7. Silk.         | 15. Gutta percha. |
| 8. The hand.     | 16. Gun-cotton.   |

The nature of the electricity set free by friction depends also on the degree of polish, the direction of the friction, and the temperature. If two glass discs of different degrees of polish are rubbed against each other, that which is most polished is positively, and that which is least polished is negatively electrified. If two silk ribbons of the same kind are rubbed across each other, that which is transversely rubbed is negatively, and the other positively electrified. If two bodies of the same substance, of the same polish, but of different temperatures, are rubbed together, that which is most heated is negatively electrified. Generally speaking, the particles which are most readily displaced are negatively electrified.

Poggendorff has observed that many substances which have hitherto been regarded as highly negative, such as gun-paper, gun-cotton, and ebonite, yield positive electricity when rubbed with leather coated with amalgam.

**712. Development of electricity by pressure and cleavage.**—Electrical excitement may be produced by other causes than friction. If a disc of wood, covered with oiled silk, and a metal disc, each provided with an insulating handle, be pressed together, and then suddenly separated, the metal disc is negatively electrified. A crystal of Iceland spar pressed be-

tween the fingers becomes positively electrified, and retains this state for some time. The same property is observed in several other minerals, even though conductors, provided they be insulated. If cork and caoutchouc be pressed together, the first becomes positively, and the other negatively electrified. A disc of wood pressed on an orange and separated carries away a good charge of electricity if the contact be rapidly interrupted. But if the disc is slowly removed the quantity is smaller, for the two fluids recombine at the moment of their separation. For this reason there is no apparent effect when the two bodies pressed together are good conductors.

Cleavage also is a source of electricity. If a plate of mica be rapidly split in the dark, a slight phosphorescent light is perceived. Becquerel fixed glass handles to each side of a plate of mica, and then rapidly separated them. On presenting each of the plates thus separated to an electroscope, he found that one was negatively and the other positively electrified. If a stick of sealing-wax be broken the ends exhibit different electricities.

All badly conducting crystalline substances exhibit electrical indications by cleavage. The separated plates are always in opposite electrical conditions, provided they are not good conductors: for if they were, the separation would not be sufficiently rapid to prevent the recombination of the two electricities. To the phenomena here described is due the luminous appearance seen in the dark when sugar is broken.

713. **Pyroelectricity.**—Certain minerals, when warmed, acquire electrical properties; a phenomenon to which the name *pyroelectricity* is given. It is best studied in *tourmaline*, in which it was first discovered from the fact that this mineral has the power of first attracting and then repelling hot ashes when placed among them.

To observe this phenomenon, a crystal of tourmaline is suspended horizontally by a silk thread, in a glass cylinder placed on a heated metal plate. On subsequently investigating the electric condition of the ends by approaching to them successively an electrified glass rod, one end will be found to be positively electrified, and the other end negatively electrified, and each end shows this polarity as long as the temperature rises. The arrangement of the electricity is thus like that of the magnetism in a magnet. The points at which the intensity of free electricity is greatest are called the *poles*, and the line connecting them is the *electric axis*. When a tourmaline, while thus electrified, is broken in the middle, each of the pieces has its two poles.

These polar properties depend on the *change* of temperature. When a tourmaline which has become electrical by being warmed is allowed to cool regularly, it first loses electricity, and then its polarity becomes reversed; that is, the end which was positive now becomes negative, and that which was negative becomes positive, and the position of the poles now remains unchanged so long as the temperature sinks. Tourmaline only becomes pyroelectric within certain limits of temperature; these vary somewhat with the length, but are usually between  $10^{\circ}$  and  $150^{\circ}$  C. Below and above these temperatures it behaves like any other body, and shows no polarity.

The name *analogous* pole is given to that end of the crystal which shows positive electricity when the temperature is rising, and negative electricity

when it is sinking; *antilogous* pole to that end which becomes negative by being heated, and positive by being cooled.

The phenomena of pyroelectricity are intimately connected with the crystalline form of the mineral; and are only seen in those crystals whose forms are *hemihedral*, or which are differently modified at the ends of their crystallographical principal axis.

Besides tourmaline the following minerals are found to be pyroelectric: boracite, topaz, prehnite, silicate of zinc, scolezite, axenite. And the following organic bodies are pyroelectric: cane-sugar, Pasteur's salt (racemate of sodium and ammonium), tartrate of potassium, &c.

## CHAPTER II.

### QUANTITATIVE LAWS OF ELECTRICAL ACTION.

714. **Laws of electrical attractions and repulsions.**—The laws which regulate the attractions and repulsions of electrified bodies may be thus stated:—

I. *The repulsions or attractions between two electrified bodies are in the inverse ratio of the squares of their distance.*

II. *The distance remaining the same, the force of attraction or repulsion between two electrified bodies is directly as the product of the quantities of electricity with which they are charged.*

These laws were established by Coulomb, by means of the torsion balance, used in determining the laws of magnetic attractions and repulsions (686), modified in accordance with the requirements of the case. The wire, on the torsion of which the method depends, is so fine that a foot weighs only  $\frac{1}{10}$  of a grain. At its lower extremity there is a fine shellac thread,  $n$  (fig. 564), at one end of which is a small disc of copper foil,  $n$ . Instead of the vertical magnetic needle, there is a glass rod,  $i$ , terminated by a gilt pith ball,  $m$ , which passes through the aperture  $r$ . The scale  $oc$  is fixed round the sides of the vessel, and during the experiment the ball  $m$  is opposite the zero point  $o$ . The micrometer consists of a small graduated disc,  $e$ , movable independently of the tube,  $d$ , and of a fixed index,  $a$ , which shows by how many degrees the disc is turned. In the centre of the disc there is a small button  $t$ , to which is fixed the wire which supports  $np$ .

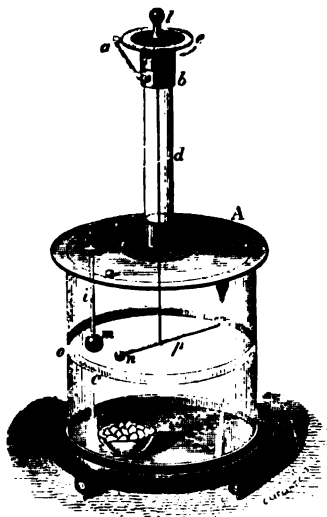

Fig. 564.

i. The micrometer is turned until the zero point is opposite the index,

and the tube  $d$  is turned until the knob  $n$  is opposite zero of the graduated circle : the knob  $m$  is in the same position, and thus presses against  $n$ . The knob  $m$  is then removed and electrified, and replaced in the apparatus, through the aperture  $r$ . As soon as the electrified knob  $m$  touches  $n$ , the latter becomes electrified, and is repelled, and after a few oscillations remains constant at a distance at which the force of repulsion is equal to the force of torsion. In a special experiment Coulomb found the angle of torsion between the two to be  $36^\circ$ ; and as the force of torsion is proportional to the angle of torsion, this angle represents the repulsive force between  $m$  and  $n$ . In order to reduce the angle to  $18^\circ$  it was necessary to turn the disc through  $126^\circ$ . The wire was twisted  $126^\circ$  in the direction of the arrow at its upper extremity, and  $18^\circ$  in the opposite direction at its lower extremity, and hence there was a total torsion of  $144^\circ$ . On turning the micrometer in the same direction, until the angle of deviation was  $8\frac{1}{2}^\circ$ ,  $567^\circ$  of torsion were necessary. Hence the whole torsion was  $575\frac{1}{2}$ . Without sensible error these angles of deviation may be taken at  $36^\circ$ ,  $18^\circ$ , and  $9^\circ$ , and on comparing them with the corresponding angles of torsion  $36^\circ$ ,  $144^\circ$ , and  $576^\circ$ , we see that while the first are as

$$1 : \frac{1}{2} : \frac{1}{4},$$

the latter are as

$$1 : 4 : 16;$$

that is, that for a distance  $\frac{1}{2}$  as great, the angle of torsion is 4 times as great, and that for a distance  $\frac{1}{4}$  as great the repulsive force is 16 times as great.

In experimenting with this apparatus, the air must be thoroughly dry, in order to diminish, as far as possible, loss of electricity. This is effected by placing in it a small dish containing chloride of calcium.

The experiments by which the law of attraction is proved are made in much the same manner, but the two balls are charged with opposite electricities. A certain quantity of electricity is imparted to the movable ball, by means of an insulated pin, and the micrometer moved until there is a certain angle below. A charge of electricity of the opposite kind is then imparted to the fixed ball. The two balls tend to move together, but are prevented by the torsion of the wire, and the movable ball remains at a distance at which there is equilibrium between the force of attraction, which draws the balls together, and that of torsion which tends to separate them. The micrometer screw is then turned to a greater extent, by which more torsion and a greater angle between the two balls are produced. And it is from the relation which exists between the angle of deflection on the one hand, and the angle which expresses the force of torsion on the other, that the law of attraction has been deduced.

ii. To prove this second law let a charge be imparted to  $m$ ;  $n$  being in contact with it becomes charged and is repelled to a certain distance. The angle of deflection being noted, let the ball  $m$  be touched by an insulated but unelectric ball of exactly the same size and kind; in this way half its charge is removed, and the angle of deflection will now be found to be only half its original amount. In like manner if either  $m$  or the movable body be now again deprived of half its electricity, the deflection will be a quarter of what it originally was, and so on.

The two laws are included in the formula  $F = \frac{ee'}{d^2}$  where  $F$  is the force;  $e$  and  $e'$  the quantities of electricity on any two surfaces, and  $d$  the distance between them. If  $e$  and  $e'$  are of opposite electricities the action is one of attraction, while if they are the same it is a repulsive action.

On the *centimetre-gramme-second* system the unit quantity of electricity is that amount which, acting, at a distance of one centimetre across air, on a quantity of electricity equal to itself, would repel it with a force equal to one dyne (691).

**715. Distribution of electricity.**—When an insulated sphere of conducting material is charged with electricity, the electricity passes to the surface of the sphere, and forms an extremely thin layer. If, in Coulomb's balance, the fixed ball be replaced by another electrified sphere, a certain repulsion will be observed. If then this sphere be touched with an insulated sphere identical with the first, but in the neutral state, the first ball will be found to have lost half its electricity, and only half the repulsion will be observed. By repeating this experiment with spheres of various substances, solid and hollow, but all having the same superficies, the result will be the same, excepting that, with imperfectly conducting materials, the time required for the distribution will be greater. From this it is concluded that the distribution of electricity depends on the extent of the surface, and not on the mass, and, therefore, that electricity does not penetrate into the interior, but is confined to the surface. This conclusion is further established by the following experiments:—

i. A thin hollow copper sphere provided with an aperture of about an inch in diameter (fig. 565), and placed on an insulating support, is charged in the interior with electricity. When the *carrier* or *proof plane* (a small disc of copper foil at the end of a slender glass or shellac rod) is applied to the interior, and is then brought near an electroscope, no electrical indications are produced. But if the proof plane is applied to the electroscope after having been in contact with the exterior, a considerable divergence ensues.

The action of the proof plane as a measure of the quantity of electricity is as follows: When it touches any surface the proof plane becomes confounded with the element touched; it takes in some sense its place relatively to the electricity, or rather, it becomes itself the element on which the electricity is diffused. Thus when the proof plane is removed from contact we have in effect cut away from the surface an element of the same thickness and the same extent as its own, and have transferred it to the balance without its losing any of the electricity which covered it.

ii. A hollow globe, fixed on an insulating support, is provided with two hemispherical envelopes which fit closely, and can be separated by glass handles. The interior is now electrified, and the two hemispheres brought

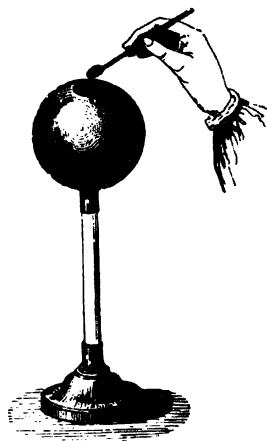

Fig. 565.



in contact. On then rapidly removing them (fig. 566), the coverings will be found to be electrified, while the sphere is in its natural condition.

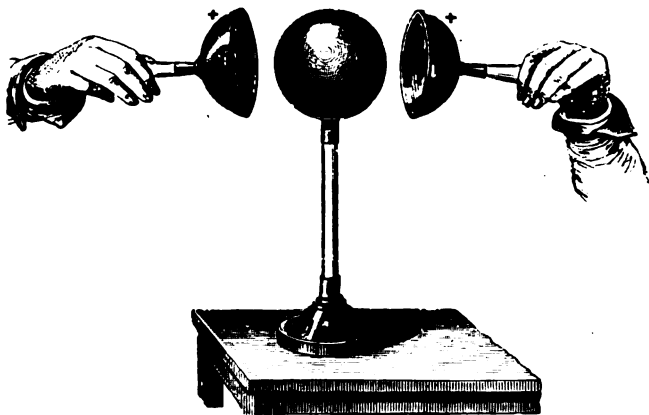

Fig. 566.

iii. The distribution of electricity on the surface may also be shown by means of the following apparatus. It consists of a metallic cylinder on in-



Fig. 567.

insulated supports, on which is fixed a long strip of tin foil which can be rolled up by means of a small insulating handle (fig. 567). A quadrant electro-

meter is fitted in metallic communication with the cylinder. When the sphere is rolled up, a charge is imparted to the cylinder, by which a certain divergence is produced. On unrolling the tinfoil, this divergence gradually diminishes, and increases as it is again rolled up. The quantity of electricity remaining the same, the electrical force, on each unit of surface, is therefore less as the surface is greater.

iv. The following ingenious experiment by Faraday further illustrates this law :—A metal ring is fitted on an insulated support, and a conical gauze bag, such as is used for catching butterflies, is fitted to it (fig. 568).

By means of a silk-thread, the bag can be drawn inside out. After electrifying the bag, it is seen by means of a proof plane that the electricity is on the exterior, but if the positions are reversed by drawing the bag inside out, so that the interior has now become the exterior, the electricity will still be found on the exterior.

v. The same point may be further illustrated by an experiment due to Terquem. A bird-cage, preferably of metal wire, is suspended by insulators, and contains either a gold-leaf electroscope or pieces of Dutch metal, feathers, pith balls, etc. When the cage is connected with an electrical machine, the articles in the interior are quite unaffected, although strong sparks may be taken from the outside. Bands of paper may be fixed to the inside ; while those fixed to the outside diverge widely. A bird in the inside is quite unaffected by the charge or discharge of the electricity of the cage.

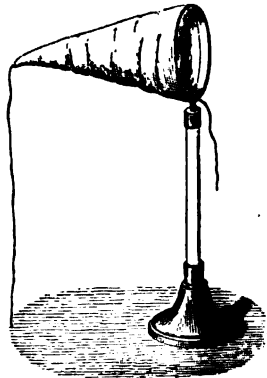

Fig. 568.

The property of electricity, of accumulating on the outside of bodies, is ascribed to the repulsion which the particles exert on each other. Admitting the hypothesis of two fluids, and that opposite electricities attract each other in the inverse ratio of their distances, while like electricities repel one another according to the same law, Poisson, by the aid of mathematical analysis, has arrived at the same conclusion in reference to the distribution of electricity on bodies as that which follows from the previous experiments. Electricity tends constantly to pass to the surface of bodies, where it exists in very thin layers ; it continually tends to escape, but is prevented by the resistance of the feebly conducting atmosphere.

To the statement that electricity resides on the surface of bodies, two exceptions may be noted. When two opposite electricities are discharged through a wire, a phenomenon which when continuous forms an electrical current, the discharge is effected throughout the whole mass of the conductor. Also a body placed inside another may, if insulated from it, receive charges of electricity. On this depends the possibility of electrical experiments in ordinary rooms.

716. **Electric density.**—On a metallic sphere the distribution of the electricity will be uniform in every part, simply from its symmetry. This has been demonstrated by means of the proof plane and the torsion balance.

A metallic sphere placed on an insulating support was electrified, and touched at different parts of its surface with the proof plane, which each time was applied to the movable needle of the torsion balance. As in all cases the torsion observed was sensibly the same, it was concluded that the proof plane had each time received the same quantity of electricity. In the case of an elongated ellipsoid (fig. 569) it is found that the distribution of elec-

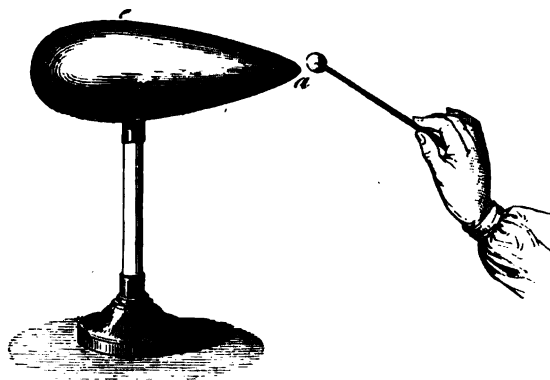

Fig. 569.

tricity is different at different points of the surface. The electricity accumulates at the most acute points. This is demonstrated by successively touching the ellipsoid at different parts with the proof plane, and then bringing this into the torsion balance. By this means Coulomb found that the greatest deflection was produced when the proof plane had been in contact with the point *a*, and the least by contact with the middle space *e*.

The *electric density* or *electric thickness* is the term used to express the quantity of electricity found at any moment on a given surface. If *s* represents the surface and *Q* the quantity of electricity on that surface, then assuming that the electricity is equally distributed, its electrical density is equal to  $\frac{Q}{s}$ .

Coulomb found, by quantitative experiments, that in an ellipsoid the density of the electricity at the equator of the ellipsoid is to that at the ends in the same ratio as the length of the minor to the major axis. On an insulated cylinder, terminated by two hemispheres, the density of the electrical layer at the ends is greater than in the middle. In one case, the ratio of the two densities was found to be as 2:3 : 1. On a circular disc the density is greatest at the edges.

The terms *electric density* and *electrical tension* are often confounded. The latter ought rather to be restricted, as Maxwell proposes, to express the state of strain or pressure exerted upon a dielectric in the neighbourhood of an electrified body; a strain which if continually increased tends to disruptive discharge. Electric tension may thus be compared to the strain on a rope which supports a weight, and the dielectric medium which can support a

certain tension and no more is said to have a certain strength, in the same sense as a rope which bears a certain weight without breaking is said to have a certain strength.

717. **Power of points.**—On a sphere, the electric density is everywhere uniform; the further a body is removed from the shape of a sphere, the more irregular is its accumulation. A pointed rod may be regarded as an elongated ellipsoid, and hence, at its extremity, the electric density will be greatest. But the greater the density, the greater will be the tendency of electricity to overcome the resistance of the air, and escape. If the hand be brought near a point on an electrified conductor a slight wind is felt; and if the disengagement of electricity takes place in the dark a luminous brush is seen. If an electrified conductor is to retain its electricity all sharp points and edges must be avoided; on the other hand, to facilitate the outflow of electricity in apparatus, and experiments, frequent use is made of this property of points.

718. **Communication and distribution of electricity on bodies in contact.**—If two conducting bodies, one electrified and the other in the natural state, be brought into contact, the electricity will be equally distributed over the two: the one will lose and the other gain a quantity of electricity proportional to its surface. If the bodies are not conductors, there will only be loss and gain at the points in contact.

By means of the proof plane and the torsion balance, Coulomb made numerous determinations of the distribution of electricity on bodies in contact. When two insulated metal spheres were placed in contact and electrified, he found that the electricity was unequally distributed, and that in proportion to their diameters. The diameters being equal, the electrical density was zero at the point of contact, and only became sensible at  $23^\circ$  from this point; it increased rapidly from  $20^\circ$  to  $30^\circ$ , then more slowly from  $60^\circ$  to  $90^\circ$ , and was almost constant between  $90^\circ$  and  $180^\circ$ .

When the diameters were unequal, and in the ratio of 2 : 1, the density of the point of contact was still zero, but at first increased most rapidly on the large sphere: it then increased more rapidly on the small one, and at  $180^\circ$  from the point of contact its density was greatest on the small one.

719. **Loss of electricity.**—Experience shows that electrified bodies gradually lose their electricity, even when placed on insulating supports. This loss is due to two causes: firstly, to the imperfection of the insulating supports, and, secondly, to the conductivity of the air.

i. All substances conduct electricity in some degree; those which are termed insulators are simply very bad conductors. An electrified conductor resting on supports must, therefore, lose a certain quantity of its electricity.

ii. The loss by the atmosphere varies with the electric density, with the rapidity with which the air is renewed, and with the hygrometric state.

Dry air is a very imperfect conductor, but when it contains aqueous vapour, it conducts pretty well, and the more moisture it contains the better it conducts. Coulomb has attempted to show 'that in a still atmosphere, and with a constant hygrometric state, the loss for a very short space of time is directly proportional to the tension': a law analogous to Newton's law of cooling (404).

Coulomb experimented with moist air. In perfectly dry gases, Matteucci did not find the loss of electricity in accordance with Coulomb's law. He found that within certain limits, the loss was independent of the quantity of electricity, and proportional to the time; in other words that in equal times there was an equal loss of electricity.

He further found that for equal temperatures and pressures the loss is the same in air, carbonic acid, and hydrogen, provided they are perfectly dry: at a high tension the loss of negative electricity is greater than that of positive; in dry gases, under a constant pressure, the loss increases with the temperature; and lastly, that in dry gases the loss is independent of the nature of the electrified body; that is, it is the same whether it is a conductor or not. Warburg has found that the loss in hydrogen is greater than in carbonic acid or air.

Coulomb found not only that supports never insulate completely, but that they are the cause of an abundant loss of electricity in bodies strongly electrified. The loss diminishes gradually; it is constant when the tension is low, and may be neglected by giving to the supports an adequate length. Brown shellac or ebonite is the best insulator; glass is a hygroscopic substance, and must be dried with great care. It is best covered with a thin layer of shellac varnish, as has already been stated.

720. **Loss of electricity in vacuo.**—Inasmuch as electricity is retained on the surface of bodies by the pressure of the insulating atmosphere, when the pressure diminishes, the loss of electricity increases, and in an ordinary vacuum all electricity escapes. This is a necessary consequence of the mathematical theory of electricity (693), which accounts for the equilibrium of electricity on the surface of bodies. But in opposition to this, Hawksbee, Gray, Snow, Harris, and Becquerel have observed, that feeble electrical charges may be retained in vacuo. Becquerel showed that in a vacuum of a millimetre a body retained a feeble charge for fifteen days, and considers it is probable, that if an electrified body were in a perfect vacuum, it would retain an electrical charge, provided it were sufficiently removed from any body which could exert upon it an inductive action (721). Gassiot has proved that in a vacuum produced by chemical means, which is the most perfect attainable, an electrical charge does not pass; and at present it is considered that a ponderable medium is necessary for the propagation of electricity.

---

## CHAPTER III.

### ACTION OF ELECTRIFIED BODIES ON BODIES IN THE NATURAL STATE. INDUCED ELECTRICITY. ELECTRICAL MACHINES.

721. **Electricity by influence or induction.**—An insulated conductor charged with either kind of electricity, acts on bodies in a natural state placed near it in a manner analogous to that of the action of a magnet on soft iron, that is, it decomposes the neutral fluid, attracting the opposite,

and repelling the like kind of electricity. The action thus exerted is said to take place by *influence* or *induction*.

The phenomena of induction may be demonstrated by means of a brass cylinder placed on an insulating support, and provided at its extremities with two small electric pendulums, which consist of pith balls suspended by linen threads (fig. 570). If this apparatus is placed near an insulated con-

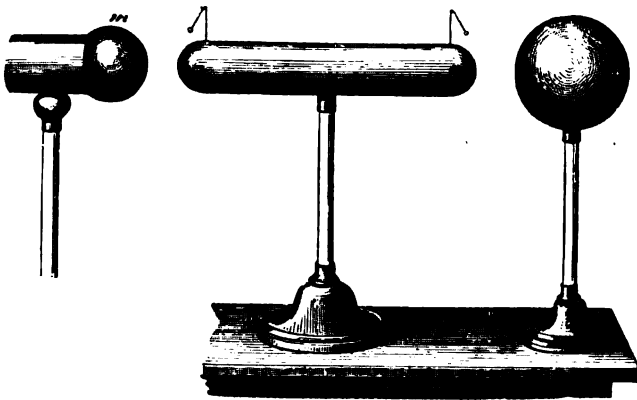

Fig. 570.

ductor *m*, charged with either kind of electricity—for instance, the conductor of an electrical machine, which is charged with positive electricity—the natural electricity of the cylinder is decomposed, free electricity will be developed at each end, and both pendulums will diverge. If, while they still diverge, a stick of sealing-wax, excited by friction with flannel, be approached to that end of the cylinder nearest the conductor, the corresponding pith ball will be repelled, indicating that it is charged with the same kind of electricity as the sealing-wax, that is, with negative electricity; while if the excited sealing-wax is brought near the other ball it will be attracted, showing that it is charged with positive electricity. If, further, a glass rod, excited by friction with silk, and therefore charged with positive electricity, be approached to the end nearest the conductor, the pendulum will be attracted; while if brought near the other end, the corresponding pendulum will be repelled. If the influence of the charged conductor be suppressed, either by removing it, or placing it in communication with the ground, the separated electricities will recombine, and the pendulums exhibit no divergence.

The cause of this phenomenon is obviously a decomposition of the neutral electricity of the cylinder, by the free positive electricity of the conductor; the opposite or negative electricity being attracted to that end of the cylinder nearest the conductor, while the similar electricity is repelled to the other end. Between these two extremities, there is a space destitute of free electricity. This is seen by arranging on the cylinders a series of pairs of pith balls suspended by threads. The divergence is greatest at each extremity, and there is a line at which there is no divergence at all, which is

called the *neutral line*. The two fluids, although equal in quantity, are not distributed over the cylinder in a symmetrical manner ; the attraction which accumulates the negative electricity at the one end is, in consequence of the greater nearness, greater than the repulsion which drives the positive electricity to the other end, and hence the neutral line is nearer one end than the other. Nor is the electricity induced at the two ends of the cylinder under the same conditions. That which is repelled to the distant extremity is free to escape if a communication be made with the ground, whilst on the other hand, the unlike electricity which is attracted is held bound or captive by the inducing action of the electrified body. Even if contact be made with the ground on the face of the cylinder adjacent to the inducing body, the electricity induced on that face will not escape. The repelled electricity, however, on the distant surface is not thus bound ; it is free to escape by any conducting channel, and hence will immediately disappear wherever contact be made between the ground and the cylinder. Both the pith balls will collapse, and all signs of electricity on the cylinder depart with the escape of the repelled or free electricity. But now, if communication with the ground be broken and the inducing body be discharged or removed to a considerable distance, the attracted or bound electricity is itself set free, and diffusing over the whole cylinder causes the pith balls again to diverge, but now with the opposite electricity to that of the original inducing body. The reason for the escape of the repelled electricity is as follows :—If the cylinder be placed in connection with the ground, by metallic contact with the posterior extremity, and the charged conductor be still placed near the anterior extremity, the conductor will exert its inductive action as before. But it is now no longer the conductor alone which is influenced. It is a conductor consisting of the conductor itself, the metallic wire, and the whole earth. The neutral line will recede indefinitely, and since the conductor has become infinite, the quantity of neutral fluid decomposed will be increased. Hence, when the posterior extremity is placed in contact with the ground, the pendulum at the anterior extremity diverges more widely. If the connecting rod be now removed, neither the quantity nor the distribution will be altered ; and if the conductor be removed, or be discharged, a charge of negative electricity will be left on the cylinder. It will, in fact, remain charged with electricity, the opposite of that of the charged conductor. Even if, instead of connecting the posterior extremity of the cylinder with the ground, any other part had been so connected, the general result would have been the same. All the parts of the cylinder would be charged with negative electricity, and, on interrupting the communication with the earth, would remain so charged.

Thus a body can be charged with electricity by induction as well as by conduction. But, in the latter case, the charging body loses part of its electricity, which remains unchanged in the former case. The electricity imparted by conduction is of the same kind as that of the electrified body, while that excited by induction is of the opposite kind. To impart electricity by conduction, the body must be quite insulated, while in the case of induction it must be in connection with the earth, at all events momentarily.

A body electrified by induction acts in turn on bodies placed near it, separating the two fluids in a manner shown by the signs on the sphere.

What has here been said has referred to the inductive action exerted on good conductors. Bad conductors are not so easily acted upon by induction, owing to the great resistance they present to the circulation of electricity, but, when once charged, the electric state is more permanent.

This is analogous to what is met with in magnetism; a magnet instantaneously evokes magnetism in a piece of soft iron, but this is only temporary, and depends on the continued action of the magnet; a magnet magnetises steel with far greater difficulty, but this magnetism is permanent.

The fundamental phenomena of induction may be conveniently investigated and demonstrated by means of the apparatus represented in figure 571, which consists of a narrow cylindrical brass tube BA supported by an insulating glass handle and held over the excited cake of an electrophorus (729).

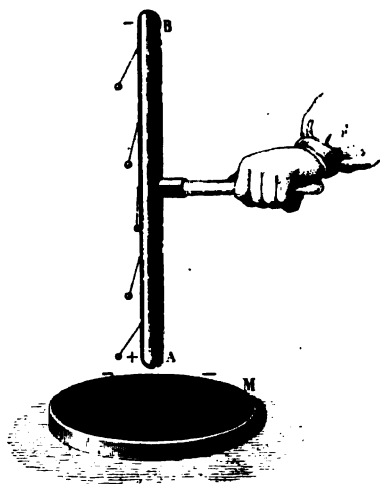

Fig. 571.

722. **Faraday's experiments.**—The following experiments of Faraday are excellent illustrations of the operation of induction.

A carefully insulated metal cylinder, A, fig. 572, is connected by a wire with an electroscope E, at some distance. On placing inside the cylinder an insulated brass ball C, charged with positive electricity, the leaves of the electroscope diverge with positive electricity, and the divergence increases until a certain depth is attained, when there is no further increase. The divergence now remains constant, whatever be the position of the ball, even when it touches the cylinder. On withdrawing the ball it is found to be perfectly discharged. Hence the charge on the surface is equal to that which the ball had originally.

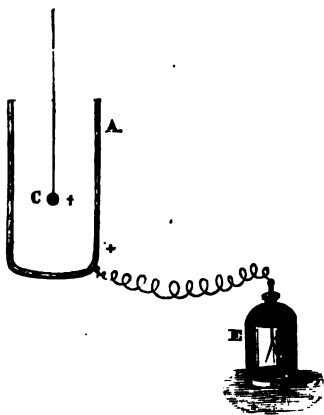

Fig. 572.

Four such cylinders, fig. 573, are placed concentrically within each other, and are insulated from each other by discs of shellac, and the outer one is connected with the electroscope. On introducing the charged ball into the central cavity the leaves diverge just as if the intermediate ones did not exist. Each of these is charged with equal quantities of opposite electricities, all equal in value to that of the sphere. The internal charge



of the cylinder is the same as if all the intermediate cylinders were superposed, and the charge does not vary even when the intermediate ones are connected with each other or are touched by the electrified ball C.

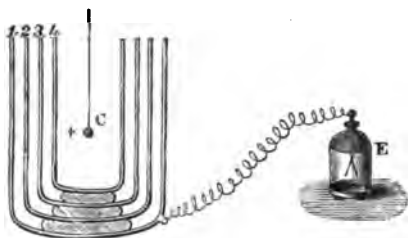

Fig. 573.

If, while C is in its original condition, the internal cylinder, 4, is connected with the ground, the leaves collapse, and the other cylinders are in the neutral state; the two layers which remain, positive on C, and

negative on the adjacent cylinder, are without action on an external point. If any other cylinder be thus treated the external ones are reduced to the neutral state.

**723. Limit to the action of induction.**—The inductive action which an electrified body exerts on an adjacent body in decomposing its neutral fluid is limited. On the surface of the insulated cylinder, which we have considered in the preceding paragraph, let there be at  $n$  any small quantity of neutral electricity (fig. 574). The positive electricity of the source  $m$  first

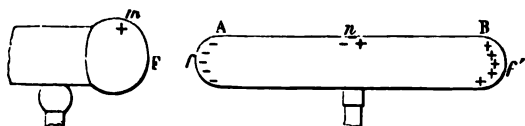

Fig. 574.

decomposes by induction the neutral electricity in  $n$ , attracting its negative towards A, and repelling positive towards B; but in the degree in which the extremity A becomes charged with negative electricity, and the extremity B with positive electricity, there are developed at A and B two forces  $f$  and  $f'$  which act in the opposite direction to the original force. For the forces  $f$  and  $f'$  concur in driving towards B the negative fluid of  $n$ , and towards A its positive fluid. But as the inducing force  $F$  which is exerted at  $m$  is constant, while the forces  $f$  and  $f'$  are increasing, a time arrives at which the force  $F$  is balanced by the forces  $f$  and  $f'$ . All decomposition of the neutral fluid then ceases; the inducing action has attained its limit.

If the cylinder be removed from the source of electricity, as the inducing action decreases, a portion of the free liquids at A and at B recombine to form the neutral fluid. If, on the other hand, they are brought nearer, as the force  $F$  now exceeds the forces  $f$  and  $f'$ , a new decomposition of the neutral fluid takes place, and fresh quantities of positive and negative fluids are respectively accumulated at A and B.

**724. Faraday's theory of induction.**—Hitherto, the influence of the medium, which separates the electrified from the unelectrified body, in the case of induction, has been neglected. But Faraday's researches prove that it is in this medium that the inductive actions take place; and that the in-

ductive action is not an action at a distance, or rather at no distance greater than that between any two molecules. Faraday supposes that, in this medium, successions of layers become alternately positively and negatively electrified. This condition is called *dielectric polarisation*.

The following experiment was devised by Faraday to illustrate this *polarisation of the medium*, as he has called it. He placed small filaments of silk in a vessel of turpentine, and having plunged two conductors in the liquid in opposite sides, he charged one and placed the other in connection with the ground. The particles of silk immediately arranged themselves end to end, and adhered closely together, forming a continuous chain between the two sides. An experiment by Matteucci also supports Faraday's theory. He placed several thin plates of mica closely together, and provided the outside ones with metallic coatings, like a fulminating pane (747). Having electrified the system, the coatings were removed by insulating handles, and on examining the plates of mica successively, each was found charged with positive electricity on one side, and negative electricity on the other.

On the new view, the action exerted by electrified bodies on bodies in the neutral state, is effected by the polarisation of the alternate layers of air or any other medium. On the old view, the air was supposed to be quite passive, or at most, in virtue of its nonconductivity, to oppose a resistance to the recombination of the two fluids.

725. **Specific inductive capacity.**—Faraday names the property which bodies possess of transmitting the electric influence, the *inductive power*.



Fig. 575.

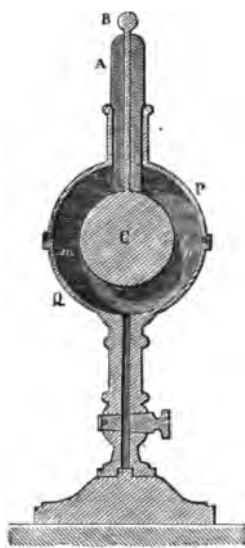

Fig. 576.

All insulating bodies do not possess it in the same degree. To determine and compare the inductive power Faraday used the apparatus represented

in fig. 575, and of which fig. 576 represents a vertical section. It consists of a brass sphere made up of two halves, P and Q, which fit accurately into each other, like the Magdeburg hemispheres. In the interior of this spherical envelope, there is a smaller brass sphere, C, connected with a metal rod, terminating in a ball, B. The rod is insulated from the envelope PQ, by a thick layer of shellac, A. The space *mn* receives the substance whose inductive power is to be determined. The foot of the apparatus is provided with a screw and stopcock, so that it can be screwed on the air pump, and the air in *mn* either rarefied or exhausted.

Two such apparatus perfectly identical are used, and at first they only contain air. The envelopes PQ are connected with the ground, and the knob B of one of them receives a charge of electricity. The sphere C thus becomes charged like the inner coating of a Leyden jar (748). The layer *mn* represents the insulator which separates the two coatings. By touching B with the proof plane, which is then applied to the torsion balance, the quantity of free electricity is measured. In one experiment Faraday observed a torsion of  $250^\circ$ , which represented the free electricity on B. The knob B was then placed in metallic connection with the knob B' of the other apparatus, and the torsion was now found to be  $125^\circ$ , showing that the electricity had become equally distributed on the two spheres, as might have been anticipated, since the pieces of apparatus were quite equal and each contained air in the space *mn*.

This experiment having been made, the space *mn* in the second apparatus was filled with the substance whose inductive power was to be determined; for example, shellac. The other apparatus, in which *mn* is filled with air, having been charged, the density of the free electricity on C was measured. Let it be taken at  $290^\circ$ , the number observed by Faraday, in a special case. When the knob B of the first apparatus was connected with the knob B' of the second, the density was not found to be  $145^\circ$ , as would be expected. The apparatus containing air exhibited a density of  $114^\circ$ , and that with shellac of  $113^\circ$ . Hence the former had lost  $176^\circ$ , and had retained  $114^\circ$ , while the latter ought to have exhibited a density of  $176^\circ$  instead of  $113^\circ$ . The second apparatus had taken more than half the charge, and hence a larger quantity of electricity had been dissipated by the shellac. Of the total quantity of electricity, the shellac had taken  $176^\circ$ , and the air  $114^\circ$ ; hence the specific inductive capacity of air is to that of shellac as  $114 : 176$ , or as  $1 : 1.55$ . That is, the inductive power of shellac is more than half as great again as air.

By various methods, the following numbers have been obtained for the specific inductive capacity of *dielectrics*, as they are called in opposition to *anelectrics* or conductors:—

Air . . . . .	1.00	Sulphur . . . . .	1.93
Spermaceti . . . . .	1.45	Shellac . . . . .	1.95
Resin . . . . .	1.76	Paraffine . . . . .	1.98
Pitch . . . . .	1.80	India-rubber . . . . .	2.80
Bees-wax . . . . .	1.86	Gutta-percha . . . . .	4.00
Glass . . . . .	1.90	Mica . . . . .	5.00

These values are known as the *dielectric constants*.

By the following simple experiment the influence of the dielectric may be shown. At a fixed distance above a gold-leaf electroscope, let an electrified sphere be placed, by which a certain divergence of the leaves is produced. If now, the charges remaining the same, a disc of sulphur or of shellac be interposed, the divergence increases, showing that inductive action takes place through the sulphur, to a greater extent than through a layer of air of the same thickness.

Faraday finds that all gases have the same inductive capacity, and that this is independent of the temperature and pressure.

726. **Communication of electricity at a distance.**—In the experiment represented in figure 571 the opposite electricities of the conductor, and that of the separated cylinder, tend to unite, but are prevented by the resistance of the air. If the density is increased, or, if the distance of the bodies be diminished, the opposed electricities at length overcome this obstacle; they rush together and combine, producing a spark, accompanied by a sharp sound. The negative electricity separated on the cylinder, being thus neutralised by the positive electricity of the charged body, a charge of positive electricity remains on the cylinder. The same phenomenon is observed when a finger is presented to a strongly electrified conductor. The latter decomposes by induction the neutral electricity of the body, the opposite electricities combine with the production of a spark, while the electricity of the same kind as the electrified conductor, which is left on the body, passes off into the ground.

The striking distance varies with the density, the shape of the bodies, their conducting power, and with the resistance and pressure of the interposed medium.

727. **Motion of electrified bodies.**—The various phenomena of attraction and repulsion which are among the most frequent manifestations of electrical action may all be explained by means of the laws of induction. If M (fig. 577) be a fixed insulated conductor charged with positive electricity, and N be a movable insulated body, for instance, an electrical pendulum, there are three cases to be considered:—

i. *The movable body is unelectrified, and is a conductor.* In this case M acting inductively on N, attracts the negative and repels the positive electricity, so that the maxima of density are respectively at the points *a* and *b*. Now *a* is nearer *c* than it is to *b*, and since attractions and repulsions are inversely as the square of the distance, the attraction between *a* and *c* is greater than the repulsion between *b* and *c*, and, therefore, N will be attracted to M by a force equal to the excess of the attractive over the repulsive force.

ii. *The movable body is a conductor, and is electrified.*—If the electricity of the movable body is different from that of the fixed body, there is always attraction, but if they are of the same kind, there is at first repulsion and afterwards attraction. This anomaly may be thus explained: Besides its charge of electricity, the movable body contains neutral fluid. This is decomposed by the induction of the positive fluid on M, and, consequently, the hemisphere *b* obtains an additional supply of positive electricity, while *a* becomes charged with negative electricity. There is thus attraction and

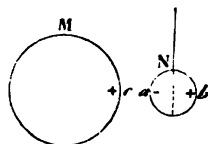

Fig. 577.

repulsion, as in the foregoing case. The force of repulsion is at first greater, because the quantity of positive electricity on N is greater than that of negative; but as the distance *ac* diminishes, the attractive force increases more rapidly than the repulsive force, and finally exceeds it.

iii. *The movable body is a bad conductor.*—If N is charged, repulsion or attraction takes place, according as the electricity is of the same or opposite kind to that of the fixed body. If it is in the natural state, since a powerful and permanent source of electricity can more or less decompose the neutral fluid even of bad conductors, the body M will decompose the neutral fluid of N, and attraction will take place as in the first case.

728. **Gold-leaf electroscope.**—The name *electroscope* is given to instruments for detecting the presence, and determining the kind, of electricity in any body. The original pith-ball pendulum is an electroscope; but, though sometimes convenient, it is not sufficiently delicate. Many successive improvements have been made in it, and have resulted in the form now generally used, which is due to Bennett.

*Bennett's, or the gold-leaf electroscope.*—This consists of a tubulated glass shade B (fig. 578), standing on a metal foot, which thus communicates with the ground. A metal rod terminating at its upper extremity in a knob C, and holding at its lower end two narrow strips of gold-leaf *n n*, fits into the tubulure of the shade, the neck of which is coated with an insulating varnish. The air in the interior is dried by quicklime, or by chloride of calcium, and on the insides of the shade there are two strips of gold-leaf *a*, communicating with the ground.



Fig. 578.

When the knob is touched with a body charged with either kind of electricity, the leaves diverge; usually however the apparatus is charged by induction thus:—

If an electrified body, a stick of sealing-wax, for example, be brought near the knob, it will decompose the natural electricity of the system, attracting to the knob the electricity of the opposite kind, and retaining it there, and repelling the electricity of the same kind to the gold leaves, which consequently diverge. In this way the presence of an electrical charge is ascertained but not its quality.

To ascertain the *kind* of electricity the following method is pursued:—If, while the instrument is under the influence of the body A, which we will suppose has a negative charge, the knob be touched by the finger, the negative electricity decomposed by induction passes off into the ground, and the previously divergent leaves will collapse; there only remains positive electricity, retained in the knob by induction from A. If now the finger be first removed, and then the electrified body, the positive electricity previously retained by A will spread over the system, and cause the leaves to

diverge. If now, while the system is charged with positive electricity, a positively electrified body, as, for example, an excited glass rod, be approached, the leaves will diverge more widely; for the electricity of the same kind will be repelled to the extremities. If, on the contrary, an excited shellac rod be presented, the leaves will tend to collapse, the electricity with which they are charged, being attracted by the opposite electricity. Hence we may ascertain the kind of electricity, either by imparting to the electroscope electricity from the body under examination, and then bringing near it a rod charged with positive or negative electricity; or the electroscope may be charged with a known kind of electricity, and the electrified body in question brought near the electroscope.

It has been proposed to use the gold-leaf electroscope as an *electrometer* or measurer of electricity, by measuring the angle of divergence of the leaves; this is done by placing behind them a graduated scale; for small angles the quantity of electricity is nearly proportional to the sine of half the angle of divergence. There are, however, objections to such a use, and the electroscope is rarely employed for this purpose.

#### ELECTRICAL MACHINES.

729. **Electrophorus.**—It will now be convenient to describe the various electrical machines, or apparatus for generating and collecting large supplies of static electricity. One of the most simple and inexpensive of these is



Fig. 579.

Fig. 580.

the *electrophorus*, which was invented by Volta. Its operation, like that of all other electric machines, depends on the action of induction, of which it forms an excellent illustration. It consists of a *cake* of resin, B (fig. 580), say about 12 inches diameter, and an inch thick, which is placed on a metallic surface, or frequently fits in a wooden mould lined with tinfoil, which is

called the *form*. Besides this there is a metal disc, A (fig. 580), of a diameter somewhat less than that of the cake, and provided with an insulating glass handle ; this is the *cover*. The mode of working is as follows : All the parts of the apparatus having been well warmed, the cake, which is placed in the form, or rests on a metal surface, is briskly flapped with silk, or, better, with catskin, by which it becomes charged with negative electricity. The cover is then placed on the cake. Owing, however, to the minute rugosities of the surface of the resin, the cover only comes in contact with a few points, and, from the non-conductivity of the resin, the negative electricity of the cake does not pass off to the cover. On the contrary, it acts by induction on the neutral electricity of the cover, and decomposes it, attracting the positive electricity to the under surface, and repelling the negative electricity to the upper. If the upper surface be now touched with the finger, the negative electricity, because repelled and free, passes off, and the cover remains charged with positive electricity, held, however, by the negative electricity of the cake ; the two electricities do not unite, in consequence of the non-conductivity of the cake (fig. 579). If now the cover be raised by its insulating handle, the charge diffuses itself over the surface, and, if a conductor be brought near it, (fig. 580) a smart spark passes.

The metallic form on which the cake rests plays an important part in the action of the electrophorus, as it increases the quantity of electricity, and makes it more permanent. For the negative electricity of the upper surface of the resin, acting inductively on the neutral electricity of the lower, decomposes it, retaining on the under surface the positive electricity, while the negative electricity passes off into the ground. The positive electricity thus developed on the under surface reacts on the negative electricity of the upper surface, binding it, and causing it to penetrate into the badly conducting mass, on the surface of which fresh quantities of electricity can be excited, far beyond the limits possible without the action of the form. It is for this reason that the electrophorus, once charged, retains its state for a considerable time, and sparks can be taken even after a long interval. If the form be insulated, the charge obtained from it is far less than if it is on a conducting support. For the negative electricity developed by induction on the lower surface being now unable to escape, the condensing action referred to cannot take place, and only a feeble charge can be given to the resin. The retention of electricity is greatly promoted by keeping the cake on the form, and placing the cover upon it, by which the access of air is hindered. Instead of a cake of resin, a disc of gutta percha, or vulcanised cloth, or vulcanite, may be substituted ; and, of course, if glass, or any material which becomes positively electrified by friction, be used, the cover acquires a negative charge.

The electrophorus is a good instance of the conversion of work into electro-potential energy (64). When the cover is lifted from the excited cake work must be expended in order to overcome the attraction of the electricity in the cake, for the opposite electricity developed by induction on the cover ; and the equivalent of this work appears in the form of the electricity thus detached. Thus, when a Leyden jar is charged either by the machine or by the electrophorus, the energy of the charge is a transformation of the work of the operator.

730. **Plate electrical machine.**—The first electrical machine was invented by Otto von Guericke, the inventor also of the air-pump. It consisted of a sphere of sulphur which was turned on an axis by means of the hand, while the other, pressing against it, served as a rubber. Resin was afterwards substituted for the sulphur, which, in turn, Hawksbec replaced by a glass cylinder. In all these cases the hand served as rubber,

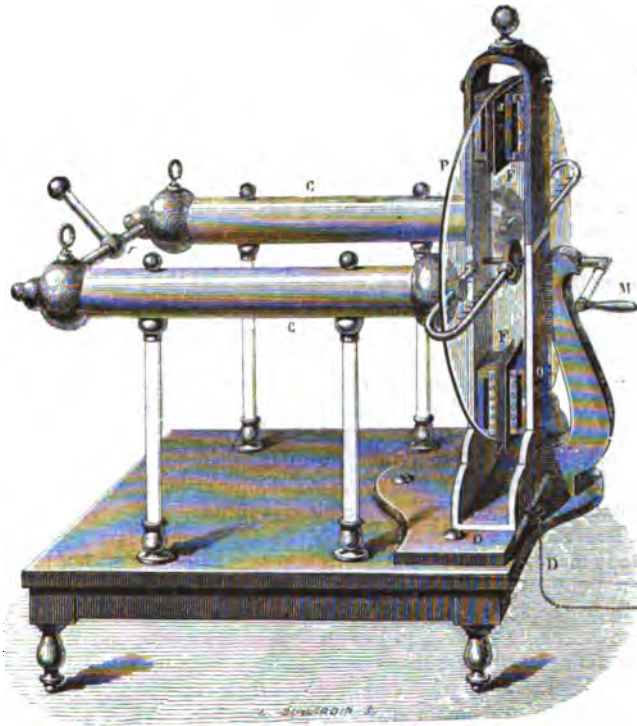

Fig. 581.

and Winckler, in 1740, first introduced cushions of horsehair, covered with silk, as rubbers. At the same time Bose collected electricity, disengaged by friction, on an insulated cylinder of tin plate. Lastly, Ramsden, in 1760, replaced the glass cylinder by a circular glass plate, which was rubbed by cushions. The form which the machine has now is but a modification of Ramsden's original machine.

Between two wooden supports (fig. 581) a circular glass plate, P, is suspended by an axis passing through the centre, and which is turned by means of a handle, M. The plate revolves between two sets of *cushions* or *rubbers*, F, of leather or of silk, one set above the axis and one below, which, by means of screws, can be pressed as tightly against the glass as may be desired. The plate also passes between two brass rods shaped like



a horse-shoe, and provided with a series of points on the sides opposite the glass; these rods are fixed to larger metallic cylinders, C, which are called the prime *conductors*. The latter are insulated by being supported on glass feet, and are connected with each other by a smaller rod  $r_2$ .

The action of the machine is founded on the excitation of electricity by friction, and on the action of induction. By friction with the rubbers, the glass becomes positively and the rubbers negatively electrified. If now the rubbers were insulated, they would receive a certain charge of negative electricity which it would be impossible to exceed, for the tendency of the opposed electricities to reunite would be equal to the power of the friction to decompose the neutral fluid. But the rubbers communicate with the ground by means of a chain, and, consequently, as fast as the negative electricity is generated, its tension is reduced to zero by contact with the ground. The positive electricity of the glass acts then by induction on the conductor, attracting the negative electricity. This negative electricity collects on the points opposite to the glass. Here its tendency to discharge becomes so high that it passes across the intervening space of air, and neutralises the positive electricity on the glass. The conductors thus lose their negative electricity, and remain charged with positive electricity. The plate accordingly gives up nothing to the prime conductors; in fact, it only abstracts from them their negative electricity.

If the hand be brought near the conductor when charged, a spark follows, which is renewed as the machine is turned. In this case the positive electricity decomposes the neutral electricity of the body, attracting its negative electricity, and combining with it when the two have a sufficient tension. Thus with each spark, the conductor reverts to the neutral state, but becomes again electrified as the plate is turned.

**731. Precautions in reference to the machine.**—The glass, of which the plate is made, must be as little hygroscopic as possible. Of late ebonite has been frequently substituted for glass; it has the advantage of being neither hygroscopic nor fragile, and of readily becoming electrical by friction. The plate is usually from  $\frac{1}{12}$  to  $\frac{1}{8}$  of an inch in thickness, and from 20 to 30 inches in diameter, though these dimensions are not unfrequently exceeded.

The rubbers require great care, both in their construction and their preservation. They are commonly made of leather, stuffed with horsehair. Before use they are coated either with powdered *aurum musivum* (sulphuret of tin), or graphite, or amalgam. The action of these substances is not very clearly understood. Some consider that it merely consists in promoting friction. Others, again, believe that a chemical action is produced, and assign, in support of this view, the peculiar smell noticed near the rubbers when the machine is worked. Amalgams, perhaps, promote most powerfully the disengagement of electricity. *Kienmayer's amalgam* is the best of them. It is prepared as follows: one part of zinc and one part of tin are melted together, and removed from the fire and two parts of mercury stirred in. The mass is transferred to a wooden box containing some chalk, and then well shaken. The amalgam, before it is quite cold, is powdered in an iron mortar, and preserved in a stoppered glass vessel. For use a little cacao butter or lard is spread over the cushion, some of the powdered amalgam sprinkled over it, and the surface smoothed by a ball of flattened leather.

In order to avoid a loss of electricity, two quadrant-shaped pieces of oiled silk are fixed to the rubbers, so as to cover the plate on both sides, one at the upper part from *a* to *F*, and the other in the corresponding part of the lower rubbers. These flaps are not represented in the figure. Yellow oiled silk is the best, and there must be perfect contact between the plate and the cloth.

Ramsden's machine, as represented in fig. 581, only gives positive electricity. But it may be arranged so as to give negative electricity by placing it on a table with insulating supports. By means of a chain the conductor is connected with the ground, and the machine worked as before. The positive electricity passes off by the chain into the ground, while the negative electricity remains on the supports and on the insulated table. On bringing the finger near the uprights, a sharper spark than the ordinary one is obtained.

732. **Maximum of charge.**—It is impossible to exceed a certain limit of electrical charge with the machine, whatever precautions are taken, or however rapidly the plate is turned. This limit is attained when the loss of electricity equals its production. The loss depends on three causes: i. The loss by the atmosphere, and the moisture it contains; this is proportional to the density. ii. The loss by the supports. iii. The recombination of the electricities of the rubbers and the glass.

The first two causes have been already mentioned. With reference to the latter, it must be noticed that the electrical tension increases with the rapidity of the rotation, until it reaches a point at which it overcomes the resistance presented by the non-conductivity of the glass. At this point, a portion of the two electricities separated on the rubbers and on the glass recombines, and the tension remains constant. It is, therefore, ultimately independent of the rapidity of rotation.

733. **Quadrant electrometer.**—The electrical charge is measured by the *quadrant* or *Henley's electrometer*, which is attached to the conductor. This is a small electric pendulum, consisting of a wooden rod, *d*, to which is attached an ivory or cardboard scale (fig. 582). In the centre of this is a small whalebone index, movable on an axis, and terminating in a pith ball. Being attached to the conductor, the index diverges as the machine is charged, ceasing to rise when the limit is attained. When the rotation is discontinued the index falls rapidly if the air is moist, but in dry air it only falls slowly, showing, therefore, that the loss of electricity in the latter case is less than in the former.

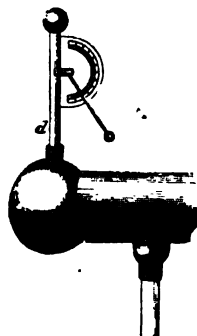

Fig. 582.

734. **Cylinder electrical machine.**—The construction of the cylinder machines, as ordinarily used in England, is due to Nairne. They are well adapted for obtaining either kind of electricity. In Nairne's machine (fig. 583) the cylinder is rubbed by only one cushion, *C*, which is made of leather stuffed with horsehair, and is screwed to an insulated conductor, *A*. On the opposite side of the cylinder there is a similar insulated conductor *B*, provided with a series of points on the sides next the glass.

To the lower part of the cushion C is attached a piece of oiled silk, which extends over the cylinder to just above the points. This is not represented in the figure. When the cylinder is turned, A becomes charged with negative and B with positive electricity by the loss of its negative from the points

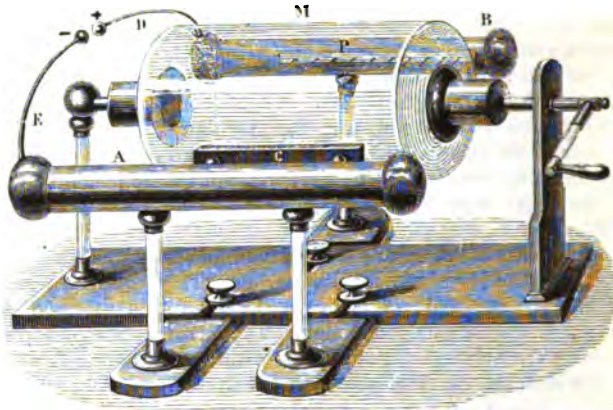

Fig. 583.

P. The two opposite electricities will now unite by a succession of sparks across D and E. If use is to be made of the electricity, either the rubber or the prime conductor must be connected with the ground. In the former case positive electricity is obtained, in the latter negative.

735. **Armstrong's hydro-electric machine.**—In this machine electricity is produced by the disengagement of aqueous vapour through narrow orifices. The discovery of the machine was occasioned by an accident. A workman having accidentally held one hand in a jet of steam, which was issuing from an orifice in a steam boiler at high pressure, while his other hand grasped the safety valve, was astonished at experiencing a smart shock. Sir W. Armstrong (then Mr. Armstrong, of Newcastle), whose attention was drawn to this phenomenon, ascertained that the vapour was charged with positive electricity, and by repeating the experiment with an insulated locomotive, he found that the boiler was negatively charged. Armstrong believed that the electricity was due to a sudden expansion of the vapour; Faraday, who afterwards examined the question, ascertained its true cause, which will be best understood after describing a machine which Armstrong devised for reproducing the phenomenon.

It consists of a boiler of wrought-iron plate (fig. 584), with a central fire, and insulated on four legs. It is about 5 feet long by 2 feet in diameter, and is provided at the side with a gauge, O, to show the height of the water in the boiler. C is the stopcock, which is opened when the vapour has sufficient pressure. Above this is the box, B, in which are the tubes through which the vapour is disengaged. On these are fitted jets of a peculiar construction, which will be understood from the section of one of them, M, represented on a larger scale. They are lined with hard wood in a manner represented by

the diagram. The box B contains cold water. Thus, the vapour, before escaping, undergoes partial condensation, and becomes charged with vesicles of water; a necessary condition, for Faraday found that no electricity is produced when the vapour is perfectly dry.

The development of electricity in the machine was at first attributed to the condensation of the vapour, but Faraday found that it is solely due to

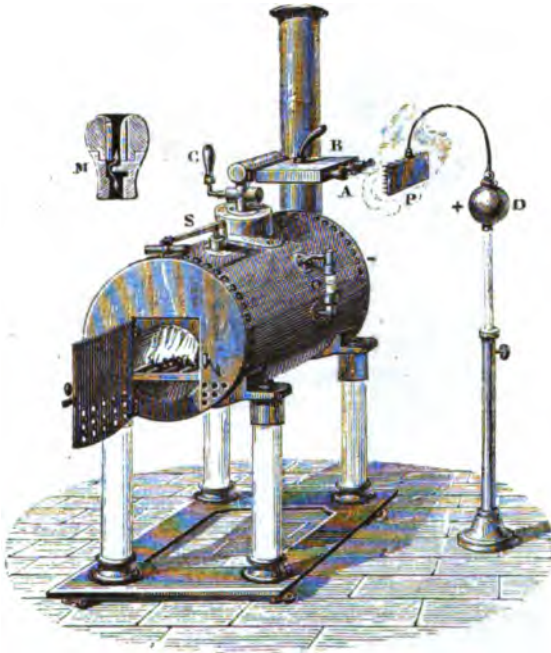

Fig. 584.

the friction of the globules of water against the jet. For if the little cylinders which line the jets are changed, the kind of electricity is changed; and if ivory is substituted, little or no electricity is produced. The same effect is produced if any fatty matter is introduced into the boiler. In this case the linings are of no use. It is only in case the water is pure that electricity is disengaged, and the addition of acid or saline solutions, even in minute quantity, prevents any disengagement of electricity. If turpentine is added to the boiler, the effect is reversed—the vapour becomes negatively, and the boiler positively, electrified.

With a current of moist air Faraday obtained effects similar to those of this apparatus, but with dry air no effect is produced.

**736. Holtz's electrical machine.**—Before the end of last century electrical machines were known in this country in which the electricity was not developed by friction, but by the continuous inductive action of a body already electrified, as the electrophorus; within the last few years such machines

have been re-invented and come into use. The form represented in fig. 585 was invented by Holtz, of Berlin.

It consists of two circular plates of thin glass at a distance of 3 mm. from each other; the larger one, AA, which is 2 feet in diameter, is fixed by means of 4 wooden rollers *a*, resting on glass axes and glass feet. The diameter of the second plate, BB, is 2 inches less; it turns on a horizontal glass axis, which passes through a hole in the centre of the large fixed plate without touching it. In the plate A, on the same diameter, are two large apertures

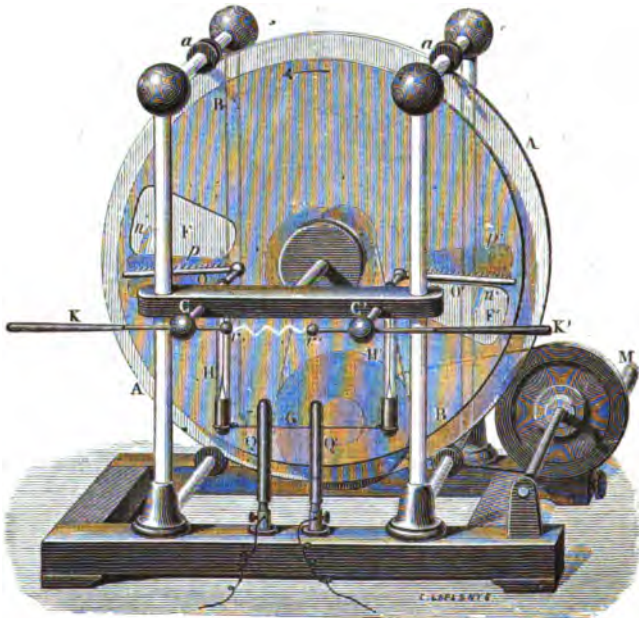

Fig. 585.

or windows, FF'. Along the lower edge of the window F, on the posterior face of the plate, a band of paper, *p*, is glued, and on the anterior face a sort of tongue of thin cardboard, *n*, joined to *p* by a thin strip of paper, and projecting into the window. At the upper edge of the window, F', there are corresponding parts, *p'* and *n'*. The papers *p* and *p'* constitute the armatures. The two plates, the armatures, and their tongues are carefully covered with shellac varnish, but more especially the edges of the tongues.

In front of the plate B, at the height of the armatures, are two brass combs, O O', supported by two conductors of the same metal, C C'. In the front end of these conductors are two pretty large brass knobs, through which pass two brass rods terminated by smaller knobs, *r r'*, and provided with wooden handles, KK'. These rods, besides moving with gentle friction in the knobs, can also be turned so as to be more or less inclined towards

each other. The plate is turned by means of a winch, M, and a series of pulleys which transmit its motion to the axis; the velocity which it thus receives is 12 to 15 turns in a second, and the rotation should take place in the direction indicated by the arrow—that is, towards the points of the cardboard tongues  $nn'$ .

To work the machine, the armatures  $p p'$  must be first *primed*; that is, one of the armatures is positively and the other negatively electrified. This is effected by means of a plate of ebonite, which is excited by striking it with flannel, or, better, with catskin; the two knobs  $r r'$  having been connected, the electrified ebonite is brought near one of them,  $p$ , for instance, and the plate B is turned. The ebonite is charged with negative electricity, which, acting inductively on the armature  $p$ , decomposes its neutral fluid, and the negative electricity repelled is discharged by the tongue  $u$ , on to the movable plate, the armature remaining charged with positive electricity. After half a turn the negative electricity of the plate coming in front of the window  $F'$  acts in the same way on the armature  $p'$ , charging it with negative electricity by taking from it a corresponding quantity of positive electricity by the tongue  $u'$ . After a few turns the two armatures being thus electrified, one positively and the other negatively, the inducing plate of ebonite is removed, and the knobs  $r r'$  separated, as represented in the figure. On continuing to turn the plate an uninterrupted torrent of sparks strikes across from one knob to the other.

These details being known, the following explanation of the action of the machine is given by Riess.

When a conductor is under the influence of an electrified body, it becomes charged with opposite electricities on its two opposite surfaces (721). This is also the case with nonconductors, with the difference, that the separation of the two electricities, which is instantaneous in the first case, takes place slowly in the second. But if, between the source of electricity and a good conductor, a bad conductor, such as a plate of glass, be interposed, the inductive action is modified. Supposing the source of electricity to be positive, if its action be prolonged, the good and the bad conductors are negatively electrified on the side turned towards the source, and positively on the opposite side.

If the inductive action is of short duration, the influence is weak, and the electricity, with which the glass plate is charged on its posterior face is negative electricity, imparted by the good conductor, especially if it is provided with points. The plate B is thus electrified negatively on the two faces; a phenomenon which Riess calls *double influence*.

That being granted, let fig. 586 represent a horizontal projection of the details of fig. 585, the letters having in both cases the same meaning. The two armatures  $p$  and  $p'$ , having been electrified, as we have seen, one positively and the other negatively, when two opposite faces  $m$  and  $m'$ , of a portion of the plate B pass in front of the window F, then from what has been said above, the faces  $m$  and  $m'$ , in the presence of the positive armature  $p$ , both become negatively electrified; the conductor Cr, having imparted its negative electricity to the face  $m'$  of the plate B, remains positively electrified. Then, the rotation continuing, the elements  $m$  and  $m'$  both come in front of the windows  $F'$  negatively charged. There the element  $m'$ , adding its

influence to that of the negative armature  $p'$ , withdraws from the conductor  $C'r'$  its positive electricity, thus charging it with negative electricity. The element  $m$ , acting inductively on the armature  $p'$ , withdraws positive fluid from it by induction, and thus tends to keep it in the negative state. The

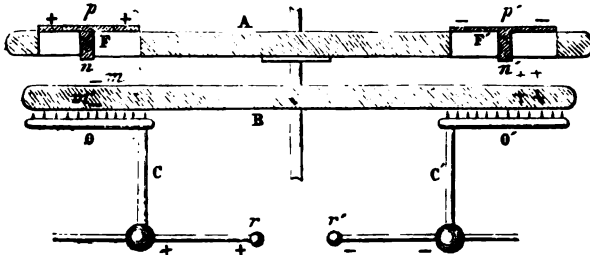

Fig. 586.

two elements  $m$  and  $m'$  thus revert to the neutral state, and passing in front of the window  $F$ , the same series of phenomena is reproduced.

In Holtz's machine electricity is used in three forms, which double influence can develop. The *free* electricity of conductors is used in experiments. The electricity induced upon the external face of the movable disc, and the electricity *communicated* to the inner face are removed by the disc, and serve to keep up the charge of the armatures. The line of the combs divides this disc in two halves, which are every minute electrified in opposite directions. Each of them is of the same kind as the conductor or armature towards which it is moving, and of opposite sign to the comb towards which the rotation carries it. The nature of the electricity is observed from the shape of the brush which escapes from it; the brushes are long and diverging on the positive comb; short and like luminous points on the negative comb.

With plates of equal dimensions Holtz's machine is far more powerful than the ordinary electrical machine (730). The power is still further increased by suspending to the conductors  $CC'$  two *condensers*,  $HH'$  (743), which consist of two glass tubes coated with tinfoil, inside and out, to within a fifth of their height. Each of them is closed by a cork, through which passes a rod, communicating at one end with the inner coating, and suspended to one of the conductors by a crook at the other end. The two external coatings are connected by a conductor,  $G$ . They are, in fact, only two small Leyden jars (748), one of them,  $H$ , becoming charged with positive electricity on the inside, and negative on the outside; the other,  $H'$ , with negative electricity on the inside, and positive on the outside. Becoming charged by the play of the machine, and being discharged at the same rate by the knobs  $r r'$ , they strengthen the spark, which may attain a length of 6 or 7 inches.

The current of the machine is utilised by placing in front of the frame two brass uprights,  $QQ'$ , with binding screws in which are copper wires; then, by means of the handles  $KK'$ , the rods which support the knobs  $r r'$  are inclined, so that they are in contact with the uprights. The current being then directed by the wires, a battery of six jars can be charged in a few

minutes, water can be decomposed, a galvanometer deflected, and Geissler's tubes illuminated as with the voltaic battery.

Kohlrausch found that a Holtz's machine with a plate 46 inches in diameter, and making 5 turns in three seconds, produced a constant current capable of decomposing water at the rate of  $3\frac{1}{2}$  millionths of a milligramme in a second. This is equal to the effect produced by a Grove's cell in a current of 45,000 BA units.

Rossetti, who made a series of measurements with a Holtz's machine, found that the strength of the current (801) is nearly proportional to the velocity of the rotation; it increases a little more rapidly than the rotation. The ratio of the velocity of rotation to the strength of the current is greater when the hygrometric state increases. The current produced by a Holtz's machine is quite comparable to that of a voltaic couple. Its electro-motive force and resistance (913) are constant, provided the velocity of rotation and hygrometric state are constant.

The electro-motive force is independent of the velocity of rotation; but diminishes as the moisture increases; it is nearly 52,000 times as great as that of a Daniell's cell.

The internal resistance is independent of the moisture, but diminishes rapidly with increased velocity of rotation. Thus with a velocity of 120 turns in a minute it is represented by 2,810 millions of BA units, and with a velocity of 450 turns it is 646 such units.

737. **Bertsch's machine.**—This is a simpler, though at the same time less powerful, apparatus than Holtz's machine, with which it has otherwise much similarity.

It consists of an ebonite plate,  $PP'$ , about 18 inches in diameter, and mounted on a glass axis (fig. 587). The inducing plate  $E$ , represented separately at the top of the figure as  $E'$ , is also of ebonite, and is placed in a groove at the base of the machine, near the plate  $PP'$ , but not in contact with it. The inducing plate  $E$  having been electrified, with negative electricity suppose, acts through the plate  $P$  on the comb  $n$ , withdrawing from it positive electricity which passes to the plate, and repels negative to the conductor  $bc$ . The plate  $P$ , continuing to turn, arrives charged with positive electricity in front of the second comb  $m$ . Here it withdraws from the comb  $m$ , and from the conductor  $a$ , negative electricity, which restores it to the neutral state, while the conductor  $ad$  remains positively charged. As the rotation of the plate is continued, the conductors  $a$  and  $b$  continue to become charged with opposite electricities, and if the knobs are at a distance of 3 to 4 inches, an uninterrupted succession of sparks passes between them.

The intensity of the sparks increases when the conductor  $b$  is connected with the ground by means of a chain  $R$ . It is further increased by interposing a condenser,  $\Sigma$ , between the conductors  $a$  and  $b$ . This consists of two glass tubes cemented together at the bottoms. At each end is a curved wire connected with the internal lining, which is of tinfoil. A single sheet of tinfoil coats the outside, so that they are no more than two small Leyden jars connected by their outside coatings. They become charged with contrary electricities from the conductors  $a$  and  $b$ , and being discharged at the same time as them, increase the spark.



a horse-shoe, and provided with a series of points on the sides opposite the glass; these rods are fixed to larger metallic cylinders, C, which are called the prime *conductors*. The latter are insulated by being supported on glass feet, and are connected with each other by a smaller rod  $r_4$ .

The action of the machine is founded on the excitation of electricity by friction, and on the action of induction. By friction with the rubbers, the glass becomes positively and the rubbers negatively electrified. If now the rubbers were insulated, they would receive a certain charge of negative electricity which it would be impossible to exceed, for the tendency of the opposed electricities to reunite would be equal to the power of the friction to decompose the neutral fluid. But the rubbers communicate with the ground by means of a chain, and, consequently, as fast as the negative electricity is generated, its tension is reduced to zero by contact with the ground. The positive electricity of the glass acts then by induction on the conductor, attracting the negative electricity. This negative electricity collects on the points opposite to the glass. Here its tendency to discharge becomes so high that it passes across the intervening space of air, and neutralises the positive electricity on the glass. The conductors thus lose their negative electricity, and remain charged with positive electricity. The plate accordingly gives up nothing to the prime conductors; in fact, it only abstracts from them their negative electricity.

If the hand be brought near the conductor when charged, a spark follows, which is renewed as the machine is turned. In this case the positive electricity decomposes the neutral electricity of the body, attracting its negative electricity, and combining with it when the two have a sufficient tension. Thus with each spark, the conductor reverts to the neutral state, but becomes again electrified as the plate is turned.

**731. Precautions in reference to the machine.**—The glass, of which the plate is made, must be as little hygroscopic as possible. Of late ebonite has been frequently substituted for glass; it has the advantage of being neither hygroscopic nor fragile, and of readily becoming electrical by friction. The plate is usually from  $\frac{1}{12}$  to  $\frac{1}{8}$  of an inch in thickness, and from 20 to 30 inches in diameter, though these dimensions are not unfrequently exceeded.

The rubbers require great care, both in their construction and their preservation. They are commonly made of leather, stuffed with horsehair. Before use they are coated either with powdered *aurum musivum* (sulphuret of tin), or graphite, or amalgam. The action of these substances is not very clearly understood. Some consider that it merely consists in promoting friction. Others, again, believe that a chemical action is produced, and assign, in support of this view, the peculiar smell noticed near the rubbers when the machine is worked. Amalgams, perhaps, promote most powerfully the disengagement of electricity. *Kieumayer's amalgam* is the best of them. It is prepared as follows: one part of zinc and one part of tin are melted together, and removed from the fire and two parts of mercury stirred in. The mass is transferred to a wooden box containing some chalk, and then well shaken. The amalgam, before it is quite cold, is powdered in an iron mortar, and preserved in a stoppered glass vessel. For use a little cacao butter or lard is spread over the cushion, some of the powdered amalgam sprinkled over it, and the surface smoothed by a ball of flattened leather.

In order to avoid a loss of electricity, two quadrant-shaped pieces of oiled silk are fixed to the rubbers, so as to cover the plate on both sides, one at the upper part from *a* to *F*, and the other in the corresponding part of the lower rubbers. These flaps are not represented in the figure. Yellow oiled silk is the best, and there must be perfect contact between the plate and the cloth.

Ramsden's machine, as represented in fig. 581, only gives positive electricity. But it may be arranged so as to give negative electricity by placing it on a table with insulating supports. By means of a chain the conductor is connected with the ground, and the machine worked as before. The positive electricity passes off by the chain into the ground, while the negative electricity remains on the supports and on the insulated table. On bringing the finger near the uprights, a sharper spark than the ordinary one is obtained.

**732. Maximum of charge.**—It is impossible to exceed a certain limit of electrical charge with the machine, whatever precautions are taken, or however rapidly the plate is turned. This limit is attained when the loss of electricity equals its production. The loss depends on three causes: i. The loss by the atmosphere, and the moisture it contains; this is proportional to the density. ii. The loss by the supports. iii. The recombination of the electricities of the rubbers and the glass.

The first two causes have been already mentioned. With reference to the latter, it must be noticed that the electrical tension increases with the rapidity of the rotation, until it reaches a point at which it overcomes the resistance presented by the non-conductivity of the glass. At this point, a portion of the two electricities separated on the rubbers and on the glass recombines, and the tension remains constant. It is, therefore, ultimately independent of the rapidity of rotation.

**733. Quadrant electrometer.**—The electrical charge is measured by the *quadrant* or *Henley's electrometer*, which is attached to the conductor. This is a small electric pendulum, consisting of a wooden rod, *d*, to which is attached an ivory or cardboard scale (fig. 582). In the centre of this is a small whalebone index, movable on an axis, and terminating in a pith ball. Being attached to the conductor, the index diverges as the machine is charged, ceasing to rise when the limit is attained. When the rotation is discontinued the index falls rapidly if the air is moist, but in dry air it only falls slowly, showing, therefore, that the loss of electricity in the latter case is less than in the former.

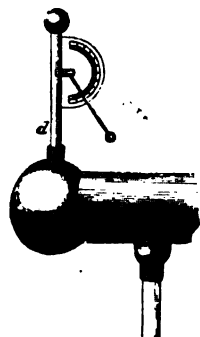

Fig. 582.

**734. Cylinder electrical machine.**—The construction of the cylinder machines, as ordinarily used in England, is due to Nairne. They are well adapted for obtaining either kind of electricity. In Nairne's machine (fig. 583) the cylinder is rubbed by only one cushion, *C*, which is made of leather stuffed with horsehair, and is screwed to an insulated conductor, *A*. On the opposite side of the cylinder there is a similar insulated conductor *B*, provided with a series of points on the sides next the glass.

which is used as support. From the teeth of the sector  $p$  positive electricity flows on the plate B as it moves, and by induction this sector  $p$  yields to the comb  $g$  a surcharge of negative electricity. The rod  $d$  and the knob  $e$  may be withdrawn at will from the conductor C (fig. 588), so that sparks of different lengths may be taken. At  $r$  is a hook to which can be attached the Leyden jars which are to be charged.

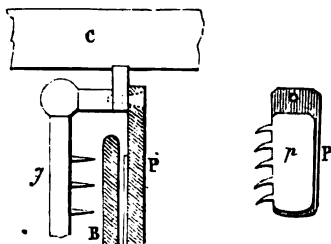

Fig. 589.

Owing to the direct action, and when the inducing plate is as the maximum charge, Carré's machine is not very much affected by moisture, and it yields a large supply of electricity. With plates whose dimensions are respectively 38 and 49 centimetres, it gives sparks of 15 to 18 centimetres, and more when a condenser is added, as in Holtz's and Bertsch's machines.

**739. Work required for the production of electricity.**—In all electrical machines electricity is only produced by the expenditure of a definite amount of force, as will at once be seen by a perusal of the preceding descriptions. The action of these machines, however, which work continuously, is somewhat complex. Not only is electricity produced, but heat also; and it has been hitherto impossible to estimate separately the work required for the heat from that required for the electricity. This is easily done in theory, but not in practice; how difficult, for instance, it would be to determine the temperature of the cushion, or of the plate of a Ramsden's machine.

In lifting the plate off a charged electrophorus, a certain expenditure of force is needed, though it be too slight to be directly estimated (729). With a Holtz's machine it may be readily shown that there is a definite expenditure of force in working it. If such a machine be turned without having been charged, the work required is only that necessary to overcome the passive resistances. If, however, one of the sectors be charged and the electric action comes into play, it will be observed that there must be a distinct increase in the force necessary to work the machine.

From the relation between the quantity of heat produced by the current of a Holtz's machine working under definite conditions, and the amount of work expended in producing the rotation of the plate, Rossetti has made a determination of the mechanical equivalent of heat which gave the number 1,397; agreeing, therefore, very well with the numbers obtained by other methods (483).

#### EXPERIMENTS WITH THE ELECTRICAL MACHINE.

**740. Spark.**—One of the most curious phenomena observed with the electrical machine is the spark drawn from the conductor when a finger is presented to it. The positive electricity of the conductor, acting inductively on the neutral electricity of the body, decomposes it, repelling the positive and attracting the negative. When the attraction of the opposite electricities is sufficiently great to overcome the resistance of the air, they recombine

with a smart crack and a spark. The spark is instantaneous, and is accompanied by a sharp prickly sensation, more especially with a powerful machine. Its shape varies. When it strikes at a short distance, it is rectilinear, as seen in fig. 590. Beyond two or three inches in length, the spark becomes irregular, and has the form of a sinuous curve with branches (fig. 591). If the discharge is very powerful, the spark takes a zig-zag shape (fig. 592). These two latter appearances are seen in the lightning discharge.

A spark may be taken from the human body by the aid of the *insulating stool*, which is simply a low stool with stout glass legs. The person standing

Fig. 590.



Fig. 591.

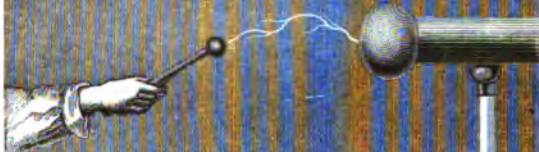
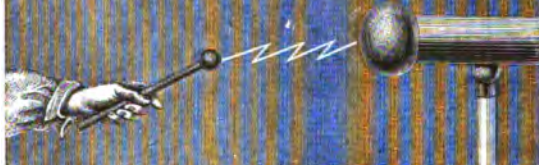

Fig. 592.



on this stool touches the prime conductor, and as the human body is a conductor, the electricity is distributed over its surface as over an ordinary insulated metallic conductor. The hair diverges in consequence of repulsion, a peculiar sensation is felt on the face, and if another person, standing on the ground, presents his hand to any part of the body, a smart crack with a pricking sensation is produced.

A person standing on an insulated stool may be positively electrified by being struck with a catskin. If the person holding the catskin stands on an insulated stool, the striker becomes positively, and the person struck negatively, electrified.

**741. Electrical chimes.**—The *electrical chimes* is a piece of apparatus consisting of three bells suspended to a horizontal metal rod (fig. 593). Two of them, A and B, are in metallic connection with the conductor; the middle bell hangs by a silk thread, and is thus insulated from the conductor, but is connected with the ground by means of a chain. Between the bells are

small copper balls suspended by silk threads. When the machine is worked, the bells A and B, being positively electrified, attract the copper balls, and after contact repel them. Being now positively electrified, they are in turn attracted by the middle bell, C, which is charged with negative electricity by induction from A to B. After contact they are again repelled, and this process is repeated as long as the machine is in action.

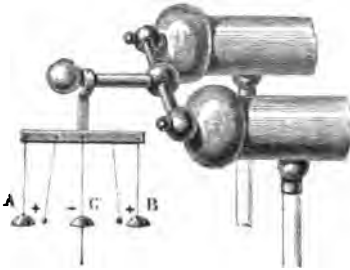

Fig. 593.

Fig. 594 represents an apparatus originally devised by Volta for the purpose of illustrating what he supposed to be the motion of hail between two clouds oppositely electrified. It

consists of a tubulated glass shade, with a metal base, on which are some pith balls. The tubulure has a metal cap, through which passes a brass

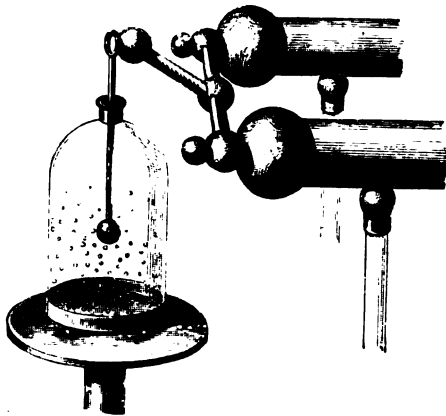

Fig. 594.

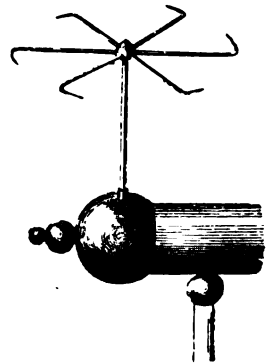

Fig. 595.

rod, provided with a metal disc or sphere at the lower end, and at the upper with a knob, which touches the prime conductor.

When the machine is worked, the sphere becoming positively electrified, attracts the light pith balls, which are then immediately repelled, and, having lost their charge of positive electricity, are again attracted, again repelled, and so on, as long as the machine continues to be worked. An amusing modification of this experiment is frequently made by placing between the two plates small pith figures, somewhat loaded at the base. When the machine is worked, the figures execute a regular dance.

742. **Electrical whirl or vane.**—The electrical *whirl* or *vane* consists of 5 or 6 wires, terminating in points, all bent in the same direction, and fixed in a central cap, which rotates on a pivot (fig. 595). When the apparatus is placed on the conductor, and the machine worked, the whirl begins to

revolve in a direction opposite that of the points. This motion is not analogous to that of the hydraulic tourniquet (213). It is not caused by a flow of material fluid, but is owing to a repulsion between the electricity of the points and that which they impart to the adjacent air by conduction. The electricity being accumulated on the points in a high state of density, passes into the air, and imparting thus a charge of electricity, repels this electricity, while it is itself repelled. That this is the case is evident from the fact that, on approaching the hand to the whirl while in motion, a slight draught is felt, due to the movement of the electrified air, while in vacuo the apparatus does not act at all. This draught or wind is known as the electrical *aura*.

If the experiment be made in water the fly remains stationary, for water is a good conductor; but in olive oil, which is a bad conductor, the whirl rotates.

When the electricity thus escapes by a point, the electrified air is repelled so strongly as not only to be perceptible to the hand, but also to engender a

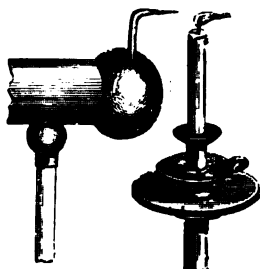

Fig. 596.

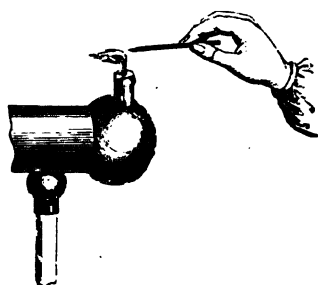

Fig. 597.

current strong enough to blow out a candle. Fig. 596 shows this experiment. The same effect is produced by placing a taper on the conductor, and bringing near it a pointed wire held in the hand (fig. 597). The current arises in this case from the flow of air electrified with the contrary electricity which escapes by the point under the influence of the machine.

The *electrical orrery* and the *electrical inclined plane* are analogous in their action to these pieces of apparatus.

## CHAPTER IV.

### CONDENSATION OF ELECTRICITY.

**743. Condensers. Theory of condensers.**—A *condenser* is an apparatus for condensing a large quantity of electricity on a comparatively small surface. The form may vary considerably, but in all cases consists essentially of two insulated conductors, separated by a nonconductor, and the working depends on the action of induction.

Epinus's condenser consists of two circular brass plates, A and B (fig. 598),

with a sheet of glass, C, between them. The plates, each provided with a pith-ball pendulum, are mounted on insulated glass legs, and can be moved along a support, and fixed in any position. When electricity is to be ac-

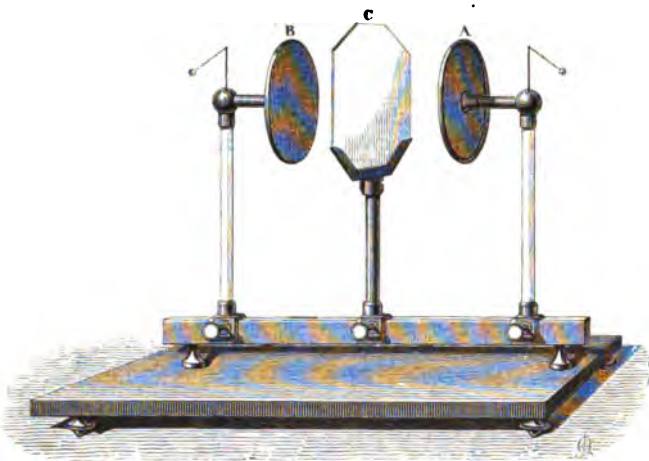

Fig. 598.

cumulated, the plates are placed in contact with the glass, and then one of them, B for instance, is connected with the electrical machine, and the other placed in connection with the ground, as shown in fig. 599.

In explaining the action of the condenser, it will be convenient in each case to call that side of the metal plate nearest the glass the *anterior*, and

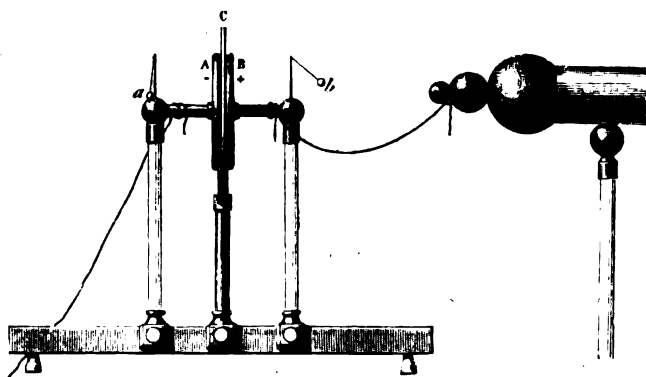

Fig. 599.

the other the *posterior* side. And first let A be at such distance from B as to be out of the sphere of its action. The plate B, which is then connected with the conductor of the electrical machine, takes its maximum charge,

which is distributed equally on its two faces, and the pendulum diverges widely. If the connection with the machine be interrupted, nothing would be changed; but if the plate A be slowly approached, its neutral fluid being decomposed by the influence of B, the negative is accumulated on its anterior face, *n* (fig. 600), and the positive passes into the ground. But as the negative electricity of the plate A reacts in its turn on the positive of the plate B, the latter fluid ceases to be equally distributed on both faces, and is accumulated on its anterior face, *m*. The posterior face, *p*, having thus lost a portion of its electricity, its density has diminished, and is no longer equal to that of the machine, and the pendulum, *b*, diverges less widely. Hence B can receive a fresh quantity from the machine, which, acting as just described, decomposes by induction a second quantity of

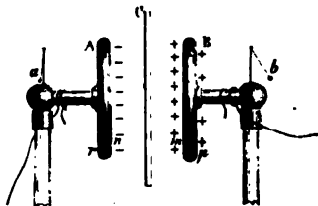

Fig. 600.

neutral fluid on the plate A. There is then a new accumulation of negative fluid on the face *n*, and consequently of positive fluid on *m*. But each time that the machine gives off electricity to the plate, only a part of this passes to the face *m*, the other remaining on the face *p*; the density here, therefore, continues to increase until it equals that of the machine. From this moment equilibrium is established, and a limit to the charge is attained which cannot be exceeded. The quantity of electricity accumulated now on the two faces *m* and *n* is very considerable, and yet the pendulum diverges just as much as it did when A was absent, and no more; in fact, the density at *p* is just what it was then—namely, that of the machine.

When the condenser is charged—that is, when the opposite electricities are accumulated on the anterior faces—connection with the ground is broken by raising the wires. The plate A is charged with negative electricity, but simply on its anterior face (fig. 600), the other side being neutral. The plate B, on the contrary, is electrified on both sides, but unequally; the accumulation is only on its anterior face, while on the posterior, *p*, the density is simply equal to that of the machine at the moment the connections are interrupted. In fact, the pendulum *b* diverges and *a* remains vertical. But if the two plates are removed, the two pendulums diverge (fig. 598), which is owing to the circumstance that, as the plates no longer act on each other, the positive fluid is equally distributed on the two faces of the plate B, and the negative on those of the plate A.

744. **Slow discharge and instantaneous discharge.**—While the plates A and B are in contact with the glass (fig. 599), and the connections interrupted, the condenser may be discharged—that is, restored to the neutral state, in two ways; either by a slow or by an instantaneous discharge. To discharge it slowly, the plate B—that is, the one containing an excess of electricity—is touched with the finger; a spark passes, all the electricity on *p* passes into the ground, the pendulum *b* falls, but *a* diverges. For B having lost part of its electricity, only retains on the face *m* that held by the inductive influence of the negative on A. But the quantity thus retained at B is less than that on A; this has free electricity, which makes the pendulum



*a* diverge, and if it now be touched, a spark passes, the pendulum *a* sinks while *b* rises, and so on by continuing to touch alternately the two plates. The discharge only takes place slowly; in very dry air it may require several hours. If the plate A were touched first, no electricity would be removed, for all it has is retained by that of the plate B. To remove the total quantity of electricity by the method of alternate contacts, an infinite number of such contacts would theoretically be required, as will be seen from the following calculation:—

Let the total quantity of positive electricity on B be taken = 1 : by induction it retains on A a quantity less than its own of negative electricity; let this quantity be called *m*; *m* being a fraction in all cases less than unity, but which varies with the distance of the plates and the nature of the dielectric. Now the *m* of negative electricity on A, reacting in turn on the positive on B, retains there  $m \times m = m^2$  of positive electricity, and therefore the free electricity on B, that which makes the pendulum *b* diverge is  $1 - m^2$ , and if B be touched this quantity is removed. The *m* of negative on A now retains, on B,  $m^2$  of positive; this binds in turn *m* times its own quantity—that is,  $m^3$  of negative on A—and the free negative electricity which now makes the pendulum *a* diverge is represented by  $m - m^3 = m(1 - m^2)$ . If A be now touched, this quantity is removed, the pendulum *a* sinks and *b* rises; for B has now an excess of free electricity, which it is readily seen is presented by  $m^2(1 - m^2)$ . By pursuing this reasoning, it will be seen that the following expresses the quantities removed and left after each successive contact:—

Positive.	I	m	Negative.
$1 - m^2$ ;	$m^2$	$m^3$ ;	$m(1 - m^2)$
$(1 - m^2)m^2$ ;	$m^4$	$m^5$ ;	$m^3(1 - m^2)$
$(1 - m^2)m^4$ ;	$m^6$	$m^7$ ;	$m^5(1 - m^2)$
$(1 - m^2)m^{n+2}$ ;	$m^n$	$m^{n+1}$ ;	$m^{n-1}(1 - m^2)$

An instantaneous discharge may be effected by means of the *discharging rod* (fig. 601). This consists of two bent brass wires, terminating in knobs, and joined by a hinge.

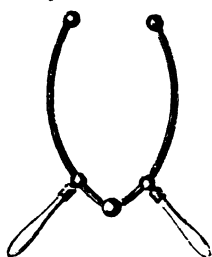

Fig. 601.

When provided with glass handles as in fig. 601, it forms a *glass discharging rod*. In using this apparatus one of the knobs is pressed against one plate of the condenser, and the other knob brought near the other. At a certain distance a spark strikes from the plate to the knob, caused by the sudden recomposition of the two opposite electricities.

When the condenser is charged by the discharger no sensation is experienced, even though the latter be held in the hand; of the two conductors, the electric fluid always chooses the better, and hence the discharge is effected through the metal, and not through the body. But if, while one hand is in contact with one plate, the other touches the second, the discharge takes place through the breast and arms, and a considerable shock is felt; and the larger the

surface of the condenser, and the greater the electric density, the more violent is the shock.

745. **Calculation of the condensing force.**—The condensing force is the relation between the whole charge, which the collecting plate can take while under the influence of the second plate, to that which it would take if alone; in other words, it is the relation of the total quantity of electricity on the collecting plate to that which remains free; for it is assumed that the quantity of free electricity on the collecting plate is the same as that which it would take if it were alone.

To calculate the condensing force, let us, as before, express the total quantity of positive electricity which the collecting plate B can take while under the influence of the condensing plate, by  $I$ , then  $m$  is the whole quantity of negative electricity on the second plate. But, as we have just seen, the quantity of free electricity on B is  $I - m^2$ . Hence  $\frac{I}{I - m^2}$  is the fraction which expresses the condensing force.

The value of  $m$  is determined experimentally by means of the proof plane and the torsion balance. Thus, if  $m$  were 0.99, the quantity of electricity which could be accumulated on the collecting plate B, under the influence of A, would be 50 times as much as the quantity it could receive if alone; while, if  $m$  were 0.75, the quantity would be 2.28 times as great.

746. **Limit of the charge of condensers.**—The quantity of electricity which can be accumulated on each plate is, *ceteris paribus*, proportional to the density of the electricity on the conductor, and to the surface of the plates; it decreases as the insulating plate is thicker, and it differs with the specific inductive capacity of the substance. Two causes limit the quantity of electricity which can be accumulated. First, that the electric density of the collecting plates gradually increases, and ultimately equals that of the machine, which cannot, therefore, impart any free electricity. The second cause is the imperfect resistance which the insulating plate offers to the recombination of the two opposite electricities; for when the force which impels the two fluids to recombine exceeds the resistance offered by the insulating plate, it is perforated and the contrary fluids unite.

747. **Fulminating pane. Franklin's plate.**—This is a simple form of the condenser, and is more suitable for giving strong shocks and sparks. It consists of a glass plate fixed in a wooden frame (fig. 602); on each side of the glass, pieces of tinfoil are fastened opposite each other, leaving a space free between the edge and the frame. It is well to cover this part of the glass with an insulating layer of shellac varnish. One of the sheets of tinfoil is connected with a ring on the frame by a strip of tinfoil, so that it can be put in communication with the ground by means of a chain. To charge the pane the insulated side is connected with the machine. As the other side communicates with the ground, the two coatings play exactly the part of the condenser. On both plates there are accumulated large quantities of contrary electricities.

The pane may be discharged by simply pressing the knob of the discharger against the lower surface, while the other knob is brought near the upper coating. A spark ensues, due to the recombination of the two electricities; but the operator experiences no sensation, for the discharge

takes place through the wire. But if the connection between the two coatings be made by touching them with the hands, a violent shock is

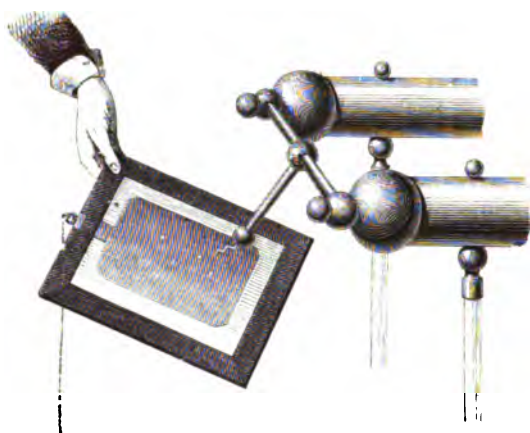

Fig. 602.

felt in the hands and breast, for the combination then takes place through the body.

748. **Leyden jar.**—The *Leyden jar*, so named from the town of Leyden, where it was invented, is nothing more than a modified condenser or fulminating pane rolled up. Fig. 603 represents a Leyden jar of the usual



Fig. 603.

French shape in the process of being charged. It consists of a glass bottle of any convenient size, the interior of which is either coated with tinfoil or filled with thin leaves of copper, or with gold leaf. Up to a certain distance from the neck the outside is coated with tinfoil. The neck is provided with a cork, through which passes a brass rod, which terminates at one end in a knob, and communicates with the metal in the interior. The metallic coatings are called respectively the *internal* and *external coatings*. Like the condenser, the jar is charged by connecting one of the coatings with the ground, and the other with the source of electricity. When it is held in the hand by the external coating, and the knob presented to the positive

conductor of the machine, positive electricity is accumulated on the inner and negative electricity on the outer coating. The reverse is the case if the jar is held by the knob, and the external coating presented to the machine. The positive charge acting inductively across the dielectric glass, decomposes the electricity of the outer coating, attracting the negative, and repelling the positive, which escapes by the hand to the ground. Thus it will be seen that the theory of the jar is identical with that of the condenser, and all that has been said of this applies to the jar, substituting the two coatings for the two plates, A and B, of fig. 599.

Like any other condenser, the Leyden jar may be discharged either slowly or instantaneously. For the latter purpose it is held in the hand by the outside coating (fig. 604), and the two coatings are then connected by means of



Fig. 604.



Fig. 605.

the simple discharger. Care must be taken to touch *first* the external coating with the discharger, otherwise a smart shock will be felt. To discharge it slowly the jar is placed on an insulated plate, and first the internal and then the external coating touched, either with the hand or with a metallic conductor. A slight spark is seen at each discharge.

Fig. 605 represents a very pretty experiment for illustrating the slow discharge. The rod terminates in a small bell, *d*, and the outside coating is connected with an upright metallic support, on which is a similar bell *e*. Between the two bells a light copper ball is suspended by a silk thread. The jar is then charged in the usual manner and placed on the support *m*. The internal coating contains a quantity of free electricity; the pendulum is attracted and immediately repelled, striking against the second bell, to which it imparts its free electricity. Being now neutralised, it is again attracted by the first bell, and so on for some time, especially if the air be dry, and the jar pretty large.

749. **Leyden jar with movable coatings.**—This apparatus (fig. 606) is used to demonstrate that in the Leyden jar, the opposite electricities are not distributed on the coatings merely, but reside principally on the opposite

sides of the glass. It consists of a somewhat conical glass vessel, B, with movable coatings of zinc or tin, C and D. These separate pieces placed one in the other, as shown in figure A, form a complete Leyden jar. After having charged the jar, it is placed on a cake of resin; the internal coating is first removed by the hand, or better a glass rod, and then the glass vessel. The coatings are found to contain little or no electricity, and if they are placed on the table they are restored to the neutral state. Nevertheless, when the jar

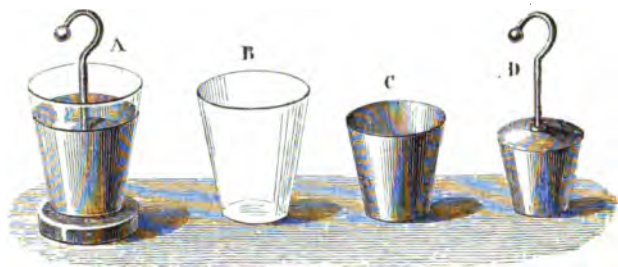

Fig. 606.

is put together again, as represented in the figure at A, a shock may be taken from it almost as strong as if the coatings had not been removed. It is therefore concluded that the coatings merely play the part of conductors, distributing the electricity over the surface of the glass, which thus becomes polarised, and retains this state even when placed on the table, owing to its imperfect conductivity.

The experiment may be conveniently made by forming a Leyden jar, of which the inside and outside coatings are of mercury, charging it; then having mixed the two coatings, the apparatus is put together again, upon which a discharge may be once more taken.

750. **Lichtenberg's figures.**—This experiment well illustrates the opposite electrical conditions of the two coatings of a Leyden jar. Holding a jar charged with positive electricity by the hand, a series of lines are drawn with the knob on a cake of resin or vulcanite; then having placed the jar on an insulator, it is held by the knob, and another series traced by means of the outer coating. If now an intimate mixture of red lead and flour of sulphur be projected on the cake, the sulphur will attach itself to the positive lines, and the red lead to the negative lines; the reason being that in mixing the powders the sulphur has become negatively electrified, and the red lead positively. The sulphur will arrange itself in tufts with numerous diverging branches, while the red lead will take the form of small circular spots, indicating a difference in the two electricities on the surface of the resin.

751. **Penetration of the charge. Residual charge.**—Not only do the electricities adhere to the two surfaces of the insulating medium which separates them, but they penetrate to a certain extent into the interior, as is shown by the following experiment. A condenser is formed of a plate of shellac, and movable metal plates. It is then charged, retained in that state for some time, and afterwards discharged. On removing the metal

coatings and examining both surfaces of the insulator, they show no signs of electricity. After some time, however, each face exhibits the presence of some electricity of the same kind as that of the plate with which it was in contact while the apparatus was charged. This can be explained by assuming that the electricity had slowly penetrated from the exterior to the interior during the first phase of the experiment, and had returned to the surface during the second.

A phenomenon frequently observed in Leyden jars is of the same nature. When a jar has been discharged and allowed to stand a short time, it exhibits a second charge, which is called the *electric residue*. The jar may be again discharged, and a second residue will be left, feebler than the first, and so on, for three or four times. Indeed with a delicate electroscope a long succession of such residues may be demonstrated. Time is required for the penetration of the electricities into the mass; and hence the residue is greater the longer the jar has remained charged. The magnitude of the residue further depends on the intensity of the charge, and also on the degree in which the metal plates are in contact with the insulator. It varies with the nature of the substance, but there is no residue with either liquids or gaseous insulators. Faraday found that with paraffin the residue was greatest, then with shellac, while with glass and sulphur it was least of all. Kohlrausch has found that the residue is nearly proportional to the thickness of the insulator.

752. **Electric batteries.**—The charge which a Leyden jar can take depends on the extent of the coated surface, and for small thicknesses is inversely



Fig. 607.

proportional to the thickness of the insulator. Hence, the larger and thinner the jar the more powerful the charge. But very large jars are expensive, and liable to break; and when too thin, the accumulated electricities are apt to discharge themselves through the glass, especially if it is not quite homo-

geneous. Leyden jars have usually from  $\frac{1}{2}$  to 3 square feet of coated surface. For more powerful charges electric batteries are used.

An *electric battery* consists of a series of Leyden jars, whose internal and external coatings are respectively connected with each other (fig. 607). They are usually placed in a wooden box lined on the bottom with tinfoil. This lining is connected with two metal handles in the sides of the box. The internal coatings are connected with each other by metallic rods, and the battery is charged by placing the internal coatings in connection with the prime conductor, while the outer coatings are connected with the ground by means of a chain fixed to the handles. A quadrant electrometer fixed to the jar serves to indicate the charge of the battery. Although there is a large quantity of electricity accumulated in the apparatus the divergence is not great, for it is simply due to the free electricity on the internal coating. The number of jars is usually four, six, or nine. The larger and more numerous they are, the longer is the time required to charge the battery, but the effects are so much the more powerful.

When a battery is to be discharged, the coatings are connected by means of the discharging rod, the outside coating being touched first. Great care is required, for with large batteries serious accidents may occur, resulting even in death.

**753. The universal discharger.**—This is an almost indispensable apparatus in experiments with the electric battery. On a wooden stand (fig. 608) are two glass legs, each provided with universal joints, in which movable brass rods are fitted. Between these legs is a small ivory table, on which is placed the object under experiment. The two metal knobs being directed towards the objects, one of them is connected with the external coating of the battery, and the moment communication is made between the other and the internal coating by means of the glass discharging rod, a violent shock passes through the object on the table.

**754. Charging by cascade.**—A series of Leyden jars are placed each separately on insulating supports. The knob of the first is in connection with the prime conductor of the machine, and its outer coating joined to the knob of the second, the outer coating of the second to the knob of the third, and so on; the outer coating of the last communicating with the ground. The inner coating of the first receives a charge of positive electricity from the machine, and the corresponding positive electricity set free by induction on its outer coating, instead of passing to the ground, gives a positive charge to the inner coating of the second, which, acting in like manner, develops a charge in the third jar, and so on, to the last, where the positive electricity developed by induction on the outer coating passes to the ground. The jars may be discharged either singly, by connecting the inner and outer coatings of each jar, or simultaneously by connecting the inner coating of the first with the outer of the last. In this way the quantity of electricity necessary to charge one jar is available for charging a series of jars.

For from the preceding explanation it is clear, that with a series of similar Leyden jars charged by cascade, if we call the charge of positive electricity which the inside of the first jar receives  $1$ , it will develop by induction on the outside a quantity  $m(m < 1)$  of negative electricity, and the same quantity  $m$  of positive electricity which will pass into the inside of the

second jar ; this in turn will develop  $m \times m = m^2$  of negative electricity on the outside of that jar, and the same quantity  $m^2$  of positive electricity will pass into the inside of the third jar, and so forth. Thus it will be seen that

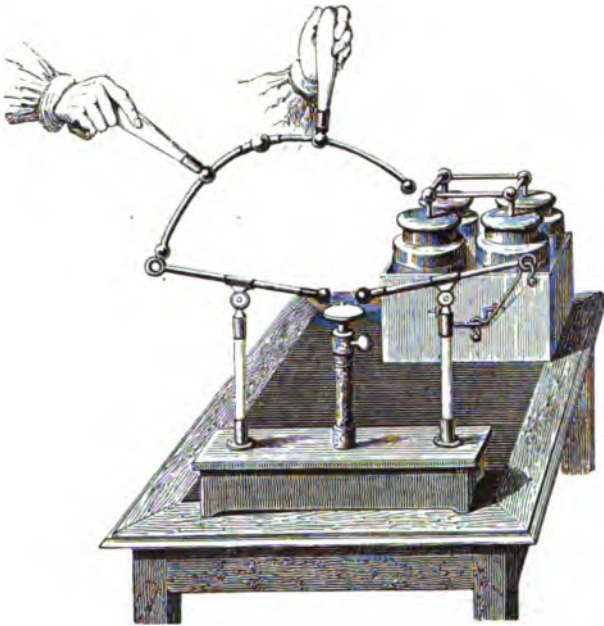

Fig. 608.

the quantities of positive electricity developed in a series of  $n$  similar jars by the unit charge of positive electricity will be

$$1 + m + m^2 + m^3 + \dots + m^{n-1} = \frac{1 - m^n}{1 - m},$$

and of negative electricity on the corresponding outsides of

$$m + m^2 + m^3 + m^4 + \dots + m^n = \frac{m(1 - m^n)}{1 - m}.$$

Thus, if there be six jars and  $m = 0.9$ , the quantity of positive electricity developed by the unit charge is 4.69.

If the external coatings of a charged and uncharged jar are placed in connection, and if the inner coatings are now connected, after separating them they are both found to be charged in the same manner. In this process a current has been produced between the outside coatings and one between the inner ones, to which Dove has given the name *charge current*, and which has all the properties of the ordinary discharge current.

755. **Measurement of the charge of a battery. Lanc's electrometer.**—When the outer and inner coatings of a charged Leyden jar are gradually brought nearer each other, at a certain distance a spontaneous



discharge ensues. The distance is called the *striking distance*. It is inversely proportional to the pressure of the air and directly proportional to the electric density of that point of the inner coating at which the discharge takes place. As the density of any point of the inner coating, other things remaining the same, is proportional to the entire charge, the striking distance is proportional to the quantity of electricity in a jar. The measurement of the charge of a battery, however, by means of the striking distance, can only take place when the charge disappears.

By means of Lane's electrometer, which depends on an application of this principle, the charge of a jar or battery may be measured. This apparatus, *c* (fig. 609), consists of an ordinary Leyden jar, near which there

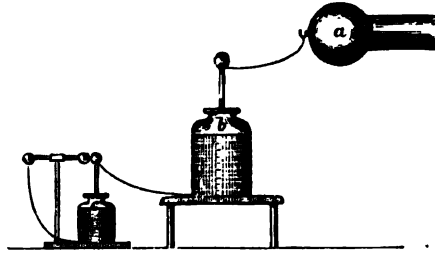

Fig. 609.

is a vertical metallic support. At the upper end is a brass rod, with a knob at one end, which can be placed in metallic connection with the outside of the jar: the rod being movable, the knob can be kept at a measured distance from the knob of the inner coating. Fig. 609 represents the operation of measuring the charge of a jar by means of this apparatus. The jar *b*, whose charge is to be measured, is placed on an insulated stool with its outer coating in metallic connection with the inner coating of Lane's jar *c*, the outer coating of which is in connection with the ground, or still better with a system of gas or water pipes; *a* is the conductor of the machine. When the machine is worked, positive electricity passes into the jar *b*; a proportionate quantity of positive electricity is repelled from its outer coating, passes into the inner coating of the electrometer, and there produces a charge. When this has reached a certain limit, it discharges itself between

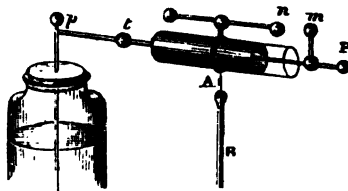

Fig. 610.

the two knobs, and as often as such a discharge takes place, the same quantity of positive electricity will have passed from the machine into the battery; hence its charge is proportional to the number of discharges of the electrometer.

Harris's unit jar (fig. 610) is an application of the same principle, and is very convenient for measuring quantities of electricity. It consists of a small Leyden phial 4 inches in length, and  $\frac{3}{4}$  of an inch in diameter coated to about an inch from the end,

so as to expose about 6 inches of coated surface. It is fixed horizontally on a long insulator, and the charging rod connected at P with the conductor of the machine, while the outer coating is connected with the jar or battery by the rod *tp*. When the accumulation of electricity in the interior has reached a certain height depending on the distance of the two balls *m* and *n*, a discharge ensues, and marks a certain quantity of electricity received as a charge by the battery, in terms of the small jar.

756. **Laws of electric charge.**—Harris, by means of experiments with the unit jar suitably modified, and Riess, by analogous arrangements, have found, by independent researches, that for small distances the striking distance is directly proportional to the quantity of electricity, and inversely proportional to the extent of coated surface; in other words it is proportional to the electric density. Thus, taking the surface of one jar as unity, if a battery of six Leyden jars charged by 100 turns of the machine has a striking distance of 9 millimetres, a battery of four similar jars charged by 120 turns will have the striking distance of 16·2 millimetres. For

$$\frac{100}{6} : 9 = \frac{120}{4} : x$$

$$\therefore x = 16\cdot2$$

The charge also depends on the nature of the glass, or other dielectric, of which the jar is made; and further, is stated by Wheatstone to be inversely proportional to the square of the thickness of the dielectric. Riess has also found that when a battery or jar is discharged in the striking distance, a charge still remains, for when the coatings are brought nearer, a similar discharge may be taken, and so on. The amount of this residual charge when the discharge takes place at the greatest striking distance is *always in the same proportion to the entire charge*. In Riess's experiments, 0·846 or  $\frac{11}{13}$  of the total charge disappeared, and only  $\frac{2}{13}$  remained.

757. **Volta's condensing electroscope.**—The condensing electroscope invented by Volta is a modification of the ordinary gold-leaf electroscope (728). The rod to which the gold leaves are affixed terminates in a disc instead of in a knob, and there is another disc of the same size provided with an insulating glass handle. The discs are covered with a layer of insulating shellac varnish (fig. 611).

To render very small quantities of electricity perceptible by this apparatus, one of the plates, which thus becomes the *collecting plate*, is touched with the body under examination. The other plate, the *condensing plate*, is connected with the ground by touching it with the finger. The electricity of the body, being diffused over the collecting plate, acts inductively through the varnish on the neutral fluid of the other plate, attracting the opposite electricity, but repelling that of like kind. The two electricities thus become accumulated on the two plates just as in a condenser, but there is no divergence of the leaves, for the opposite electricities counteract each other. The finger is now removed, and then the source of electricity, and still there is no divergence; but if the upper plate be raised (fig. 612) the neutralisation ceases, and the electricity being free to move diffuses itself over the rod and the leaves, which then diverge widely. The delicacy of the apparatus is increased by adapting to the foot of the apparatus two metallic rods, termina-

ting in knobs, for these knobs being excited by induction from the gold leaves react upon them.

A still further degree of delicacy is attained if the rods be replaced by two Bohnenberger's dry piles, one of which presents its positive and the other its



Fig. 611.

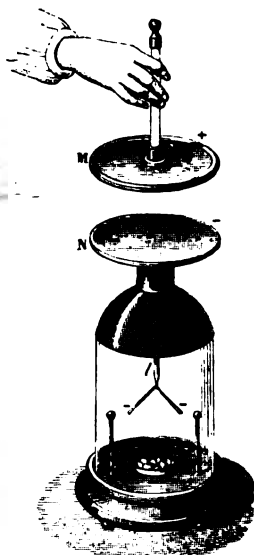

Fig. 612.

negative pole. Instead of two gold leaves there is only one ; the least trace of electricity causes it to oscillate either to one side or to the other, and at the same time shows the kind of electricity.

758. **Thomson's electrometer.**—Sir William Thomson has devised a new and delicate form of electrometer, by which quantitative measurements of the amount of electrical charge may be made. The principle of this instrument may be understood from the following description of a model of it constructed for lecture purposes by Mr. Becker.

A light flat broad aluminium needle hangs by a very thin wire from the inner coating of a charged Leyden jar, the outer coating being in conducting communication with the earth. The whole apparatus is enclosed within a glass shade and the air is kept dry by means of a dish of sulphuric acid ; there is, therefore, very little loss of electricity and the needle remains at a virtually constant charge.

The needle is suspended over four quadrantal metal plates insulated from each other and from the ground by resting on glass stands. The alternate quadrants are in conducting communication with each other by means of wires. If now all the quadrants are in the same electrical condition, the needle will be at rest when it is directly over one of the diametrical slits. But if the two pairs of quadrants are charged with opposite kinds of elec-

tricity, as when, for instance, they are connected with the two poles of an insulated voltaic cell by means of the knobs, then each end of the needle will be repelled by the pair of quadrants which are electrified like itself, and will be attracted by the other pair. It will thus be subject to the action of a couple tending to set it obliquely to the slit.

In order to render the slightest motion of the needle visible, a small silver concave mirror with a radius of about a metre is fixed above it. The light of a petroleum lamp, not represented in the figure, strikes against this and is reflected as a spot on a horizontal scale. Any deflection of the needle either on one side or the other, is indicated by the motion of the spot of light on the scale (508).



Fig. 613.

#### THE ELECTRIC DISCHARGE.

##### 759. Effects of the electric discharge. —

The recombination of the two electricities which constitutes the electrical discharge may be either continuous or sudden; *continuous*, or of the nature of a current, as when the two conductors of a Holtz's machine are joined by a chain or a wire; and *sudden*, as when the opposite electricities accumulate on the surface of two adjacent conductors, till their mutual attraction is strong enough to overcome the intervening resistances, whatever they may be. But the difference between a sudden and a continuous discharge is one of degree, and not of kind, for there is no such thing as an absolute non-conductor, and the very best conductors, the metals, offer an appreciable resistance to the passage of electricity. Still the difference at the two extremes of the scale is sufficiently great to give rise to a wide range of phenomena.

Riess has shown that the discharge of a battery does not consist in a simple union of the positive and negative electricity, but that it consists of a series of successive partial discharges. The direction of the discharge depends mainly on the length and nature of the circuit. By observations of the image of the spark in a rotating mirror, and of the luminous phenomena at the positive and negative poles when the discharge takes place in highly rarefied gases, as well as by the manner in which a magnet affects the phenomena of discharge, Feddersen and Paalzow have shown that the discharge consists of a series of oscillating currents alternately in opposite directions. As the resistance of the circuit increases, the number of these alternating discharges decreases, but at the same time their duration is greater. With very great resistance, as for instance when a wet thread is interposed, the alternating discharge becomes a single one.

The phenomena of the discharge are usually divided into the *physiological, luminous, mechanical, magnetical, and chemical effects.*

**760. Physiological effects.**—The physiological effects are those produced on living beings, or on those recently deprived of life. In the first case they consist of a violent excitement which the electric fluid exerts on the sensibility and contractility of the organic tissues through which it passes; and in the latter, of violent muscular convulsions which resemble a return to life.

The shock from the electrical machine has been already noticed (740). The shock taken from a charged Leyden jar by grasping the outer coating with one hand and touching the inner with the other, is much more violent, and has a peculiar character. With a small jar the shock is felt in the elbow; with a jar of about a quart capacity it is felt across the chest, and with jars of still larger dimensions in the stomach.

A shock may be given to a large number of persons simultaneously by means of the Leyden jar. For this purpose they must form a chain by joining hands. If then the first touches the outside coating of a charged jar, while the last at the same time touches the knob, all receive a simultaneous shock, the intensity of which depends on the charge, and on the number of persons receiving it. Those in the centre of the chain are found to receive a less violent shock than those near the extremities. The Abbé Nollet discharged a Leyden jar through an entire regiment of 1,500 men, who all received a violent shock in the arms and shoulders.

With large Leyden jars and batteries the shock is sometimes very dangerous. Priestley killed rats with batteries of 7 square feet coated surface, and cats with a battery of about  $4\frac{1}{2}$  square yards coating.

**761. Luminous effects.**—The recombination of two electricities of high potential (775) is always accompanied by a disengagement of light, as is seen when sparks are taken from a machine, or when a Leyden jar is discharged. The better the conductors on which the electricities are accumulated, the more brilliant is the spark; its colour varies not only with the nature of the bodies, but also with the nature of the surrounding medium and with the pressure. The spark between two charcoal points is yellow, between two balls of silvered copper it is green, between knobs of wood or ivory it is crimson. In atmospheric air at the ordinary pressure the electric spark is white and brilliant; in rarefied air it is reddish; and in vacuo it is violet. In oxygen, as in air, the spark is white; in hydrogen it is reddish and green in the vapour of mercury; in carbonic acid it is also green, while in nitrogen it is blue or purple, and accompanied by a peculiar sound. Generally speaking, the higher the potential the greater is the lustre of the spark. It is asserted by Fusinieri that in the electric spark there is always a transfer of material particles in a state of extreme tenuity, in which case the modifications in colour must be due to the transport of ponderable matter.

When the spark is viewed through a prism, the spectrum obtained is full of dark lines (558), the number and arrangement of which depend on the nature of the poles.

**762. Spark and brush discharge.**—The shapes which luminous electric phenomena assume may be classed under two heads—the *spark* and the *brush*. The brush forms when the electricity leaves the conductor in a continuous flow; the spark, when the discharge is discontinuous. The formation of one

or the other of these depends on the nature of the conductor and on the nature of the conductors in its vicinity ; and small alterations in the position of the surrounding conductors transform the one into the other.

The spark which at short distances appears straight, at longer distances has a zigzag-shape with diverging branches. Its length depends on the density at the part of the conductor from which it is taken ; and to obtain the longest sparks the electricity must be of as high density as possible, but not so high as to discharge spontaneously. With long sparks the luminosity is different in different parts of the spark.

The brush derives its name from the radiating divergent arrangement of the light, and presents the appearance of a luminous cone, whose apex touches the conductor. Its size and colour differ with the nature and form of the conductor ; it is accompanied by a peculiar hissing noise, very different from the sharp crack of the spark. Its luminosity is far less than that of the spark, for while the latter can easily be seen by daylight, the former is only visible in a darkened room. The brush discharge may be obtained by placing on the conductor a wire filed round at the end, or, with a powerful machine, by placing a small bullet on the conductor. The brush from a negative conductor is less than from a positive conductor ; the cause of this difference has not been satisfactorily made out, but may originate in the fact, which Faraday has observed, that negative electricity discharges into the air at a somewhat lower density than positive electricity ; so that a negatively charged knob sooner attains that density at which spontaneous discharge takes place, than does a positively charged one, and therefore discharges the electricity at smaller intervals and in less quantities.

When electricity, in virtue of its high density, issues from a conductor, no other conductor being near, the discharge takes place without noise, and at the places at which it appears there is a pale blue luminosity called the *electrical glow*, or on points, a star-like centre of light. It is seen in the dark by placing a point on the conductor of the machine.

763. **Electric egg.**—The influence of the pressure of the air on the electric light may be studied by means of the *electric egg*. This consists of an ellipsoidal glass vessel (fig. 614), with metal caps at each end. The lower cap is provided with a stopcock, so that it can be screwed into an air pump, and also into a heavy metallic foot. The upper metal rod moves up and down in a leather stuffing box ; the lower one is fixed to the cap. A vacuum having been made, the stopcock is turned, and the vessel screwed into its foot ; the upper part is then connected with a powerful electrical machine, and the lower one with the ground. On working the machine, the globe becomes filled with a feeble violet light continuous from one end to the other, and resulting from the recombination of the positive fluid of the upper



Fig. 614.

cap with the negative of the lower. If the air be gradually allowed to enter by opening the stopcock, the light now appears white and brilliant, and is only seen as an ordinary intermittent spark.

Some beautiful effects of the electric light are obtained by means of Geissler's tubes, which will be noticed under Dynamical Electricity.

764. **Luminous tube, square, and bottle.**—The *luminous tube* (fig. 615) is a glass tube about a yard long, round which are arranged in a spiral form



Fig. 615.

a series of lozenge-shaped pieces of tinfoil, between which are very short intervals. There is a brass cap with hooks at each end, in which the spiral terminates. If one end be presented to a machine in action, while the other is held in the hand, sparks appear simultaneously at each interval and produce a brilliant luminous appearance, especially in the dark.

The *luminous pane* (fig. 616) is constructed on the same principle, and consists of a square of ordinary glass, on which is fastened a narrow strip of

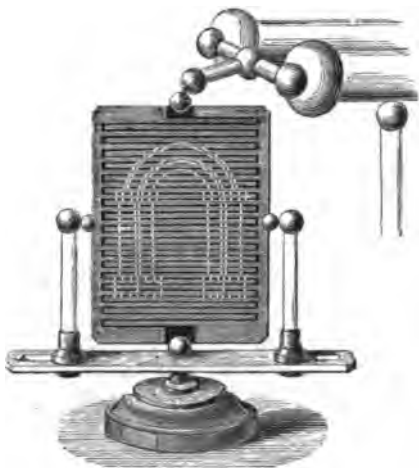

Fig. 616.

tinfoil folded parallel to itself for a great number of times. Spaces are cut out of this strip so as to represent any figure, a portico for example. The pane being fixed between two insulating supports, the upper extremity of the

strip is connected with the electrical machine, and the lower part with the ground. When the machine is in operation, a spark appears at each interval, and reproduces in luminous flashes the object represented on the glass.

The *luminous jar* (fig. 617) is a Leyden jar, whose outer coating consists of a layer of varnish strewed over with metallic powder. A strip of tin fitted on the bottom is connected with the ground by means of a chain: a second band at the upper part of the coating has a projecting part and the rod of the bottle is curved so that the knob is about  $\frac{3}{4}$  of an inch from the projection. This jar is suspended from the machine, and as rapidly as this is worked, large and brilliant sparks pass between the knob and the outer coating, illuminating the outside of the apparatus.

765. **Heating effects.**— Besides being luminous, the electric spark is a source of intense heat. When it passes through inflammable liquids, as ether or alcohol, it inflames them. An arrangement for effecting this is represented in fig. 618. It is a small glass cup through the bottom of which



Fig. 617

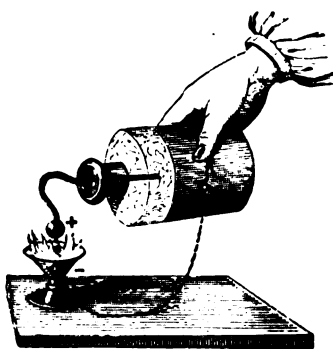

Fig. 618.

passes a metal rod, terminating in a knob and fixed to a metal foot. A quantity of liquid sufficient to cover the knob is placed in the vessel. The outer coating of the jar having been connected with the foot by means of a chain, the spark which passes when the two knobs are brought near each other inflames the liquid. With ether the experiment succeeds very well, but alcohol requires to be first warmed.

Coal gas may also be ignited by means of the electric spark. A person



standing on an insulated stool places one hand on the conductor of a machine which is then worked, while he presents the other to the jet of gas issuing from a metallic burner. The spark which passes ignites the gas.

When a battery is discharged through an iron or steel wire it becomes heated, and even made incandescent or melted, if the discharge is very powerful.

The laws of this heating effect have been investigated independently by Harris and by Riess by means of the *electric thermometer*. This is essentially an air thermometer, across the bulb of which is a fine platinum wire. When a discharge is passed through the wire it becomes heated, expands the air in the bulb, and this expansion is indicated by the motion of the liquid along the graduated stem of the thermometer. In this way it has been found that the increase in temperature in the wire is proportional to the electric density multiplied by the quantity of electricity; and since the electric density is equal to the quantity of electricity—usually measured by the number of discharges of the unit jar (755), divided by the surface, the heating effect is proportional to the square of the number of discharges divided by the surface; that is,  $h = \frac{q^2}{s}$ .

Riess has also found that *with the same charge, but with wires of different dimensions, the rise of temperature is inversely as the fourth power of the diameter*. Thus, compared with a given wire as unity, the *rise of temperature* in a wire of double or treble the diameter would be  $\frac{1}{16}$  or  $\frac{1}{81}$  as small; but as the masses of these wires are four and nine times as great, *the heat produced* would be respectively  $\frac{1}{4}$  and  $\frac{1}{9}$  as great as in a wire of unit thickness.

When an electric discharge is sent through gunpowder placed on the table of a Henley's discharger, it is not ignited, but is projected in all directions. But if a wet string be interposed in the circuit a spark passes which ignites the powder. This arises from the retardation which electricity experiences in traversing a semi-conductor, such as a wet string: for the heating effect is proportional to the duration of the discharge.

When a charge is passed through sugar, heavy spar, flourspar, and other substances, they afterwards become phosphorescent in the dark. Eggs, fruit, etc., may be made luminous in the dark in this way.

When a battery is discharged through a gold leaf, pressed between two glass plates or between two silk ribbons, the gold is volatilised in a violet powder which is finely divided gold. In this way what are called *electric portraits* are obtained.

Siemens has shown that when a jar is charged and discharged several times in succession the glass becomes heated. Hence during the discharge there must be movements of the molecules of the glass, as Faraday supposed.

766. **Magnetic effects.**—By the discharge of a large Leyden jar or battery, a steel wire may be magnetised if it is laid at right angles to a conducting wire through which the discharge is effected, either in contact with the wire or at some distance. And even with less powerful discharges, a steel bar or needle may be magnetised by placing it inside a tube on which is coiled a fine insulated copper wire. On passing the discharge through this wire the steel becomes magnetised.

To effect a deflection of the magnetic needle by the electric current pro-

duced by frictional electricity is more difficult. It may be accomplished by making use of a galvanometer consisting of 400 or 500 turns of fine silk-covered wire, which is further insulated by being coated with shellac varnish, and by separating the layers by means of oiled silk. When the prime conductor of a machine in action is connected with one end of the galvanometer wire, and the other with the ground, a deflection of the needle is produced.

767. **Mechanical effects.**—The mechanical effects are the violent lacerations, fractures, and sudden expansions which ensue when a powerful discharge is passed through a badly-conducting substance. Glass is perforated,

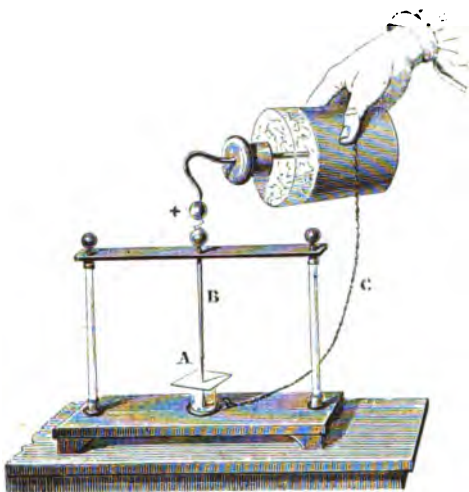

Fig. 619.

wood and stones are fractured, and gases and liquids are violently disturbed. The mechanical effects of the electric spark may be demonstrated by a variety of experiments.

Figure 619 represents an arrangement for perforating a piece of glass or card. It consists of two glass columns, with a horizontal cross-piece, in which is a pointed conductor, B. The piece of glass, A, is placed on an insulating glass support, in which is placed a second conductor, terminating also in a point, which is connected with the outside of the battery, while the knob of the inner coating is brought near the knob of B. When the discharge passes between the two conductors the glass is perforated. The experiment only succeeds with a single jar when the glass is very thin; otherwise a battery must be used.

The perturbation and sudden expansion which the discharge produces may be illustrated by means of Kinnersley's thermometer. This consists of two glass tubes (fig. 620), which fit into metallic caps, and communicate with each other. At the top of the large tube is a rod terminating in a knob, and moving in a stuffing-box, and at the bottom there is a similar rod with a knob. The apparatus contains water up to the level of the lower knob.

When the electric shock passes between the two knobs, the water is driven out of the larger tube and rises to a slight extent in the small one. The

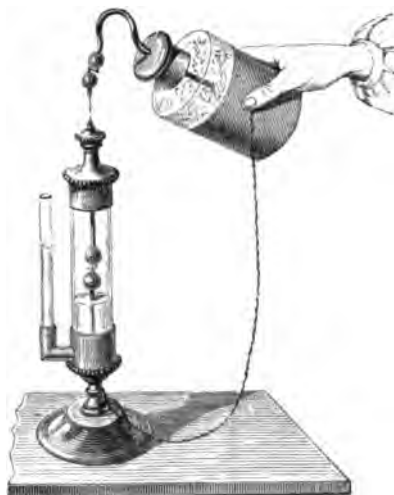

Fig. 620.

level is immediately re-established, and therefore the phenomenon is not due to an increase of temperature.

For the production of mechanical effects the universal discharger, fig. 608, is of great service. A piece of wood, for instance, placed on the table between the two conductors, is split when the discharge passes.

**768. Chemical effects.**—The chemical effects are the decompositions and recombinations effected by the passage of the electric discharge. When two gases which act on each other are mixed in the proportions in which they combine, a single spark is often sufficient to determine their combination; but when either of them is in great excess, a succession of sparks is necessary. Priestley found that when a series of electric sparks was passed through moist air, its volume diminished, and blue litmus introduced into the vessel was reddened. This, Cavendish discovered, was due to the formation of nitric acid.

Several compound gases are decomposed by the continued action of the electric spark. With olefiant gas, sulphuretted hydrogen, and ammonia, the decomposition is complete; while carbonic acid is partially decomposed into oxygen and carbonic oxide. The electric discharge also by suitable means can feebly decompose water, oxides, and salts; but though the same in kind, the chemical effects of statical electricity are by no means so powerful and varied as those of dynamical electricity. The chemical action of the spark is easily demonstrated by means of a solution of iodide of potassium. A small lozenge-shaped piece of filtering paper, impregnated with iodide of potassium, is placed on a glass plate, and one corner connected with the

ground. When a few sparks from a conductor charged with positive electricity are taken at the other corner, brown spots are produced, due to the separation of iodine.

Among the chemical effects must be enumerated the formation of *ozone*, which is recognised by its peculiar odour and by certain chemical properties. The odour is perceived when electricity issues through a series of points from a conductor into the air. Its true nature is not accurately known ; but it is probably an allotropic modification of oxygen.

The *electric pistol* is a small apparatus which serves to demonstrate the chemical effects of the spark. It consists of a brass vessel (fig. 621), in

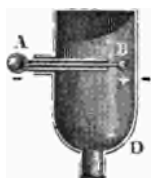

Fig. 621.

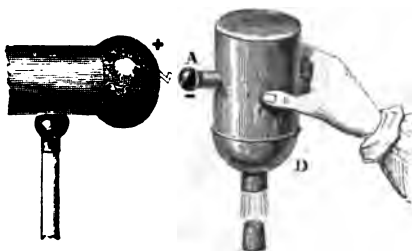

Fig. 622.

which is introduced a detonating mixture of two volumes of hydrogen and one of oxygen, and which is then closed with a cork. In a tubulure in the side there is a glass tube, in which fits a metal rod, terminated by the knobs A and B. The vessel is held as represented in fig. 622, and brought near the machine. The knob A becomes negatively, and B positively electrified by induction from the machine, and a spark passes between the conductor and A. Another spark passes at the same time between the knob B and the side ; this determines the combination of the gases, which is accompanied by a great disengagement of heat, and the vapour of water formed acquires such an expansive force, that the cork is projected with a report like that of a pistol.

769. **Application of the electrical discharge to firing mines.**—By the labours of Prof. Abel in this country, and of Baron von Ebner in Austria, the electrical discharge has been applied to firing mines for military purposes, and the methods have acquired a high degree of perfection. The principle on which the method is based may be understood from the following statement :

One end of an insulated wire in which is a small break is placed in contact with the outside of a charged Leyden jar, the other end being placed near the inner coating. If now this end be brought in contact with the inner coating the jar is discharged and a spark strikes across the break ; and if there be here some explosive compound it is ignited, and this ignition may of course be communicated to any gunpowder in which it is placed. If on one side of the break, instead of having an insulated wire direct back to the outer coating of the Leyden jar, an uncovered wire be led into the ground,

the outside of the jar being also connected with the ground, the result is unchanged, the earth acting as a return wire. Moreover, if there be several breaks; the explosion will still ensue at each of them, provided the charge be sufficiently powerful.

In the actual application it is of course necessary to have an arrangement for generating frictional electricity which shall be simple, portable, powerful, and capable of working in any weather. In these respects the electrical machine devised by Von Ebner is admirable. Fig. 623 represents

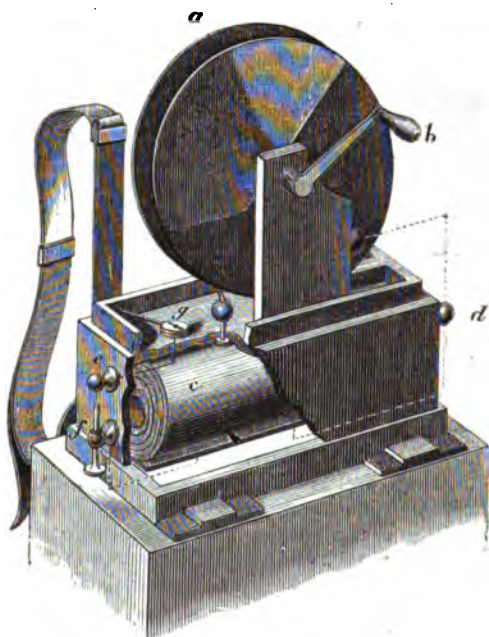

Fig. 623.

a view of this instrument as constructed by Messrs. Elliott, part of the case being removed to show the internal construction.

It consists of two circular plates of ebonite, *a*, mounted on an axis so that they are turned by a handle, *b*, between rubbers, which are so arranged as to be easily removed for the purposes of amalgamation, etc. Fastened to a knob on the base of the apparatus and projecting between the plates is a pointed brass rod, which acts as a collector of the electricity. The condenser or Leyden jar arrangement is inside the case, part of which has been removed to show the arrangement. It consists of India-rubber cloth, coated on each side with tinfoil, and formed into a roll for the purpose of greater compactness. By means of a metal button the knob is in contact with one tinfoil coating, which thus receives the electricity of the machine, and corresponds to the inner coating of the Leyden jar. Another button, connected

with the other tinfoil coating, rests on a brass band at the base of the apparatus which is in metallic contact with the cushions, the knob *d*, and the perforated knob in which slides a rod at the front of the apparatus. These are all in connection with the earth. The knob *e* is in metallic connection with a disc *g* provided with a light arm. By means of a flexible chain this is so connected with a trigger on the side of the apparatus, not represented in the figure, that when the trigger is depressed, the arm, and therewith the knob *e*, is brought into contact with the inner coating of the condenser.

On depressing the trigger, after a certain number of turns, a spark passes between the knob *e* and the sliding rod, and the striking distance is a measure of the working condition of the instrument.

The fuse used is known as *Abel's electrical fuse*, and has the following construction. The ends of two fine copper wires, fig. 625, are imbedded in a



Fig. 624.

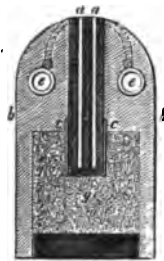

Fig. 625.

thin solid gutta-percha rod, parallel to each other, but at a distance of about 1.5 mm. At the lower end of the gutta-percha a small cap of paper or tinfoil *cc* is fastened, in which is placed a small quantity of the priming composition, which consists of an intimate mixture of subsulphide of copper, subphosphide of copper, and chlorate of potassium. The paper is fastened down so that the exposed ends of the wires are preserved in close contact with the powder.

This is the actual fuse; for service the capped end of the fuse is placed in a perforation in the rounded head of a wooden cylinder, so as to project slightly into the cavity *g* of the cylinder. This cavity is filled with meal powder which is well rammed down, so that the fuse is firmly imbedded. It

is afterwards closed by a plug of gutta-percha, and the whole is finally coated with black varnish.

The free ends of the wires *a a* are pressed into small grooves in the head of the cylinder (fig. 625), and each end is bent into one of the small channels with which the cylinder is provided, and which are at right angles to the central perforation. They are wedged in here by driving in small copper tubes, the ends of which are then filed flush with the surface of the cylinder. The bared ends of two insulated conducting wires are then pressed into one of the small copper tubes or eyes, and fixed there by bending the wire round on to the wood, as shown at *e*.

The conducting wire used in firing may be thin, but it must be well insulated. One end, which is bared, having been pressed into the hole *d* of the fuse (fig. 624), the other is placed near the exploder: Into the other hole *d'* of the fuse a wire is placed which serves as earth wire, care being taken that there is no connection between the two wires. The fuse having been introduced into the charge, the earth wire is placed in good connection with the ground. The knob *f* of the exploder is also connected with the earth by leading uncovered wire into water or moist earth, and the condition of the machine tested. The end of the insulated wire is then connected with the knob *e* and the rod drawn down; at the proper signal the handle is turned the requisite number of times, and when the signal is given the trigger is depressed, and the explosion ensues.

When a number of charges are to be fired they are best placed in a single circuit, care being taken that the insulation is good.

770. **Duration of the electric spark.**—Wheatstone measured the duration of the electric spark, by means of the rotating mirror which he invented for this purpose. At some distance from this instrument, which can be made to rotate with a measured velocity, a Leyden jar is so arranged that the spark of its discharge is reflected from the mirror. Now, from the laws of reflection (506) the image of the luminous point describes an arc of double the number of degrees which the mirror describes, in the time in which the mirror passes from the position in which the image is visible to that in which it ceases to be so. If the duration of the image were absolutely instantaneous the arc would be reduced to a mere point. Knowing the number of turns which the mirror makes in a second, and measuring, by means of a divided circle, the number of degrees occupied by the image, the duration of the spark would be determined. In one experiment Wheatstone found that this arc was  $24^\circ$ . Now, in the time in which the mirror traverses  $360^\circ$  the image traverses  $720^\circ$ ; but in the experiment the mirror made 800 turns in a second, and therefore the image traversed  $576,000^\circ$  in this time; and as the arc was  $24^\circ$ , the image must have lasted the time expressed by  $\frac{24}{576000}$  or  $\frac{1}{24000}$  of a second. Thus the discharge is not instantaneous, but has a certain duration, which, however, is excessively short.

Feddersen found that when greater resistances were interposed in the circuit through which the discharge was effected, the duration of the spark was increased. With a tube of water 9 mm. in length, the spark lasted 0.0014 second; and with one of 180 mm. its duration was 0.0183 second. The duration increased also with the striking distance, and with the dimensions of the battery.

To determine the duration of the electric spark MM. Lucas and Cazin have used a most accurate method, by which it may be measured in millionths of a second. The method is an application of the vernier. A disc of mica 15 centimetres in diameter is blackened on one face, and at the edge are traced 180 equal divisions in very fine transparent lines. The disc is mounted on a horizontal axis, and by means of a gas engine it may be made

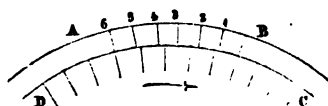

Fig. 626.

to turn with a velocity of 100 to 300 turns in a second. A second disc of silvered glass of the same radius is mounted on the same axis as the other and very close to it; at its upper edge six equidistant transparent lines are traced, forming a vernier with the lines on the mica. For this, the distance between two consecutive lines on the two discs is such that five divisions of the mica disc DC, correspond to six divisions of the glass disc AB as seen in figure 626. Thus the vernier gives the sixths of a division of the mica disc (10). In the apparatus the lines AB are not above the lines CD, but are at the same distance from the axis, so that the latter coincide successively with the former.

The mica disc is contained in a brass box D (fig. 627), on the hinder face of which is fixed the vernier. In the front face is a glass window O, through which the coincidence of the two sets of lines can be observed by means of a magnifying lens L.

The source of electricity is a battery of 2 to 8 jars, each having a coated surface of 1,243 square centimetres and charged continuously by a Holtz's machine. The sparks strike between two metal bulbs *a* and *b*, 11 millimetres in diameter. Their distance can be varied, and at the same time measured, by means of a micrometric screw, *r*. The two opposite electricities arrive by wires *m* and *n*, and the sparks strike at the principal focus of a condensing lens placed in the collimator C, so that the rays which fall on the vernier are parallel.

The motion is transmitted to the toothed wheels and to the mica disc by means of an endless band, which can be placed on any one of three pulleys P, so that the velocity may be varied. At the end of the axis of the pulleys is a bent wire which moves a counter, V, that marks on three dials the number of turns of the disc.

These details being premised, suppose the velocity of the disc is 400 turns in a second. In each second  $400 \times 180$  or 72,000 lines pass before the observer's eye in each second; hence an interval of  $\frac{1}{72000}$  of a second elapses between two consecutive lines. But as the spark is only seen when one of the lines of the disc coincides with one of the six lines of the vernier; and as this gives sixths of a division of the movable disc, when the latter has turned through a sixth of a division, a second coincidence is produced; so that the interval between two successive coincidences is

$$\frac{1}{72000 \times 6} = 0.0000023 \text{ of a second.}$$



That being the case, let the duration of a spark be something between 23 and 46 ten-millionths of a second; if it strikes exactly at the moment of a coincidence, it will last until the next coincidence; and owing to the persistence of impressions on the retina (607) the observer will see two luminous lines. But if the spark strikes between two coincidences and has ceased

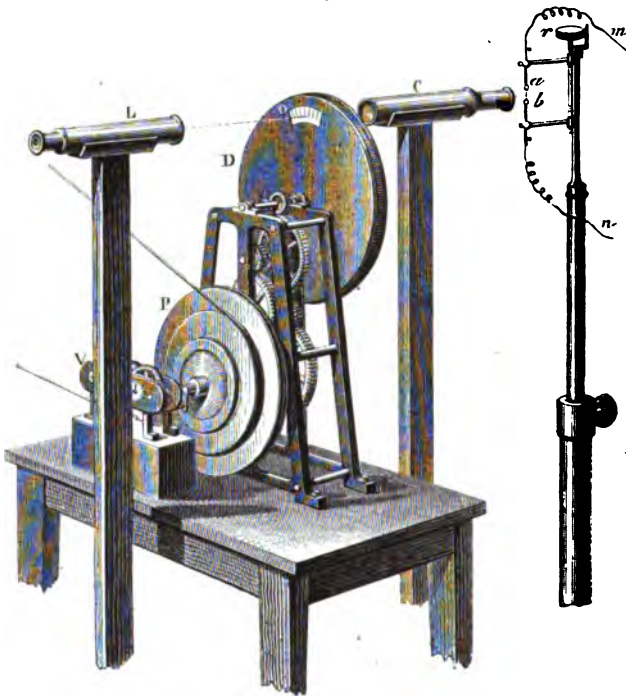

Fig. 627.

when the third is produced only one brilliant line is seen. Thus, if with the above velocity sometimes 1 and sometimes 2 bright lines are seen, the duration of the spark is comprised between 23 and 46 ten-millionths of a second.

By experiments of this kind, with a striking distance of 5 millimetres between the balls *a* and *b*, and varying the number of the jars, MM. Lucas and Cazin obtained the following results:

Number of jars.	Duration in millionths of a second.
2	26
4	41
6	47
8	45

It will thus be seen that the duration of the spark increases with the

number of jars. It also increases with the striking distance ; but it is independent of the diameter of the balls between which the spark strikes.

The spark of electrical machines has so short a duration that it could not be measured with the chronoscope.

**771. Velocity of electricity.**—To determine the velocity of electricity, Wheatstone constructed an apparatus the principle of which will be understood from fig. 628 ; six insulating metal knobs were arranged in a horizontal line on a piece of wood called a *spark board* ; of these the knob 1 was connected with the outer, while 6 could be connected with the inner coating of a charged Leyden jar ; the knob 1 was a tenth of an inch distant from the knob 2 ; while between 2 and 3 a quarter of a mile of insulated wire was interposed : 3 was likewise a tenth of an inch from 4, and there was a quarter of a mile of wire between 4 and 5 ; lastly, 5 was a tenth of an inch from 6, from which a wire led directly to the outer coating of the Leyden jar. Hence, when the jar was discharged by connecting the wire from 6 with the inner coating of the jar, sparks would pass between 1 and 2, between 3 and 4, and between 5 and 6. Thus the discharge, supposing it to proceed from the inner coating, has to pass in its course through a quarter of a mile of wire between the first and second spark, and through the same distance between the second and third.

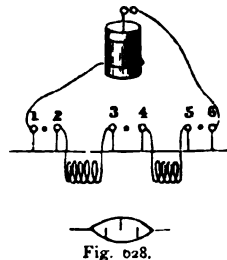

The spark board was arranged at a distance of 10 feet from the rotating mirror, and at the same height, both being horizontal ; and the observer looked down on the mirror. Thus the sparks were visible when the mirror made an angle of  $45^\circ$  with the horizon.

Now, if the mirror were at rest or had only a small velocity, the images of the three sparks would be seen as three dots ;, but when the mirror had a certain velocity these dots appeared as lines, which were longer as the rotation was more rapid. The greatest length observed was  $24^\circ$ , which, with 800 revolutions in a second, can be shown to correspond to a duration of  $\frac{1}{24000}$  of a second. With a slow rotation the lines present the appearance      ; they are quite parallel, and the ends in the same line. But with greater velocity, and when the rotation took place from left to right, they presented the appearance     , and when it turned from right to left the appearance     , because the image of the centre spark was formed after the lateral ones. Wheatstone found that this displacement amounted to half a degree before or behind the others. This arc corresponds

to a duration of  $\frac{1}{2 \times 720 \times 800}$  or  $\frac{1}{1152000}$  of a second ; the space traversed in this time being a quarter of a mile, gives, for the velocity of electricity, 288,000 miles in a second, which is greater than that of light. The velocity of dynamical electricity is far less ; and owing to induction, the transmission of a current through submarine wires is comparatively slow.

In the above experiment the images of the two outer sparks appear simultaneously in the mirror, from which it follows that the electric current issues simultaneously from the two coatings of the Leyden jar.

From certain theoretical considerations based upon measurements of constant electrical currents Kirchoff has concluded that the motion of electricity in a wire in which it meets with no resistance is like that of a wave on a stretched string, and has the velocity of 192,924 miles in a second, which is about that of light in vacuo (493).

According to Walker, the velocity of electricity is 18,400 miles, and according to Fizeau and Gounelle, it is 62,100 miles in iron, and 111,780 in copper wire. These measurements, however, were made with telegraph wires, which induce opposite electricities in the surrounding media; there is thus produced a resistance which diminishes the velocity. The velocity is less therefore in water than in air. The nature of the conductor appears to have some influence on the velocity; but not the thickness of the wire, nor the tension of the electricity.

For atmospheric electricity, reference must be made to the chapter on Meteorology.

## BOOK X.

## DYNAMICAL ELECTRICITY.

## CHAPTER I.

## VOLTAIC PILE. ITS MODIFICATIONS.

X 772. **Galvani's experiment and theory.**—The fundamental experiment which led to the discovery of dynamical electricity is due to Galvani, professor of anatomy in Bologna. Occupied with investigations on the influence of electricity on the nervous excitability of animals, and especially of the frog,

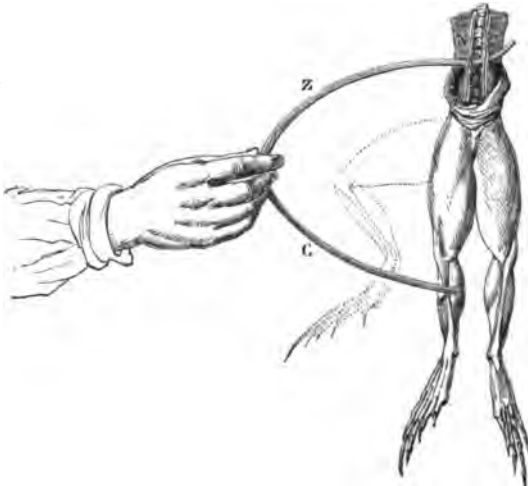

Fig. 629.

he observed that when the lumbar nerves of a dead frog were connected with the crural muscles by a metallic circuit, the latter became briskly contracted.

To repeat this celebrated experiment, the legs of a recently killed frog are prepared, and the lumbar nerves on each side of the vertebral column are exposed in the form of white threads. A metal conductor, composed of

G G

zinc and copper, is then taken (fig. 62), and one end introduced between the nerves and the vertebral column, while the other touches one of the muscles of the thighs or legs; at each contact a smart contraction of the muscles ensues.

Galvani had some time before observed that the electricity of machines produced in dead frogs analogous contractions, and he attributed the phenomena first described to an electricity inherent in the animal. He assumed that this electricity, which he called *vital fluid*, passed from the nerves to the muscles by the metallic arc, and was thus the cause of contraction. This theory met with great support, especially among physiologists, but it was not without opponents. The most considerable of these was Alexander Volta, professor of physics in Pavia.

773. **Volta's fundamental experiment.**—Galvani's attention had been exclusively devoted to the nerves and muscles of the frog; Volta's was directed upon the connecting metal. Resting on the observation, which Galvani had also made, that the contraction is more energetic when the connecting arc is composed of two metals, than when there is only one, Volta attributed to the metals the active part in the phenomenon of contraction. He assumed that the disengagement of electricity was due to their contact, and that the animal parts only officiated as conductors, and at the same time as a very sensitive electroscope.)

By means of the condensing electroscope, which he had then recently invented, Volta devised several modes of showing the disengagement of electricity on the contact of metals, of which the following is the easiest to perform :

The moistened finger being placed on the upper plate of a condensing electroscope (fig. 611), the lower plate is touched with a plate of copper, *c*, soldered to a plate of zinc, *z*, which is held in the other hand. On breaking the connection and lifting the upper plate (fig. 612), the gold leaves diverge, and, as may be proved, with negative electricity. Hence, when soldered together, the copper is charged with negative electricity, and the zinc with positive electricity. The electricity could not be due either to friction or pressure; for if the condensing plate, which is of copper, is touched with the zinc plate *z*, the copper plate to which it is soldered being held in the hand, no trace of electricity is observed.

A memorable controversy arose between Galvani and Volta. The latter was led to give greater extension to his contact theory, and propounded the principle that when *two heterogeneous substances are placed in contact, one of them always assumes the positive and the other the negative electrical condition*. In this form Volta's theory obtained the assent of the principal philosophers of his time. Galvani, however, made a number of highly interesting experiments with animal tissues. In some of these he obtained indications of contraction, even though the substances in contact were quite homogeneous.

774. **Disengagement of electricity in chemical actions.**—The contact theory which Volta had propounded, and by which he explained the action of the pile, soon encountered objectors. Fabroni, a countryman of Volta, having observed that in the pile the discs of zinc became oxidised in contact with the acidulated water, thought that this oxidation was the principal

cause of the disengagement of electricity. In England Wollaston soon advanced the same opinion, and Davy supported it by many ingenious experiments.

It is true that in the fundamental experiment of the contact theory (773) Volta obtained signs of electricity. But De la Rive showed that if the zinc be held in a wooden clamp, all signs of electricity disappear, and that the same is the case if the zinc be placed in gases, such as hydrogen or nitrogen, which exert upon it no chemical action. De la Rive accordingly concluded that in Volta's original experiment the disengagement of electricity is due to the chemical actions which result from the perspiration and from the oxygen of the atmosphere.

The development of electricity in chemical actions may be demonstrated in the following manner by means of the condensing electroscope (757). A disc of moistened paper is placed on the upper plate of the condenser, and on this a zinc capsule, in which some very dilute sulphuric acid is poured. A platinum wire, communicating with the ground, but insulated from the sides of the vessel, is immersed in the liquid, and at the same time the lower plate of the condenser is also connected with the ground by touching it with the moistened finger. On breaking contact and removing the upper plate, the gold leaves are found to be positively electrified, proving that the upper plate has received a charge of negative electricity.

By a variety of analogous experiments it may be shown that various chemical actions are accompanied by a disturbance of the electrical equilibrium; though of all chemical actions those between metals and liquids are the most productive of electricity. All the various resultant effects are in accordance with the general rule, that when a liquid acts chemically on a metal the liquid assumes the positive, and the metal the negative condition. In the above experiment the sulphuric acid, by its action on zinc becomes positively electrified, and its electricity passes off through the platinum wire into the ground, while the negative electricity excited on the zinc acts on the condenser just as an excited rod of sealing-wax would do.

In many cases the electrical indications accompanying chemical actions are but feeble, and require the use of a very delicate electroscope to render them apparent. Thus, one of the most energetic chemical actions, that of sulphuric acid upon zinc, gives no more free electricity than water alone does with zinc.

Opinion, which in this country at least, had, mainly by the influence of Faraday's experiments, tended in favour of the purely chemical origin of the electricity produced in voltaic action, has of late inclined more towards the contact theory. The following experiments, due to Sir W. Thomson, (*Papers on Electrostatics*, Macmillan & Co., p. 317) afford perhaps the most conclusive arguments hitherto adduced in favour of the latter view.

A very light metal bar was suspended by a fine wire so as to be movable about an axis, perpendicular to the plane of a ring made up of two halves, one of copper and the other of zinc. When the two halves of the ring were in contact, or were soldered together, the light bar turned from the copper to the zinc when it was negatively electrified, and from the zinc to the copper

when it was positively electrified, thus showing that the contact of the two metals causes them to assume different electrical conditions, the zinc taking the positive, and the copper the negative electricity. —

When however, the two halves instead of being in metallic contact were connected by a drop of water, no change was produced in the position of the bar by altering its electrification, provided it hung quite symmetrically relative to the two halves of the ring. This result shows that under the circumstances mentioned, no difference is produced in the electrical condition of the two metals. Hence the conclusion has been drawn by Sir W. Thomson and others, that the movement of electricity in the galvanic circuit is entirely due to the electrical difference produced at the surfaces of contact of the dissimilar metals.

There are, however, other facts which are not easily harmonised with this view; and indeed the last mentioned experiment can hardly be regarded as proving that in *all* cases two different metals connected by an electrolytic (791) liquid, assume the same electrical condition. It may, therefore, still be regarded as possible, or even probable, that the contact between the metals and the liquids of a cell contributes at least, in some cases, to the production of the current.

An instructive discussion of this question with some additional experimental evidence in favour of the chemical theory, will be found in a paper by Mr. J. A. Fleming published in the 'Proceedings of the Physical Society' (Taylor and Francis).

775. **Potential.**—It may be convenient to explain here what is meant by the term *potential*, which has of late come into extended use in speaking of electrical phenomena, to express the condition of an electrified body and of the space in its neighbourhood. It may be taken to represent what has been frequently called *tension*, though that word has been often used to express two different things.

Introduced originally into electrical science by Green, out of considerations arising from the mathematical treatment of the subject, the use of the term 'potential' is justified and recommended by the clearness with which it brings out the relations of electricity to work.

We have already seen, that in order to lift a certain mass against the attraction of gravitation (60-63) there must be a definite expenditure of work, and the equivalent of this work is met with in the energy which the lifted mass retains, or what is called the potential energy of position.

Let us now suppose that we have a large insulated metal sphere charged with positive electricity, and at a distance which is very great in comparison with the size of the sphere, a small insulated sphere charged with the same kind of electricity. If now we move the small sphere to any given point nearer the larger one, we must do a certain amount of work upon it to overcome the repulsion of the two electricities.

(The work required to be done against electrical forces, in order to move the unit of positive electricity from an infinite distance to a given point in the neighbourhood of an electrified conductor is called the *potential* at this point.)

If, in the above case, the larger sphere were charged with negative electricity, then instead of its being needful to do work in order to bring a unit of

positive electricity towards it, work would be done by electrical attraction, and the potential of the point near the charged sphere would thus be negative.

The potential at any point may also be said to be the work done against electrical force, in moving unit charge of negative electricity from that point.

The amount of work required to move the unit of positive electricity against electrical force, from any one position to any other, is equal to the excess of the electrical potential of the second position over the electrical potential of the first. This is, in effect, the same as what has been said above, for at an infinite distance the potential is zero.

We cannot speak of potential in the abstract, any more than we can speak of any particular height, without at least some tacit reference to a standard of level. Thus, if we say that such and such a place is 300 feet high, we usually imply that this height is measured in reference to the level of the sea.

So, too, we cannot speak of the potential of a mass of electricity without, at least, an implied reference to a standard of potential. This standard is usually the earth, which is taken as zero potential. If we speak of the potential at a given point, the difference between the potential at this point and the earth is referred to.

If in the imaginary experiment described above, we move the small sphere round the large electrified one always at the same distance, we shall do no work upon it for the purpose of overcoming or of yielding to electrical attractions or repulsions, just as if we move a body at a certain constant level above the earth's surface, we do no work upon it as respects gravitation. An imaginary surface drawn in the neighbourhood of an electrified body, such, that a given charge of electricity can be moved from any one point of it to any other, without any work being done either by or against electrical force is said to be an *equipotential surface*. Such a surface may be described as having everywhere the *same electrical level*; and the notion of bodies at different electrical levels in reference to a particular standard is the same as that of bodies at different potentials.

As water only flows from places at a higher to places at a lower level, so also electricity only passes from places at a higher to places at a lower potential. If an electrified body is placed in conducting communication with the earth, electricity will flow from the body to the earth, if the body is at a higher potential than the earth; and from the earth to the body, if the body is at a lower potential. If the potential of a body is higher than that of the earth it is said to have a positive potential; and if at a lower potential, a negative potential. A body charged with *free negative electricity* is one at a *lower* potential than the earth; one charged with *free positive electricity* is at a *higher* potential. The sense in which electrical potential is to be understood may be further illustrated by reference to heat. In the interchange of heat between bodies of different temperatures, the final result is that heat only passes from bodies at a higher to bodies at a lower temperature. Potential is, as regards electricity, what *temperature* is, as regards heat. We may have a small quantity of heat at a very high temperature. Thus a short thin platinum wire heated to incandescence has a far higher heat potential or temperature, than a cup full of warm water;



but the latter will have a far larger quantity. A flash of lightning represents electricity at a very high potential, but the quantity is small.

On an insulated sphere charged with electricity, the potential as well as the electrical density (716), are everywhere the same. On an ellipsoid, on the other hand, the density is different in different parts, while the potential is everywhere the same. That is to say, that if a small insulated test sphere were applied to various parts of the ellipsoid, and each time brought in contact with the fixed ball of the torsion balance, a different degree of repulsion would be shown each time. If, however, the small sphere were placed at a sufficient distance from the ellipsoid, and were connected by it with a thin wire, then, wherever the wire touched the ellipsoid, the proof sphere when afterwards applied to the torsion balance would in all cases produce the same repulsion.

The relation between electrical potential and density may be further illustrated by reference to the head of water in a reservoir. The pressure is proportional to the depth; the potential is everywhere the same. For suppose we want to introduce an additional pound of water into the reservoir, the same amount of work is required whether the water be forced in at the bottom or be poured in at the top.

If a hole be made very near the top of the reservoir, a quantity of water in falling to the ground would generate an amount of heat proportional to the fall. If the same quantity escaped through a hole near the bottom, it would not produce so much heat by direct fall; but it will possess a certain horizontal velocity, the destruction of which will produce a quantity of heat, which, added to that produced by the fall, will give exactly as much as the other.

776. **Current electricity.**—When a plate of zinc and a plate of copper are partially immersed in dilute sulphuric acid, no electrical or chemical change is apparent beyond perhaps a slight disengagement of hydrogen from the surface of the zinc plate. If now the plates are placed in direct contact, or, more conveniently, are connected by a metal wire, the chemical action sets in, a large quantity of hydrogen is disengaged, but this hydrogen is no longer disengaged at the surface of the zinc, but at the surface of the copper plate. Here then we have to deal with something more than mere chemical action, for chemical action would be unable to explain either the increase in the quantity of hydrogen disengaged when the metals touch, or the fact that this hydrogen is now given off at the surface of the copper plate. At the same time, if the wire



Fig. 630.

is examined it will be found to possess many remarkable thermal magnetic and other properties which will be afterwards described.

In order to understand what here takes place, let us suppose that we have two insulated metal spheres, and that one is charged with positive and the other with negative electricity, and that they are momentarily connected by means of a wire. Electricity will pass from a place of higher to a place of lower potential, that is, from the positive along the wire to the negative, and the potentials become equal. This is, indeed, nothing more than an elec-

trical discharge taking place through the wire; and during the infinitely short time in which this is accomplished, it can be shown that the wire exhibits certain heating and magnetising effects, of which the increase of temperature is perhaps the easiest to observe. If now we can imagine some agency by which the different electrical conditions of the two spheres are renewed as fast as they are discharged, which is what very nearly takes place when the two spheres are respectively connected with the two conductors  $r$  and  $r_1$ , of a Holtz's machine (figs. 581, 582), this equalisation of potentials, thus taking place, is virtually continuous, and the phenomena above mentioned are also continuous.

Now this is what takes place when the two metals are in contact in a liquid which acts upon them unequally. This is independent of hypothesis as to the cause of the phenomena; whether the electrical difference is only produced at the moment of contact of the metals, or whether it is due to the chemical action, or tendency to chemical action, between the metal and the liquid. The rapidly succeeding series of equalisations of potential which takes place in the wire being continuous, so long as the chemical action continues, is what is ordinarily spoken of as the *electrical current*.

If we represent by  $+e$  the potential of the copper plate, and by  $-e$  the potential of the zinc, then the electrical difference, that is the difference of potentials, is  $+e - (-e) = 2e$ . And this is general—the essential point of any such combination as the above is that it maintains, or tends to maintain, a difference of potentials, which difference is constant. If, for instance, the zinc plate be connected with the earth which is at zero potential, its potential also becomes zero; and since the electrical difference remains constant we have for the potential of the copper plate  $+2e$ . Similarly, if the copper be connected with the earth the potential of the zinc plate is negative and is  $-2e$ .

The conditions under which a current of electricity is formed in the above experiment may be further illustrated by reference to the conditions which determine the flow of water between two reservoirs containing water at different levels. If they are connected by a pipe, water will flow from the one at a higher level to the one at a lower level until the water in the two is at the same level in both, when of course the flow ceases. If we imagine the lower reservoir so large that any water added to it would not affect its level—if it were the sea for example—that would represent zero level, and if the higher reservoir could be kept at a constant level there would be a constant flow in the pipe.

We must here be careful not to dwell too much on this analogy. It is not to be supposed that in speaking of current of electricity we mean that any thing actually flows, that there is any actual transfer of matter. We say electricity flows or a current is produced, in much the same sense as that in which we say sound or light travels.

**777. Voltaic couple. Electromotive series.**—The arrangement just described, consisting of two metals in metallic contact, and a conducting liquid in which they are placed, constitutes a *simple voltaic element or couple*. So long as the metals are not in contact, the couple is said to be *open*, and when connected it is *closed*.

According to the chemical view to which we shall for the present

provisionally adhere, it is not necessary that, for the production of a current, one of the metals be unaffected by the liquid, but merely that the chemical action upon the one be greater than upon the other. For then we may assume that the current produced would be due to the difference between the differences of potential which each of the metals separately produces by its contact with the liquid. If the differences of potentials were absolutely equal—a condition, however, impossible of realisation with two distinct metals—we must assume that when the metals are joined no current would be produced. The metal which is most attacked is called the *positive* or *generating* plate, and that which is least attacked the *negative* or *collecting* plate. The positive metal determines the direction of the current, which proceeds *in* the liquid from the positive to the negative plate, and *out* of the liquid through the connecting wire from the negative to the positive plate.

In speaking of the *direction of the current* the direction of the positive electricity is always understood.

In the fundamental experiment, not only the connecting wire but also the liquid and the plates are traversed by the electrical currents—are the scene of electrical actions.

The mere immersion of two different metals in a liquid is not alone sufficient to produce a current, there must be chemical action. When a platinum and a gold plate are connected with a delicate galvanometer, and immersed in pure nitric acid, no current is produced; but on adding a drop of hydrochloric acid a strong current is excited, which proceeds in the liquid from the gold to the platinum, because the gold is attacked by the nitrohydrochloric acid, while the platinum is less so, if at all.

As a voltaic current is produced whenever two metals are placed in metallic contact in a liquid which acts more powerfully upon one than upon the other, there is a great choice in the mode of producing such currents. In reference to their electrical department, the metals have been arranged in what is called an *electromotive series*, in which the most *electropositive* are at one end, and the most *electronegative* at the other. Hence when any two of these are placed in contact in dilute acid, the current in the connecting wire proceeds from the one lower in the list to the one higher. The principal metals are as follows:—

- |            |             |              |
|------------|-------------|--------------|
| 1. Zinc    | 6. Nickel   | 11. Gold     |
| 2. Cadmium | 7. Bismuth  | 12. Platinum |
| 3. Tin     | 8. Antimony | 13. Graphite |
| 4. Lead    | 9. Copper   |              |
| 5. Iron    | 10. Silver  |              |

It will be seen that the electrical department of any metal depends on the metal with which it is associated. Iron, for example, in dilute sulphuric acid is electronegative towards zinc, but is electropositive towards copper; copper in turn is electronegative towards iron and zinc, but is electropositive towards silver, platinum, or graphite.

778. **Electromotive force.**—The force in virtue of which continuous electrical effects are produced throughout a circuit consisting of two metals in metallic contact in a liquid which acts unequally upon them, is usually called *the electromotive force*. Electromotive force and *difference of potentials* are

commonly used in the same sense. It is however more correct to regard difference of potentials as a particular case of electromotive force; for as we shall afterwards see, there are cases in which electrical currents are produced without the occurrence of that particular condition which we have called difference of potentials. The electromotive force is greater in proportion to the distance of the two metals from one another in the series. That is to say, it is greater the greater the difference between the chemical action upon the two metals immersed. Thus the electromotive force between zinc and platinum is greater than that between zinc and iron, or between zinc and copper. The law established by experiment is, that *the electromotive force between any two metals is equal to the sum of the electromotive forces between all the intervening metals.* Thus the electromotive force between zinc and platinum is equal to the sum of the electromotive forces between zinc and iron, iron and copper, and copper and platinum.

The electromotive force is influenced by the condition of the metal; rolled zinc, for instance, is negative towards cast zinc. It also depends on the degree of concentration of the liquid; in dilute nitric acid zinc is positive towards tin, and mercury positive towards lead; while in concentrated nitric acid the reverse is the case, mercury and zinc being respectively electro-negative towards lead and tin.

The nature of the liquid also influences the direction of the current: If two plates, one of copper and one of iron, are immersed in dilute sulphuric acid, a current is set up proceeding through the liquid from the iron to the copper; but if the plates, after being washed, are placed in solution of sulphide of potassium, a current is produced in the opposite direction—the copper is now the positive metal. Other examples may be drawn from the following table, which shows the electric department of the principal metals with three different liquids. It is arranged like the preceding one; each metal being electropositive towards any one lower in the list, and electro-negative towards any one higher.

Caustic potass	Hydrochloric acid	Sulphide of potassium
Zinc	Zinc	Zinc
Tin	Cadmium	Copper
Cadmium	Tin	Cadmium.
Antimony	Lead	Tin
Lead	Iron	Silver
Bismuth	Copper	Antimony
Iron	Bismuth	Lead
Copper	Nickel	Bismuth
Nickel	Silver	Nickel
Silver	Antimony	Iron.

A voltaic current may also be produced by means of two liquids and one metal. This may be shown by the following experiment: In a beaker containing strong nitric acid is placed a small porous cylinder closed at one end, and containing strong solution of caustic potass. If now two platinum wires connected with the two ends of a galvanometer (797) are immersed respectively in the alkali and in the acid, a voltaic current is produced, pro-

ceeding in the wire from the nitric acid to the potass, which thus correspond respectively to the negative and positive plates in ordinary couples.

A metal which is acted upon by a liquid can be protected from solution by placing in contact with it a more electropositive metal, and thus forming a simple voltaic circuit. This principle is the basis of Davy's proposal to protect the copper sheathing of ships, which are rapidly acted upon by sea water. If zinc or iron be connected with the copper, these metals are dissolved and the copper protected. Davy found that a piece of zinc the size of a nail was sufficient to protect a surface of forty or fifty square inches; unfortunately the proposal has not been of practical value, for the copper must be attacked to a certain extent to prevent the adherence of marine plants and shellfish.

779. **Poles and electrodes.**—If the wire connecting the two terminal plates of a voltaic couple be cut, it is clear, from what has been said about the origin and direction of the current, that positive electricity will tend to accumulate at the end of the wire attached to the copper or negative plate, and negative electricity on the wire attached to the zinc or positive plate. These terminals have been called the *poles* of the battery. For experimental purposes, more especially in the decomposition of salts, plates of platinum are attached to the ends of the wires.

Instead of the term poles the word *electrode* ( $\eta\lambda\epsilon\kappa\tau\rho\nu$  and  $\acute{o}\delta\acute{o}\varsigma$  a way) is now commonly used; for these are the *ways* through which the respective electricities emerge. It is important not to confound the positive *plate* with the positive *pole* or *electrode*. The positive electrode is that connected with the negative plate, while the negative electrode is connected with the positive plate.

780. **Voltaic pile. Voltaic battery.**—When a series of voltaic elements or pairs are arranged so that the zinc of one element is connected with the copper of another; the zinc of this with the copper of another, and so on, the arrangement is called a *voltaic battery*; and by its means the effects produced by a single element are capable of being very greatly increased.

The earliest of these arrangements was devised by Volta himself. It consists (fig. 631) of a series of discs piled one over the other in the following order: at the bottom, on a frame of wood, is a disc of copper, then a disc of cloth moistened by acidulated water, or by brine, then a disc of zinc; on this a disc of copper, and another disc of moistened cloth, to which again follow as many sets of zinc-cloth-copper, always in the same order, as may be convenient, the highest disc being of zinc. The discs are kept in vertical positions by glass rods.



Fig. 631.

It will be readily seen that we have here a series of simple voltaic couples, the moisture in the cloth acting as the liquid in the cases already mentioned, and that the

terminal zinc is the negative and the terminal copper the positive pole. From the mode of its arrangement, and from its discoverer, the apparatus is known as the *voltaic pile*, a term applied to all apparatus of this kind for accumulating the effects of dynamical electricity.

The distribution of electricity in the pile varies according as it is in connection with the ground by one of its extremities, or as it is insulated by being placed on a nonconducting cake of resin or glass.

In the former case, the end in contact with the ground is neutral, and the rest of the apparatus contains only one kind of electricity; this is negative if the copper disc, and positive if the zinc disc is in contact with the ground.

In the insulated pile the electricity is not uniformly distributed. By means of the proof-plane and the electroscope it may be demonstrated that the middle part is in a neutral state, and that one-half is charged with positive and the other with negative electricity, the potential increasing from the middle to the ends. The half terminated by a zinc disc is charged with negative electricity, and that by a copper with positive electricity. The pile is thus similar to a charged Leyden jar; with this difference, however, that when the jar has been discharged by connecting its two coatings, the electrical effects cease; while in the case of the pile, the cause which originally brought about the distribution of electricity restores this state of charge after the discharge; and the continuous succession of charges and discharges forms the current. The effects of the pile will be discussed in other places.

[781. **Wollaston's battery.**—The original form of the voltaic pile has a great many inconveniences, and possesses now only an historical interest.

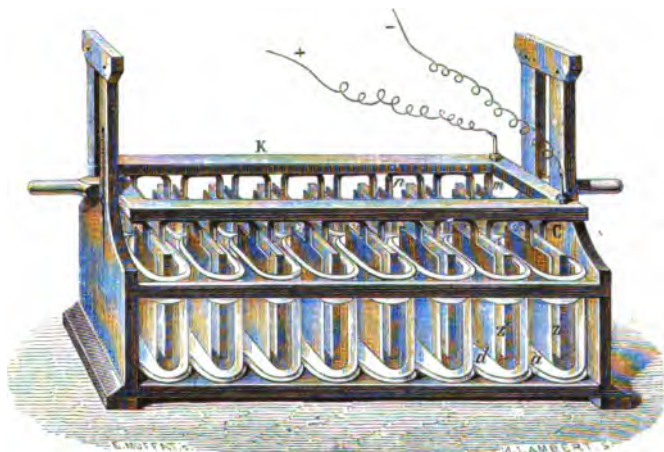

Fig. 632.

It has received a great many improvements, the principal object of which has been to facilitate manipulation, and to produce greater electromotive force.

One of the earliest of these modifications was the crown of cups, or *couronne des tasses*, invented by Volta himself; an improved form of this is known as *Wollaston's battery* (fig. 632); it is arranged so that when the current is not wanted, the action of the battery can be stopped.

The plates Z are of thick rolled zinc, and usually about eight inches in length by six in breadth. The copper plates, C, are of thin sheet, and bent so as to surround the zincs without touching them: contact being prevented by small pieces of cork. To each copper plate a narrow strip of copper, *o*, is soldered, which is bent twice at right angles and is soldered to the zinc plate; and the first zinc, Z, is surrounded by the first copper C; these two constitute a couple, and each couple is immersed in a glass vessel, containing acidulated water. The copper, C, is soldered to the second zinc by the strip *o*, and this zinc is in turn surrounded by a second copper, and so on.

Figure 632 represents a pile of sixteen couples united in two parallel series of eight each. All these couples are fixed to a cross frame of wood, by which they can be raised or lowered at pleasure. When the battery is not wanted, the couples are lifted out of the liquid. The water in these vessels is usually acidulated with  $\frac{1}{16}$  sulphuric and  $\frac{1}{20}$  of nitric acid.

*Hare's deflagrator*.—This is a simple voltaic arrangement, consisting of two large sheets of copper and zinc rolled together in a spiral, but preserved from direct contact by bands of leather or horsehair. The whole is immersed in a vessel containing acidulated water, and the two plates are connected outside the liquid by a conducting wire.

**782. Enfeeblement of the current in batteries. Secondary currents.** The various batteries already described, Volta's, Wollaston's, and Hare's which consist essentially of two metals and one liquid, labour under the objection that the currents produced rapidly diminish in strength.

This is principally due to three causes: the first is the decrease in the chemical action owing to the neutralisation of the sulphuric acid by its combination with the zinc. This is a necessary action, for upon it depends the current; it therefore occurs in all batteries, and is without remedy except by replacement of acid and zinc. The second is due to what is called *local action*; that is, the production of small closed circuits in the active metal, owing to the impurities it contains. These local currents rapidly wear away the active plate, without contributing anything to the continuance of the general current. They are remedied by amalgamating the zinc with mercury, by which chemical action is prevented until the circuit is closed, as will be more fully explained (792). The third arises from the production of an inverse electromotive force, which tends to produce a current in a contrary direction to the principal current, and therefore to destroy it either totally or partially. In the fundamental experiment (fig. 630), when the circuit is closed, sulphate of zinc is formed, which dissolves in the liquid, and at the same time a layer of hydrogen gas is gradually formed on the surface of the copper plate. This diminishes the activity of the combination in more than one way. In the first place, it interferes with the contact between the metal and the liquid; in the second place, in proportion as the copper becomes coated with hydrogen, we have virtually a plate of hydrogen instead of a plate of copper opposed to the zinc, and in addition, the hydrogen, by reacting on the sulphate of zinc which accumulates in the liquid, gradually causes

a deposition of zinc on the surface of the copper ; hence, instead of having two different metals unequally attacked, the two metals become gradually less different, and, consequently, the total effect, and the current, become weaker and weaker.

The *polarisation* of the plate (as this phenomenon is termed) may be destroyed by breaking the circuit and exposing the copper plate to the air ; the deposited hydrogen is thus more or less completely got rid of, and on again closing the circuit the current has nearly its original strength. The same result is obtained when the current of another battery is transmitted through the battery in a direction opposite to that of the first.

When platinum electrodes are used to decompose water, a similar phenomenon is produced, called *polarisation of the electrodes*, which may be illustrated by an arrangement represented in fig. 633, in which B is a constant

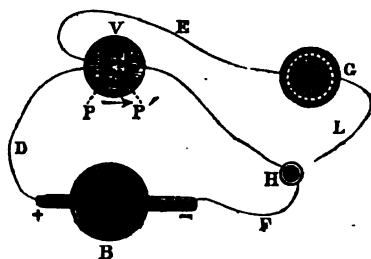

Fig. 633.

element, V a Voltmeter (820), G a galvanometer (797), and H a mercury cup. The wire L being disconnected from H, a current is produced in the voltmeter, the direction of which is from P to P' ; if now the wire F be detached from H, and L be connected therewith, a current is produced through the galvanometer the direction of which is from P' to P, that is, the opposite of that which the element had previously produced. Becquerel and Faraday have shown that this polarisation of the metals results from the deposits caused by the passage of the current.

#### CONSTANT CURRENTS.

783. **Constant currents.**—With few exceptions, batteries composed of elements with a single liquid have almost gone out of use, in consequence of the rapid enfeeblement of the current produced. They have been replaced by batteries with two liquids, which are called *constant batteries*, because their action continues without material alteration for a considerable period of time. The essential point to be attended to in securing a constant current is to prevent the polarisation of the inactive metal ; in other words, to hinder any permanent deposition of hydrogen on its surface. This is effected by placing the inactive metal in a liquid upon which the deposited hydrogen can act chemically.



784. **Daniell's battery.**—This was the first form of the constant battery, and was invented by Daniell in the year 1836.

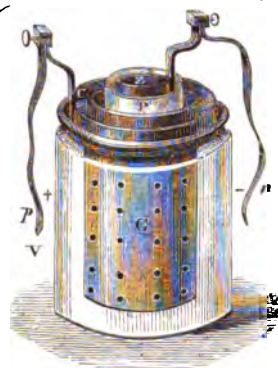

Fig. 634.

As regards the constancy of its action, it is perhaps still the best of all constant batteries. Fig. 634 represents a single element. A glass or porcelain vessel, V, contains a saturated solution of sulphate of copper, in which is immersed a copper cylinder, G, open at both ends, and perforated by holes. At the upper part of this cylinder there is an annular shelf, C, also perforated by small holes, and below the level of the solution; this is intended to support crystals of sulphate of copper to replace that decomposed as the electrical action proceeds. Inside the cylinder is a thin porous vessel, P, of unglazed earthenware. This contains either water or solution of common salt or dilute sulphuric acid,

in which is placed the cylinder of amalgamated zinc, Z. Two thin strips of copper, *p* and *n*, fixed by binding screws to the copper and to the zinc, serve for connecting the elements in series.

When a Daniell's element is closed, the hydrogen resulting from the action of the dilute acid on the zinc is liberated on the surface of the copper plate, but meets there the sulphate of copper, which is reduced, forming sulphuric acid and metallic copper, which is deposited on the surface of the copper plate. In this way sulphate of copper in solution is taken up, and if it were all consumed, hydrogen would be deposited on the copper, and the current would lose its constancy. This is prevented by the crystals of sulphate of copper which keep the solution saturated. The sulphuric acid produced by the decomposition of the sulphate permeates the porous cylinder, and tends to replace the acid used up by its action on the zinc; and as the quantity of sulphuric acid formed in the solution of sulphate of copper is regular, and proportional to the acid used in dissolving the zinc, the action of this acid on the zinc is regular also, and thus a constant current is produced.

In order to join together several of these elements to form a battery, the zinc of one is connected either by a copper wire or strip with the copper of the next, and so on, from one element to another, as shown in fig. 638, for another kind of battery.

Instead of a porous earthenware vessel a bag of sailcloth may be used for the diaphragm separating the two liquids. The effect is at first more powerful, but the two solutions mix more rapidly, which weakens the current. The object of the diaphragm is to allow the current to pass, but to prevent as much as possible the mixture of the two liquids.

The current produced by a Daniell's battery is constant for some hours; its action is stronger when it is placed in hot water.

785. **Grove's battery.**—In this battery the sulphate of copper solution is replaced by nitric acid, and the copper by platinum, by which greater electromotive force is obtained. Fig. 635 represents one of the forms of a couple of this battery. It consists of a glass vessel, A, partially filled with dilute

sulphuric acid (1 : 8); of a cylinder of zinc, Z, open at both ends; of a vessel V, made of porous earthenware, and containing ordinary nitric acid; of a plate of platinum, P (fig. 636), bent in the form of an S, and fixed to a cover, c, which rests on the porous vessel. The platinum is connected with a binding screw, b, and there is a similar binding screw on the zinc. In this battery the hydrogen, which would be disengaged on the platinum meeting the nitric acid, decomposes it, forming hyponitrous acid, which dissolves, or is disengaged as nitrous fumes. Grove's battery is the most convenient and one of the most powerful of the two-fluid batteries. It is, however, expensive, owing to the high price of platinum; besides which the platinum is liable, after some time, to become brittle and break very easily. But as the platinum is not consumed, it retains most of its value; and when the plates which have been used in a battery are heated to redness, they regain their elasticity.

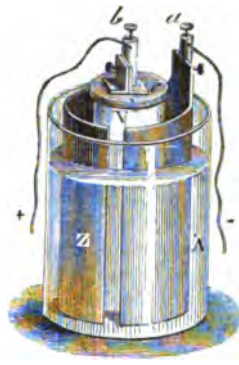

Fig. 635.

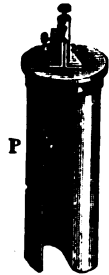

Fig. 636.

786. **Bunsen's battery.**—*Bunsen's battery*, also known as the *zinc carbon battery*, was invented in 1843; it is nothing more than Grove's battery, in which the plate of platinum is replaced by a cylinder of carbon. This is

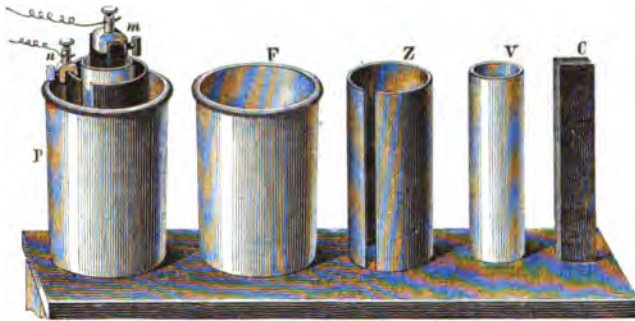

Fig. 637.

made either of the graphitoidal carbon deposited in gas retorts, or by calcining in an iron mould an intimate mixture of coke and bituminous coal, finely powdered and strongly compressed. Both these modifications of carbon are good conductors. Each element consists of the following parts: 1. a vessel, F (fig. 637), either of stoneware or of glass, containing dilute sulphuric acid; 2. a hollow cylinder, Z, of amalgamated zinc; 3. a porous vessel, V, in which is ordinary nitric acid; 4. a cylinder of carbon, C, prepared in the above manner. In the vessel F the zinc is first placed, and in it the carbon C in the porous vessel V as seen in P. To the carbon is fixed a binding screw, m, to

which a copper wire is attached, forming the positive pole. The zinc is provided with a similar binding screw, *n*, and wire, which is thus a negative pole.

The elements are arranged to form a battery (fig. 638) by connecting each carbon to the zinc of the following one by means of the clamps *mn*, and a strip of copper, *c*, represented in the top of the figure. The copper is pressed at one end between the carbon and the clamp, and at the other it is soldered to the clamp *n*, which is fitted on the zinc of the following element, and so forth. The clamp of the first carbon and that of the last zinc are alone provided with binding screws, to which are attached the wires.

The chemical action of Bunsen's battery is the same as that of Grove's, and being equally powerful, while less costly, is almost universally used on the Continent. But though its first cost is less than that of Grove's battery, it is more expensive to work, and is not so convenient to manipulate.)

*Callan's battery* is a modified form of Grove's. Instead of zinc and platinum, zinc and platinised lead are used, and instead of pure nitric acid Callan

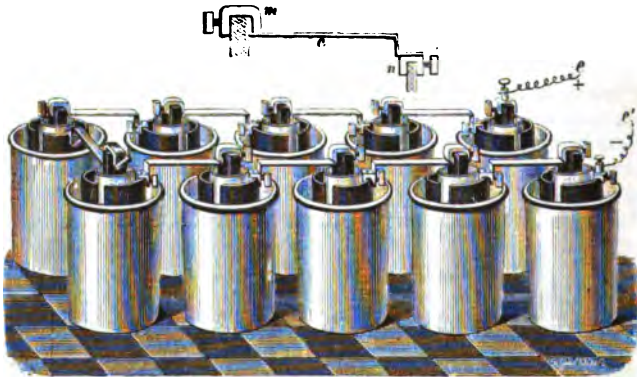

Fig. 638.

used a mixture of sulphuric acid, nitric acid, and saturated solution of nitre. The battery is said to be equal in its action to Grove's, and is much cheaper.

Callan has also constructed a battery in which zinc in dilute sulphuric acid forms the positive plate, and cast iron in strong nitric acid the negative. Under these circumstances the iron becomes passive: it is strongly electro-negative, and does not dissolve. If, however, the nitric acid becomes too weak, the iron is dissolved with simultaneous disengagement of nitrous fumes.

After being in use some time, all the batteries in which the polarisation is prevented by nitric acid disengage nitrous fumes in large quantities, and this is a serious objection to their use, especially in closed rooms. To prevent this, nitric acid is frequently replaced by chromic acid, or better, by a mixture of 4 parts bichromate of potassium, 4 parts sulphuric acid, and 18 water. The liberated hydrogen reduces the chromic acid to the state of oxide of chromium, which remains dissolved in sulphuric acid. With the same view, sesquichloride of iron is sometimes substituted for nitric acid; it becomes re-

duced to protochloride. But the action of the elements thus modified is considerably less than when nitric acid is used, owing to the increased resistance.

787. **Smee's battery.**—In this battery the polarisation of the negative plate is prevented by mechanical means. Each element consists of a sheet of platinum placed between two vertical plates of zinc, as in Grove's battery; but as there is only a single liquid, dilute sulphuric acid, the elements have much the form of those in Wollaston's battery. The adherence of hydrogen to the negative plate is prevented by covering the platinum with a deposit of finely divided platinum. In this manner the surface is roughened, which facilitates the disengagement of hydrogen to a remarkable extent, and, consequently, diminishes the resistance of the couple. Instead of platinum, silver covered with a deposit of finely divided platinum is frequently substituted, as being cheaper.

*Walker's battery.*—This resembles Smee's battery, but the electro-negative plate is either gas graphite or platinised graphite; it is excited by dilute sulphuric acid. This battery is used in all the stations of the South-Eastern Railway; it has considerable electromotive force, is convenient and economical in manipulation, and large-sized elements can be constructed at a cheap rate.

788. **Recent batteries.**—The *sulphate of mercury* battery (fig. 639) devised by M. Marié Davy, is essentially a zinc-carbon element, but of smaller

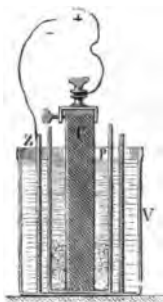

Fig. 639.

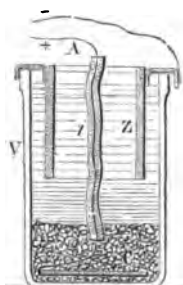

Fig. 640.

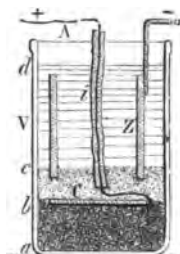

Fig. 641.

dimensions than those elements usually are. In the outer vessel, V, ordinary water or brine is placed, and in the porous vessel sulphate of mercury. This salt is agitated with about three times its volume of water, in which it is difficultly soluble, and the liquid poured off from the pasty mass. The carbon being placed in the porous vessel the spaces are filled with the residue and then the decanted liquid poured into it.

Chemical action takes place only when the cell is closed. The zinc then decomposes the water, liberating hydrogen, which traversing the porous vessel reduces the sulphate of mercury, forming metallic mercury, which collects at the bottom of the vessel, while the sulphuric acid formed at the same time traverses the diaphragm to act on the zinc and thus increases the action.

The mercury which is deposited may be used to prepare a quantity of sulphate equal to that which has been consumed. A small quantity of the solution of sulphate of mercury may also pass through the diaphragm; but this is rather advantageous, as its effect is to amalgamate the zinc.

The electromotive force of this element is about a quarter greater than that of Daniell's element, but it has greater resistance; it is rapidly exhausted when continuously worked, though it appears well suited for discontinuous work, as with the telegraph, and with alarums.

( *Gravity batteries.*—The use of porous vessels is liable to many objections, more especially in the case of Daniell's battery, in which they gradually become encrusted with copper, which destroys them. A kind of battery has been devised in which the porous vessel is entirely dispensed with, and the separation of the liquids is effected by the difference of density. Such batteries are called *gravity batteries*; the one in use at the telegraphic establishment of the Royal Engineers at Chatham is based on this principle.

Figure 640 represents a form devised by Callaud. V is a glass or earthenware vessel in which is a copper plate soldered to a wire insulated by gutta percha. On the plate is a layer of crystals of sulphate of copper, C; the whole is then filled with water, and the zinc cylinder, Z, is immersed in it. The lower part of the liquid becomes saturated with sulphate of copper; the action of the battery is that of a Daniell, and the sulphate of zinc which gradually forms floats on the solution of sulphate of copper owing to its lower density. This battery is easily manipulated, the consumption of sulphate of copper is economical, and when not agitated it works constantly for some months, provided care be taken to replace the water lost by evaporation.

*Minotto's battery.*—This may be described as a Daniell's element, in which the porous vessel is replaced by a layer of sawdust or of sand. At the bottom of an earthenware vessel (fig. 641) is placed a layer of coarsely-powdered sulphate of copper *a*, and on this a copper plate provided with an insulated copper wire *i*. On this there is a layer of sand or of sawdust *bc*, and then the whole is filled with water in which rests a zinc cylinder Z. The action is just that of a Daniell; the sawdust prevents the mixture of the liquids, but it also offers great resistance, which increases with its thickness.

From its simplicity and economy, and the facility with which it is constructed, this battery merits increased attention.

*De la Rue and Müller's element* consists of a glass tube about 6 inches long by 0.75 inch in diameter, closed by a vulcanised india-rubber stopper through which passes a zinc rod .18 inches in diameter and 5 inches long. A flattened silver wire also passes through the stopper to the bottom of the tube, in which is placed about half an ounce of silver chloride, the greater part of the cell being filled with solution of salammoniac. The hydrogen evolved at the negative plate reduces the chloride to metallic silver, which is thereby recovered. Since there is only one liquid, and the solid electrolyte is not acted upon when the circuit is open, the element is easily worked and requires little attention. It is very compact, 1,000 elements occupying a space of less than a cubic yard; De la Rue and Müller have used as many as 20,000 such cells in investigations on the stratification of the electric light.

Mr. Latimer Clark has devised an element, which consists of pure mercury as a negative plate covered with a paste, obtained by boiling sulphate of

mercury in a saturated solution of sulphate of zinc. The positive metal is a plate of zinc resting on this paste of sulphate. Insulated wires, leading to the mercury and the zinc respectively, form the connections. This battery is not well adapted for continuous work, but it furnishes a standard of electromotive force, which is constant and can be relied upon.

789. **Leclanché's element.**—This consists (fig. 642) of a rod of carbon, C, placed in a porous pot, which is then very tightly packed with a mixture of pyrolusite (peroxide of manganese) and gas coke M. This is covered over with a layer of pitch. At the top of the carbon is soldered a mass of lead, L, to which is affixed a binding screw. The positive plate is a rod of zinc Z, in which is fixed a copper wire, n. The exciting liquid consists of a strong solution of sal-ammoniac, contained in a glass vessel G, which is not more than one-third full. The electromotive force of the element is said to be about one-third greater than that of a Daniell's element; its internal resistance varies of course with the size, but is stated to be from two or three times that of a British Association unit. The battery is not adapted for continuous work as in heavy telegraphic circuits, or in electro-plating, as it soon becomes polarised; it has, however, the valuable property of quickly regaining its original strength when left at rest, and is extremely well adapted for discontinuous work.)

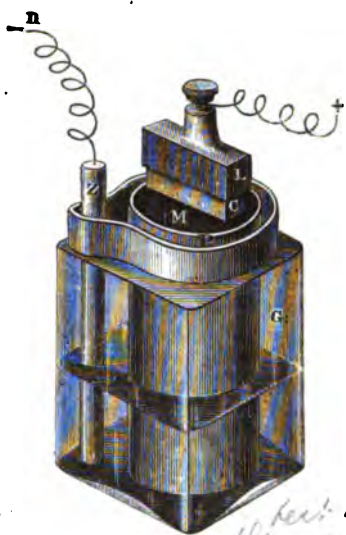

Fig. 642.

790. **Electromotive force of different elements.**—The following numbers represent the electromotive force of some of the elements most frequently used, compared with that of an ordinary Daniell's cell charged as above described; they are the means of many careful determinations:—

Daniell's element set up with water	1'00
"    "    "    pure zinc and pure water, with pure copper and pure saturated solution of sulphate of copper	1'02
Leclanché's    "    "    zinc in saturated solution of chloride of ammonium	1'32
Marié Davy's    "    "    "    "    "    "    "    "    "    "    "	1'41
Bunsen's    "    "    carbon in nitric acid	1'77
"    "    "    carbon in chromic acid	1'87
Grove's    "    "    platinum in nitric acid	1'82

The greatest electromotive force as yet observed, is by Beetz in a couple consisting of potassium amalgam in caustic potash, combined with pyrolusite in a solution of potassium permanganate. It is three times as much as a Daniell's element.

The standard of electromotive forces on the C. G. S. system is the *Volt*. This is equal to 1,000,000,000 or  $10^9$  absolute electromagnetic units; the latter way of expressing it is convenient, as avoiding the use of long numbers. The *volt* is rather less than the electromotive force of a Daniell's cell, the mean value of which may be taken at 1.12 volt.

791. **Comparison of the voltaic battery with a frictional electrical machine.**—Except in the case of batteries consisting of a very large number of couples, the difference of potentials between the terminals is far weaker than in frictional electrical machines, and is insufficient to give any visible spark. Gassiot's great battery, however, which consisted of 3,520 zinc and copper elements with poles  $\frac{1}{10}$  of an inch apart, gave a series of sparks across this interval which lasted for weeks.

In the case of a small battery or of a single cell, very delicate tests are required to detect any signs of electrification. But by means of a delicate condensing electroscope, and by extremely careful insulation, it can be shown that one pole possesses a positive and the other a negative charge.

For this purpose one of the plates of the electroscope is connected with one end of the pile, and the other with the other end or with the ground. The electroscope thus becomes charged, and on breaking the communication electroscopic indications are observed. A Leyden jar may even be charged when the inner coating is connected with one end of the pile, and the outer coating with the other; but this charge is far smaller than that furnished by an electrical machine.

On the other hand, the strength of current which a voltaic element can produce in a good conductor is much greater than that which can be produced by a machine. Faraday immersed two wires, one of zinc, and the other of platinum, each  $\frac{1}{13}$  of an inch in diameter, in acidulated water for  $\frac{5}{20}$  of a second. The effect thus produced on a magnetic needle in this short time was greater than that produced by 23 turns of the large electrical machine of the Royal Institution.

792. **Amalgamated zinc. Local currents.**—Perfectly pure distilled zinc is not attacked by dilute sulphuric acid, but becomes so when immersed in that liquid in contact with a plate of copper or of platinum. Ordinary commercial zinc, on the contrary, is rapidly dissolved by dilute acid. This, doubtless, arises from the impurity of the zinc, which always contains traces either of iron or lead. Being electro-negative towards zinc they tend to produce *local electrical currents*, which accelerate the chemical action without increasing the quantity of electricity in the connecting wire.

Zinc, when amalgamated, acquires the properties of perfectly pure zinc and is unaltered by dilute acid, so long as it is not in contact with a copper or platinum plate immersed in the same liquid. To amalgamate a zinc plate, it is first immersed in dilute sulphuric or hydrochloric acid so as to obtain a clean surface, and then a drop of mercury is placed on the plate and spread over it with a brush. The amalgamation takes place immediately, and the plate has the brilliant aspect of mercury.

Zinc as well as other metals are readily amalgamated by dipping them in an amalgam of one part sodium and 200 parts of mercury. Zinc plates may also be amalgamated by dipping them in a solution of mercury prepared by dissolving at a gentle heat one pound of mercury in five

pounds of aqua regia (one part of nitric to three of hydrochloric acid), and then adding five parts more of hydrochloric acid.

The amalgamation of the zinc removes from its surface all the impurities, especially the iron. The mercury effects a solution of pure zinc, which covers the surface of the plate, as with a liquid layer. The process was first applied to electrical batteries by Kemp. Amalgamated zinc is not attacked so long as the circuit is not closed, that is, when there is no current; when closed the current is more regular, and at the same time stronger, for the same quantity of metal dissolved.

793. **Dry piles.**—In *dry piles* the liquid is replaced by a solid hygrometric substance, such as paper or leather. They are of various kinds; in Zamboni's, which is most extensively used, the electromotors are tin or silver, and bin-oxide of manganese. To construct one of these a piece of paper silvered or tinned on one side is taken; the other side of the paper is coated with finely-powdered bin-oxide of manganese by slightly moistening it, and rubbing the powder on with a cork. Having placed together seven or eight of these sheets, they are cut by means of a punch into discs an inch in diameter. These discs are then arranged in the same order, so that the tin or silver of each disc is in contact with the manganese of the next. Having piled up 1,200 or 1,800 couples, they are placed in a glass tube, which is provided with a brass cap at each end. In each cap there is a rod and knob, by which the leaves can be pressed together, so as to produce better contact. The knob in contact with the manganese corresponds to the positive pole, while that at the other end, which is in contact with the silver or tin, is the negative pole.

Dry piles are remarkable for the permanence of their action, which may continue for several years. Their action depends greatly on the temperature and on the hygrometric state of the air. It is stronger in summer than in winter, and the action of a strong heat revives it when it appears extinct. A Zamboni's pile of 2,000 couples gives neither shock nor spark, but can charge a Leyden jar and other condensers. A certain time is however necessary, for electricity only moves slowly in the interior.

794. **Bohnenberger's electroscope.**—Bohnenberger has constructed a dry-pile electroscope of great delicacy. It is a condensing electroscope (fig. 611), from the rod of which is suspended a single gold leaf. This is at an equal distance from the opposite poles of two dry piles placed vertically, inside the bell jar, on the plate of the apparatus. As soon as the gold leaf possesses any free electricity it is attracted by one of the poles and repelled by the other, and its electricity is obviously contrary to that of the pole towards which it moves.

## CHAPTER II.

### DETECTION AND MEASUREMENT OF VOLTAIC CURRENTS.

795. **Detection and measurement of voltaic currents.**—The remarkable phenomena of the voltaic battery may be classed under the heads physiological, chemical, mechanical, and physical effects; and these latter may be again subdivided into the thermal, luminous, and magnetic effects. For



ascertaining the existence and measuring the strength of voltaic currents, the magnetic effects are more suitable than any of the others, and, accordingly, the fundamental magnetic phenomena will be described here, and the description of the rest postponed to a special chapter on electro-magnetism.

796. **Oersted's experiment.**—Oersted published in 1819 a discovery which connected magnetism and electricity in a most intimate manner, and became, in the hands of Ampère and of Faraday, the source of a new branch of physics. The fact discovered by Oersted is the directive action which a fixed current exerts at a distance on a magnetic needle.

To make this experiment a copper wire is suspended horizontally in the direction of the magnetic meridian over a movable magnetic needle, as represented in fig. 643. So long as the wire is not traversed by a current the needle remains parallel to it, but as soon as the ends of the wire are respectively connected with the poles of a battery or of a single element, *the needle is deflected, and tends to take a position which is the more nearly at right angles to the magnetic meridian in proportion as the current is stronger.*

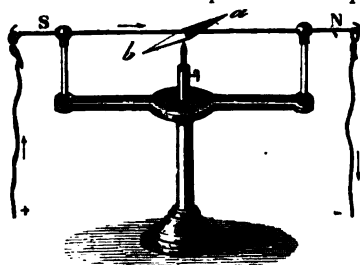

Fig. 643.

In reference to the direction in which the poles are deflected, there are several cases which may, however, be referred to a single principle. Remembering our assumption as to the direction of the current in the connecting wire (777) the preceding experiment presents the following four cases:—

i. If the current passes above the needle, and goes from south to north, the north pole of the magnet is deflected towards the west; this arrangement is represented in the above figure.

ii. If the current passes below the needle, also from south to north, the north pole is deflected towards the east.

iii. When the current passes above the needle, but from north to south, the north pole is deflected towards the east.

iv. Lastly, the deflection is towards the west when the current goes from north to south below the needle.

Ampère has given the following *memoria technica* by which all the various directions of the needle under the influence of a current may be remembered. If we imagine an observer placed in the connecting wire in such a manner that the current entering by his feet issues by his head, and that his face is always turned towards the needle, we shall see that in the above four positions the north pole is always deflected towards the left of the observer. By thus personifying the current, the different cases may be comprised in this general principle: *In the directive action of currents on magnets, the north pole is always deflected towards the left of the current.*

797. **Galvanometer or multiplier.**—The name *galvanometer*, or sometimes *multiplier* or *rheometer*, is given to a very delicate apparatus by which the existence, direction, and intensity of currents may be determined. It was invented by Schweigger in Germany a short time after Oersted's discovery.

In order to understand its principle, let us suppose a magnetic needle

suspended by a filament of silk (fig. 644), and surrounded in the plane of the magnetic meridian by a copper wire,  $mno\phi q$ , forming a complete circuit round the needle in the direction of its length. When this wire is traversed by a current, it follows, from what has been said in the previous paragraph,

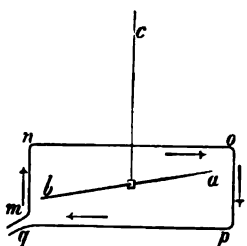

Fig. 644.

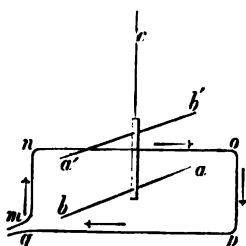

Fig. 645.

that in every part of the circuit an observer lying in the wire in the direction of the arrows, and looking at the needle  $ab$ , would have his left always turned towards the same point of the horizon, and consequently, that the action of the current in every part would tend to turn the north pole in the same direction: that is to say, that the actions of the four branches of the circuit concur to give the north pole the same direction. By coiling the copper wire in the direction of the needle, as represented in the figure, the action of the current has been *multiplied*. If instead of a single one, there are several circuits, provided they are insulated, the action becomes still more multiplied, and the deflection of the needle increases. Nevertheless, the action of the current cannot be multiplied indefinitely by increasing the number of windings, for, as we shall presently see, the intensity of a current diminishes as the length of the circuit is increased.

As the directive action of the earth continually tends to keep the needle in the magnetic meridian, and thus opposes the action of the current, the effect of the latter is increased by using an astatic system of two needles, as shown in fig. 645. The action of the earth on the needle is then very feeble, and, further, the actions of the current on the two needles become accumulated. In fact, the action of the circuit, from the direction of the current indicated by the arrows, tends to deflect the north pole of the lower needle towards the west. The upper needle  $a'b'$ , is subjected to the action of two contrary currents  $no$  and  $q\phi$ , but as the first is nearer, its action preponderates. Now this current passing below the needle, evidently tends to turn the pole  $a'$  towards the east, and, consequently, the pole  $b'$  towards the west: that is to say, in the same direction as the pole  $a$  of the other needle.

From these principles it will be easy to understand the theory of the *multiplier*. The apparatus represented in fig. 646 consists of a thick brass plate,  $D$ , resting on levelling screws; on this is a rotating plate,  $P$ , of the same metal, to which is fixed a copper frame, the breadth of which is almost equal to the length of the needles. On this is coiled a great number of turns of wire covered with silk. The two ends terminate in binding screws,  $i$  and  $o$ .

Above the frame is a graduated circle, C, with a central slit parallel to the direction in which the wire is coiled. The zero corresponds to the position of this slit, and there are two graduations on the scale, the one on the right and the other on the left of zero, but they only extend to  $90^\circ$ . By

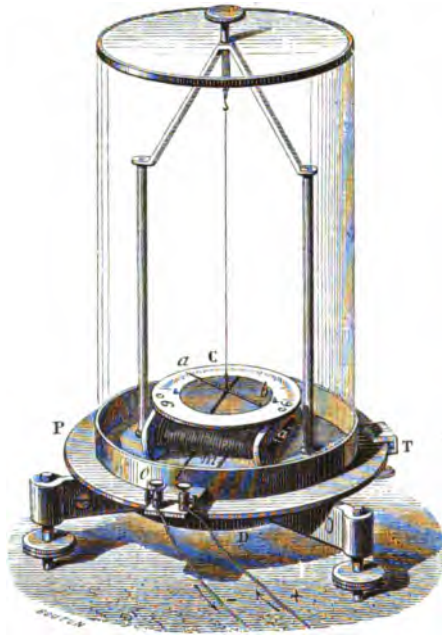

Fig. 646.

means of a very fine filament of silk, an astatic system is suspended; it consists of two needles,  $ab$  and  $a'b'$ , one above the scale, and the other within the circuit itself. These needles, which are joined together by a copper wire, like those in fig. 550 and fig. 645 and cannot move separately, must not have exactly the same magnetic intensity; for if they are exactly equal, every current, strong or weak, would always put them at right angles with itself.

In using this instrument, the diameter, to which corresponds the zero of the graduation, is brought into the magnetic meridian by turning the plate P until the end of the needle  $ab$  corresponds to zero. The instrument is fixed in this position by means of the screw clamp T.

The length and diameter of the wire vary with the purpose for which the galvanometer is intended. For one which is to be used in observing the currents due to chemical actions, a wire about  $\frac{1}{3}$  millimètre in diameter, and making about 800 turns, is well adapted. Those for thermo-electric currents, which have low intensity, require a thicker and shorter wire, for example, thirty turns of a wire  $\frac{1}{3}$  millimètre in diameter. For very delicate experi-

ments, as in physiological investigations, galvanometers with as many as 30,000 turns have been used.

By means of a delicate galvanometer consisting of 2,000 or 3,000 turns of fine wire, the coils of which are carefully insulated by means of silk and shellac, currents of high potential, as those of the electrical machine, may be shown. One end of the galvanometer is connected with the conductor and the other with the ground, and on working the machine the needle is deflected; affording thus an illustration of the identity of statical with dynamical electricity.

The deflection of the needle increases with the strength of the current; the relation between the two is, however, so complex, that it cannot well be deduced from theoretical considerations, but requires to be determined experimentally for each instrument. And in the majority of cases the instrument is used as a *galvanoscope* or *rheoscope*, that is, to ascertain rather the presence and direction of currents, than as a *galvanometer* or *rheometer* in the strict sense, that is, as a measurer of their intensity. The term *galvanometer* is, however, commonly used.

The *differential galvanometer* consists of a needle, as in an ordinary galvanometer, but round the frame of which are coiled two wires of the same kind and dimensions, carefully insulated from each other, and provided with suitable binding screws, so that separate currents can be passed through each of them. If the currents are of the same intensity but in different directions, no deflection is produced; where the needle is deflected one of the currents differs from the other. Hence the apparatus is used to ascertain a difference in intensity of two currents and to this circumstance owes its name.

798. **Sir W. Thomson's marine galvanometer.**—In laying submarine cables the want was felt of a galvanometer sufficiently sensitive to test insula-

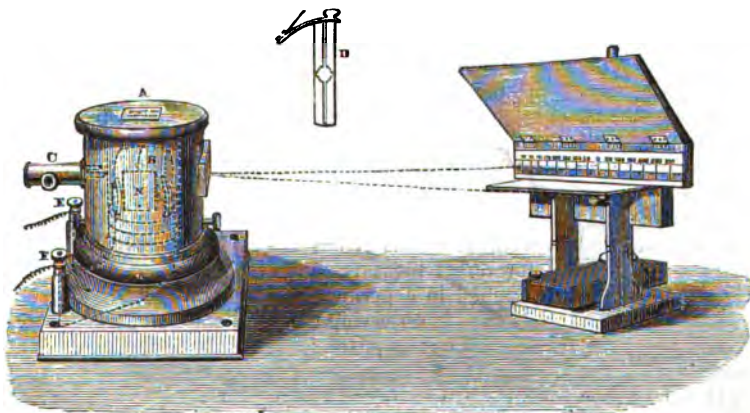

Fig. 647.

tion, which at the same time was not affected by the pitching and rolling of the ship. For this purpose, Sir W. Thomson invented his marine galvano-

meter. B (fig. 647) represents a coil of many thousand turns of the finest copper wire, carefully insulated throughout, terminating in the binding screws E E. In the centre of this coil is a slide, which carries the magnet, the arrangement of which is represented on a larger scale in D. The magnet itself is made of a piece of fine watch spring about  $\frac{3}{8}$  of an inch in length, and does not weigh more than a grain; it is attached to a small and very slightly concave mirror of very thin silvered glass. A single fibre of silk is stretched across the slide, and the mirror and magnet are attached to it in such a manner that the fibre exactly passes through the centre of gravity in every position. As the mirror and magnet weigh only a few grains, they retain their position respecting the instrument, however the ship may pitch and roll. The slide fits in a groove in the coil, and the whole is enclosed within a wrought-iron case with an aperture in front, and a wrought-iron lid on the top. The object of this is to counteract the influence of the terrestrial magnetism when the ship changes its course.

Underneath the coil is a large bent steel magnet N, which compensates the earth's directive action upon the magnet D, and in the side of the case, and on a level with D, a pair of magnets C, are placed with opposite poles together. By a screw, suitably adjusted, the poles of the magnets may be brought together; in which case they quite neutralise each other, and thus exert no action on the suspended magnet, or they may be slid apart from each other in such a manner that the action of either pole on D preponderates to any desired extent. This small magnet is thus capable of very delicate adjustment. The large magnet N, and the pair of magnets C, are analogous to the coarse and fine adjustment of a microscope.

At a distance of about three feet, there is a scale with the zero in the centre and the graduation extending on each side. Underneath this zero point is a narrow slit, through which passes the light of a paraffine lamp, and which traversing the window is reflected from the curved mirror against the graduated scale. By means of the adjusting magnets the image of the slit is made to fall on the centre of the graduation.

This being the case, if any arrangement for producing a current, however weak, be connected with the terminals, the spot of light is deflected either to one side or the other, according to the direction of the current; the stronger the current the greater the deflection of the spot; and if the current remains of constant strength for any length of time, the spot is stationary in a corresponding position.

The movement on a screen, of a spot of light reflected from a body, is the most delicate and convenient means of observing motions which of themselves are too small for direct measurement or observation. Hence this principle is frequently applied in experimental investigations and in lecture illustrations (508). It is used in observing the motion of oscillating bodies, in measuring the variations of magnetism, in determining the expansion of solids, &c.

It will be seen from the article on the Electric Telegraph, how alternate deflections of the spot of light may be utilised in forming a code of signals.

799. **Tangent compass, or tangent galvanometer.**—When a magnetic needle is suspended in the centre of a voltaic current in the plane of the magnetic meridian, it can be proved that the intensity of a current is directly

proportional to the tangent of the angle of deflection, provided the dimensions of the needle are sufficiently small as compared with the diameter of the circuit. An instrument based on this principle is called the *tangent galvanometer* or *tangent compass*. It consists of a copper ring, 12 inches in

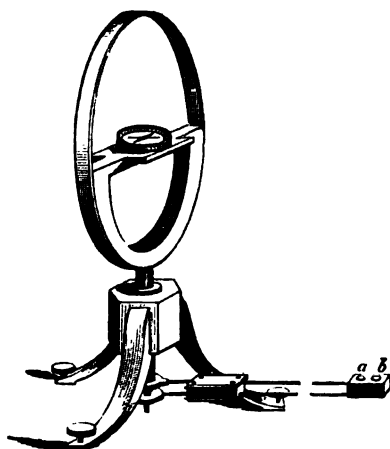

Fig. 648.

diameter, and about an inch in breadth, mounted vertically on a stand; the lower half of the ring is generally fitted in a semicircular frame of wood to keep it steady. In the centre of the ring is suspended a delicate magnetic needle, whose length must not exceed  $\frac{1}{12}$  or  $\frac{1}{10}$  of the diameter of the circle. Underneath the needle there is a graduated circle. The ends of the ring are prolonged in copper wires, fitted with mercury cups, *ab*, by which it can be connected with a battery or element. The circle is placed in the plane of the magnetic meridian, and the deflection of the needle is directly read off on the circle, and its corresponding value obtained from a table of tangents.

On account of its small resistance, the tangent galvanometer is well adapted for currents of low tension, but in which a considerable quantity of electricity is set in motion. For currents which can overcome great resistance, but have only a small quantity of electricity, the multiplier is best fitted.

To prove that the intensities of various currents are proportional to the tangents of the corresponding angles of deflection, let *NS*, fig. 649, represent the wire of the galvanometer and *ns* the needle, and let  $\phi$  be the angle of deflection produced when a current *C* is passed. Two forces now act upon the needle—the force of the earth's magnetism, which we will denote by *H*, which tends to place the needle in the magnetic meridian, and the strength of the current *C*, which strives to place it at right angles to the magnetic meridian. Let the magnitudes of these forces be represented by the corresponding lines *an* and *bn*. Now the whole intensities of these forces do not act so as to

turn the point of the needle round, but only those components which are at right angles to the needle. Resolving them, we have  $ng$  and  $nf$  as the forces acting in opposite directions on the needle; and since the needle is at rest these forces must be equal.

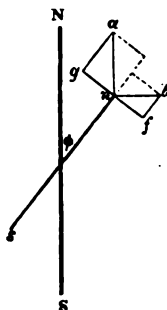

Fig. 649.

The angle  $nag$  is equal to the angle  $\phi$ , and therefore  $ng = an \sin \phi$ ; and in like manner the angle  $bnf$  is equal to  $\phi$  and  $nf = bn \cos \phi$ ; and therefore since  $nf = ng$ ,  $bn \cos \phi = an \sin \phi$ , or  $bn = an \frac{\sin \phi}{\cos \phi} = an \tan \phi$ , that is,  $C = H \tan \phi$ .

If any other current be passed through the galvanometer we shall have similarly  $C' = H \tan \phi'$ ; and since the earth's magnetism does not alter in one and the same place  $C : C' = \tan \phi : \tan \phi'$ .

In this reasoning it has been assumed that the action of the current on the needle is the same whatever be the angle by which it is deflected. This is only the case when the dimensions of the needle are small compared with the diameter of the ring; it should not be more than  $\frac{1}{8}$  or  $\frac{1}{10}$  the diameter. In order to measure with accuracy the deflection a light index is placed at right angles to the needle.

*Wiedemann's* tangent galvanometer consists of a short thick copper tube, in which is suspended, instead of a needle, a thick magnetised sheet mirror,



Fig. 650.

the position of which can be observed by a telescope and scale (560). On each side of the copper tube, and sliding in grooves, are coils of wire which can be

pushed over the tube. By this lateral arrangement of the current in reference to the magnetic needle, the error of the tangent galvanometer is diminished; for when the needle is deflected one end moves away from the current, while the other approaches it. According to Gaugain, the tangent of the angle of deflection is most nearly proportional to the strength of the current, when the centre of the needle is at a distance of one quarter the diameter of the ring from the centre of the ring.

**800. Sine galvanometer.**—This is another form of galvanometer for measuring powerful currents. Round the circular frame, M, fig. 650, several turns of stout insulated copper wire are coiled, the two ends of which,  $i$ , terminate in the binding screws at E. On a table in the centre of the ring there is a magnetic needle,  $m$ ; a second light needle,  $n$ , fixed to the first, serves as pointer along the graduated circle, N. Two copper wires,  $a, b$ , from the sources of electricity to be measured, are connected with E. The circles M and N are supported on a foot O, which can move about a vertical axis passing through the centre of a fixed horizontal circle H.

The circle M being then placed in the magnetic meridian, and therefore in the same plane as the needle, the current is allowed to pass. The needles being deflected, the circuit M is turned until it coincides with the vertical plane passing through the magnetic needle  $m$ . The directive action of the current is now exerted perpendicularly to the direction of the magnetic needle, and it may be shown that the strength of the current is proportional to the sine of the angle of deflection; this angle is measured on the circle H by means of a vernier on the piece C. This piece, C, fixed to the foot O, turns it by means of a knob, A. The angle of deflection, and hence its sine, being known, the intensity of the current may be thus deduced: let  $mm'$  be the direction of the magnetic meridian,  $d$  the angle of deflection, C the strength of the current, and H the directive action of the earth. If the direction and intensity of this latter force be represented by  $ak$ , it may be replaced by two components,  $ah$  and  $ac$ , fig. 651. Now, as the first has no directive action on the needle, the component  $ac$  must alone counterpoise the force C, that is,  $C = ac$ . But in the triangle,  $ack$ ,  $ac = ak \cos cak$ , from which  $ac = H \sin d$ , for the angle  $cak$  is the complement of the angle  $d$ , and  $ak$  is equal to H; hence, lastly,  $C = H \sin d$ , which was to be proved. In like manner for any other current  $C'$  which produces a deflection  $d'$ , we shall have  $C' = H \sin d'$ , whence  $C : C' = \sin d : \sin d'$ .

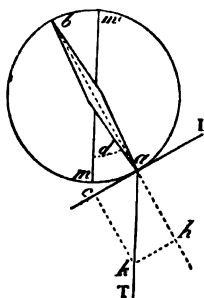

Fig. 651.

§ 801. **Ohm's law.**—For a knowledge of the conditions which regulate the action of the voltaic current, science is indebted to the late Professor Ohm. His results were at first deduced from theoretical considerations; but by his own researches, as well as by those of Fechner, Pouillet, Daniell, De la Rive, Wheatstone, and others, they have received the fullest confirmation, and their great theoretical and practical importance has been fully established.

i. The force or cause by which electricity is set in motion in the voltaic circuit is called the *electromotive force*. The quantity of electricity which in any unit of time flows through a section of the circuit is called the *intensity*,



or perhaps better *the strength of the current*. Ohm found that this strength is the same in all parts of one and the same circuit, however heterogeneous they were; and also that it is proportional to the electromotive force.

It has further been found that when the same current is passed respectively through a short and through a long wire of the same material, its action on the magnetic needle is less in the latter case than in the former. Ohm accordingly supposed that in the latter case there was a greater *resistance* to the passage of the current than in the former; and he proved that '*the resistance is inversely proportional to the strength of the current.*'

On these principles Ohm founded the celebrated law which bears his name, that—

*The strength of the current is equal to the electromotive force divided by the resistance.*

Which is expressed by the simple formula

$$C = \frac{E}{R},$$

where C is the strength of the current, E the electromotive force, and R the resistance.

ii. The resistance of a conductor depends on three elements; its *conductivity*, which is a constant, determined for each conductor; its *section*; and its *length*. The resistance is obviously inversely proportional to the conductivity, that is, the less the conducting power the greater the resistance. This has been experimentally shown, and it has also been proved that *the resistance is inversely as the section, and directly as the length of a conductor*. If then  $\kappa$  is the conductivity,  $\omega$  the section, and  $\lambda$  the length of a conductor, we have

$$R = \frac{\lambda}{\kappa\omega} \quad \text{and} \quad C = \frac{E}{\frac{\lambda}{\kappa\omega}} = \frac{\kappa\omega E}{\lambda},$$

that is, *the strength of a current is inversely proportional to the length of the conductor and directly proportional to its section and conductivity*.

iii. In a voltaic battery composed of different elements, the strength of the current is equal to the sum of the electromotive forces of all the elements divided by the sum of the resistances. Usually, however, a battery is composed of elements of the same kind, each having the same electromotive force and the same resistance.

In an ordinary element there are essentially two resistances to be considered: 1. That offered by the liquid conductor between the two plates, which is frequently called the *internal or essential resistance*; and, 2. That offered by the interpolar conductor which connects the two plates outside the liquid; this conductor may consist either wholly of metal, or may be partly of metal and partly of liquids to be decomposed: it is the *external or non-essential resistance*. Calling the former R and the latter r, Ohm's formula becomes

$$C = \frac{E}{R+r}.$$

iv. If any number, n, of similar elements are joined together, there is n times the electromotive force, but at the same time n times the internal re-

sistance, and the formula becomes  $\frac{nE}{nR+r}$ . If the resistance in the inter-polar,  $r$ , is very small, which is the case, for instance, when it is a short thick copper wire, it may be neglected in comparison with the internal resistance, and then we have

$$C = \frac{nE}{nR} = \frac{E}{R};$$

that is, a battery consisting of several elements produces in this case no greater effect than a single element.

v. If, however, the external resistance is very great, as when the current has to produce the electric light, or to work a long telegraphic circuit, advantage is gained by using a larger number of elements; for then we have the formula

$$C = \frac{nE}{nR+r};$$

if  $r$  is very great as compared with  $nR$ , the latter may be neglected, and the expression becomes

$$C = \frac{nE}{r};$$

that is, that the strength within certain limits is proportional to the number of elements.

In a thermo-electric pile, which consists of very short metallic conductors, the internal resistance  $R$  is so small that it may be neglected, and the strength is inversely as the length of the connecting wire.

vi. If the plates of an element be made  $m$  times as large, there is no increase in the electromotive force, for this depends on the nature of the metals and of the liquid (778), but the resistance is  $m$  times as small, for the section is  $m$  times larger; the expression becomes then

$$C = \frac{E}{R+r} = \frac{mE}{R+mr}.$$

Hence, an increase in the size of the plate, or, what is the same thing, a decrease in the internal resistance, does not increase the strength to an indefinite extent; for ultimately the resistance of the element  $R$  vanishes in comparison with the resistance  $r$ , and the strength always approximates to the value  $C = \frac{E}{r}$ .

vii. Ohm's law enables us to arrange a battery so as to obtain the greatest effect in any given case. For instance, with a battery of six elements there are the following four ways of arranging them: 1. In a single series (fig. 652), in which the zinc  $Z$  of one element is united with the copper  $C$  of the second, the zinc of this with the copper of the third, and so on; 2. Arranged in a system of three double elements, each element being formed by joining two of the former (fig. 653); 3. In a system of two elements, each of which consists of three of the original elements joined, so as to form one of triple the surface (fig. 654); lastly, of one large element, all the zincs and all the coppers being joined, so as to form a pair of six times the surface (fig. 655).

With a series of twelve elements there may be six different combinations, and so on for a larger number.

Now let us suppose that in the particular case of a battery of six elements the internal resistance  $R$  of each element is 3, and the external resistance



Fig. 652.

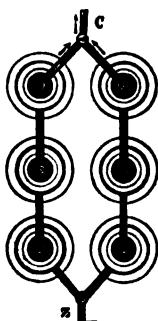

Fig. 653.

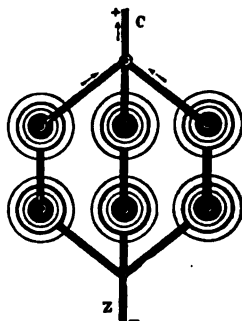

Fig. 654.

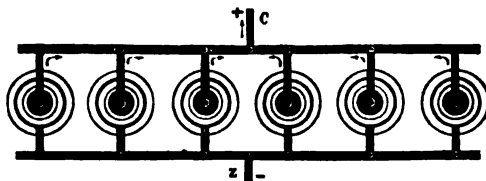

Fig. 655.

$r = 12$ . Then, in the first case, where there are six elements, arranged in series, we have the value,

$$C = \frac{6E}{6R + r} = \frac{6E}{6 \times 3 + 12} = \frac{6E}{30}$$

If they were united so as to form three elements, each of double the surface, as in the second case (fig. 653), the electromotive force would then be the electromotive force in each element; there would also be a resistance  $R$  in each element, but this would only be half as great, for the section of the plate is now double; hence the strength in this case would be

$$C' = \frac{3E}{\frac{3R}{2} + r} = \frac{3E}{\frac{9}{2} + 12} = \frac{6E}{33}$$

accordingly this change would lessen the strength.

If, with the same elements, the resistance in the connecting wire were only  $r = 2$ , we should have the values in the two cases respectively—

$$C = \frac{6 \times E}{6 \times 3 + 2} = \frac{6E}{20},$$

and  $C' = \frac{3E}{\frac{3R}{2} + r} = \frac{6E}{9 + 4} = \frac{6E}{13}.$

The result in the latter case is, therefore, more favourable. If the resistance  $r$  were 9, the strength would be the same in both cases. Hence, then altering the size of the plates or their arrangement, favourable or unfavourable results are obtained according to the relation between  $R$  and  $r$ .

✓802. **Arrangement of multiple battery for maximum current.**—It can be shown that *in any given combination the maximum effect is obtained when the total resistance in the elements is equal to the resistance of the interpolar.* For let  $N$  be the total number of cells available for a given combination, and let  $n$  be the number of cells arranged *tandem*, or in series, that is, when the zinc of one is connected with the copper of the next, and so on; then there will be  $\frac{N}{n}$  elements arranged abreast. If  $e$  be the electromotive force, and  $r$  the resistance of one cell, and  $l$  is the external resistance, then the strength of the current will be

$$C = \frac{\frac{ne}{nr + l}}{\frac{N}{n}} = \frac{nNe}{n^2r + Nl} = \frac{ne}{n^2r + l}.$$

If this combination be such that the total internal resistance  $\frac{n^2}{N}r$  is equal to the external resistance  $l$ , we have

$$C = \frac{ne}{2l}.$$

For suppose that the whole number of cells is arranged so as to form another combination of cells tandem, let  $n'$  be this number, which shall be equal to  $n \pm \nu$ ; then we have

$$C' = \frac{(n \pm \nu) Ne}{(n \pm \nu)^2 r + Nl} = \frac{(n \pm \nu) Ne}{n^2r + \nu r^2 \pm 2n\nu r + Nl},$$

or since  $n^2r = Nl = \frac{(n \pm \nu) Ne}{2(Nl \pm n\nu r) + \nu^2 r}.$

Now the value of  $C - C_1$  is always positive; for reducing to a common denominator—

$$C = \frac{2 Nle (n \pm \nu) + \nu^2 r n e}{\text{common denominator}}; \quad C_1 = \frac{2 Nle (n \pm \nu)}{\text{common denominator}}.$$

Hence the best effect is obtained when  $n = \sqrt{\frac{Nl}{r}}.$

If in a given case we have 8 elements, each offering a resistance 15, and an interpolar with the resistance 40, we get  $n = 4.3$ . But this is an im-

possible arrangement, for it is not a whole number, and the nearest whole number must be taken. This is 4, and it will be found on making a calculation analogous to that above, that when arranged so as to form 4 elements, each of double surface, the greatest effect is obtained.

---

### CHAPTER III.

#### EFFECTS OF THE CURRENT.

803. **Physiological actions.**—Under this name are included the effects produced by a battery-current on living organisms or tissues.

When the electrodes of a strong battery are held in the two hands a violent shock is felt, especially if the hands are moistened with acidulated water, which increases the conductivity. The violence of the shock increases with the number of elements used, and with a large number—as 200 Bunsen's cells—is even dangerous.

The power of contracting upon the application of a voltaic current seems to be a very general property of *protoplasm*—the physical basis of both animal and vegetable life ; if, for example, a current of moderate strength be passed through such a simple form of protoplasm as an *Amœba*, it immediately withdraws its processes, ceases its changes of form, and contracts into a rounded ball—soon, however, resuming its activity upon the cessation of the current. Essentially similar effects of the current have been observed in the protoplasm of young vegetable cells.

If a frog's fresh muscle (which will retain its vitality for a considerable time after removal from the body of the animal) be introduced into a galvanic circuit, no apparent effect will be observed during the steady passage of the current, but every opening or closure of the circuit will cause a muscular contraction, as will also any sudden and considerable alteration in its intensity. By very rapidly interrupting the current, the muscle can be thrown into a state of uninterrupted contraction, or physiological *tetanus*, each new contraction occurring before the previous one has passed off. Other things being equal, the amount of shortening exhibited by the muscle increases, up to a certain limit, with the intensity of the current. These phenomena entirely disappear with the life of the muscle ; hence the experiments are somewhat more difficult with warm-blooded animals, the vitality of whose muscles, after exposure or removal from the body, is maintained with more difficulty ; but the results of careful experiment are exactly the same here as in the case of the frog.

The influence of an electric current upon living nerves is very remarkable ; as a general rule, it may be stated that its effect is to throw the nerve into a state of activity, whatever its special function may be ; thus, if the nerve be one going to a muscle, the latter will be caused to contract ; if it be one of common sensation, pain will be produced ; if one of special sense, the sensation of a flash of light, or of a taste, etc., will be produced, according to the nerve irritated. These effects do not manifest themselves during

the even passage of the current, but only when the circuit is either opened or closed or both. Of course, the continuity of the nerve with the organ where its activity manifests itself must be maintained intact. The changes set up by the current in the different nerve trunks are probably similar, the various sensations, etc., produced depending on the different terminal organs with which the nerves are connected.

Sanderson has ascertained that the movement which causes the *Dionæa muscipula* (Venus' Fly-trap), one of what are called carnivorous plants, to close its hairy leaves and thereby entrap insects which alight upon it, is accompanied by an electrical current in a manner analogous to that manifested in muscular contraction. The manner in which the irritation is caused seems immaterial.

804. **Electrotonus.**—In a living nerve, as will be stated more fully in Chapter X., certain parts of the surface are electropositive to certain other parts, so that if a pair of electrodes connected with a galvanometer be applied to these two points, a current will be indicated; if now another part of the nerve be interposed in a galvanic circuit, it will be found that, if this extraneous current be passing in the same direction as the proper nerve current, the latter is increased, and *vice versa*; and this, although it has previously been demonstrated experimentally that none of the battery current escapes down the nerve, so as to exert any influence of its own on the galvanometer. This alteration of its natural electromotive condition, produced through the whole of a nerve by the passage of a constant current through part of it, is known as the *electrotonic state*; it is most intense near the extraneous, or, as it is called, the *exciting current*. It continues as long as the latter is passing, and is attended with important changes in the *excitability* of the nerve, or, in other words, the readiness with which the nerve is thrown into a state of functional activity by any stimulus applied to it. Pflüger, who has investigated these changes, has named the part of the nerve through which the exciting current is passing the *intrapolar region*; the condition of the nerve close to the positive pole is called *anelectrotonus*; that near the negative pole, *kathelectrotonus*. The excitability of the nerve is diminished in the anelectrotonic region, so that with a motor nerve, for example, a stronger stimulus than before would need to be applied at this part, in order to obtain a muscular contraction; in the kathelectrotonic region, on the contrary, the excitability of the nerve is heightened. Moreover, with an exciting current of moderate strength the power of the nerve to conduct a stimulus is lowered in the anelectrotonic region, and increased in the kathelectrotonic; with strong currents it is said to be diminished in both.

These facts have to be taken into account in the scientific application of galvanism to medical purposes; if, for instance, it is wished to diminish the excitability of the sensory nerves of any part of the body, the current should be passed in such a direction as to throw the nerves of that part into a state of anelectrotonus—and similarly in other cases.

If a powerful electric current be passed through the body of a recently killed animal, violent movements are produced, as the muscles ordinarily retain their vitality for a considerable time after general systematic death; by this means, also, life has been re-established in animals which were appa-

rently dead—a properly applied current stimulating the respiratory muscles to contract.

805. **Heating effects.**—When a voltaic current is passed through a metal wire the same effects are produced as by the discharge of an electric battery (765); the wire becomes heated, and even incandescent if it is very short and thin. With a powerful battery all metals are melted, even iridium and platinum, the least fusible of metals. Carbon is the only element which has no

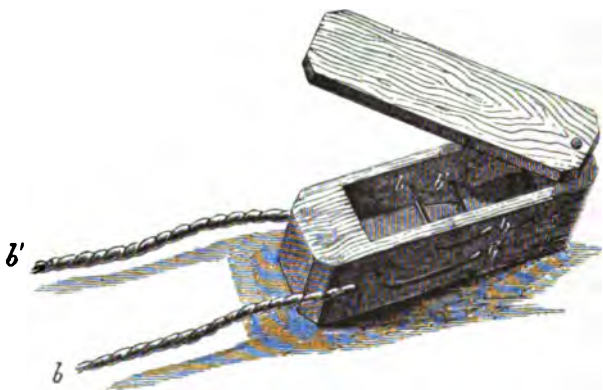

Fig. 656.

hitherto been fused by it. Despretz, however, with a battery composed of 600 Bunsen's elements joined in six series (801), has raised rods of very pure carbon to such a temperature that they were softened and could be welded together, indicating an incipient fusion.

A battery of 30 to 40 Bunsen's elements is sufficient to melt and volatilise fine wires of lead, tin, zinc, copper, gold, silver, iron, and even platinum, with differently coloured sparks. Iron and platinum burn with a brilliant white light; lead with a purple light; the light of tin and of gold is bluish white; the light of zinc is a mixture of white and gold; finally copper and silver give a green light.

The thermal effects of the voltaic current are used for firing mines for military purposes and for blasting operations. The following arrangement, devised by Colonel Schaw, is adopted in the English service. Fig. 656 represents a small wooden box provided with a lid. Two moderately stout copper wires, *b b*, insulated by being covered with gutta-percha, are deprived of this coating at the ends, which are then passed through and through the box in the manner represented in the figure. The distance between them is  $\frac{3}{8}$  of an inch, and a very fine platinum wire (one weighing 1.92 grain to the yard is the regulation size) is soldered across. The object of arranging the wires in this manner is that they shall not be in contact, and that the strain which they exert may be spent on the box, and not on the platinum wire joining them, which, being extremely thin, would be broken by even a very slight pull. The box is then filled with fine-grained powder, and the lid tied down. The wires of the fuse are then carefully joined to the long conducting wires.

which lead to the battery ; these should be of copper, and as thick as is convenient, so as to offer very little resistance : No. 16 gauge copper wire is a suitable size. The fuse is then introduced into the charge to be fired : if it is for a submarine explosion, the powder is contained in a canister, the neck of which, after the introduction of the fuse, is carefully fastened by means of cement. When contact is made with the battery, which is effected through the intervention of mercury cups, the current traversing the platinum wire renders it incandescent, which fires the fuse ; and thus the ignition is communicated to the charge in which it is placed.

The heating effect depends more on the size than on the number of the plates of a battery, for the resistance in the connecting wires is small. An iron wire may be melted by a single Wollaston's element, the zinc of which is 8 inches by 6. Hare's battery (781) has received its name *deflagrator* on account of its greater heating effect produced by the great surface of its plates.

When any circuit is closed, a definite amount of heat is produced throughout the entire circuit ; and the amount of heat produced in any particular part of the circuit is greater, the greater the proportion which the resistance of this part bears to the entire circuit. Hence in firing mines the wire to be heated should be of as small section and of as small conductivity as practicable. These conditions are well satisfied by platinum, which has over iron the advantage of being less brittle and of not being liable to rust. Platinum too has a low specific heat, and is thus raised to a higher temperature by the same amount of heat than a wire of greater specific heat.

On the other hand, the conducting wires should present as small a resistance as possible, a condition satisfied by a stout copper wire ; and again, as the heating effect of any circuit is proportional to the square of the strength, and as this is directly as the electromotive force, and inversely as the resistance, a battery with a high electromotive force and small resistance, such as Grove's or Bunsen's, should be selected.

By means of a heated platinum wire, parts of the body may be safely cauterised which could not be got at by a red-hot iron ; the removal of tumours may be effected by drawing a loop of platinum round their base, which is then gradually pulled together. It has been observed that when the temperature of the wire is about 600° C., the combustion of the tissues is so complete that there is no hæmorrhage ; while at 1500° the action of the wire is like that of a sharp knife.

**806. Laws of heating effects. Galvano-thermometer.**—Although the thermal effects are most obvious in the case of thin wires, they are not limited to them ; with thicker wires they may be perceived by means of delicate thermometric arrangements, by which also the laws of the heating effect may be investigated.

Such an arrangement is called a *galvano-thermometer*. It consists essentially of a glass vessel containing alcohol, in which is a delicate thermometer ; the wire to be investigated is fitted to two platinum wires fused in the well-ground stopper of the vessel. The current is passed through the platinum wires, and its strength measured by means of a tangent compass interposed in the circuit. By observing the increase of temperature in the thermometer in a given time, and knowing the weight of the alcohol, the mass of the wire



the specific heat, and the calorimetric values (440) of the vessel, and of the thermometer, compared with alcohol, the thermal effect which is produced by the current in a given time can be calculated.

By apparatus of this kind the laws of the thermal effects have been investigated by Lenz, Joule, and Becquerel. They are as follows :

I. *The heat disengaged in a given time is directly proportional to the square of the strength of the current, and to the resistance.*

II. *Whatever be the length of a wire, provided its diameter remains the same, and that the same quantity of electricity passes, the increase of temperature is the same in all parts of the wire.*

III. *For the same quantity of electricity, the increase of temperature in different parts of a wire is inversely as the fourth power of the diameter.*

If the current passes through a chain of platinum and silver wire of equal sizes, the platinum becomes more heated than the silver from its greater resistance ; and with a suitable current the platinum may become incandescent while the silver remains dark. This experiment was devised by Children.

If a long thin platinum wire be raised to dull redness by passing a voltaic current through it, and if part of it be cooled down by ice, the resistance of the cooled part is diminished, the intensity of the current increases, and the rest of the wire becomes brighter than before. If, on the contrary, a part of the feeble incandescent wire be heated by a spirit-lamp, the resistance of the heated part increases, for the effect is the same as that of introducing fresh resistance, the intensity of the current diminishes, and the wire ceases to be incandescent in the non-heated part.

The cooling by the surrounding medium exercises an important influence on the phenomenon of ignition. A round wire is more heated by the same current than the same wire which has been beaten out flat ; for the latter with the same section offers a greater surface to the cooling medium than the others. For the same reason, when a wire is stretched in a glass tube on which two brass caps are fitted air-tight, and the wire is raised to dull incandescence by the passage of a current, the incandescence is more vivid when the air has been pumped out of the tube, because it now simply loses heat by radiation, and not by communication to the surrounding medium.

Similarly, a current which will melt a wire in air will only raise it to dull redness in ether, and in oil or in water will not heat it to redness at all, for the liquids conduct heat away more readily than air does.

From the above laws it follows that the heating effect is the same in a wire whatever be its length, provided the current is constant ; but it must be remembered that by increasing the length of the wire we increase the resistance, and consequently diminish the intensity of the current ; further, in a long wire there is a greater surface, and hence more heat is lost by radiation and by conduction.

807. **Graphical representation of the heating effects in a circuit.**—The law representing the production of heat in a circuit in the unit of time is very well seen by the following geometrical construction due to Professor Foster, who has devised several similar methods of graphically representing electrical laws.

The heat  $H$  produced in a circuit in the unit of time, is proportional to

the square of the strength of the current  $C$ , and to the resistance  $R$ , that is  $H = C^2R$ ; but since  $C = \frac{E}{R}$ , we shall have  $H = \frac{E^2}{R}$ .

Draw a straight line  $DAB$ , and from any point  $A$  in it draw a line  $AC$ , at right angles to  $DAB$ , and of a length proportional to the electromotive force of the cell. Lay off a length  $AB$  proportional to the resistance of the circuit. Join  $CB$ , and at  $C$  draw a line at right angles to  $BC$  and let  $D$  be the point where the line cuts the line  $DAB$ . Then the length  $AD$  is proportional to the *heat* produced in the whole circuit in unit time. For the triangles  $ADC$  and  $ACB$  are similar, and therefore  $AD : AC = AC : AB$ , that is  $AD = \frac{AC^2}{AB}$ , that is  $H = \frac{E^2}{R}$ .

By drawing figures similar to the above it will be found that for a given electromotive force the heat is inversely proportional to the resistance, and

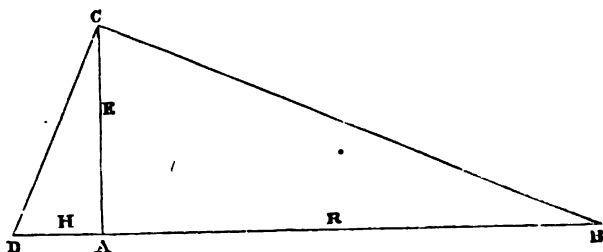

Fig. 657.

for a given resistance directly proportional to the square of the electromotive force. That is, if the resistance is doubled, the heat is reduced to one half; if the electromotive force is doubled the heat is quadrupled.

**808. Relation of heating effect to work of a battery.**—In every closed circuit chemical action is continuously going on; in ordinary circuits, the most common action is the solution of zinc in sulphuric acid, which may be regarded as an oxidation of the zinc to form oxide of zinc, and a combination of this oxide of zinc with sulphuric acid to form water and zinc sulphate. It is a true combustion of zinc, and this combustion serves to maintain all the actions which the circuit can produce, just as all the work which a steam-engine can effect has its origin in the combustion of fuel (461).

By independent experiments it has been found that, when a given weight of zinc is dissolved in sulphuric acid, a certain definite measurable *quantity* of heat is produced, which, as in all cases of chemical action, is the same, whatever be the rapidity with which the solution is effected. If this solution takes place while the zinc is associated with another metal so as to form a voltaic couple, the rapidity of the solution will be altered and the whole circuit will become heated—the liquid, the plates, the containing vessel as well as the connecting wire. But although the distribution of the heat is thus altered, its quantity is not. If the values of all the several heating effects in the various parts of the circuit be determined, it will still be found that however the resistance of the connecting wire be varied, this sum is exactly equivalent to that produced by the solution of a certain weight of zinc.

If the couple be made to do external mechanical work the case is different. Joule made the following remarkable experiment. A small zinc and copper couple were arranged in a calorimeter and the amount of heat determined while the couple was closed for a certain length of time by a short thick wire. The couple still contained in the calorimeter was next connected with a small electromagnetic engine (867), by which a weight was raised. It was thus found that the heat produced in the calorimeter in a given time—while therefore a certain amount of zinc was dissolved—was less while the couple was doing work than when it was not; and the amount of this diminution was the exact thermal equivalent of the work performed in raising the weight (483).

That the whole of the chemical work and disengagement of heat in the circuit of an ordinary cell has its origin in the solution of zinc in acid is confirmed by the following experiment due to Favre.

In the muffle of his calorimeter (450) five small zinc platinum elements were introduced; the other muffle contained a voltameter. Now when the element was closed until one equivalent of zinc was dissolved in the whole of the cells,  $\frac{1}{3}$  of an equivalent of water should be decomposed in the voltameter (820); which was found to be the case. In one case the current of the battery was closed without inserting the voltameter, and the heat disengaged during the solution of one equivalent of zinc was found to be 18796 thermal units; when however the voltameter was introduced, the quantity disengaged was only 11769 thermal units. Now the difference, 7027, is represented by the chemical work of decomposing  $\frac{1}{3}$  of an equivalent of water; this agrees very well with the number,  $6892 = \frac{34462}{5}$ , which represents the heat disengaged during the formation of  $\frac{1}{3}$  of an equivalent of water.

809. **Luminous effects.**—In closing a voltaic battery a spark is obtained at the point of contact, which is frequently of great brilliance. A similar spark is also perceived on breaking contact. These luminous effects are obtained when the battery is sufficiently powerful, by bringing the two electrodes very nearly in contact; a succession of bright sparks springs sometimes across the interval, which follow each other with such rapidity as to produce a continuous light. With eight or ten of Grove's elements brilliant luminous sparks are obtained by connecting one terminal of the battery with a file, and moving its point along the teeth of another file connected with the other terminal.

The most beautiful effect of the electric light is obtained when, with the terminals of the battery two pencils of charcoal are connected in the manner represented in fig. 658. The charcoal *b* is fixed, while the charcoal *a* can be raised and lowered by means of a rack and pinion motion, *c*. The two charcoals being placed in contact, the current passes, and their ends soon become incandescent. If they are then removed to a distance of about the tenth of an inch, according to the strength of the current, a luminous arc extends between the two points, which has an exceedingly brilliant lustre, and is called the *voltaic arc*.

The length of this arc varies with the force of the current. In air it may exceed 2 inches with a battery of 600 elements, arranged in six series of 100 each, provided the positive pole is uppermost, as represented in the figure;

if it is undermost, the arc is about one-third shorter. In vacuo the distance of the charcoal may be greater than in air; in fact, as the electricity meets with no resistance, it springs between the two charcoals, even before they are in contact. The voltaic arc can also be produced in liquids, but it is then much shorter, and its brilliancy is greatly diminished.

The voltaic arc has the property that it is attracted when a magnet is presented to it; a consequence of the action of magnets on currents (840).

Some physicists have considered the voltaic arc as formed of a very rapid succession of bright sparks. Its colour and shape depend on the nature

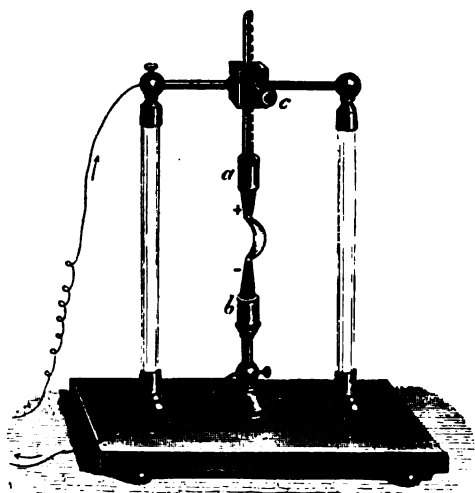

Fig. 658.

of the conductors between which it is formed, and hence it is probable that it is due to the incandescent particles of the conductor, which are volatilised and transported in the direction of the current—that is, from the positive to the negative pole. The more easily the electrodes are disintegrated by the current, the greater is the distance at which the electrodes can be placed. Charcoal, which is a very friable substance, is one of the bodies which gives the largest luminous arc.

Recent researches by Edlund have shown that this disintegration of the terminals by the voltaic arc gives rise to an electromotive force opposed in direction to that of the main current.

Davy first made the experiment of the electric light, in 1801, by means of a battery of 2,000 plates, each 4 inches square. He used charcoal points made of light wood charcoal which had been heated to redness, and immersed in a mercury bath; the mercury, penetrating into the pores of the charcoal, increased its conductivity. When any substance was introduced into the voltaic arc produced by this battery, it became incandescent; platinum melted like wax in the flame of a candle; sapphire, magnesia, lime, and most refractory substances were fused. Fragments of diamond, of charcoal,

and of graphite rapidly disappeared without undergoing any previous fusion.

As charcoal rapidly burns in air, it was necessary to operate in vacuo, and hence the experiment was for a long time made by fitting the two points in an electric egg, like that represented in fig. 614. At present the electrodes are made of gas graphite, a modification of charcoal deposited in gas retorts; this is hard and compact, and only burns slowly in air: hence it is unnecessary to operate in vacuo. When the experiment is made in vacuo, there is no combustion, but the charcoal wears away at the positive pole, while it is somewhat increased on the negative pole, indicating that there is a transport of solid matter from the positive to the negative pole.

810. **Foucault's experiment.**—This consists in projecting on a screen the image of the charcoal points produced in the camera obscura at the moment at which the electric light is formed (fig. 659). By means of this experiment,

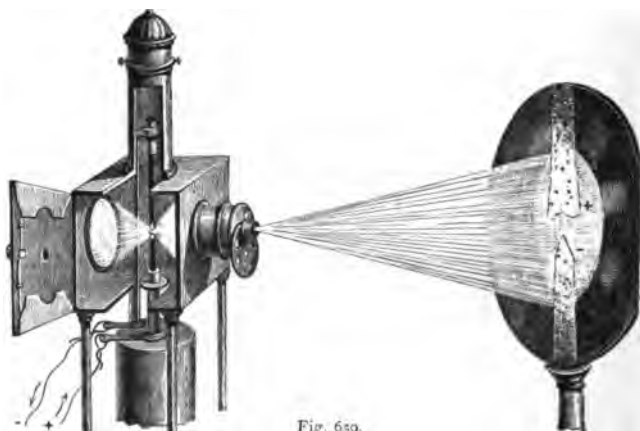

which is made by the photo-electric microscope already described (fig. 487), the two charcoals can be readily distinguished, and the positive charcoal is seen to become somewhat hollow and diminish, while the other increases. The globules represented on the two charcoals arise from the fusion of a small quantity of silica contained in the charcoal. When the current begins to pass, the negative charcoal first becomes luminous, but the light of the positive charcoal is the brightest; as it also wears away the most rapidly, it ought to be rather the larger.

811. **Regulator of the electric light.**—When the electric light is to be used for illumination, it must be as continuous as other modes of lighting. For this purpose, not only must the current be constant, but the distance of the charcoals must not alter, which necessitates the use of some arrangement for bringing them nearer together in proportion as they wear away. One of the best modes of effecting this is by an apparatus invented by M. Duboscq.

In this regulator the two charcoals are movable, but with unequal velocities, which are virtually proportional to their waste. The motion is transmitted by a drum placed on the axis, *xy* (fig. 660). This turns in the direction of the arrows two wheels, *a* and *b*, the diameters of which are as 1 : 2,

and which respectively transmit their motion to two rackworks,  $C'$  and  $C$ .  $C$  lowers the positive charcoal,  $p$ , by means of a rod sliding in the tube,  $H$ , while the other  $C'$  raises the negative charcoal,  $n$ , half as rapidly. By means

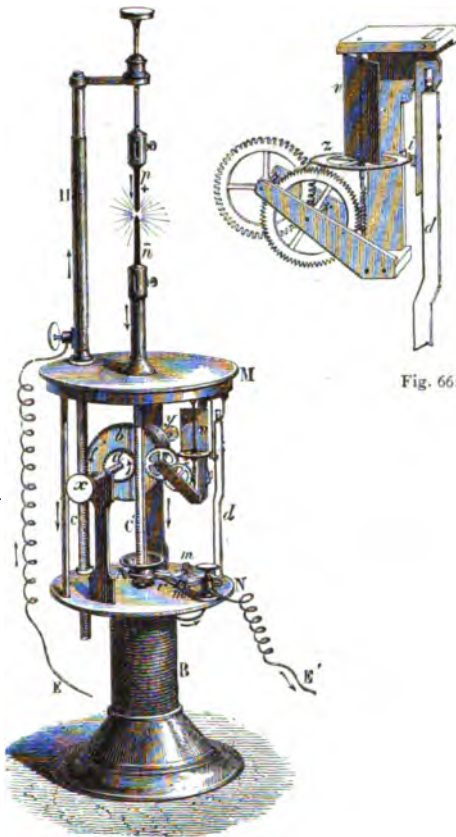

Fig. 66o.

Fig. 66t.

of the milled head  $y$  the drum can be wound up, and at the same time the positive charcoal moved by the hand; the milled head  $x$  moves the negative charcoal also by the hand, and independently of the first. For this purpose the axis,  $xy$ , consists of two parts pressing against each other with some force, so that, holding the milled head  $x$  between the fingers, the other,  $y$ , may be moved, and by holding the latter the former can be moved. But the friction is sufficient when the drum works to move the two wheels  $a$  and  $b$  and the two rackworks.

The two charcoals being placed in contact, the current of a powerful battery of 40 to 50 elements reaches the apparatus by means of the wires  $F$  and  $E'$ . The current rising in  $H$  descends by the positive charcoal, then by the negative charcoal, and reaches the apparatus, but without passing

into the rackwork, C, or into the part on the right of the plate, N; these pieces being insulated by ivory discs placed at their lower part. The current ultimately reaches the bobbin B, which forms the foot of the regulator, and passes into the wire, E'. Inside the bobbin is a bar of soft iron, which is magnetised as long as the current passes in the bobbin, and demagnetised when it does not pass, and this temporary magnet is the regulator. For this purpose it acts attractively on an armature of soft iron, A, open in the centre so as to allow the rackwork C' to pass, and fixed at the end of a lever, which works on two points, *mm*, and transmits a slight oscillation to a rod, *d*, which, by means of a catch, *i*, seizes the wheel *x*, as is seen on a larger scale in figure 661. By an endless screw, and a series of toothed wheels, the stop is transmitted to the drum, and the rackwork being fixed, the same is the case with the carbons. This is what takes place so long as the magnetisation in the bobbin is strong enough to keep down the armature, A; but in proportion as the carbons wear away, the current becomes feebler, though the voltaic arc continues, so that ultimately the attraction of the magnet no longer counterbalances a spring, *r*, which continually tends to raise the armature. It then ascends, the piece *d* disengages the stop *i*, the drum works, and the carbons come nearer; they do not, however, touch, because the strength of the current gains the upper hand, the armature A is attracted, and the carbons remain fixed. As their distance only varies within very

narrow limits, a regular and continuous light is obtained with this apparatus until the carbons are quite used.

By means of a regulator, M. Duboscq illuminates the photogenic apparatus represented in fig. 487, by which all the optical experiments may be performed for which solar light was formerly necessary.

812. **Browning's regulator.** — A much simpler apparatus, represented in fig. 662, has been devised by Browning. It has the great advantage of being less costly than the other lamps, and also of requiring a smaller number of elements to work it. The current enters the lamp by a wire attached to a binding screw on the base of the instrument, passing up the pillar by the small electromagnet to the centre pillar along the top of the horizontal bar, down the left-hand bar through the two carbons, and away by a wire attached to a binding screw on the left hand. A tube holding the upper carbon slides freely up and down a tube at the end of the cross-piece, and would by its own weight rest on the lower carbon, but the electromagnet is provided with a



Fig. 662.

keeper, to which is attached a rest that encircles the carbon tube and grasps it. When the electromagnet works and attracts the keeper, the rest tightens and thereby prevents the descent of the carbon. When the keeper is not attracted the rest loosens, and the carbon-holder descends.

When the two carbons are at rest, on making contact with a battery the current traverses both carbons and no light is produced. But if the upper carbon be raised ever so little, a brilliant light is emitted. When the lamp is thus once set to work, the rod attached to the upper carbon may be let go, and the magnet will afterwards keep the lamp at work. For when some of the carbon is consumed, and the interval between the two is too great for the current to pass, the magnet loses some of its power, the keeper loosens its hold on the carbon, and this descends by its own weight. When they are sufficiently near, but before they are in contact, the current is re-established; the magnet again draws on the keeper, and the keeper again checks the descent of the carbon, and so forth. Thus the points are retained at the right distances apart, and the light is continuous and brilliant.

**813. Properties and intensity of the electric light.**—The electric light has similar chemical properties to solar light: it effects the combination of chlorine and hydrogen, acts chemically on chloride of silver, and can be applied in photography, though not for taking portraits, as it fatigues the sight too greatly.

Passed through a prism, the electric light, like that of the sun, is decomposed and gives a spectrum. Wollaston, and more especially Fraunhofer, have found that the spectrum of the electric light differs from that of other lights, and of sun-light by the presence of several very bright lines, as has been already stated. Wheatstone was the first to observe that by using electrodes of different metals, the spectrum and the lines are modified.

Masson who experimented upon the light of the electric machine, that of the voltaic arc, and that of Ruhmkorff's coil, found the same colours in the electric spectrum as in the solar spectrum, but traversed by very brilliant luminous bands of the same shades as that of the colour in which they occur. The number and position of these bands do not depend on the intensity of the light, but, as we have seen, upon the substances between which the voltaic arc is formed.

With carbon the lines are remarkable for their number and brilliancy; with zinc the spectrum is characterised by a very marked apple-green tint; silver produces a very intense green; with lead a violet tint predominates, and so on with other metals.

Bunsen, in experimenting with 48 couples, and removing the charcoals to a distance of a quarter of an inch, has found that the intensity of the electric light is equal to that of 572 candles.

Fizeau and Foucault have compared the chemical effects of the solar and the electric lights, by investigating their action on iodized silver plates. Representing the intensity of the sun's light at midday at 1000, these physicists found that that of 46 Bunsen's elements was 235, while that of 80 elements was only 238. It follows that the intensity does not increase to any material extent with the number of the couples; but experiment shows that it increases considerably with their surface. For with a battery of 46 elements, each consisting of three elements, with their zinc and copper respectively



united so as to form one element of triple surface (801), the intensity was 385, the battery working for an hour ; that is to say, more than a third of the intensity of the solar light.

Despretz observes that too great precautions cannot be taken against the effects of the electric light when they attain a certain intensity. The light of 100 couples, he says, may produce very painful affections of the eyes. With 600, a single moment's exposure to the light is sufficient to produce very violent headaches and pains in the eye, and the whole frame is affected as by a powerful sunstroke.

Mr. Way obtained a very bright light by passing the electric current along a stream of mercury. The light is produced by the incandescence of the mercury vapour ; it has a somewhat flickering character, and a greenish tinge.

Attempts have been made to apply the electric light to the illumination of rooms, and even of streets ; but partly the cost, and partly the difficulty of producing with it a uniform illumination, inasmuch as the shadows are thrown into too sharp relief, have hitherto been great obstacles to its use. Yet it is advantageously applied in special cases, such as the photo-electric microscope illuminations in theatres, etc.

814. **Mechanical effects of the battery.**—Under this head may be included the motion of solids and liquids effected by the current. An example of the former is found in the voltaic arc, in which there is a passage of the molecules of carbon from the positive to the negative pole (809).

The mechanical action of the current may be shown by means of the following experiment (fig. 663). A glass tube AB bent at the two ends, about

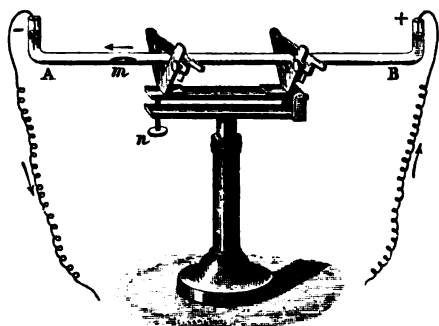

Fig. 663.

50 cm. in length and 1 cm. in diameter, is almost filled with dilute sulphuric acid, and a globule of mercury, *m*, is introduced. The whole is fixed in a support, and the level of the tube can be adjusted by the screw *n*, the drop of mercury itself serving as index.

When the two poles of a battery of 4 or 5 cells are introduced into the two ends, the globule of mercury elongates and moves towards the negative pole with a velocity which increases with the number of elements. With 24, a long column of mercury can be moved through a tube a metre in length ; with 50, the velocity is greater and the mercury divides into glo-

bules, all moving in the same direction. If the direction of the current is reversed, the mercury first remains stationary, and then moves in the opposite direction.

If the tube is gently inclined towards the positive pole, the mercury is still moved with the current; and a moment is at length reached at which there is equilibrium between the impulsive force of the current and the weight of the mercury. The component of this weight parallel to the plane may then be taken as representing the mechanical action of the current which traverses the globule of mercury.

A similar phenomenon, known as *electrical endosmose*, is observed in the following experiment, due to Porret. Having divided a glass vessel into two compartments by a porous diaphragm he poured water into the two compartments to the same height, and immersed two platinum electrodes in connection with a battery of 80 elements. As the water became decomposed, part of the liquid was carried in the direction of the current, through the diaphragm, from the positive to the negative compartment, where the level rose above that in the other compartment. A solution of blue vitriol is best for these experiments, because then the disturbing influence of the disengagement of gas at the negative electrode is avoided.

The converse of these phenomena is observed when a liquid is forced through a diaphragm by mechanical means. Such currents, which were discovered by Quincke, are called *diaphragm currents*.

A porous diaphragm *p* is fixed in a glass tube (fig. 664), in which are also fused two platinum wires terminating in platinum electrodes, *a* and *b*; on forc-



Fig. 664.

ing a liquid through the diaphragm the existence of a current is evidenced by a galvanometer with which the wires are connected, the direction of which is that of the flow of the liquid.

According to Zöllner, all circulatory motions in liquids, especially when they take place in partial contact with solids, are accompanied by electrical currents which have generally the same direction as that in which the current flows.

According to Wertheim, the elasticity of metal wires is diminished by the current, and not by the heat alone, but by the electricity; he has also found that the cohesion is diminished by the passage of a current.

To the mechanical effects of the current may be assigned the sounds produced in soft iron when submitted to the magnetising action of a discontinuous current—a phenomenon which will be subsequently described.

**814a. Electro-capillary phenomena.**—If a drop of mercury be placed in dilute sulphuric acid containing a trace of chromic acid, and the end of a bright iron wire be so fixed that it dips in the acid and just touches the edge of the mercury, the latter begins a series of regular vibrations which may last

for hours. The explanation of this phenomenon, which was first observed by Kühne, is as follows :—When the iron first touches the mercury, an iron-mercury couple is formed, in consequence of which the surface of the mercury is polarised by the deposition of an invisible layer of hydrogen; this polarisation (782) increases the surface-tension of the mercury, it becomes rounder, and contact with the iron is broken; the chromic acid present depolarises the mercury, its original shape is restored, the couple is again formed, and the process repeats itself continuously.

Lippmann has been led by the observation of this phenomenon to a series of interesting experimental results, which have demonstrated a relation between capillary and electrical phenomena. Of these results the most important is the construction of a capillary electrometer.

A glass tube A (fig. 665) is drawn out on a fine point, and is filled with

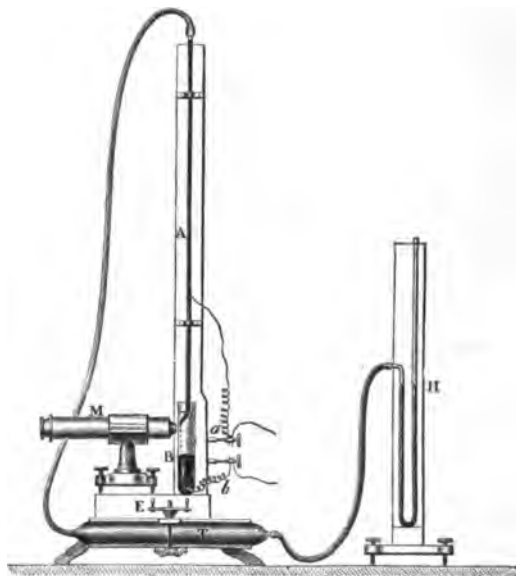

Fig. 665.

mercury; its lower end dips in a glass vessel B, containing mercury at the bottom and dilute sulphuric acid at the top. Platinum wires are fused in the tubes A and B, and terminate in the binding screws *a* and *b* respectively.

Now at the beginning of the experiment the position of the mercury in the drawn-out tube is such that the capillary action due to the surface tension at the plane of separation of the mercury in the tube and the liquid, is sufficient to counterbalance the pressure of the column A. This position is observed by means of a microscope, the focus of which is at the fiducial mark on the glass at which the mercury stops. If now a difference of potential be established, by connecting the poles of a cell with the wires *a* and *b*, the surface-tension is increased, the mercury ascends in the capillary

tube, and in order to bring the meniscus back to its former position, the pressure on A must be increased. This is most simply effected by means of a thick caoutchouc tube T, connected with the top of A, and with a manometer H; and which can be more or less compressed by means of a screw E. The difference in level of the two legs of the manometer is thus a measure of the increase of the surface-tension, and therewith of the difference of potential. Lippmann found by special experiments that this increase is almost directly proportional to the electromotive force, up to about 0.9 of a Daniell's element. Each electrometer requires a special table of graduation; but when once this is constructed it can be directly used for determining electromotive forces. It should not be used for greater electromotive forces than 0.6 of a Daniell; but it can estimate the one-thousandth part of this quantity, and, as its electrical capacity is very small, it can show rapid changes of potential, which ordinary electrometers cannot do. For very small electro-motive forces, the pressure is kept constant, and the displacement of the meniscus is measured by the microscope.

815. **Chemical effects.**—These are among the most important of all the actions, either of the simple or compound circuit. The first decomposition effected by the battery was that of water obtained in 1800 by Carlisle and Nicholson by means of a voltaic pile. Water is rapidly decomposed by 4 or 5 Bunsen's cells; the apparatus (fig. 666) is very convenient for the purpose. It consists of a glass vessel fixed on a wooden base. In the bottom of the vessel two platinum electrodes, *k* and *n*, are fitted, communicating by means of copper wires with the binding screws. The vessel is filled with water to which some sulphuric acid

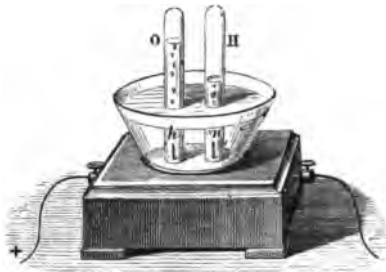

Fig. 666.

has been added to increase its conductivity, for pure water is a very imperfect conductor; two glass tubes filled with water are inverted over the electrodes, and on interposing the apparatus in the circuit of a battery, decomposition is rapidly set up, and gas bubbles rise from the surface of each pole. The volume of gas liberated at the negative pole is about double that at the positive, and on examination the former gas is found to be hydrogen and the latter gas oxygen. This experiment accordingly gives at once the qualitative and quantitative analysis of water. The oxygen thus obtained has the peculiar and penetrating odour observed when an electrical machine is worked (768), and which is due to ozone. The water contains at the same time some peroxide of hydrogen, in producing which some oxygen is consumed. Moreover, oxygen is somewhat more soluble in water than hydrogen. Owing to these causes the volume of oxygen is less than that required by the composition of water, which is two volumes of hydrogen to one of oxygen. Hence voltametric measurements are most exact when the hydrogen alone is considered, and when this is liberated at the surface of a small electrode.

816. **Electrolysis.**—To those substances which, like water, are resolved into their elements by the voltaic current, the term *electrolyte* has been applied by Faraday, to whom the principal discoveries in this subject and the nomenclature are due. *Electrolysis* is the decomposition by the voltaic battery; the positive electrode was by Faraday called the *anode*, and the negative electrode the *kathode*. The products of decomposition are *iones*; *katione*, that which appears at the kathode; and *anione*, that which appears at the anode.

By means of the battery, the compound nature of several substances which had previously been considered as elements has been determined. By means of a battery of 250 couples, Davy, shortly after the discovery of the decomposition of water, succeeded in decomposing the alkalis potass and soda, and proved that they were the oxides of the hitherto unknown metals

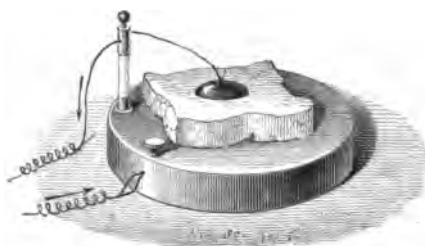

Fig. 667.

*potassium and sodium.* The decomposition of potass may be demonstrated with the aid of a battery of 4 to 6 elements in the following manner; a small cavity is made in a piece of solid caustic potass, which is moistened, and a drop of mercury placed in it (fig. 667). The potass is placed on a piece of platinum connected with the positive pole of the battery. The mercury is then touched with the negative pole. When the current passes, the potass is decomposed, oxygen is liberated at the positive pole, while the potassium liberated at the negative pole amalgamates with the mercury. On distilling this amalgam out of contact with air, the mercury passes off, leaving the potassium.

The decomposition of binary compounds—that is, bodies containing two elements—is quite analogous to that of water and of potass; one of the elements goes to the positive, and the other to the negative pole. The bodies separated at the positive pole are called *electronegative* elements, because at the moment of separation they are considered to be charged with negative electricity, while those separated at the negative pole are called *electropositive* elements. One and the same body may be electronegative or electropositive, according to the body with which it is associated. For instance, sulphur is electronegative towards hydrogen, but is electropositive towards oxygen. The various elements may be arranged in such a series that any one in combination is electronegative to any following, but electropositive towards all preceding ones. This is called the *electrochemical series*, and begins with

oxygen as the most electronegative element, terminating with potassium as the most electropositive.

The decomposition of hydrochloric acid into its constituents, chlorine and hydrogen, may be shown by means of the apparatus represented in fig. 668.

Carbon electrodes must, however, be substituted for those of platinum, which is attacked by the liberated chlorine; a quantity of salt also must be added to the hydrochloric acid, in order to diminish the solubility of the liberated chlorine. The decomposition of iodide of potassium may be demonstrated by means of a single element. For this purpose a piece of bibulous paper is soaked with a solution of starch, to which iodide of potassium is added. On touching this paper with the electrodes, a blue spot is produced at the positive pole, due to the action of the liberated iodine on the starch.

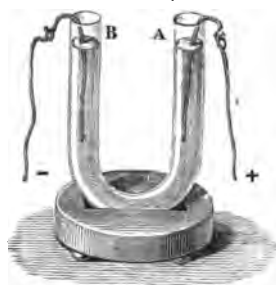

Fig. 668.

817. **Decomposition of salts.**—Ternary salts in solution are decomposed by the battery, and then present effects varying with the chemical affinities and the intensity of the current. In all cases the acid, or the body which is chemically equivalent to it, is electronegative in its action towards the other constituent. The decomposition of salts may be readily shown by means of the bent tube represented in fig. 668. This is nearly filled with a saturated solution of a salt, say sulphate of sodium, coloured with tincture of violets. The platinum electrodes of a battery of four Bunsen's elements are then placed in the two legs of the tube. After a few minutes the liquid in the positive leg, A, becomes of a red, and that in the negative leg, B, of a green colour, showing that the salt has been resolved into acid which has passed to the positive, and into a base which has gone to the negative pole, for these are the effects which a free acid and a free base respectively produce on tincture of violets.

In a solution of sulphate of copper, free acid and oxygen gas appear at the positive electrode, and metallic copper is deposited at the negative electrode. In like manner, with nitrate of silver, metallic silver is deposited on the negative, while free acid and oxygen appear at the positive electrode.

This decomposition of salts was formerly explained by saying that *the acid was liberated at the positive electrode and the base at the negative*. Thus sulphate of potassium,  $K_2OSO_3$ , was considered to be resolved into sulphuric acid,  $SO_3$ , and potash,  $K_2O$ . This view regarded salts composed of three elements as different in their constitution from binary or haloid salts. Their electrolytic department has led to a mode of regarding the constitution of salts which brings all classes of them under one category. In sulphate of potassium, for instance, the electropositive element is potassium, while the electronegative element is a complex of sulphur and oxygen, which is regarded as a single group,  $SO_4$ , and to which the name *oxy-sulphion* may be assigned. The formula of sulphate of potassium would thus be  $K_2SO_4$ , and its decomposition would be quite analogous to that of chloride of potassium,  $KCl$ , chloride of lead,  $PbCl_2$ , iodide of potassium,  $KI$ . The electronegative group  $SO_4$  corresponds to a molecule of chlorine or iodine. In the decomposition

of sulphate of potassium, the potassium liberated at the negative pole decomposes water, forming potash and liberating hydrogen. In like manner the electronegative constituent  $\text{SO}_4$ , which cannot exist in the free state, decomposes into oxygen gas, which is liberated, and into anhydrous sulphuric acid,  $\text{SO}_3$ , which immediately combines with water to form ordinary sulphuric acid,  $\text{H}_2\text{SO}_4$ . In fact, where the action of the battery is strong these gases are liberated at the corresponding poles; in other cases they combine in the liquid itself, reproducing water. The constitution of sulphate of copper,  $\text{CuSO}_4$ , and of nitrate of silver,  $\text{AgNO}_3$ , and their decomposition, will be readily understood from these examples.

**818. Transmissions effected by the current.**—In chemical decompositions effected by the battery there is not merely a separation of the elements, but a passage of the one to the positive and of the other to the negative electrode. This phenomenon has been demonstrated by Davy by means of several experiments, of which the two following are examples:—

i. He placed solution of sulphate of sodium in two capsules connected by a thread of asbestos moistened with the same solution, and immersed the positive electrode in one of the capsules, and the negative electrode in the other. The salt was decomposed, and at the expiration of some time all the sulphuric acid was found in the first capsule, and the soda in the second.

ii. Having taken three glasses, A, B, and C (fig. 669), he poured into the first, solution of sulphate of sodium, into the second dilute syrup of violets,

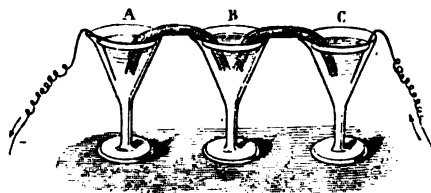

Fig. 669.

and into the third pure water, and connected them by moistened threads of asbestos. The current was then passed in the direction from C to A. The sulphate in the vessel A was decomposed, and in the course of time there was nothing but soda in this glass, which formed the negative end, while all the acid

had been transported to the glass C, which was positive. If, on the contrary, the current passed from A to C, the soda was found in C, while all the acid remained in A; but in both cases the remarkable phenomenon was seen that the syrup of violets in B neither became red nor green by the passage of the acid or base through its mass, a phenomenon the explanation of which is based on the hypothesis enunciated in the following paragraph.

**819. Grothüss's hypothesis.**—Grothüss has given the following explanation of the chemical decompositions effected by the battery. Adopting the hypothesis that in every binary compound, or body which acts as such, one of the elements is electropositive, and the other electronegative, he assumes that, under the influence of the contrary electricities of the electrodes, there is effected, in the liquid in which they are immersed, a series of successive decompositions and recompositions from one pole to the other. Hence it is only the elements of the terminal molecules which do not recombine, and remaining free appear at the electrodes. Water, for instance, is formed of one atom of oxygen and two atoms of hydrogen, the first gas being electronegative, the second electropositive. Hence when the liquid is traversed by a suffi-

ciently powerful current, the molecule *a* in contact with the positive pole arranges itself as shown in fig. 670, that is, the oxygen is attracted and the hydrogen repelled. The oxygen of this molecule is then given off at the positive electrode, the liberated hydrogen immediately unites with the oxygen of the molecule *b*, the hydrogen of this with the oxygen of the molecule *c*, and so on, to the negative electrode, where the last atoms of hydrogen become free and appear on the poles. The same theory applies to the metallic oxides, to the acids and salts, and explains why in the experiment mentioned in the preceding paragraph the syrup of violets in the vessel B becomes neither red nor green. The reason why, in the fundamental experiment, the hydrogen is given off at the negative pole when the circuit is closed will be readily understood from a consideration of this hypothesis.



Fig. 670.

Clausius objects to this theory, that according to it a very great force must be required for overcoming the affinity for each other of the oppositely electrolysed particles of the compound; and that below a certain minimum strength of current no decomposition could occur. Now Buff has shown that the action of even the feeblest currents continued for a long time can produce decompositions. Again, when the necessary strength of the current is obtained it should be sudden and complete; whereas we know it to be proportional to the strength of the current.

To overcome this difficulty Clausius applies the theory now generally admitted of the constitution of liquids. The particles of a compound liquid have not the rigid unalterable condition of a solid body; they are in a perpetual state of separation and reunion, so that we must suppose compound bodies and their elementary constituents to coexist with each other in a liquid. Water, for instance, contains particles of water, together with particles of oxygen and of hydrogen; the former are being continually decomposed and the latter continually reunited. When the voltaic current passes it acts on the motion of the molecules in such a manner that the negatively electrical particles of oxygen pass to the positive electrodes, and the positively electrical particles of hydrogen to the negative electrode. Hence the current does not bring about the decomposition, but utilises it, to give definite direction to the particles which are already separated.

**820. Laws of electrolysis.**—The laws of electrolysis were discovered by Faraday; the most important of them are as follows:

- I. *Electrolysis cannot take place unless the electrolyte is a conductor.* Hence ice is not decomposed by the battery, because it is a bad conductor. Other bodies, such as oxide of lead, chloride of silver, etc., are only electrolysed in a fused state—that is, when they can conduct the current.
- II. *The energy of the electrolytic action of the current is the same in all its parts.*
- III. *The same quantity of electricity—that is, the same electric current—decomposes chemically equivalent quantities of all the bodies which it tra-*



verses; from which it follows, that the weights of elements separated in these electrolytes are to each other as their chemical equivalents.

In a circuit containing a voltmeter V, Faraday introduced a tube, A B, containing chloride of tin kept in a state of fusion by the heat of a spirit lamp (fig. 671). In the bottom of this the negative pole was fused, while the positive electrode consisted of a rod of graphite; when the current passed chlorine was liberated at the positive, while tin collected at the negative pole; in like manner oxide of lead was electrolysed and yielded lead at the negative and oxygen at the positive pole. Comparing the quantities of substances liberated, they are found to be in a certain definite relation. Thus for every 18 parts of water decomposed in the voltmeter

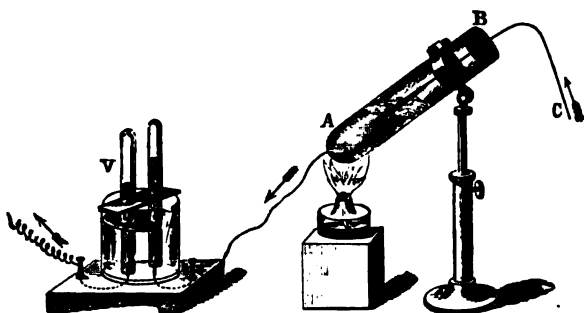

Fig. 671.

there will be liberated 2 parts of hydrogen, 207 parts of lead, and 117 of tin at the respective negative electrodes, and 16 parts of oxygen, and 71 (or  $2 \times 35.5$ ) parts of chlorine at the corresponding positive electrode. Now these numbers are exactly as the equivalents (not as the atomic weights) of the bodies.

It will further be found that in each of the cells of the battery 65 parts by weight of zinc have been dissolved, for every two parts by weight of hydrogen liberated; that is, that for every equivalent of a substance decomposed in the circuit one equivalent of zinc is dissolved. This is the case whatever be the number of cells. An increase in the number only has the effect of overcoming the great resistance which many electrolytes offer, and of accelerating the decomposition. It does not increase the quantity of electrolyte decomposed. If in any of the cells more than 65 parts of zinc are dissolved for every two parts of hydrogen liberated, this arises from a disadvantageous succeeding local action; and the more perfect the battery, the more nearly does it approach this ratio.

IV. It follows from the above law, that *the quantity of a body decomposed in a given time is proportional to the strength of the current*. On this is founded the use of Faraday's *voltmeter*, in which the intensity of a current is ascertained from the quantity of water which it decomposes in a given time. It consists of a glass vessel, in which two platinum electrodes are fixed. In the neck of a vessel a bent delivery tube is fitted, and the mixed gases are collected in a graduated cylinder, so that their volume can be deter-

mined, which, reduced to a constant temperature and pressure, is a measure of their quantity.

The use of this voltmeter appears simple and convenient; and hence some physicists have proposed *as unit of the strength of the current, that current which in one minute yields a cubic centimetre of mixed gas reduced to the temperature 0° and the pressure 760 mm.* Yet, for reasons mentioned before (815), the measurements should be based on the volume of hydrogen liberated.

The *silver voltmeter* is an instrument for measuring the intensity of the current. A solution of nitrate of silver of known strength is placed in a platinum dish which is connected with the negative pole; in this solution is placed the positive pole, which consists of a rod of silver wrapped round with muslin. The silver which separates at the negative pole is washed, dried, and weighed; and the weight thus produced in a given time is a measure of the intensity of the current. The silver particles which become detached from the positive pole are retained in the muslin.

The current from the electrical machine, which is of very high intensity, is capable of traversing any electrolyte, but the quantity which it can decompose is extremely small as compared even with the smallest voltaic apparatus, and it must be concluded that the quantity developed by the frictional machine is very small as compared with that developed by chemical action.

It has been calculated by Weber, that if the quantity of positive electricity required to decompose a grain of water were accumulated on a cloud at a distance of 3,000 feet from the earth's surface, it would exert an attractive force upon the earth of upwards of 1,500 tons.

**821. Comparison between the tangent galvanometer and the voltmeter.**—There are several objections to the use of the voltmeter. In the first place, it does not indicate the strength at any given moment, for in order to obtain measurable quantities of gas the current must be continued for some time. Again, the voltmeter gives no indications of the changes which take place in this time, but only the mean intensity. It offers also great resistance, and can thus only be used in the case of strong currents; for such currents either do not decompose water, or only yield quantities too small for accurate measurement. In addition to this, the indications of the voltmeter depend not only on the intensity of the current, but on the acidity of the water, and on the distance and size of the electrodes.

The magnetic measurements are preferable to the chemical ones. Not only are they more delicate and offer less resistance, but they give the intensity at any moment. On the other hand, indications furnished by the tangent galvanometer hold only for one special instrument. They vary with the diameter of the ring and the number of turns; moreover, one and the same instrument will give different indications on different places, seeing that the force of the earth's magnetism varies from one place to another (674).

The indications of the two instruments may, however, be readily compared with one another. For this purpose the voltmeter and the tangent galvanometer are *simultaneously* inserted in the circuit of a battery, and the deflection of the needle and the amount of gas liberated in a given time are noted. In one special set of experiments the following results were obtained:—

Number of Elements.	Deflection.	Gas liberated in three minutes.
12	28.5°	125cc.
8	24.8	106
6	22.0	93
3	13.75	56
2	6.9	24

If we divide the tangents of the angles into the corresponding volumes of gas liberated in *one* minute, we should obtain a constant magnitude which represents how much gas is developed in a minute by a current which could produce on the tangent galvanometer the deflection  $45^\circ$ , for  $\text{tang. } 45^\circ = 1$ . Making this calculation with the above observations, we obtain a set of closely agreeing numbers, the mean of which is 76.5. The gas was measured under a pressure of 737 mm. and at a temperature of  $15^\circ$ , and therefore under normal conditions (321) its volume would be 70 cubic centimetres. That is to say, this is the volume of gas which corresponds to a deflection of  $45^\circ$ .

Hence in chemical measure the strength  $C$  of a current which produces in *this* particular tangent galvanometer a deflection of  $\phi^\circ$  is

$$C = 70 \text{ tang. } \phi.$$

For instance, supposing a current produced in this tangent compass a deflection of  $54^\circ$ , this current, if it passed through a voltameter, would liberate in a minute  $70 \times \text{tang. } 54^\circ = 70 \times 1.376 = 96.32$  cubic centimetres of gas.

If once the *reduction factor* for a tangent galvanometer has been determined, the strength of any current may be readily calculated in chemical measure by a simple reading of the angle of deflection. This reduction factor of course only holds for one special instrument, and for experiments on the same place, seeing that the force of the earth's magnetism varies in different places.

The indications of the sine-compass may be compared with those of the galvanometer in a similar manner.

**822. Polarisation.**—When the platinum electrodes, which have been used in decomposing water, are disconnected from the battery, and connected with a galvanometer, the existence of a current is indicated which has the opposite direction to that which had previously passed. This phenomenon is explained by the fact that oxygen has been condensed on the surface of the positive plate, and hydrogen on the surface of the negative plate, analogous to what has been already seen in the case of the non-constant batteries (782). The effect of this is to produce two different electromotors, which produce a current opposed in direction to the original one, and which, therefore, must weaken it. As the two electrodes thus become the poles of a new current, they are said to be *polarised*, and the current is called a *polarisation-current*.

On this principle batteries may be constructed of pieces of metal of the same kind—for instance, platinum—which otherwise gives no current. A piece of moistened cloth is interposed between each pair, and each end of this system is connected with the poles of a battery. After some time the

apparatus has received a charge, and if separated from the battery can itself produce all the effects of a voltaic battery. Such batteries are called *secondary* batteries. Their action depends on an alteration of the surface of the metal produced by the electric current; the constituents of the liquid with which the cloth is moistened having become accumulated on the opposite plates of the circuit.

A dry pile which has become inactive may be used as a secondary battery. When a current is passed through it, in a direction contrary to that which the active battery yields, it then regains its activity.

To this class belongs *Planté's* secondary battery, which consists of two concentric cylinders of sheet lead, which do not touch, and are immersed in dilute acid. They are charged by being placed in contact with a battery of two or three cells, and there is an arrangement by which they can be detached from the battery and their current utilised. They serve in a certain sense to store up and transform the power of the primary battery, and produce effects of great intensity.

823. **Grove's gas battery.**—On the property, which metals have, of condensing gases on their surfaces, Grove constructed his *gas battery*, fig. 672. A single cell consists of two glass tubes, B and A, in each of which is fused a

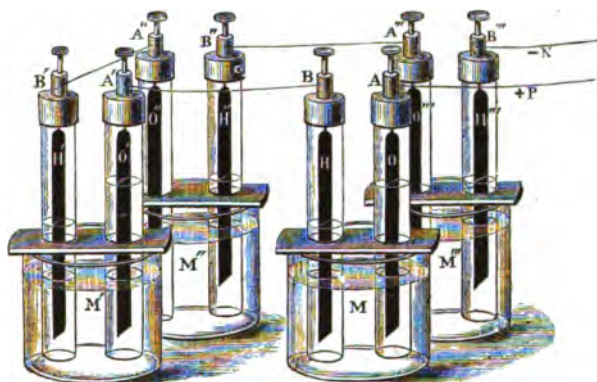

Fig. 672.

platinum electrode, provided on the outside with binding screws. These electrodes are made more efficient by being covered with finely divided platinum. One of the tubes is partially filled with hydrogen, and the other partially with oxygen, and they are inverted over dilute sulphuric acid, so that half the platinum is in the liquid and half in gas. On connecting the electrodes with a galvanometer, the existence of a current is indicated, whose direction in the connecting wire is from the platinum in oxygen to that in hydrogen; so that the latter is negative towards the former. As the current passes through water this is decomposed; oxygen is separated at the positive plate and hydrogen at the other. These gases unite with the gases condensed on their surface, so that the volume of gas in the tubes gradually diminishes, but in the ratio of one volume of oxygen to two volumes of hydrogen. These

elements can be formed into a battery (fig. 672) by joining the dissimilar plates with one another just as they are joined in an ordinary battery. One element of such a battery is sufficient to decompose iodide of potassium, and four will decompose water.

**874. Passive state of iron.**—With polarisation is probably connected a very remarkable chemical phenomenon, which many metals exhibit, but more especially iron. When this is immersed in concentrated nitric acid it is unattacked. This condition of iron is called the *passive state*, and upon it depends the possibility of the zinc-iron battery (786). It is probable that in the above experiment a thin superficial layer of proto-sesquioxide of iron is formed, which is then negative towards platinum.

**825. Nobili's rings.**—When a drop of acetate of copper is placed on a silver plate, and the silver is touched in the middle of the drop with a piece of zinc, there are formed around the point of contact a series of copper rings alternately dark and light. These are *Nobili's coloured rings*. They may be obtained in beautiful iridescent colours by the following process: A solution of oxide of lead in potash is obtained by boiling finely powdered litharge in a solution of potash. In this solution is immersed a polished plate of silver or of German silver, which is connected with the positive electrode of a battery of eight Bunsen's elements. With the negative pole is connected a fine platinum wire fused in glass, so that only its point projects; and this is placed in the liquid at a small distance from the plate. Around this point binocide of lead is separated on the plate in very thin concentric layers, the thickness of which decreases from the middle. They show the same series of colours as Newton's coloured rings in transmitted light. The binocide of lead owes its origin to a secondary decomposition; by the passage of the current some oxide of lead is decomposed into metallic lead, which is deposited at the negative pole, and oxygen which is liberated at the positive; and this oxygen combines with some oxide of lead to form binocide, which is deposited on the positive pole as the decomposition proceeds.

The effects are also well seen if a solution of sulphate of copper is placed on a silver plate, which is touched with a zinc rod, the point of which is in the solution; for then a current is formed by these metals and the liquid.

**826. Arbor Saturni, or Lead tree. Arbor Dianæ.**—When, in a solution of a salt, is immersed a metal which is more oxidisable than the metal of the salt, the latter is precipitated by the former, while the immersed metal is substituted equivalent for equivalent for the metal of the salt. This precipitation of one metal by another is partly attributable to the difference in their affinities, and partly to the action of a current which is set up as soon as a portion of the less oxidisable metal has been deposited. The action is promoted by the presence of a slight excess of acid in the solution.

A remarkable instance of the precipitation of one metal by another is the *arbor Saturni*. This name is given to a series of brilliant ramified crystallisations obtained by zinc in solutions of acetate of lead. A glass flask is filled with a clear solution of this salt, and the vessel closed with a cork, to which is fixed a piece of zinc in contact with some copper wire. The flask, being closed, is left to itself. The copper wire at once begins to be covered with a moss-like growth of metallic lead, out of which brilliant

crystallised laminæ of the same metal continue to form ; the whole phenomenon has great resemblance to the growth of vegetation, from which indeed the old alchemical name is derived. For the same reason the name *arbor Dianæ* has been given to the metallic deposit produced in a similar manner by mercury in a solution of nitrate of silver.

#### ELECTROMETALLURGY.

827. **Electrometallurgy.**—The decomposition of salts by the battery has received a most important application in *electrometallurgy*, or *galvanoplastics*, by which is meant the art of precipitating certain metals from their solutions by the slow action of a galvanic current, by which means the salts of certain metals are decomposed, the metal being deposited on the negative pole, while the acid is liberated at the positive. The art was discovered independently by Spencer in England, and by Jacobi in Petersburg.

In order to obtain a galvanoplastic reproduction of a medal or any other object, a mould must first be made, on which the layer of metal is deposited by the electric current.

For this purpose several substances are in use, and one or the other is preferred according to circumstances. For medals and similar objects which can be submitted to pressure, gutta-percha may be used with advantage. The gutta-percha is softened in hot water, pressed against the object to be copied, and allowed to cool, when it can be detached without difficulty.

For the reproduction of engraved woodblocks or type, wax moulds are now commonly used. They are prepared by pouring into a narrow flat pan a suitable mixture of wax, tallow, and Venice turpentine, which is allowed to set, and is then carefully brushed over with very finely powdered graphite. While this composition is still somewhat soft, the woodblock or type is pressed upon it either by a screw press, or, still better, by hydraulic pressure. If plaster of Paris moulds are to be made use of, it is essential that they be first thoroughly saturated with wax or tallow so as to become impervious to water.

In all cases, whether the moulds be of gutta-percha, of wax, or any non-conducting substance, it is of the highest importance that their surface be brushed over very carefully with graphite, and so made a good conductor. The conducting surface thus prepared must also be in metallic contact with a wire or a strip of copper by which it is connected with the negative electrode.

Sometimes the moulds are made of a fusible alloy (327), which may consist of 5 parts of lead, 8 of bismuth, and 3 of tin. Some of the melted alloy is poured into a shallow box, and just as it begins to solidify the medal is placed horizontally on it in a fixed position. When the alloy has become cool, a slight shock is sufficient to detach the medal. A copper wire is then bound round the edge of the mould, by which it can be connected with the negative electrode of the battery, and then the edge and the back are covered with a thin non-conducting layer of wax, so that the deposit is only formed on the mould itself.

The most suitable arrangement for producing an electro-deposit of copper

consists of a trough of glass, slate, or of wood, lined with india-rubber or coated with marine glue (fig. 673). This contains an acid solution of sulphate of



Fig. 673.

copper, and across it are stretched copper rods B and D connected respectively with the negative and positive poles of a battery. By their copper conductors the moulds *m* are suspended in the liquid from the negative rod B, whilst a sheet of copper C, presenting a surface about equal to that of the moulds to be covered, is suspended from the positive rod D, at the distance of about 2 inches, directly opposite to them.

The battery employed for the electric deposition of metals ought to be one of great constancy, and Daniell's and Smee's are mostly in use. The currents of electricity furnished by magneto-electrical machines of a special construction are also used in large establishments.

The copper plate suspended from the positive pole serves a double purpose; it not only closes the current, but it keeps the solution in a state of concentration, for the acid liberated at the positive pole dissolves the copper, and reproduces a quantity of sulphate of copper equal to that decomposed by the current.

Another, and very simple process for producing the electric deposit of copper consists in making use of what is in effect a Daniell's cell. A porous pot, or a glass cylinder covered at the bottom with bladder, or with vegetable parchment, is immersed in a vessel of larger capacity containing a concentrated solution of sulphate of copper. The porous vessel contains acidulated water, and in it is suspended a piece of amalgamated zinc of suitable form: and having a surface about equal to that of the mould. The latter is attached to an insulated wire connected with the zinc, and is immersed in the solution of sulphate of copper in such a position that it is directly opposite to the diaphragm. The action commences by the mould becoming covered with copper, commencing at the point of contact with the conductor, and gradually increasing in thickness in proportion to the action of the Daniell's element thus formed. It is of course essential in the process to keep the solution of copper at a uniform strength, which is done by suspending in it muslin bags filled with crystals of sulphate of copper.

How great is the delicacy with which such electric deposits can attain

appears from the fact that galvanoplastic copies can be made of daguerreotypes, which are of the greatest accuracy.

828. **Electrogilding.**—The old method of gilding was by means of mercury. It was effected by an amalgam of gold and mercury, which was applied to the metal to be gilt. The objects thus covered were heated in a furnace, the mercury volatilised, and the gold remained in a very thin layer on the objects. The same process was used for silvering; but they were expensive and unhealthy methods, and have now been entirely replaced by electrogilding and electrosilvering. Electrogilding only differs from the process described in the previous paragraph in that the layer is thinner and adheres more firmly. Brugnatelli, a pupil of Volta, appears to have been the first, in 1803, to observe that a body could be gilded by means of the battery and an alkaline solution of gold; but De la Rive was the first who really used the battery in gilding. The methods both of gilding and silvering owe their present high state of perfection principally to the improvements of Elkington, Ruolz, and others.

The pieces to be gilt have to undergo three processes before gilding.

The first consists in heating them so as to remove the fatty matter which has adhered to them in previous processes.

As the objects to be gilt are usually of what is called *gilding metal* or red brass, and which is a special kind of brass rich in copper, and their surface during the operation of heating becomes covered with a layer of suboxide or of protoxide of copper, this is removed by the second operation. For this purpose the objects, while still hot, are immersed in very dilute nitric acid, where they remain until the oxide is removed. They are then rubbed with a hard brush, washed in distilled water, and dried in gently heated sawdust.

To remove all spots they must undergo the third process, which consists in rapidly immersing them in ordinary nitric acid, and then in a mixture of nitric acid, bay salt, and soot.

When thus prepared the objects are attached to the negative pole of a battery, consisting of three or four Bunsen's or Daniell's elements. They are then immersed in a bath of gold, as previously described. They remain in the bath for a time which depends on the thickness of the desired deposit. There is great difference in the composition of the baths. That most in use consists of 1 part of chloride of gold, 10 parts of cyanide of potassium, dissolved in 200 parts of water. In order to keep the bath in a state of concentration, a piece of gold is suspended from the positive electrode, which dissolves in proportion as the gold dissolved in the bath is deposited on the objects attached to the negative pole.

The method which has just been described can also be used for silver, bronze, German silver, etc. But other metals, such as iron, steel, zinc, tin, and lead, are very difficult to gilt well. To obtain a good coating, they must first be covered with a layer of copper, by means of the battery and a bath of sulphate of copper; the copper with which they are coated is then gilded, as in the previous case.

829. **Electrosilvering.**—What has been said about gilding applies exactly to the process of electrosilvering. The difference is in the composition of the bath, which consists of two parts of cyanide of silver, and two parts of cyanide of potassium dissolved in 250 parts of water. To the positive electrode is



suspended a plate of silver, which prevents the bath from becoming poorer : the pieces to be silvered, which must be well cleaned, are attached to the negative pole.

It may here be observed that these processes succeed best with hot solutions.

830. **Electric deposition of iron and nickel.**—One of the most valuable applications of the electric deposition of metals is to what is called the *steeling* (*acierage*) of engraved copper plates. The bath required for this purpose is obtained by suspending a large sheet of iron, connected with the positive pole of a battery, in a trough filled with a saturated solution of sal-ammoniac ; whilst a thin strip of iron, also immersed, is connected with the negative pole. By this means iron from the large plate is dissolved in the sal-ammoniac while hydrogen is given off on the surface of the small one. When the bath has thus taken up a sufficient quantity of iron, an engraved copper plate is substituted for the small negative strip. A bright deposit of iron begins to form on it at once, and the plate assumes the colour of a polished steel plate. The deposit thus obtained in the course of half an hour is exceedingly thin, and an impression of the plate thus covered does not seem different from an uncovered plate ; it possesses, however, an extraordinary degree of hardness, so that a very large number of impressions can be taken from such a plate before the thin coating of iron is worn off. When, however, this is the case, the film of iron is dissolved off by dilute nitric acid and the plate is again covered with the deposit of iron.

An indefinite number of perfect impressions may, by this means, be obtained from one copper plate, without altering the original sharp condition of the engraving.

The covering of metals by a deposit of nickel has of late come into use. The process is essentially the same as that just described. The bath used for the purpose can, however, be made more directly by mixing, in suitable proportions, salts of nickel with those of ammonia. The positive pole consists of a plate of pure nickel.

A special difficulty is met with in the electric deposition of nickel owing to the tendency of this metal to deposit in an uneven manner ; and then to become detached. This is got over by frequently removing the articles from the bath, and submitting them to a polishing process.

Objects coated with nickel show a highly polished surface of the characteristic bright colour of this metal. The coating is moreover very hard and durable, and is unaffected either by the atmosphere or even by sulphuretted hydrogen.

---

## CHAPTER IV.

## ELECTRODYNAMICS. ATTRACTION AND REPULSION OF CURRENTS BY CURRENTS.

831. **Electrodynamics.**—Under *electrodynamics* is understood the laws of electricity in a state of motion, or the action of electric currents upon each other and upon magnets, while *electrostatics* deals with the laws of electricity in a state of rest.

The action of one electrical current upon another was first investigated by Ampère, shortly after the discovery of Oersted's celebrated fundamental experiment (796). All the phenomena, even the most complicated, follow from two simple laws, which are—

I. *Two currents which are parallel, and in the same direction, attract one another.*

II. *Two currents parallel, but in contrary directions, repel one another.*

In order to demonstrate these laws, the circuit which the current traverses must consist of two parts, one fixed and the other movable. This is effected

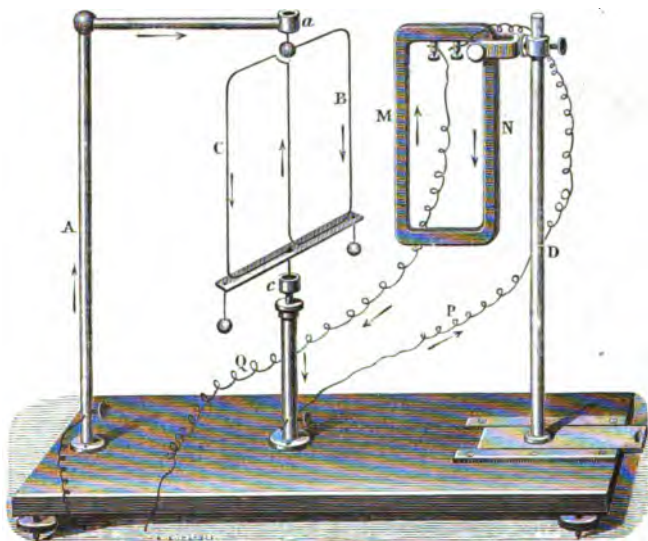

Fig. 674.

by the apparatus (fig. 674), which is a modified and improved form of one originally devised by Ampère.

It consists of two brass columns, A and D, between which is a shorter one. The column D is provided with a multiplier (797) of 20 turns, MN (fig. 674), which greatly increases the sensitiveness of the instrument. This can

be adjusted at any height, and in any position, by means of a universal screw clamp (see figs. 674, 676-680).

The short column is hollow, and in its interior slides a brass tube terminating in a mercury cup, *c*, which can be raised or lowered. On the column *A* is another mercury cup represented in section at fig. 675 in its natural size. In the bottom is a capillary aperture through which passes the point of a sewing needle fixed to a small copper ball. This point extends as far as the mercury, and turns freely in the hole. The movable part of the circuit consists of a copper wire proceeding from a small ball, and turning in the direction of the arrows from the cup *a* to the cup *c*. The two lower branches are fixed to a thin strip of wood, and the whole system is balanced by two copper balls suspended to the ends.

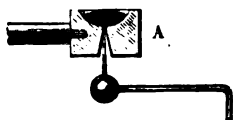

Fig. 675.

The details being known, the current of a Bunsen's battery of 4 or 5 cells ascending by the column *A* (fig. 674) to the cup *a*, traverses the circuit *BC*, reaches the cup *c*, descends the central column, and thence passes by a wire, *P*, to the multiplier *MN*, from whence it returns to the battery by the wire *Q*. Now if, before the current passes, the movable circuit has been arranged in the plane of the multiplier, with the sides *B* and *M* opposite each other, when the current passes, the side *B* is repelled, which demonstrates the second law; for in the branches *B* and *M* the currents, as indicated by the arrows, are proceeding in opposite directions.

To demonstrate the first law the experiment is arranged as in figure 676—that is, the multiplier is reversed; the current is then in the same direction both in the multiplier and in the movable part; and when the latter is removed out of the plane of the multiplier, so long as the current passes it tends to return to it, proving that there is attraction between the two parts.

832. **Rogee's vibrating spiral.**—The attraction of parallel currents may also be shown by an experiment known as that of *Rogee's vibrating spiral*. A copper wire about 0.7 mm. in diameter is coiled in a spiral of about 30 coils of 25 mm. diameter. At one end it is hung vertically from a binding screw, while the other just dips in a mercury cup. On passing the current of a battery of 3 to 5 Grove's cells through the spiral by means of the mercury cup and the binding screw, its coils are traversed by parallel currents; they therefore attract one another, and rise, and thus the contact with the mercury is broken. The current having thus ceased, the coils no longer attract each other, they fall by their own weight, contact with the mercury is re-established, and the series of phenomena are indefinitely produced. The experiment is still more striking if a magnetised rod the thickness of a pencil is introduced into the interior. This will be intelligible if we consider the action between the parallel Ampèrian currents of the magnet and of the helix.

833. **Laws of angular currents.**—I. *Two rectilinear currents, the directions of which form an angle with each other, attract one another when both approach, or recede from, the apex of the angle.*

11. *They repel one another, if one approaches and the other recedes from the apex of the angle.*

These two laws may be demonstrated by means of the apparatus above described, replacing the movable circuit by the circuit BC (fig. 677). If then the multiplier is placed horizontally, so that its current is in the same direc-

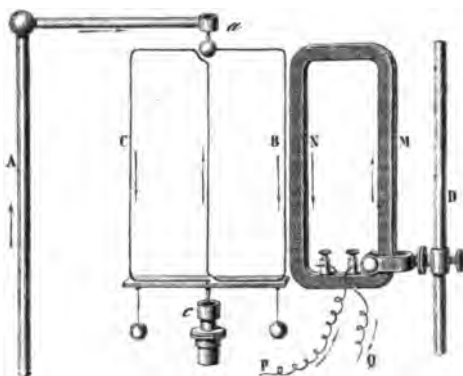

Fig. 676.

tion as in the movable current, if the latter is removed and the current passes so that the direction is the same as in the movable part, on removing the latter it quickly approaches the multiplier, which verifies the first law.

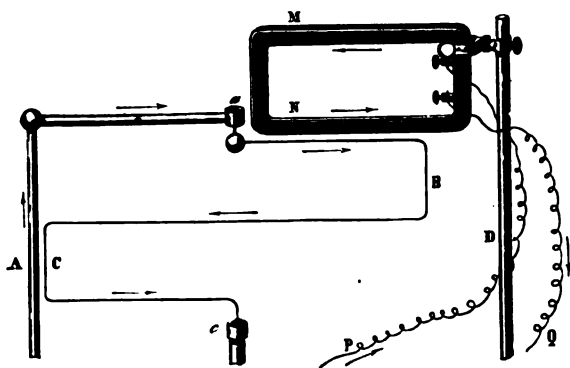

Fig. 677.

To prove the second law, the multiplier is turned so that the currents are in opposite directions, and then repulsion ensues (fig. 678).

*In a rectilinear current each element of the current repels the succeeding one, and is itself repelled.*

This is an important consequence of Ampère's law, and may be experimentally demonstrated by the following arrangement, which was devised by Faraday. A U-shaped piece of copper wire, whose ends dip in two separate deep mercury cups, is suspended from one end of a delicate balance and

suitably equipoised. When the mercury cups are connected with the two poles of a battery, the wire rises very appreciably, and sinks again to its

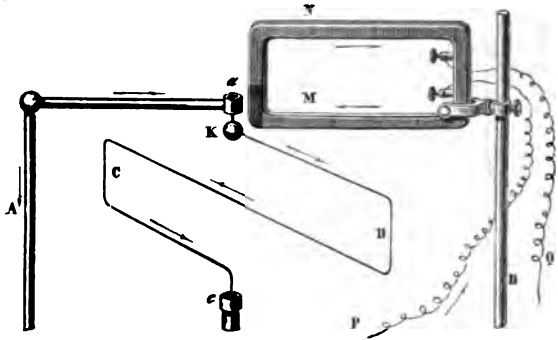

Fig. 678.

original position when the current ceases to pass. The current passes into the mercury and into the wire; but from the construction of the apparatus the former is fixed, while the latter is movable, and is accordingly repelled.

The repulsion may also be shown by means of the following experiment.

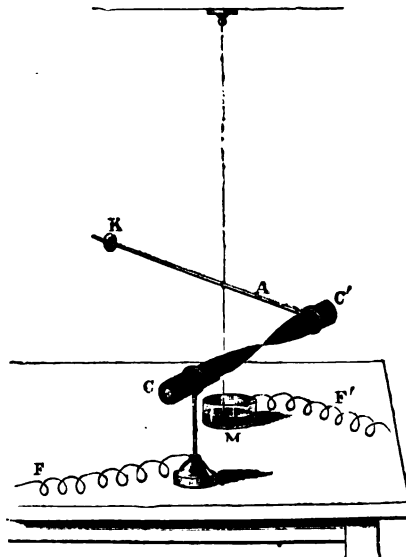

Fig. 679.

A rod of charcoal, C, drawn out to a fine point is fixed horizontally in a support. In contact with it is another similar pointed rod, C', counterpoised by the

weight  $K$  at the end of a light horizontal rod,  $A$ ; this rod is suspended by a wire, and is in metallic connection with a mercury cup  $M$ . If now  $C$  and  $C'$  be connected with the poles  $F$  and  $F'$  of a battery, the movable cone  $C'$  is repelled from  $C$ . As the wire thereby experiences some torsion, a stable equilibrium is established, and the point  $C'$  is kept at a fixed distance from  $C$ . At the same time the voltaic arc (809) is formed between  $C$  and  $C'$ .

834. **Laws of sinuous currents.**—*The action of a sinuous current is equal to that of a rectilinear current of the same length in projection.* This principle is demonstrated by arranging the multiplier vertically and placing

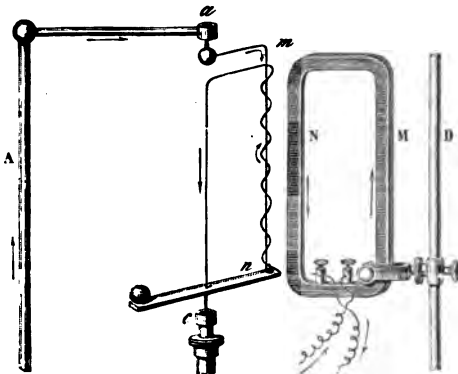

Fig. 680.

near it a movable circuit of insulated wire half sinuous and half rectilinear (fig. 680). It will be seen that there is neither attraction nor repulsion, showing that the action of the sinuous portion  $mu$  is equalled by that of the rectilinear portion.

An application of this principle will presently be met with in the apparatus called *solenoids* (847), which are formed of the combination of a sinuous with a rectilinear current.

#### DIRECTION OF CURRENTS BY CURRENTS.

835. **Action of an infinite current on a current perpendicular to its direction.**—From the action exerted between two angular currents (833) the action of a fixed and infinite rectilinear current,  $PQ$  (fig. 681), on a movable current,  $KH$ , perpendicular to its direction, can be determined. Let  $OK$  be the perpendicular common to  $KH$  and  $PQ$ , which is null if the two lines  $PQ$  and  $KH$  meet. The current  $PQ$  flowing from  $Q$  to  $P$  in the direction of the arrows, let us first consider the case in which the current  $KH$  approaches the current  $QP$ . From the first law of angular currents (833) the portion  $QO$  of the current  $PQ$  attracts the current  $KH$ , because they both flow towards the summit of the angle formed by their directions. The portion  $PO$ , on the contrary, will repel the current  $KH$ , for here the two currents are in opposite directions at the summit of the angle. If then  $mq$  and  $mp$  stand for the two

forces, one attractive and the other repulsive, which act on the current  $KH$ , and which are necessarily of the same intensity, since they are symmetrically arranged in reference to the two sides of the point  $O$ , these two forces may

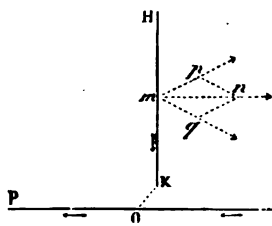

Fig. 681.

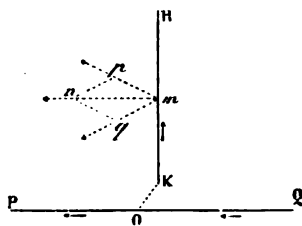

Fig. 682.

be resolved into a single force,  $mn$ , which tends to move the current  $KH$  parallel to the current  $QP$ , but in a contrary direction.

A little consideration will show that when the current  $KH$  is below the current  $PQ$ , its action will be the opposite of what it is when above.

On considering the case in which the current  $KH$  moves away from  $PQ$  (fig. 682), it will be readily seen from similar considerations that it moves parallel to this current, but in the same direction.

Hence follows this general principle. *A finite movable current which approaches a fixed infinite current is acted on so as to move in a direction parallel and opposite to that of the fixed current; if the movable current tends from the fixed current, it is acted on so as to move parallel to the current and in the same direction.*

It follows from this, that if a vertical current is movable about an axis,  $XY$ , parallel to its direction (figs. 683 and 684), any horizontal current,  $PQ$ ,

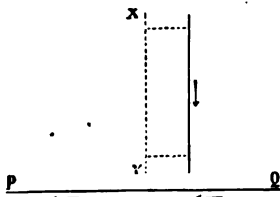

Fig. 683.

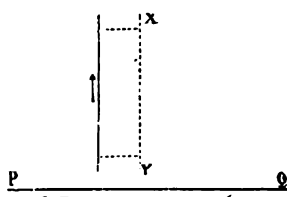

Fig. 684.

will have the effect of turning the movable current about its axis, *until the plane of the axis and of the current have become parallel to  $PQ$* ; the vertical current stopping, in reference to its axis, *on the side from which the current  $PQ$  comes* (fig. 683), *or on the side towards which it is directed* (fig. 684), *according as the vertical current descends or ascends*—that is, according as it approaches or moves from the horizontal axis.

It also follows from this principle that a system of two vertical currents rotating about a vertical axis (fig. 685 and 686) is directed by a horizontal current,  $PQ$ , in a plane parallel to this current, when one of the vertical

currents is ascending and the other descending (fig. 685); but that if they are both ascending or both descending (fig. 686), they are not directed.

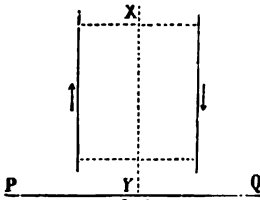

Fig. 685.

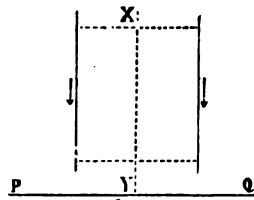

Fig. 686

836. **Action of an infinite rectilinear current on a rectangular or circular current.**—It is easy to see that a horizontal infinite current exercises the same directive action on a rectangular current movable about a vertical axis (fig. 687) as what has been above stated. For, from the direction of the currents indicated by the arrows, the part QY acts by attraction not only on the horizontal portion YD (*law of angular currents*), but also on the vertical portion AD (*law of perpendicular currents*). The same action evidently takes place between the part PY and the parts CY and BC. Hence, *the fixed current PQ tends to direct the movable rectangular current ABCD into a position parallel to PQ, and such that in the wires CD and PQ the direction of the two currents is the same.*

This principle is readily demonstrated by placing the circuit ABCD on the apparatus with two supports (fig. 687), so that at first it makes an angle

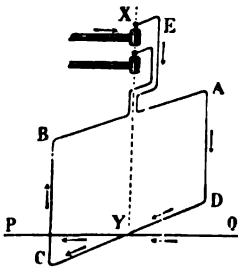

Fig. 687.

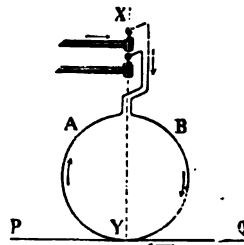

Fig. 688.

with the plane of the supports. On passing below the circuit, a somewhat powerful current in the same plane as the supports, the movable part passes into that plane. It is best to use the circuit in fig. 695, which is astatic, while that of fig. 687 is not.

What has been said about the rectangular current in fig. 687 applies also to the circular current of fig. 688, and is demonstrated by the same experiments.



## ROTATION OF CURRENTS BY CURRENTS.

837. **Rotation of a finite horizontal current by an infinite horizontal rectilinear current.**—The attractions and repulsions which rectangular currents exert on one another may readily be transformed into a continuous circular motion. Let  $OA$  (fig. 689) be a current movable about the point  $O$  in a horizontal plane, and let  $PQ$  be a fixed infinite current also horizontal. As these two currents flow in the direction of the arrows, it follows that in

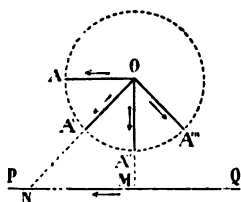

Fig. 689.

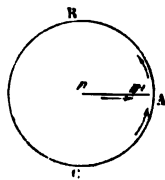

Fig. 690.

the position  $OA$ , the movable current is attracted by the current  $PQ$ , for they are in the same direction. Having reached the position  $OA'$ , the movable current is attracted by the part  $NQ$  of the fixed current, and repelled by the part  $PN$ . Similarly, in the position  $OA''$ , it is attracted by  $MQ$  and repelled by  $PM$ , and so on; from which follows a continuous rotatory motion in the direction  $AA'A''A'''$ . If the movable current, instead of being directed from  $O$  towards  $A$ , were directed from  $A$  towards  $O$ , it is easy to see that the rotation would take place in the contrary direction. Hence, by the action of a fixed infinite current,  $PQ$ , the movable current  $OA$  tends to a continuous motion *in a direction opposite that of the fixed current*.

If, both currents being horizontal, the fixed current were circular instead of being rectilinear, its effect would still be to produce a continuous circular motion. For, let  $ABC$  (fig. 690) be a fixed circular current, and  $mn$  a rectilinear current movable about the axis  $n$ , both currents being horizontal. These currents, flowing in the direction of the arrows, would attract one another in the angle  $nAC$ , for they both flow towards the summit (833). In the angle  $nAB$ , on the contrary, they repel one another, for one goes towards the summit and the other moves from it. Both effects coincide in moving the wire  $mn$  in the same direction  $ACB$ .

838. **Rotation of a vertical current by a horizontal circular current.**—A horizontal circular current, acting on a rectilinear vertical also imparts to it a continuous rotatory motion. In order to show this, the apparatus represented in fig. 691 is used.

It consists of a brass vessel, round which are rolled several coils of insulated copper wire, through which a current passes. In the centre of the vessel is a brass support,  $a$ , terminated by a small cup containing mercury. In this dips a pivot supporting a copper wire,  $bb$ , bent at its ends in two vertical branches, which are soldered to a very light copper ring immersed in acidulated water contained in the vessel. A current entering through the

wire *m*, reaches the wire A, and having made several circuits, terminates at B, which is connected by a wire underneath with the lower part of the column *a*. Ascending in this column, it passes by the wires *bb* into the copper ring, into the acidulated water, and into the sides of the vessel, whence it returns to the battery by the strip D. The current being thus closed, the circuit *bb* and the ring tend to turn in a direction contrary to that of the fixed current, a motion due to the action of the circular current on the current in the vertical branches *bb*; for, as follows from the two laws of angular currents, the branch *b* on the right is attracted by the portion A of the fixed current, and

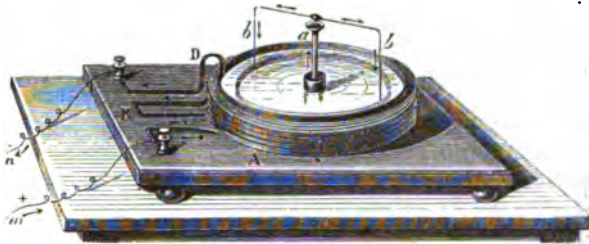

Fig. 691.

the branch *b* on the left is attracted in the contrary direction by the opposite part, and these two motions coincide in giving the ring a continuous rotatory motion in the same direction. The action of the circular current on the horizontal part of the circuit *bb* would tend to turn it in the same direction; but from its distance it may evidently be neglected.

839. **Rotation of magnets by currents.**—Faraday has proved that currents impart the same rotatory motions to magnets which they do to

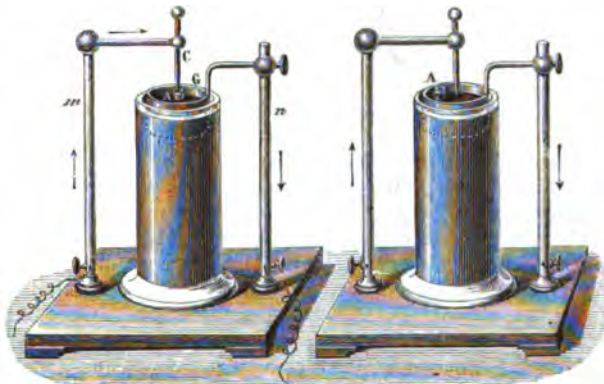

Fig. 692.

Fig. 692a.

currents. This may be shown by means of the apparatus represented in fig. 692. It consists of a large glass vessel, almost filled with mercury. In the centre of this is immersed a magnet A about 8 inches in length, which pro-

jects a little above the surface of the mercury, and is loaded at the bottom with a platinum cylinder. At the top of the magnet is a small cavity containing mercury; the current ascending the column  $m$  passes into this cavity by the rod  $C$ . From the magnet it passes by the mercury to a copper ring  $G$ , whence it emerges by the column  $n$ . When this takes place the magnet begins to rotate round its own axis with a velocity depending on its magnetic power and on the intensity of the current.

Instead of making the magnet rotate on its axis, it may be caused to rotate round a line parallel to its axis by arranging the experiment as shown in fig. 692.

This rotatory motion is readily intelligible on Ampère's theory of magnetism, which will be subsequently explained (852), according to which, magnets are traversed on their surface by an infinity of circular currents in the same direction, in planes perpendicular to the axis of the magnet. At the moment at which the current passes from the magnet into the mercury, it is divided on the surface of the mercury into an infinity of rectilinear currents proceeding from the axis of the magnet to the circumference of the glass. Figs. 693 and 694, which correspond respectively to figs. 692 and 692a, give on a larger scale, and on a horizontal plane passing through the surface of the mercury, the direction of the currents to which the rotation is due. In figure 692 the north pole being at the top, the Ampèrian currents pass

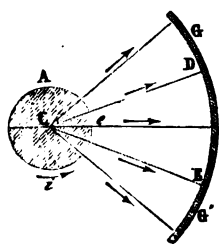

Fig. 693.

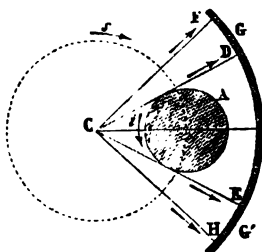

Fig. 694.

round the magnet in the reverse direction to that of the hands of a watch, as indicated by the arrow  $i$  (852), while the currents which radiate from the rod  $C$  towards the metal ring  $GG$ , have the direction  $CD$ ,  $CE$ . Hence (833) any given element  $e$  of the magnetic current of the bar  $A$  is attracted by the current  $CE$  and repelled by the current  $CD$ ; hence results a rotation of the bar about its axis in the same direction as the hands of a watch.

In fig. 694 the currents  $CD$ ,  $CE$  being in the opposite direction to those of the bar would repel the latter, which would be attracted by the currents  $CE$ ,  $CA$ . Hence the bar rotates in a circular direction, shown by the arrow  $s$ , about the vertical axis which passes through the rod  $C$ .

If the north pole is below, or if the direction of the current be altered, the rotation of the magnet is in the opposite direction.

## ACTION OF THE EARTH AND OF MAGNETS ON CURRENTS.

840. **Directive action of magnets on currents.**—Not only do currents act upon magnets, but magnets also act upon currents: In Oersted's fundamental experiment (fig. 643), the magnet being movable while the current is fixed, the former is directed and sets at right angles with the current. If, on the contrary, the magnet is fixed and the current movable, the latter is directed and sets across the direction of the magnet. This may be illustrated by the apparatus represented in fig. 695. This is the original form of

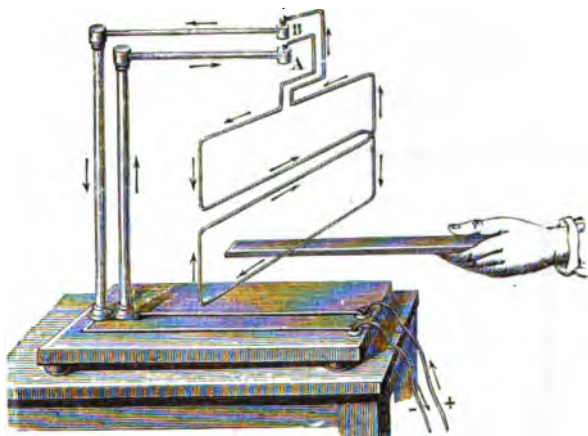

Fig. 695.

Ampère's stand, and is frequently used in experimental demonstration. It needs no explanation. The circuit which the current traverses is movable, and below its lower branch a powerful bar magnet is placed; the circuit immediately begins to turn, and stops after some oscillations in a plane perpendicular to the axis of the magnet.

For demonstrating the action of magnets upon currents, and indeed for establishing the fundamental laws of electrodynamics, a small apparatus, known as De la Rive's *floating battery*, is well adapted. It consists of a small Daniell's element, contained in a glass tube attached to a cork, so that it can float freely on water. The plates are connected with minute mercury cups on the cork float; and with these can be connected either circular or rectangular wires, coils, or solenoids; they are then traversed by a current, and can be subjected to the action either of magnets or of currents.

841. **Rotation of currents by magnets.**—Not merely can currents be directed by magnets, but they may also be made to rotate, as is seen from the following experiment, devised by Faraday, fig. 696. On a base with levelling screws, and resting on an ivory support, is a copper rod, BD. It is surrounded in part of its length by a magnetised bundle, AB, and at the

K K

top is a mercury cup. A copper circuit, EF, balanced on a steel point, rests in the cup, and the other ends of the circuit, which terminate in steel points, dip in an annular reservoir full of mercury.

The apparatus being thus arranged, the current from 4 or 5 Bunsen's elements enters at the binding screw *b*: it thence ascends in the rod, D, re-descends by the two branches, reaches the mercury by the steel points, whence it passes by the framework, which is of copper, to the battery by the binding screw *a*. If now the magnetised bundle be raised, the circuit EF rotates, either in one direction or the other, according to the pole by which it is influenced. This rotation is due to currents assumed to circulate round magnets, currents which act on the vertical branches EF in the same way as the circular current on the arm in fig. 691.

In this experiment the magnetised bundle may be replaced by a solenoid (847) or by an electromagnet, in which case the two binding screws in the base of the apparatus on the left give entrance to the current which is to traverse the solenoid or electromagnet.

842. **Electrodynamic and electromagnetic rotation of liquids.**—In the experiments hitherto discussed rotation is produced by causing a fixed current

to act upon a movable linear current. The condition of a linear current is not necessary. Fig. 697 represents an apparatus devised by Bertin to show the electrodynamic and electromagnetic rotation of liquids. This apparatus consists of an annular earthen vessel, VV; that is to say, it is open in the centre so as to be traversed by a coil, H. This rests on a board which can be raised along two columns, E and I, and which are fixed by means of the screws KK. Round the vessel VV is a second larger coil, G, fixed on the columns SS'. The vessel VV rests on the lower plane. In the centre of the coil, there is a bar of soft iron, *x*, which makes an electromagnet.

The vessel VV contains acidulated water, and in the liquid are plunged two cylindrical copper plates, *e* and *i*, soldered to copper wires, *e'* and *i'*, which convey the current of a battery of four couples through the rods E and I.

The whole system is arranged on a larger base, on the left of which is a commutator represented afterwards on a larger scale (fig. 698). With the base of the columns E, I, S and S', are connected four copper strips, three

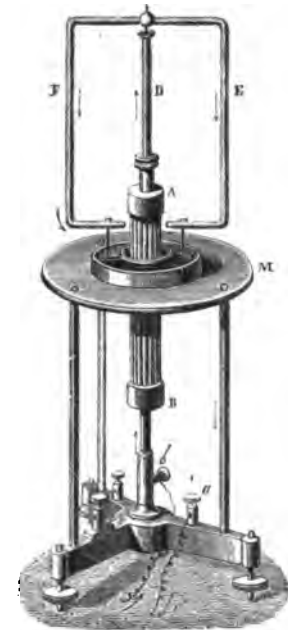

Fig. 696.

of which lead to the commutator and the fourth to the binding screw A, which receives the wire from the positive pole.

These details being premised, the following three effects may be obtained with this apparatus:—(1), the action of the coil G alone; (2), the action of

the electromagnet H alone ; (3), the simultaneous action of the coil and of the electromagnet.

I. Fig. 697 represents the apparatus arranged for the first effect. The current coming by the binding screw A attains the column S', which leads it to the coil G, with regard to which it is *left*—that is, in a contrary direction to the hands of a watch. Then descending by the column S, it reaches the

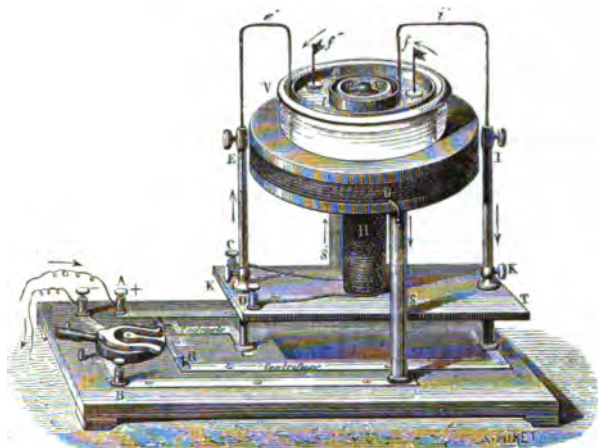

Fig. 697.

commutator, which leads it by the plate marked *centripete* to the column E and to the electrode *e*. The current here traverses the liquid from the circumference to the centre, attains the electrode *i*, the column I, and by the intervention of the plate *centrifuge* the central piece of the commutator. This transmits it finally to the negative binding screw, which leads it to the battery. The liquid then commences a *direct* rotatory motion—that is to say, in the same direction as the coil.

If the direction of the current in the liquid is *centrifugal*—that is, proceeds from the centre to the circumference—the rotation is *inverse* ; that is, is in the opposite direction to that of the coil. In both cases the rotations may be shown to those at a distance by means of small flags, *f, f*, fixed on discs of cork which float on the liquid, and which are coated with lampblack to prevent adherence by capillary attraction between the discs and the electrodes *e* and *i*.

II. To experiment with the electromagnet alone, the positive wire of the battery is joined with the binding screw C, and the binding screws D and B are joined by a copper wire. The current first passes into the electromagnet H, then, reaching the commutator by the binding screw B, passes into the centripetal plate, whence it rises in the column E, traverses the liquid in the same direction as at first, reascends by the column I, and from thence to the centre of the commutator and the negative binding screw which leads it to the battery.

If the north pole of the electromagnet is at the same height as the glass

vessel, as in the figure, the Ampèrian currents move in the opposite direction to the hands of a watch, and the floats then move in the same direction as above; and if the electromagnet is raised until the neutral line is at the same height as the vessel, the floats stop; if it is above them, the floats move again, but in the opposite direction.

III. To cause the coil and the electromagnet to act simultaneously, the positive wire of the battery is attached at C, and the binding screws D and A are connected by a conductor. Hence, after having traversed the coil H, the current arrives from D, and the binding screw A, whence it traverses exactly the same circuit as in the first experiments. The effects are the same, though more intense; the action of the coil and the electro-magnet being in the same direction.

843. **Bertin's commutator.**—*Commutators* are apparatus by which the direction of currents may be changed at pleasure, or by which they may be opened or closed. Bertin's has the advantage of at once showing the direction of the current. It consists of a small base of hard wood on which is an ebonite plate, which, by means of the handle *m* (fig. 698), is turned about a

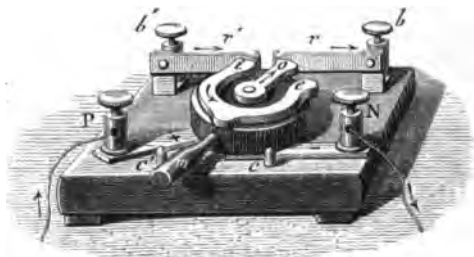

Fig. 693.

central axis, between two stops, *c* and *c'*. On the disc are fixed two copper plates, one of which *o* is always positive, being connected by the axis and by a plate, +, with the binding screw P, which receives the positive electrode of the battery; the other, *i e*, bent in the form of a horse-shoe, is connected by friction below the disc with a plate— which passes to the negative electrode N. On the opposite side of the board are two binding screws, *b* and *b'*, to which are adapted two elastic metal plates, *r* and *r'*.

These details being premised, the disc being turned as shown in the figure, the current coming by the binding screw P passes into the piece *o*, the plate *r* and the binding screw *b*, which by a second plate, or by a copper wire, leads it to the apparatus of fig. 697, or any other. Then returning to the binding screw *b'*, the current attains the plate *r'*, the piece *i e*, and ultimately the binding screw N, which returns it to the battery.

If the disc is turned so that the handle is half-way between *c* and *c'*, the pieces *o* and *i e* being no longer in contact with the plates *r* and *r'*, the current does not pass. If *m* is turned as far as *c*, the plate *o* touches *r'*, the current thus passes first to *b'* and returns by *b*; it is therefore reversed.

844. **Directive action of the earth on vertical currents.**—The earth, which exercises a directive action on magnets (671), acts also upon currents,

giving them, in some cases, a fixed direction, in others a continuous rotatory motion, according as their currents are arranged in a vertical or horizontal direction.

The first of these two actions may be thus enunciated: *Every vertical current movable about an axis parallel to itself, places itself under the directive action of the earth in a plane through this axis perpendicular to the magnetic meridian, and stops, after some oscillations, on the east of its axis of rotation when it is descending, and on the west when it is ascending.*

This may be demonstrated by means of the apparatus represented in fig. 700, which consists of two brass vessels of somewhat different diameters

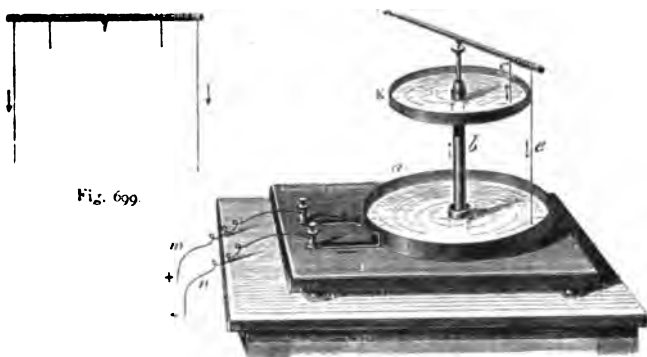

Fig. 700

The larger, *a*, about 13 inches in diameter, has an aperture in the centre, through which passes a brass support, *b*, insulated from the vessel *a*, but communicating with the vessel *K*. This column terminates in a small cup, in which a light wooden rod rests on a pivot. At one end of this rod a fine wire is coiled, each end of which dips in acidulated water, with which the two vessels are respectively filled.

The current arriving by the wire *m* passes to a strip of copper, which is connected underneath the base of the apparatus with the bottom of the column *b*. Ascending in this column, the current reaches the vessel *K*, and the acidulated water which it contains; it ascends from thence in the wire *c*, redescends by the wire *e*, and traversing the acidulated water, it reaches the sides of the vessel *a*, and so back to the battery through the wire *n*.

The current being thus closed, the wire *e* moves round the column *b*, and stops to the east of it, when it descends, as is the case in the figure; but if it ascends, which is effected by transmitting the current by the wire *n*, the wire *e* stops to the west of the column *b*, in a position directly opposite to that which it assumes when it is descending.

If the rod with a single wire, in fig. 700, be replaced by one with two wires, as in fig. 699, the rod will not move, for as each wire tends to place itself on the east of the column *b*, two equal and contrary effects are produced, which counterbalance one another.



845. **Action of the earth on horizontal currents movable about a vertical axis.**—The action of the earth on horizontal currents is not directive, but *gives them a continuous rotatory motion from the east to the west when the horizontal current moves away from the axis of rotation, and from the west to the east when it is directed towards this axis.*

This may be illustrated by means of the apparatus represented in fig. 701, which only differs from that of fig. 700 in having but one vessel. The



Fig. 701.

current ascending by the column *a*, traverses the two wires *cc*, and descends by the wires *bb*, from which it regains the pile; the circuit *bccb* then begins a continuous rotation, either from the east to the west, or from the west to the east, according as in the wires *cc* the current goes from the centre, as is the case in the figure; or according as it goes towards it, which is the case when the current enters by the wire *m* instead of by *n*. But we have seen (844) that the action of the earth on the vertical wires *bb* is destroyed: hence the rotation is that produced by the action on the horizontal branches *cc*. This rotatory action of the terrestrial current on horizontal currents is a consequence of the rotation of a finite horizontal by an infinite horizontal current (837).

846. **Directive action of the earth on closed currents movable about a vertical axis.**—If the current on which the earth acts is closed, whether it be rectangular or circular, the result is not a continuous rotation, but a directive action, as in the case of vertical currents (844), in virtue of which *the current places itself in a plane perpendicular to the magnetic meridian, so that, for an observer looking at the north, it is descending on the east of its axis of rotation, and ascending on the west.*

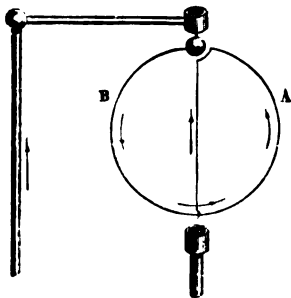

Fig. 702.

This property, which can be shown by means of the apparatus represented in fig. 702, is a consequence of what has been said about horizontal and vertical currents. For in the closed circuit *BA*, the current in the upper and lower parts tends to turn in opposite directions, from the law of horizontal

currents (845); and hence is in equilibrium, while in the lateral parts the current on the one side tends towards the east, and on the other side to the west, from the law of vertical currents (844).

From the directive action of the earth on currents, it is necessary, in most experiments, to obviate this action. This is effected by arranging the movable circuit symmetrically about its axis of rotation, so that the directive action of the earth tends to turn them in opposite directions, and hence destroys them. This condition is fulfilled in the circuit in fig. 695. Such circuits are hence called *astatic circuits*.

## SOLENOIDS.

847. **Structure of a solenoid.**—A solenoid is a system of equal and parallel circular currents formed of the same piece of covered copper wire, and coiled in the form of a helix or spiral, as represented in fig. 703. A solenoid however, is only complete when part of the wire BC passes in the direction of the axis in the interior of the helix. With this arrangement, when the circuit is traversed by a current, it follows from what has been said about sinuous currents (805) that the action of a solenoid in a longitudinal direction, AB, is counterbalanced by that of the rectilinear current BC. This action is accordingly null in the direction of the length, and the *action of a solenoid in a direction perpendicular to its axis is exactly equivalent to that of a series of equal parallel currents*.



Fig. 703.

848. **Action of currents on solenoids.**—What has been said of the action of fixed rectilinear currents on finite rectangular or circular currents (837), applies evidently to each of the circuits of a solenoid, and hence a

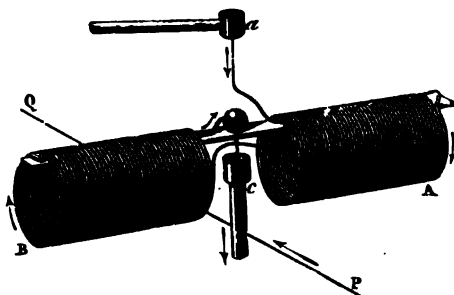

Fig. 704.

rectilinear current must tend to direct these circuits parallel to itself. To demonstrate this fact experimentally, a solenoid is constructed as shown in fig. 704, so that it can be suspended by two pivots in the cups *a* and *c* of the apparatus represented in fig. 695. The solenoid is then movable about a vertical axis, and if beneath it a rectilinear current QP be passed, which at the same time traverses the wires of the solenoid, the latter is seen to turn and set at right angles to the lower current—that is, in such a position that its circuits are parallel to the fixed current; and, further, in the lower part

of each of the circuits the current is in the same direction as in the rectilinear wire.

If, instead of passing a rectilinear current below the solenoid, it is passed vertically on the side, an attraction or repulsion will take place, according as in the vertical wire, and in the nearest part of the solenoid, the two currents are in the same or in contrary directions.

849. **Directive action of the earth on solenoids.**—If a solenoid be suspended in the two cups (fig. 695), not in the direction of the magnetic meridian, and a current be passed through the solenoid, the latter will begin to move, and will finally set in such a position that its axis is in the direction of the magnetic meridian. If the solenoid be removed, it will after a few oscillations, return, so that its axis is in the magnetic meridian. Further, it will be found that in the lower half of the coils of which the solenoid consists, the direction of the current is from east to west; in other words, the current is *descending* on that side of the coil turned towards the east and *ascending* on the west. The directive action of the earth on solenoids is accordingly a consequence of that which it exerts on circular currents. In this experiment the solenoid is directed like a magnetic needle, and the *north pole*, as in magnets, is that end which points towards the north, and the *south pole* that which points towards the south. This experiment may be well made by means of a solenoid fitted on a De la Rive's floating battery.

850. **Mutual action of magnets and solenoids.**—Exactly the same phenomena of attraction and repulsion exist between solenoids and magnets as between magnets themselves. For if to a movable solenoid, traversed by a current, one of the poles of a magnet be presented, attraction or repulsion will take place, according as the poles of the magnet and of the solenoid are of contrary or of the same name. The same phenomenon takes place when a solenoid traversed by a current and held in the hand is presented to a movable magnetic needle. Hence the law of attractions and repulsions applies exactly to the case of the mutual action of solenoids and of magnets.

851. **Mutual actions of solenoids.**—When two solenoids traversed by a powerful current are allowed to act on each other one of them being held

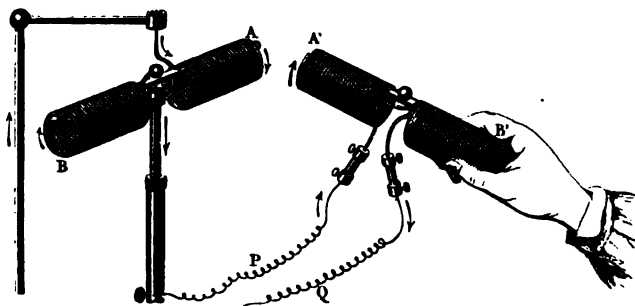

Fig. 705.

in the hand, and the other being movable about a vertical axis, as shown in fig. 705, attraction and repulsion will take place just as in the case of two

magnets. These phenomena are readily explained by reference to what has been said about the mutual action of the currents, bearing in mind the direction of the currents in the extremities presented to each other.

852. **Ampère's theory of magnetism.**—Ampère has propounded an ingenious theory, based on the analogy which exists between solenoids and magnets, by which all magnetic phenomena may be referred to electro-dynamical principles.

Instead of attributing magnetic phenomena to the existence of two fluids, Ampère assumes that each individual molecule of a magnetic substance is traversed by a closed electric current. It is further assumed that these molecular currents are free to move about their centres. The coercive force however, which is little or nothing in soft iron, but considerable in steel, opposes this motion, and tends to keep them in any position in which they happen to be. When the magnetic substance is not magnetised, these molecular currents, under the influence of their mutual attractions, occupy such positions that their total action on any external substance is null. Magnetisation consists in giving to these molecular currents a parallel direction, and the stronger the magnetising force the more perfect the parallelism. The *limit of magnetisation* is attained when the currents are completely parallel.

The resultant of the actions of all the molecular currents is equivalent to that of a single current which traverses the outside of a magnet. For by inspection of fig. 706 in which the molecular currents are represented by a series of small internal circles in the two ends of a cylindrical bar, it will be seen that the adjacent parts of the currents oppose one another and cannot exercise any external electrodynamic action. This is not the case with the surface; there the molecular currents at *ab* are not neutralised by other currents, and as the points *abc* are infinitely near, they form a series of elements in the same direction situated in planes perpendicular to the axis of the magnet, and which constitute a true solenoid.

The direction of these currents in magnets can be ascertained by considering the suspended solenoid (fig. 704). If we suppose it traversed by a current, and in equilibrium in the magnetic meridian, it will set in such a position that in the lower half of each coil the current flows from east to west. We may then establish the following rule. *At the north pole of magnet, the direction of the Ampèrian currents is opposite that of the hands of a watch, and at the south pole the direction is the same as that of the hands.*

853. **Terrestrial current.**—In order to explain on this supposition terrestrial magnetic effects, the existence of electrical currents is assumed, which continually circulate round our globe from east to west perpendicular to the magnetic meridian.

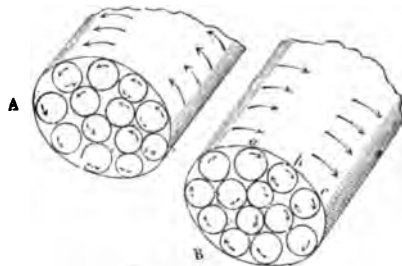

Fig. 706.

The resultant of their action is a single current traversing the magnetic equator from east to west. These currents are supposed to be thermoelectric currents due to the variations of temperature caused by the successive influence of the sun on the different parts of the globe from east to west.

These currents direct magnetic needles; for a suspended magnetic needle comes to rest when the molecular currents on its under surface are parallel, and in the same direction as the terrestrial currents. As the molecular currents are at right angles to the direction of its length, the needle places its greatest length at right angles to east and west, or north and south. Natural magnetisation is probably imparted in the same way to iron minerals.

## CHAPTER V.

### MAGNETISATION BY CURRENTS. ELECTROMAGNETS. ELECTRIC TELEGRAPHS.

854. **Magnetisation by currents.**—From the influence which currents exert upon magnets, turning the north pole to the left and the south pole to the right, it is natural to think that by acting upon magnetic substances in the natural state the currents would tend to separate the two magnetisms. In fact when a wire traversed by a current is immersed in iron filings, they adhere to it in large quantities, but become detached as soon as the current ceases, while there is no action on any other non-magnetic metal.

The action of currents on magnetic substances is well seen in an experiment due to Ampère, which consists in coiling an insulated copper wire round a glass tube, in which there is an unmagnetised steel bar. If a current be passed through the wire, even for a short time, the bar becomes strongly magnetised.

If, as we have already seen, the discharge of a Leyden jar be transmitted through the wire, by connecting one end with the outer coating, and the



Fig. 707.

other with the inner coating, the bar is also magnetised. Hence both voltaic and frictional electricity can be used for magnetising.

If in this experiment the wire be coiled on the tube in such a manner that when it is held vertically the downward direction of the coils is from right to left on the side next the observer, this constitutes a *right-handed* or *dextrorsal spiral* or *helix* (fig. 707), of which the ordinary screw is an example.



Fig. 708.

In a *left-handed* or *sinistrorsal helix* the coiling is in the opposite direction, that is from left to right (fig. 708).

In a right-handed spiral the north pole is at the end at which the current emerges, and the south pole at the end at which it enters ; the reverse is the case in a left-handed spiral. But whatever the direction of the coiling, the polarity is easily found by the following rule : *If a person swimming in the current look at the axis of the spiral the north pole is always on his left.*

If the wire be not coiled regularly, but if its direction be reversed, at each change of direction a consequent pole (663) is formed in the magnet. The simplest method of remembering the polarity produced is as follows : Whatever be the nature of the helix, either right or left handed, if the end facing the observer has the current flowing in the direction of the hands of a watch, it is a *south* pole and *vice versa*. The same polarity is produced, whether or not there is an iron core within the helix.

The nature of the tube on which the helix is coiled is not without influence. Wood and glass have no effect, but a thick cylinder of copper may greatly affect the action of the current unless the copper be slit longitudinally. This action will be subsequently explained. The same is the case with iron, silver, and tin.

In order to magnetise a steel bar by means of electricity, it need not be placed in a tube, as shown in figs. 707 and 708. It is sufficient to coil round

it a copper wire covered with silk, cotton, or gutta-percha in order to insulate the circuits from one another. The action of the current is thus multiplied, and a feeble current is sufficient to produce a powerful magnetising effect.

855. **Electromagnets.**—*Electromagnets* are bars of soft iron which, under the influence of a voltaic current, become magnets ; but this magnetism is only temporary, for the coercive force of perfectly soft iron is null, and the two magnetisms neutralise each other as soon as the current ceases to pass through the wire. If, however, the iron is not quite pure it retains more or less traces of magnetism. Electromagnets have the horse-shoe form, as shown in fig. 709, and a copper wire, covered with silk or cotton, is rolled several times round them on the two branches, so as to form two bobbins, A and B. In order that the two ends of the horse-shoe may be of opposite polarity, the winding on the two limbs A and B must be such that if the horse-shoe were straightened out, it would be in the same direction.]

Electromagnets, instead of being made in one piece, are frequently constructed of two cylinders, firmly screwed to a stout piece of the same metal. Such are the electromagnets in Morse's telegraph (859), the electromagnetic motor (867). The helices on them must be such that the current shall flow

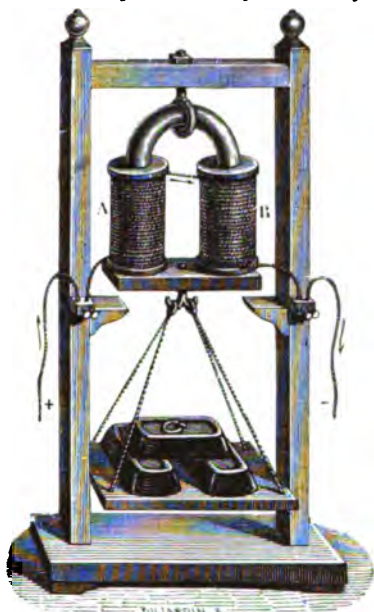

Fig. 709. .

in the same direction as the hands of a watch as seen from the south pole and against the hands of a watch as seen from the north pole.

The results at which various experimenters have arrived as regards the force of electromagnets are often greatly divergent, which is partly due to the different senses they have attached to the notion of *electromagnetic force*. For this may mean (I.) the induction current which the development and disappearance of the magnetism of an iron core indicate in a spiral which surrounds it; this is the *excited magnetism*: or (II.) the free magnetism measured by the action on a magnetic needle, oscillating at a distance; (III.) the *attractive force*, or the force required to hold an armature at a distance from the electromagnet; (IV.) the *lifting power* measured by the force with which an armature is held in direct contact with the pole.

The most important results which have been arrived at are the following:

(i.) Using the term electromagnetic force in the first two senses, it is *proportional to the intensity of the current*. This only applies when the currents are not very powerful, and to stout bars; for in each bar there is, as Muller has found, a maximum of magnetisation which cannot be exceeded.

(ii.) Taking into account the resistance, *the electromagnetic force is independent of the nature and thickness of the wire*. Thus, the intensity of the current and the number of coils being the same, thick and thin wires produce the same effect.

(iii.) With the same current *the electromagnetic force is independent of the width of the coils*, provided the iron projects beyond the coils, and the diameter of the coil is small compared with its length.

(iv.) The temporary magnetic moment *of an iron bar is within certain limits proportional to the number of windings*. The product of the intensity into the number of turns is usually spoken of as the *magnetising power* of the spiral. The greatest magnetising power is obtained when the resistance in the magnetising spiral is equal to the sum of the other resistances in the circuit, those of the battery included, and the length and diameter of the wire must be so arranged as to satisfy these conditions.

(v.) The magnetism in solid and in hollow cylinders of the same diameters is the same, provided in the latter case there is sufficient iron for the development of the magnetism.

(vi.) The attraction of an armature by an electromagnet is proportional to the square of the intensity of the current so long as the magnetic moment does not attain its maximum. Two unequally strong electromagnets attract each other with a force proportional to the square of the sum of both currents.

(vii.) For powerful currents the length of the branches of an electromagnet is without influence on the weight which it can support.

As regards the quality of the iron used for the electromagnet, it must be pure, and be made as soft as possible by being reheated and cooled a great many times; it is polished by means of a file so as to avoid twisting. If this is not the case the bar retains, even after the passage of the current, a quantity of magnetism which is called the *remanent magnetism*. A bundle of soft iron wires loses its magnetism more rapidly than a massive bar of the same size. According to Stone, iron wires may be materially improved

for electromagnetic experiments, by forming them into bundles by tying them round with wire; these bundles are then dipped in paraffine and set fire to.

During magnetisation the volume of a magnet does not vary. This has been established by placing the bar to be magnetised with its helix, in a sort of water thermometer, consisting of a flask provided with a capillary tube. On magnetising, no alteration in the position of the water is observed. But the dimensions vary; the diameter is somewhat lessened, and the length increased; according to Joule to the extent of about  $\frac{1}{2700}$ , if the bar is magnetised to saturation.

We shall presently see the numerous applications which have been made of electromagnets in electric telegraphs, in electromagnetic motors, in electric clocks, and in the study of diamagnetic phenomena.

856. **Vibratory motion and sounds produced by currents.**—When a rod of soft iron is magnetised by a strong electric current, it gives a very distinct sound, which, however, is only produced at the moment of closing or opening the current. This phenomenon, which was first observed by Page in America, and by Delezenne in France, has been particularly investigated by De la Rive, who has attributed it to a vibratory motion of the molecules of iron in consequence of a rapid succession of magnetisations and demagnetisations.

When the current is broken and closed at very short intervals, De la Rive has observed that, whatever be the shape or magnitude of the iron bars, two sounds may always be distinguished: one, which is musical, corresponds to that which the rod would give by vibrating transversely; the other, which consists of a series of harsh sounds, corresponding to the interruptions of the current, is compared by De la Rive to the noise of rain falling on a metal roof. The most marked sound, says he, is that obtained by stretching on a sounding-board pieces of soft iron wire, well annealed, from 1 to 2 mm. in diameter, and 1 to 2 yards long. These wires being placed in the axis of one or more bobbins traversed by powerful currents, send forth a number of sounds, which produce a surprising effect, and much resemble that of a number of church bells heard at a distance.

Wertheim has obtained the same sounds by passing a discontinuous current, not through the bobbins surrounding the iron wires, but through the wires themselves. The musical sound is then stronger and more sonorous in general than in the previous experiment. The hypothesis of a molecular movement in the iron wires at the moment of their magnetisation, and of their demagnetisation, is confirmed by the researches of Wertheim, who has found that their elasticity is then diminished.

Reis's *Telephone* consists essentially of a membrane which is put in vibration by producing musical sounds in front of a convenient mouth-piece. The apparatus is so arranged that these vibrations alternately open and close a current which produces, at any distance, sounds by such an arrangement as the above.

#### ELECTRIC TELEGRAPH.

857. **Electric telegraphs.**—These are apparatus by which signals can be transmitted to considerable distances by means of voltaic currents propa-



gated in metallic wires. Towards the end of the last century, and at the beginning of the present, many philosophers proposed to correspond at a distance by means of the effects produced by electrical machines when propagated in insulated conducting wires. In 1811, Sœmmering invented a telegraph, in which he used the decomposition of water for giving signals. In 1820, at a time when the electromagnet was unknown, Ampère proposed to correspond by means of magnetic needles, above which a current was sent, as many wires and needles being used as letters were required. In 1834, Gauss and Weber constructed an electromagnetic telegraph, in which a voltaic current transmitted by a wire acted on a magnetised bar, the oscillations of which under its influence were observed by a telescope. They succeeded in thus sending signals from the Observatory to the Physical Cabinet in Göttingen, a distance of a mile and a quarter, and to them belongs the honour of having first demonstrated experimentally the possibility of electrical communication at a considerable distance. In 1837, Steinheil in Munich, and Wheatstone in London, constructed telegraphs in which several wires each acted on a single needle; the current in the first case being produced by an electromagnetic machine, and in the second by a constant battery.

Every electric telegraph consists essentially of three parts: 1, a *circuit* consisting of a metallic connection between two places, and an *electromotor* for producing the current; 2, a *communicator* for sending the signals from the one station; and, 3, an *indicator* for receiving them at the other station. The manner in which these objects, more especially the last two, are effected can be greatly varied, and we shall limit ourselves to a description of the three principal methods.

One form of electromotor still frequently used in England is a modification of Wollaston's battery. It consists of a trough divided into compartments in each of which is an amalgamated zinc plate and a copper plate; these plates are usually about  $4\frac{1}{2}$  inches in height by  $3\frac{1}{2}$  in breadth. The compartments are filled with sand, which is moistened with dilute sulphuric acid. This battery is inexpensive and easily worked, only requiring from time to time the addition of a little acid; but it has very low electromotive force and considerable resistance, and when it has been at work for some time, the effects of polarisation begin to be perceived. On the telegraphs of the

South Eastern Railways, the platinised graphite (788) battery, invented by Mr. C. V. Walker, is used with success. On circuits on which there is constant work some form of Daniell's battery is used, and for other circuits Leclanche's cell is coming into more extended use. In France, Daniell's battery is used for telegraphic purposes.

The connection between two stations is made by means of galvanised iron wire suspended by porcelain supports (fig. 710), which insulate and

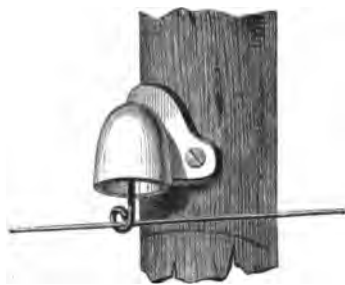

Fig. 710.

protect them against the rain, either on posts or against the sides of buildings. In towns, wires covered with gutta-percha are placed in tubes laid in

the ground. Submarine cables, where great strength is required combined with lightness and high conducting power, are formed on the general type of one of the Atlantic cables, a longitudinal view of which is given in fig. 711,



Fig. 711.

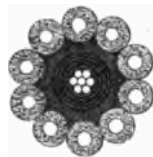

Fig. 712.

while fig. 712 represents a cross section. In the centre is the *core*, which is the conductor ; it consists of seven copper wires, each *mm* in diameter, twisted in a spiral strand and covered with several layers of gutta-percha, between each of which is a coating of *Chatterton's compound*—a mixture of tar, resin, and gutta-percha. This forms the *insulator* proper, and it should have great resistance to the passage of electricity, combined with low specific inductive capacity (725). Round the insulator is a coating of hemp, and on the outside is wound spirally a protecting *sheath* of steel wire, each of which is spun round with hemp.

At the station which sends the despatch, the line is connected with the positive pole of a battery, the current passes by the line to the other station, and if there were a second return line, it would traverse it in the opposite direction to return to the negative pole. In 1837, Steinheil made the very important discovery that the earth might be used for the return conductor, thereby saving the expense of the second line. For this purpose the end of the conductor at the one station, and the negative pole of the battery at the other, are connected with large copper plates, which are sunk to some depth in the ground. The action is then the same as if the earth acted as a return wire. The earth is, indeed, far superior to a return wire ; for the added resistance of such a wire would be considerable, whereas the resistance of the earth beyond a short distance is absolutely *nil*. The earth really *dissipates* the electricity, and does not actually return the same current to the battery.

**858. Wheatstone's and Cooke's single needle telegraph.**—This consists essentially of a vertical multiplier (797) with an astatic needle, the arrangement of which is seen in fig. 714, while fig. 713 gives a front view of the case in which the apparatus is placed. A (fig. 714) is the bobbin, consisting of about 400 feet of fine copper wire, wound in a frame in two connected coils. Instead of an astatic needle, Mr. Walker has found it advantageous to use a single needle formed of several pieces of very thin steel strongly magnetised ; it works within the bobbin, and a light index joined to it by a horizontal axis indicates the motion of the needle on the dial.

The signs are made by transmitting the current in different directions through the multiplier, by which the needle is deflected either to the right or left, according to the will of the operator. The instrument by which this is

effected is a *commutator* or *key*,  $rG$ ; its construction is shown in fig. 714, while fig. 715 shows on a large scale how two stations are connected. It consists of a cylinder of boxwood with a handle, which projects in front of the

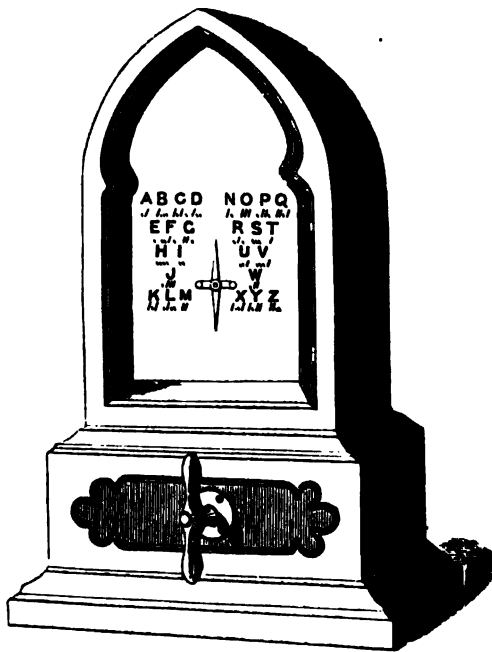

Fig. 713.

case (fig. 713). On its circumference parallel to the axis are seven brass strips (fig. 715), the spaces between which are insulated by ivory; these strips are connected at the end by metallic wires, also insulated from each other, in the following manner:  $a$  with  $b$  and  $c, f$  with  $d$ , and  $e$  with  $g$ . Four springs press against the cylinder;  $x$  and  $y$  are connected with the poles of the battery,  $m$  with the earth plate, and  $n$  with one end of the multiplier,  $N$ .

When not at work the cylinder and the handle are in a vertical position, as seen on the left of the diagram. The circuit is thus *open*, for the pole springs,  $x$  and  $y$ , are not connected with the metal of the commutator. But if, as in the figure on the right, the key is turned to the right, the battery is brought into the circuit, and the current passes in the following direction: + pole  $x'a'b'n'M'q'N$ , conductor  $qpMnacmEp$ , earth  $p'E'm'e'g'y'$ , - pole. The coils  $N$  and  $N'$  are so arranged that by the current the motion of the needle corresponds to the motion of the handle. By turning the handle to the left the current would have the following direction: + pole  $x'd'f'm'E'p'$ , earth  $p'EmcabnMq$ , conductor  $p'q'M'n'b'a'y'$ , - pole, and thus the needle would be deflected in the opposite direction.

The signs are given by differently combined deflections of the needle, as represented in the alphabet on the dial (fig. 713). \ denotes a deflection of the upper end of the needle to the left, and / a deflection to the right ; l

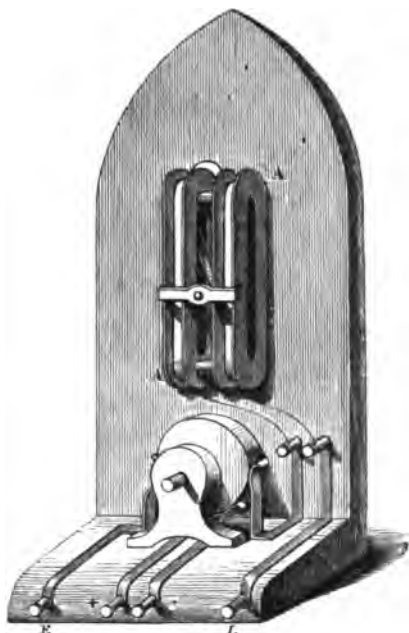

Fig. 714.

for instance, is indicated by two deflections to the left, and M by two to the right. Some of the marks on the alphabet are only half as long as the others ; this indicates that the shortest of the connected marks must first be signalled. Thus, D is expressed by right-left-left, and C by right-left-right-left, etc.

These signs are somewhat complicated and require great practice ; usually not more than 12 to 20 words can be sent in a minute. The single needle telegraph was formerly sometimes replaced by the double needle one, which is constructed on the same principle, but there are two needles and two wires instead of one.

859. **Dial telegraphs.**—Of these many kinds exist. Figs. 717 and 718 represent a lecture-model of one form, constructed by M. Froment, and which well serves to illustrate the principle. It consists of two parts : the *manipulator* for transmitting signals (fig. 717), and the *indicator* (fig. 718) for receiving them. The first apparatus is connected with a battery, Q, and the two apparatus are in communication by means of metallic wires, one of which, AOD (fig. 717), goes from the departure to the arrival station, and the other, HKLI (fig. 718), from the arrival to the departure. In practice, the latter is replaced by the earth circuit. Each apparatus is furnished with

a dial with 25 of the letters of the alphabet, on which a needle moves. The needle at the departure station is moved by hand, that of the arrival by electricity.

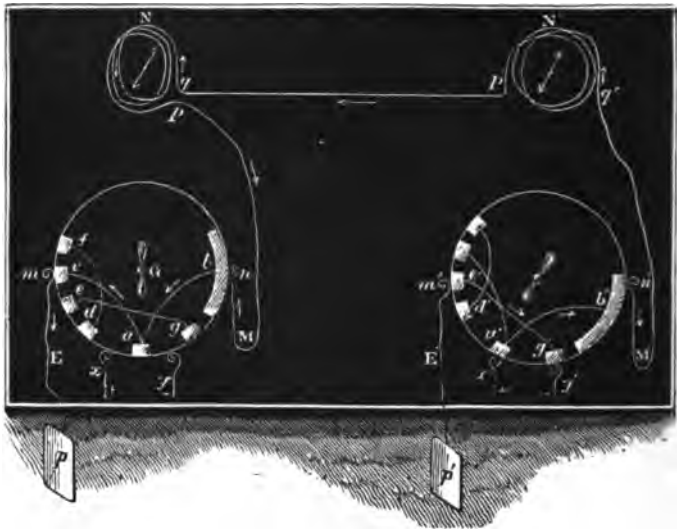

Fig. 715.

The path of the current and its effects are as follows : from the battery it passes through a copper wire, A (fig. 717), into a brass spring, N, which presses against a metal wheel, R, then by a second spring, M, into the wire O, which joins the other station. Thence the current passes into the bobbin of an electromagnet, *b*, not fully shown in fig. 718, but of which fig. 716

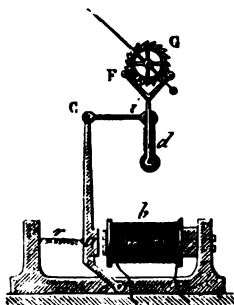

Fig. 716.

represents a section, showing the front of the apparatus. This electromagnet is fixed horizontally at one end, and at the other it attracts an armature of soft iron, *a*, which forms part of a bent lever, movable about its axis, *o*, while a spring, *r*, attracts the lever in the opposite direction.

When the current passes, the electromagnet attracts the lever *aC*, which by a rod, *i*, acts on a second lever, *d*, fixed to a horizontal axis, itself connected with a fork, F. When the current is broken the spring *r* draws the lever *aC*, and therewith all the connected pieces; a backward and forward motion is produced, which is communicated to the fork F, which transmits it to a toothed wheel, C, on the axis of which is the needle. From the arrangement of its teeth, the wheel G is always moved in the same direction by the fork.

To explain the intermittent action of the magnet, we must refer to fig. 717. The toothed wheel, R, has 26 teeth, of which 25 correspond to letters

of the alphabet, and the last to the interval reserved between the letters A and Z. When holding the knob P in the hand the wheel R is turned, the end

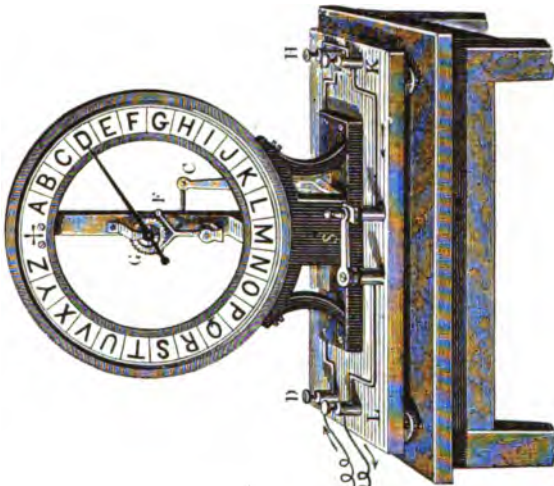

Fig. 718.

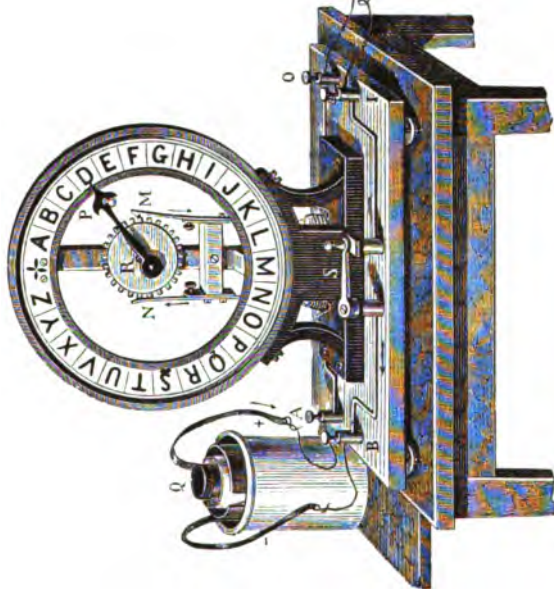

Fig. 717.

of the plate N from its curvature is always in contact with the teeth ; the plate M, on the contrary, terminates in a catch cut so that contact is alter-

nately made and broken. Hence, the connections with the battery having been made, if the needle P is advanced through four letters, for example, the current passes four times in N and M, and is four times broken. The electromagnet of the arrival station will then have attracted four times, and have ceased to do so four times. Lastly, the wheel G will have turned by four teeth, and as each tooth corresponds to a letter, the needle of the arrival station will have passed through exactly the same number of letters as that of the departure station. The piece S, represented in the two figures, is a copper plate, movable on a hinge, which serves to make or to break the current at will.

From this explanation it will be readily intelligible how communications are made between different places. Suppose, for example, that the first apparatus being at London and the second at Brighton, there being metallic connection between the two towns, it is desired to send the word *signal* to the latter town: as the needles correspond on each apparatus to the interval retained between A and Z, the person sending the despatch moves the needle P to the letter S, where it stops for a very short time; as the needle at Brighton accurately reproduces the motion of the London needle, it stops at the same letter, and the person who receives the despatch notes this letter. The one at London, always continuing to turn in the same direction, stops at the letter I, the second needle immediately stops at the same letter; and continuing in the same manner with the letters G, N, A, L, all the word is soon transmitted to Brighton. The attention of the observer at the arrival station is attracted by means of an electric alarm. Each station further, must be provided with the two apparatus, figs. 717 and 718, without which it would be impossible to answer.

860. **Morse's telegraph.**—The telegraphs hitherto described leave no trace of the despatches sent, and if any errors have been made in copying the signals there is no means of remedying them. These inconveniences are not met with in the case of the *writing telegraphs*, in which the signs themselves are printed on a strip of paper at the time at which they are transmitted.

Of the numerous printing and writing telegraphs which have been devised, that of Morse, first brought into use in North America, is best known. It has been almost universally adopted on the Continent. In this instrument there are three distinct parts: the *indicator*, the *communicator*, and the *relay*; figs. 719, 720, and 721 represent these apparatus.

*Indicator.* We will first describe the indicator (fig. 719), leaving out of sight for the moment the accessory pieces, G and T, placed on the right of the figure. The current which enters the indicator by the wire, C, passes into an electromagnet E, which, when the current is closed, attracts an armature of soft iron, A, fixed at the end of a horizontal lever movable about an axis,  $x$ ; when the current is open the lever is raised by a spring,  $r$ . By means of two screws,  $m$  and  $v$ , the amplitude of the oscillations is regulated. At the other end of the lever there is a pencil,  $o$ , which writes the signals. For this purpose a long band of strong paper,  $pp$ , rolled round a drum, R, passes between two copper rollers with a rough surface,  $u$ , and turning in contrary directions. Drawn in the direction of the arrows, the band of paper becomes rolled on a second drum, Q, which is turned by hand. A clockwork

motion placed in the box, BD, works the rollers, between which the band of paper passes.

The paper being thus set in motion, whenever the electromagnet works, the point *o* strikes the paper, and, without perforating it, produces an inden-

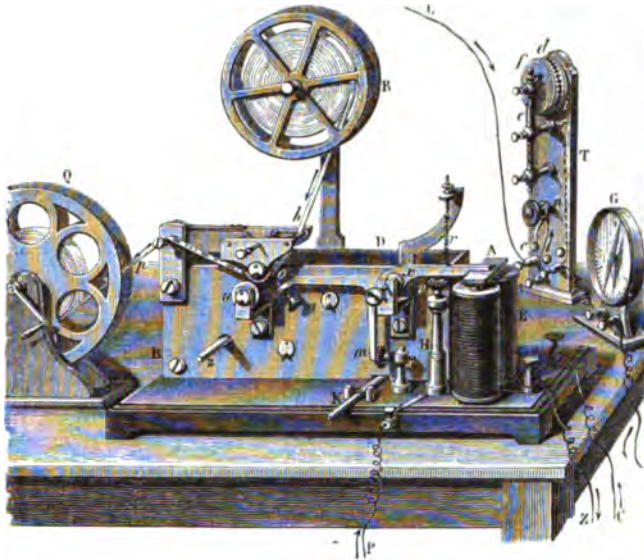

Fig. 719.

tation, the shape of which depends on the time during which the point is in contact with the paper. If it only strikes it instantaneously, it makes a *dot* (-) or short stroke ; but if the contact has any duration a *dash* (—) of corresponding length is produced. Hence, by varying the length of contact of the transmitting key at one station, a combination of dots and dashes may be produced at another station, and it is only necessary to give a definite meaning to these combinations.

The same telegraphic alphabet is now universally used wherever telegraphic communication exists ; and the signals for the single needle instrument (fig. 719), as well as those used for printing have been modified, so that they now correspond to each other. Thus a beat of the top of the needle to the left \ is equivalent to a dot ; and a beat to the right / to a dash. The figure on the following page gives the alphabet.

*Communicator or key.* This consists of a small mahogany base, which acts as support for a metallic lever *ab* (fig. 720), movable in its middle on a horizontal axis. The extremity *a* of this lever is always pressed upwards by a spring beneath, so that it is only by pressing with the finger on the key *B* that the lever sinks and strikes the button *x*. Round the base there are three binding screws ; one connected with the wire *P*, which comes from the positive pole of the battery ; the second connected with *L*, the wire of the



line ; and the third with the wire A, which passes to the indicator, for of course two places in communication are each provided with an indicator and communicator.

PRINTING.	SINGLE NEEDLE.	PRINTING.	SINGLE NEEDLE.
A ---	✓	N ---	/\
B -----	/\	O -----	///
C -----	/\	P -----	✓\
D ---	/\	Q -----	///
E -	\	R -----	✓\
F -----	✓\	S ---	✓
G -----	///	T ---	/
H -----	✓	U -----	✓\
I --	"	V -----	✓✓\
J -----	✓///	W -----	///
K -----	/\	X -----	/\✓
L -----	✓\	Y -----	/\//
M ---	//	Z -----	///\

These details known, there are two cases to be considered. 1. The communicator is arranged so as to receive a despatch from a distant post ; the extremity *b* is then depressed, as represented in the drawing, so that the



Fig. 720.

current which arrives by the wire of the line L, and ascends in the metallic piece *m*, redescends in the wire A, which leads it to the indicator of the post at which the apparatus is placed. 2. A despatch is to be transmitted ; in this case the key B is pressed so that the lever comes in contact with the button *x*. The current of the local battery, which comes by the wire P, ascending then in the lever, redescends by *m* and joins the wire L, which conducts it to the post to which the despatch is addressed. According to the

length of time during which B is pressed, a dot or a line is produced in the receiver to which the current proceeds.

*Relay.* In describing the receiver we have assumed that the current of the line coming by the wire C (fig. 719) entered directly into the electromagnet, and worked the armature A, producing a despatch; but when the current has traversed a distance of a few miles its intensity has diminished so greatly that it cannot act upon the electromagnet with sufficient force to print a despatch. Hence it is necessary to have recourse to a relay—that is, to an auxiliary electromagnet which is still traversed by the current of the line, but which serves to introduce into the communicator the current of a local battery of 4 or 5 elements placed at the station, and which is only used to print the signals transmitted by the wire.

For this purpose the current entering the relay by the binding screw, L (fig. 721), passes into an electromagnet, E, whence it passes into the earth

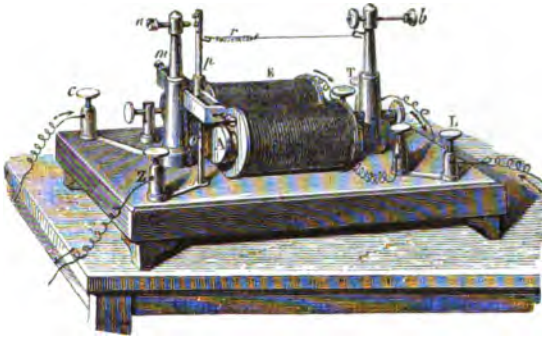

Fig. 721.

by the binding screw T. Now, each time that the current of the line passes into the relay, the electromagnet attracts an armature, A, fixed at the bottom of a vertical lever  $p$ , which oscillates about a horizontal axis.

At each oscillation the top of the lever  $p$  strikes against a button,  $n$ , and at this moment the current of the local battery which enters by the binding screw,  $c$ , ascends the column  $m$ , passes into the lever  $p$ , descends by the rod  $o$ , which transmits it to the screw  $Z$ : thence it enters the electromagnet of the indicator, whence it emerges by the wire  $Z$ , to return to the local battery from which it started. Then when the current of the line is open, the electromagnet of the relay does not act, and the level  $p$ , drawn by a spring  $r$ , leaves the button  $n$ , as shown in the drawing, and the local current no longer passes. Thus the relay transmits to the indicator exactly the same phases of passage and intermittence as those effected by the manipulator in the post which sends the despatch.

With a general battery of 25 Daniell's elements the current is strong enough at upwards of 90 miles from its starting-point to work a relay. For a longer distance a new current must be taken, as will be seen in the paragraph on the change of current (*vide infra*).

*Working of the three apparatus.* The three principal pieces of Morse's apparatus being thus known, the following is the actual path of the current.

The current of the line coming by the wire L (fig. 721) passes at first to the piece T intended to serve as lightning conductor, when, from the influence of atmospheric electricity in time of storm, the conducting wires become charged with so much electricity as to give dangerous sparks. This apparatus consists of two copper discs, *d* and *f*, provided with teeth on the sides opposite each other, but not touching. The disc *d* is connected with the earth by a metal plate at the back of the stand which supports this lightning conductor, while the disc *f* is in the current. The latter coming by the line L enters the lightning conductor by the binding screw fixed at the lower part of the stand on the left; then rises to a commutator, *u*, which conducts it to a button, *c*, whence it reaches the disc *f* by a metal plate at the back of the stand; in case a lightning discharge should pass along the wire, it would now act inductively on the disc *d*, and emerge by the points without danger to those about the apparatus. Moreover, from the disc *f*, the current passes into a very fine iron wire insulated on a tube *e*. As the wire is melted when the discharge is too intense, the electricity does not pass into the apparatus, which still further removes any danger.

Lastly, the current proceeds from the foot of the support *s* to a screw on the right, which conducts it to a small galvanometer, G, serving to indicate by the deflection of the needle whether the current passes. From this galvanometer the current proceeds to a commutator (fig. 720), which it enters at L, whence it emerges at A to go to the relay (fig. 721). Entering this at L, it works the electromagnet, and establishes the communication necessary for the passage of the current of the local battery, as has been said in speaking of the relay.

*Change of current.* To complete this description of Morse's apparatus it must be observed that in general the current which arrives at L, after having traversed several miles, has not sufficient force to register the despatch, nor to proceed to a new distant point. Hence, in each telegraphic station a new current must be taken, that of the *postal battery*, which consists of 20 to 30 Daniell's elements, and is not identical with the *local battery*.

This new current enters at P (fig. 719), reaches a binding screw which conducts it to the column H, and thence only proceeds further when the armature A sinks. A small contact placed under the lever touches then the button *v*; the current proceeds from the column H to the metallic mass BD, whence by a binding screw and a wire, not represented in the figure, it reaches lastly the wire of the line, which sends it to the following post, and so on from one point to another.

861. **Induction in telegraph cables.**—In the earliest experiments on the use of insulated subterranean wires for telegraphic communication it was found that difficulties occurred in their use which were not experienced with overland wires. This did not arise from defective insulation, for the better the insulation the greater the difficulty. It was suspected by Siemens and others that the retardation was due to statical induction taking place between the inner wire through the insulator and the external moisture; and that this was the case Faraday proved by the following experiments among others. A length of about 100 miles of gutta-percha-covered copper wire was im-

mersed in water, the ends being led into the chamber of observation. When the pole of a battery containing a large number of cells was momentarily connected with one end of the wire, the other end being insulated, and a person simultaneously touched the wire and the earth contact, he obtained a violent shock.

When the wire, after being in momentary contact with the battery, was placed in connection with a galvanometer, a considerable deflection was observed; there was a feebler one 3 or 4 minutes after, and even as long as 20 or 30 minutes afterwards.

When the insulated galvanometer was permanently connected with one end of the wire, and then the free end of the galvanometer wire joined to the pole of the battery, a rush of electricity through the galvanometer into the wire was perceived. This speedily diminished and the needle ultimately came to rest. When the galvanometer was detached from the battery and put to earth, the electricity flowed as rapidly out of the wire, and the needle was momentarily deflected in the opposite direction.

These phenomena are not difficult to explain. The wire with its thin insulating coating of gutta-percha becomes statically charged with electricity from the battery. The coating of gutta-percha through which the inductive action takes place is only  $\frac{1}{12}$  of an inch in thickness, and the extent of the coatings is very great. The surface of the copper wire amounts to 8,300 square feet, and that of the outside coating is four times as much. The potential can only be as great as that of the battery, but from the enormous surface the quantity is very great. Thus the wires, after being detached from the battery, showed all the actions of a powerful electric battery. These effects cannot take place with wires in air, for the external coating is wanting, or at all events is so distant that induction and charge cannot occur.

Hence the difficulty in submarine telegraphy. The electricity which enters the insulating wire must first be used in charging the large Leyden jar which it constitutes, and only after this has happened can the current reach the distant end of the circuit. The current begins later at the distant end, and ceases sooner. If the electrical currents follow too rapidly, an uninterrupted current will appear at the other end, which indicates small differences in strength, but not with sufficient clearness, differences in duration or direction. Hence in submarine wires the signals must be slower than in air wires to obtain clear indications. By the use of alternating currents—that is, of currents which are alternately positive and negative—their disturbing influences may be materially lessened, and communication be accelerated and made more certain, but they can never be entirely obviated.

In the Atlantic Cable, instruments on the principle of Thomson's reflecting galvanometer (798), are used for the reception of signals; the motions of the spot of light to the right and left forming the basis of the alphabet.

**862. Duplex telegraphy.**—By this is meant a system of telegraphy by which messages may be simultaneously sent in opposite directions on one and the same wire, whereby the working capacity of a line is practically doubled.

Several plans have been devised for accomplishing this very important

improvement; no more can here be attempted than to give a general account of the principle of the method in one case.

Let *m*, fig. 722, represent the electromagnet of a Morse's instrument which is wound round with two equal coils in opposite directions; these coils

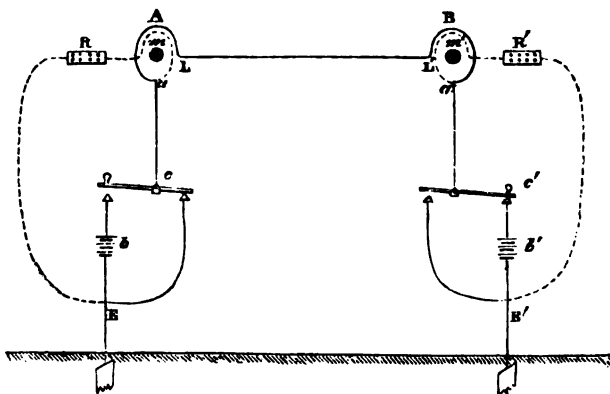

Fig. 722.

are represented by the full and dotted lines, and one of them, which may be called the *line coil*, is joined to the line *LL'*, which connects the two stations. The other coil, that represented by the dotted line, which may be called the *equating coil*, is in connection with the earth at *E* by means of an adjustable resistance, or *artificial line R*. By this means the resistance of the branch *a RE* may be made equal to that of the branch *a LL' a'*. The battery *b* has one pole to earth at *E*, and the other pole, by means of a make-and-break key *c*, can be connected at *a*, where the two oppositely wound coils bifurcate. The back contact of the key is also connected with earth.

The station at *B* is arranged in a similar manner, as is represented by corresponding letters with affixes.

Now when *B* depresses his key and sends a current into the line, inasmuch as the electromagnet of his instrument is wound with equal coils in opposite directions, the armature is not attracted, for the core is not magnetised, because the currents in the two coils counteract one another. Thus, although a current passes from *B*, there is no indication of it in his own instrument—a condition essential in all systems of duplex telegraphy.

But with regard to the effect on *A*, there are two cases according as he is or is not sending a message at the same time. If *A*'s key is not down, then the current will circulate round the core of the electromagnet and will reach the earth by the path *L a c E*; the core will therefore become magnetised, the armature attracted, and a signal be produced in the ordinary way.

If, however, at the moment at which *B* has his key down, *A* also depresses his, then it will be seen that, as currents are sent in opposite directions from both *A* and *B*, they neutralise one another, no current passes in the line *a LL' a'*; it is, as it were, blocked. But though no current passes in the line

coil, a current does pass at each station to earth, through the equating coil, which being no longer counterbalanced by any opposite current in the line coil, magnetises the core of the electromagnet, which thus attracts the armature and produces a signal.

We have here supposed that A and B both send for instance the same currents to line; the final effect is not different if they send opposite currents at the same time. For then, as they neutralise each other in the line LL', the effect is the same as if the resistance of the line were diminished. More electricity flows at line from each station through the line coil being no longer balanced by the equating coil; the current of the line coil preponderates and works the electromagnet.

Hence in both these cases, each station, so to speak, produces the signal which the other one wishes to send.

863. **Bain's electro-chemical telegraph.**—If a strip of paper be soaked in an aqueous solution of ferrocyanide of potassium and connected with the negative pole of a battery, and if the other face be touched with a steel pointer connected with the positive pole, a blue mark due to the formation of some Prussian blue will be formed about the iron, so long as the current passes. The first telegraph based on this principle was invented by Bain. The alphabet is the same as Morse's, but the despatch is first composed at the departure station on a long strip of ordinary paper. It is perforated successively by small round and elongated holes, which correspond respectively to the dots and marks. This strip of paper is interposed between a small metal wheel and a metal spring, both forming part of the circuit. The wheel in turning, carries with it the paper strip, all parts of which pass successively between the wheel and the plate. If the strip were not perforated, it would, not being a conductor, constantly offer a resistance to the passage of the current; but, in consequence of the holes, every time one of them passes there is contact between the wheel and the plate. Thus the current works the relay of the post to which it is sent, and traces in blue, on a paper disc, impregnated with ferrocyanide of potassium, the same series of points and marks as those on the perforated paper.

864. **The Sounder.**—The sound produced when the armature of the electromagnet in a Morse's instrument is attracted by the passage of the current is so distinct and clear that many telegraph operators have been in the habit of reading the messages by the sounds thus produced, and at most of checking their reading by comparison with the signs produced on the paper.

Based on this fact a form of instrument invented in America has come into use for the purpose of reading by sound. The *sounder*, as it is called, is essentially a small electromagnet on an ebonite base, resembling the relay in fig. 835. The armature is attached to one end of a lever, and is kept at a certain distance from the electromagnet by a spring. When the current passes, the armature is attracted against the electromagnet, with a sharp click, and when the current ceases it is withdrawn by the spring. Hence the interval between the sounds is of longer or shorter duration according to the will of the sounder, and thus in effect a series of short and long sounds can be produced which correspond to the dots and dashes of the Morse alphabet.

Such instruments are simple, easily adjusted, and portable, not occupying more space than an ordinary fieldglass. They are coming into extended use, especially for military telegraph work.

865. **Electric alarm.**—One form of these instruments is represented in fig. 723. On a wooden board arranged vertically is fixed an electromagnet

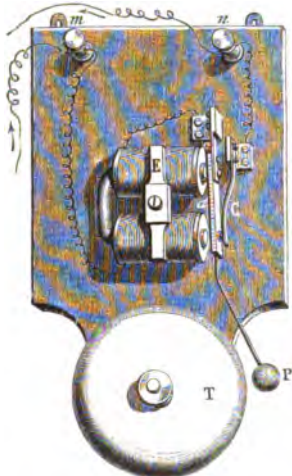

Fig. 723.

E; the line wire is connected with the binding screw *m*, with which is also connected one end of the wire of the electromagnet; the other end is connected with a spring *c*, to which is attached the armature *a*; this again is pressed against by a spring *C*, which in turn is connected with the binding screw *n* from which the wire leads to earth.

Whenever the current passes, the armature *a* is attracted, carrying with it a hammer *P*, which strikes against the bell *T* and makes it sound. The moment this takes place, contact is broken between the armature *a* and the spring *C*, and the current being stopped the electromagnet does not act; the spring *c*, however, in virtue of its elasticity, brings the armature in contact with the spring *C*, the current again passes, and so on as long as the current continues to pass.

866. **Electrical clocks.**—Electrical clocks are clockwork machines, in which an electromagnet is both the motor and the regulator, by means of an electric current regularly interrupted, in a manner resembling that described in the

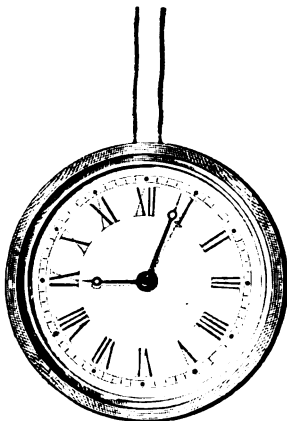

Fig. 724.

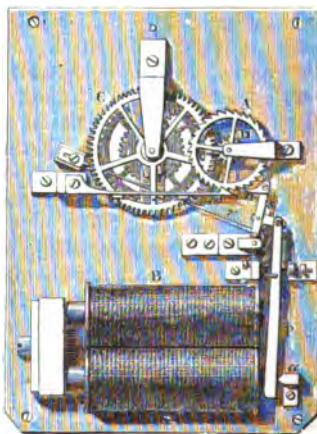

Fig. 725.

preceding paragraph. Fig. 724 represents the face of such a clock, and fig. 725 the mechanism which works the needles.

An electromagnet, B, attracts an armature of soft iron, P, movable on a pivot, *a*. The armature P transmits its oscillating motion to a lever, *s*, which, by means of a ratchet *n*, turns the wheel A. This, by the pinion D, turns the wheel C, which by a series of wheels and pinions moves the hands. The small one marks the hours, the large one the minutes; but as the latter does not move regularly, but by sudden starts from second to second, it follows that it may also be used to indicate the seconds.

It is obvious that the regularity of the motion of the hands depends on the regularity of the oscillations of the piece P. For this purpose, the oscillations of the current, before passing into the electromagnet B, are regulated by a standard clock, which itself has been previously regulated by a seconds pendulum. At each oscillation of the pendulum there is an arrangement by which it opens and closes the current, and thus the armature P beats seconds exactly.

To illustrate the use of these electrical clocks, suppose that on the railway from London to Birmingham each station has an electric clock, and that from the London station a conducting wire passes to all the clocks on the line as far as Birmingham. When the current passes in this wire all the clocks will simultaneously indicate the same hour, the same minute, and the same second; for electricity travels with such enormous velocity, that it takes an inappreciable time to go from London to Birmingham.

867. **Electromagnetic machines.**—Numerous attempts have been made to apply electromagnetism as a motive power in machines. Fig. 726 represents a machine of this kind constructed by M. Froment. It consists of four powerful electromagnets, ABCD, fixed on an iron frame, X. Between these electromagnets is a system of two iron wheels movable on the same horizontal axis, with eight soft iron armatures, M, on their circumference.

The current arrives at K, ascends in the wire E, and reaches a metallic arc, O, which serves to pass the current successively into each electromagnet, so that the attractions exerted on the armatures M shall always be in the same direction. Now this can only be the case provided the current is broken in each electromagnet just when an armature comes in front of the axis of the bobbin. To produce this interruption the arc O has three branches *e*, each terminating with a steel spring, to which a small sheave is attached. Two of these establish the communication respectively with an electromagnet, and the third with two. On a central wheel, *a*, there are cogs, on which the sheaves alternately rest. Whenever one of them rests on a cog, the current passes into the corresponding electromagnet, but ceases to pass when there is no longer contact. On emerging from the electromagnets the current passes to the negative pole of the battery by the wire H.

In this manner, the armatures M being successively attracted by the four electromagnets, the system of wheels which carries them assumes a rapid rotatory motion, which by the wheel P and an endless band is transmitted to a sheave, Q, which sends it finally to any machine, a grinding mill for example.

In his workshops M. Froment has an electromotive engine of one-horse power. But as yet these machines have not been applied in manufactures, for the expense of the acids and the zinc which they use very far exceeds that of the coal in steam-engines of the same force. Until some cheaper



source of electricity shall have been discovered there is no expectation that they can be applied at all advantageously.

Thus a machine devised by Kravogl produces about 17 per cent. of the useful effect due to the zinc, and therefore in utilising this force they are

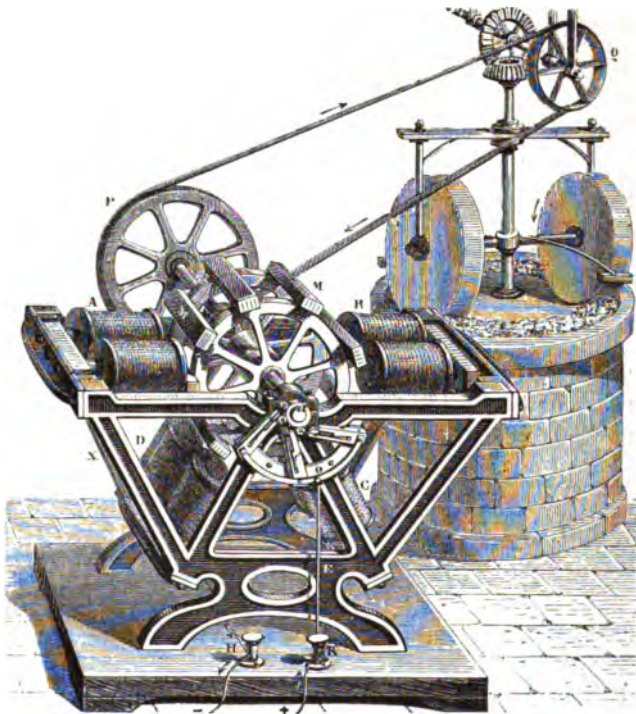

Fig. 726.

about equal to the best steam-engines. But a pound of coal yields 7,200 thermal units, and a pound of zinc only 1,200 (470); and as zinc is ten times as dear as coal, engines worked by electricity, independently of any question as to the cost of construction, are sixty times as dear to work as steam-engines.

The energy of the electrical current may be compared with the *vis viva* of a small mass, which moves with very great velocity. Hence it can be understood that the most advantageous employment of electricity is to be found not so much in the transformation of its *vis viva* into the relatively slow movement of large masses, as in the rapid transmission of a small power to great distances, as in the electric telegraph.

## CHAPTER VI.

## VOLTAIC INDUCTION.

868. **Induction by currents.**—We have already seen (721) that under the name *induction* is meant the action which electrified bodies exert at a distance on bodies in the natural state. Hitherto we have only had to deal with electrostatical induction; we shall now see that dynamical electricity produces analogous effects.

Faraday discovered this class of phenomena in 1832, and he gave the name of *currents of induction* or *induced currents* to instantaneous currents developed in metallic conductors under the influence of metallic conductors traversed by electric currents, or by the influence of powerful magnets, or even by the magnetic action of the earth; and the currents which give rise to them he called *inducing currents*.

The inductive action of a current at the moment of opening or closing may be shown by means of a bobbin with two wires. This consists (fig. 727)

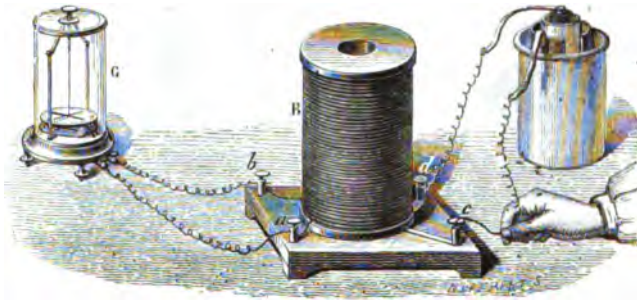

Fig. 727.

of a cylinder of wood or of cardboard, on which a quantity of silk-covered No. 16 copper wire is coiled; on this is coiled a considerably greater length of fine copper wire, about No. 35, also insulated by being covered with silk. This latter coil, which is called the *secondary coil*, is connected by its ends with two binding screws, *a*, *b*, from which wires pass to a galvanometer, while the thicker wire, the *primary coil*, is connected by its extremities with two binding screws, *c* and *d*. One of these, *d*, being connected with one pole of a battery, when a wire from the other pole is connected with *c*, the current passes in the primary coil, and in this alone. The following phenomena are then observed:—

i. At the moment at which the thick wire is traversed by the current the galvanometer, by the deflection of the needle, indicates the existence in the *secondary coil* of a current *inverse* to that in the primary coil, that is, in the contrary direction; this is only instantaneous, for the needle immediately reverts to zero, and remains so long as the inducing current passes through *cd*.

ii. At the moment at which the current is opened, that is, when the wire *cd* ceases to be traversed by a current, there is again produced in the wire *ab* an induced current instantaneous like the first, but *direct*, that is in the same direction as the inducing current.

869. **Production of induced currents by continuous ones.**—Induced currents are also produced when a primary coil traversed by a current is approached to or removed from a secondary one : this may be shown by the following apparatus, fig. 728, in which B is a hollow coil consisting of a

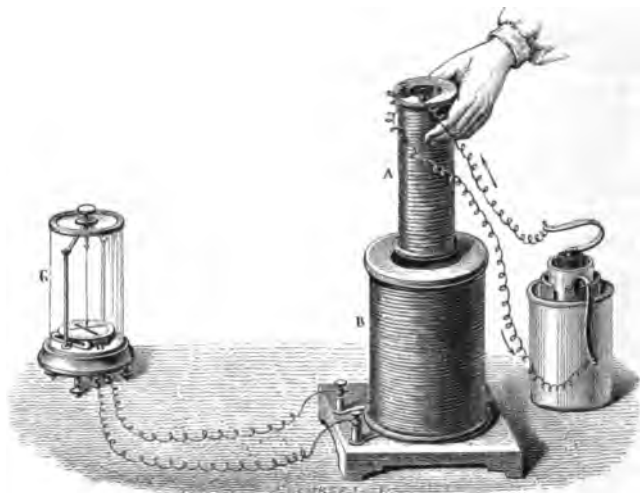

Fig. 728.

great length of fine wire, and A a coil consisting of a shorter and thicker wire, and of such dimensions that it can be placed in the secondary coil. The coil A being traversed by a current, if it is suddenly placed in the coil B, a galvanometer connected with the latter indicates by the direction of its deflection the existence in it of an *inverse* current ; this is only instantaneous, the needle rapidly returns to zero, and remains so as long as the small bobbin is in the large one. If it is rapidly withdrawn, the galvanometer shows that the wire is traversed by a *direct* current. If, instead of rapidly introducing or replacing the primary coil, this is done slowly, the galvanometer only indicates a weak current, and which is the feebler the slower the motion.

If, instead of varying the distance of the inducing current, its intensity be varied, that is, either increased by bringing additional battery power into the circuit, or diminished by increasing the resistance, an induced current is produced in the secondary wire, which is *inverse* if the intensity of the inducing current increases and *direct* if it diminishes.

870. **Conditions of induction. Lenz's law.**—From the experiments which have been described in the previous paragraphs the following principles may be deduced :—

I. The distance remaining the same, a *continuous and constant current does not induce any current in an adjacent conductor.*

II. *A current at the moment of being closed, produces in an adjacent conductor an inverse current.*

III. *A current at the moment it ceases, produces a direct current.*

IV. *A current which is removed, or whose intensity diminishes, gives rise to a direct induced current.*

V. *A current which is approached or whose intensity increases, gives rise to an inverse induced current.*

VI. On the induction produced between a closed circuit and a current in activity, when their relative distance varies, Lenz has based the following law, which is known as *Lenz's Law* :—

*If the relative position of two conductors A and B be changed, of which A is traversed by a current, a current is induced in B in such a direction that by its electrodynamic action on the current in A, it would have imparted to the conductors a motion of the contrary kind to that by which the inducing action was produced.*

Thus, for instance, in V, when a current is approached to a conductor, an inverse current is produced ; but two conductors traversed by currents in opposite directions, *repel* one another according to the received laws of electrodynamics (833). Inversely when a current is *moved away from* a conductor, a current of the same direction is produced ; now two currents in the same direction *attract* one another.

On bringing the inducing wire near the induced as well as in removing it away work is required ; hence a quantity of heat proportional to the work consumed must result, as Edlund's investigations have shown. On the other hand, when induction results from the opening and closing of the circuit (II. and III.) no work is lost, but the inducing current loses as much heat as is produced in the induced circuit.

871. **Inductive action of the Leyden discharge.**—Figure 729 represents an apparatus devised by Matteucci, which is very well adapted for showing

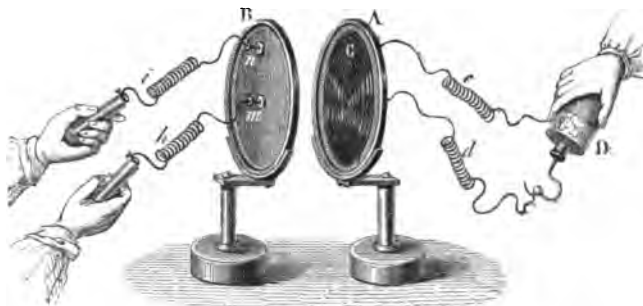

Fig. 729.

the development of induced currents produced either by the discharge of a Leyden jar or by the passage of a voltaic current.

It consists of two glass plates about 12 inches in diameter, fixed vertically

on the two supports A and B. These supports are on movable feet, and can either be approached or removed at will. On the anterior face of the plate A are coiled about 30 yards of copper wire, C, a millimetre in diameter. The two ends of this wire pass through the plate, one in the centre, the other near the edge, terminating in two binding screws, like those represented in *m* and *n*, on the plate B. To these binding screws are attached two copper wires, *c* and *d*, through which the inducing current is passed.

On the face of the plate B, which is towards A, is enrolled a spiral of finer copper wire than the wire C. Its extremities terminate in the binding screws *m* and *n*, on which are fixed two wires, *h* and *i*, intended to transmit the induced current. The two wires on the plates are not only covered with silk, but each circuit is insulated from the next one by a thick layer of shellac varnish.

In order to show the production of the induced current by the discharge of a Leyden jar, one end of the wire C is connected with the outer coating, and the other end with the knob of the Leyden jar, as shown in the figure. When the spark passes, the electricity traversing the wire C acts by induction on the neutral fluid of the wire on the plate B, and produces an instantaneous current in this wire. A person holding two copper handles connecting with the wires *i* and *h* receives a shock, the intensity of which is greater in proportion as the plates A and B are nearer. This experiment proves that frictional electricity can give rise to induced currents as well as voltaic electricity.

The experiment may also be made by simply twisting together two lengths of a foot of gutta-percha-covered copper wire. The ends of one length being held in the hand, an electric discharge is passed through the other length.

The above apparatus can also be used to show the production of induced currents by the influence of voltaic currents. For this purpose the current of a battery is passed through the inducing wire C, while the ends of the other wire, *h* and *i*, are connected with a galvanometer. At the moment at which the current commences or finishes, or when the distance of the two conductors is varied, the same phenomena are observed as in the case of the apparatus represented in fig. 727.

□ 872. **Induction by magnets.**—It has been seen that the influence of a current magnetises a steel bar; in like manner a magnet can produce induced currents in metallic circuits. Faraday has shown this by means of a coil with a single wire of 200 to 300 yards in length. The two extremities of the wire being connected with a galvanometer, as shown in fig. 730, a strongly magnetised bar is suddenly inserted in the bobbin, and the following phenomena are observed :—

- i. At the moment at which the magnet is introduced, the galvanometer indicates in the wire the existence of a current, the direction of which is opposed to that which circulates round the magnet, considering the latter as a solenoid on Ampère's theory (852).
- ii. When the bar is withdrawn, the needle of the galvanometer, which has returned to zero, indicates the existence of a direct current.

The inductive action of magnets may also be illustrated by the following experiment : a bar of soft iron is placed in the above bobbin and a strong

magnet suddenly brought in contact with it; the needle of the galvanometer is deflected, but returns to zero when the magnet is stationary, and is de-

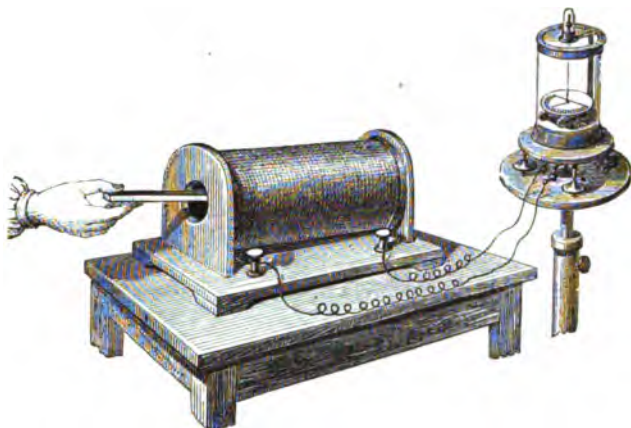

Fig. 730.

flected in the opposite direction when it is removed. The induction is here produced by the magnetisation of the soft iron bar in the interior of the bobbin under the influence of the magnet.

The same inductive effects are produced in the wires of an electromagnet, if a strong magnet be made to rotate rapidly in front of the extremities of the wire in such a manner that its poles act successively by influence on the two branches of the electromagnet: or also by forming two coils round a horse-shoe magnet, and passing a plate of soft iron rapidly in front of the poles of the magnet; the soft iron becoming magnetic reacts by influence on the magnet, and induced currents are produced in the wire alternately in different directions.

The inductive action of magnets is a striking confirmation of Ampère's theory of magnetism. For as on this theory all magnets are solenoids, all the experiments which have been mentioned may be explained by the inductive action of currents which traverse the surface of magnets; the induction of magnets is in short an induction of currents. And it is a useful exercise to see how on this view the inductive action of magnets falls under Lenz's law (870).

873. **Inductive action of magnets on bodies in motion.**—Arago was the first to observe, in 1824, that the number of oscillations which a magnetised needle makes in a given time, under the influence of the earth's magnetism, is very much lessened by the proximity of certain metallic masses, and especially of copper, which may reduce the number in a given time from 300 to 4. This observation led Arago in 1825 to the discovery of an equally unexpected fact; that of the rotative action which a plate of copper in motion exercises on a magnet.

This phenomenon may be shown by means of the apparatus represented

in fig. 731. It consists of a copper disc, M, movable about a vertical axis. On this axis is a sheave, B, round which is coiled an endless cord, passing also round the sheave A. By turning this with the hand, the disc M may be rotated with great rapidity. Above the disc is a glass plate, on which is a small pivot supporting a magnetic needle, *ab*. If the disc be now moved with a slow and uniform velocity, the needle is deflected in the direction of the motion, and stops at an angle of from  $20^\circ$  to  $30^\circ$  with the direction of the

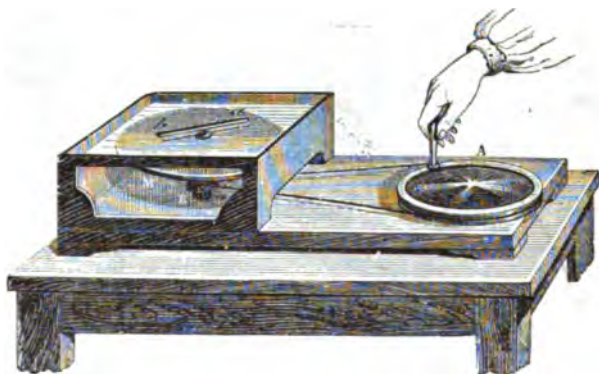

Fig. 731.

magnetic meridian, according to the velocity of the rotation of the disc. But if this velocity increases, the needle is ultimately deflected more than  $90^\circ$ ; it is then carried along, describes an entire revolution, and follows the motion of the disc until this stops.

Babbage and Herschel modified Arago's experiment by causing a horse-shoe magnet placed vertically to rotate below a copper disc suspended on silk threads without torsion; the disc rotated in the same direction as the magnets.

The effect decreases with the distance of the disc, and varies with its nature. The maximum effect is produced with metals; with wood, glass, water, etc. it disappears. Babbage and Herschel have found that representing this action on copper at 100, the action on other metals is as follows: zinc 95, tin 46, lead 25, antimony 9, bismuth 2. Lastly, the effect is enfeebled if the disc presents breaks in the continuity, especially in the direction of the radii; but the same physicists have observed that it virtually regains the same intensity if these breaks have been soldered with any metal.

Faraday made an experiment the reverse of Arago's first observation; since the presence of a metal at rest stops the oscillations of a magnetic needle, the neighbourhood of a magnet at rest ought to stop the motion of a rotating mass of metal. Faraday suspended a cube of copper to a twisted thread, which was placed between the poles of a powerful electromagnet. When the thread was left to itself, it began to spin round with great velocity, but stopped the moment a powerful current passed through the electromagnet.

Faraday was the first to give an explanation of all these phenomena of magnetism by rotation. They depend on the circumstance that a magnet or a solenoid can induce currents in a solid mass of metal. In the above case the magnet induces currents in the disc when the latter is rotated; and conversely when the magnet is rotated while the disc is primarily at rest. Now these induced currents by their electrodynamic action tend to destroy the motion which gave rise to them; they are simple illustrations of Lenz's law; they act just in the same way as friction would do.

i. For instance, let AB (fig. 732) be a needle oscillating over a copper disc, and suppose that in one of its oscillations it goes in the direction of the arrows from N to M. In approaching the point M, for instance, it develops there a current in the opposite direction, and which therefore repels it; in moving away from N it produces currents which are of the same kind, and which therefore attract, and both these actions concur in bringing it to rest.

ii. Suppose the metallic mass turns from N towards M, and that the magnet is fixed; the magnet will repel by induction points such as N which are approaching A, and will attract M which is moving away; hence the motion of the metal stops, as in Faraday's experiment.

iii. If in Arago's experiment the disc is moving from N to M, N approaches A and repels it, while M moving away attracts it; hence the needle moves in the same direction as the disc.

If this explanation is true, all circumstances which favour induction will increase the dynamic reaction; and those which diminish the former will also lessen the latter. We know that induction is greater in good conductors, and that it does not take place in insulating substances; but we have seen that the needle is moved with a force which is less, the less the conducting powers of the disc, and it is not moved when the disc is of glass. Dove has found that there is no induction on a tube split lengthwise in which a coil is introduced.

In order to bring the oscillations of the needle of a galvanometer more quickly to rest, the wire is coiled upon a copper frame. Such an arrangement is called a *dampner*, and in practice it is frequently used.

**874. Induction by the action of the earth.**—Faraday discovered that terrestrial magnetism can develop induced currents in metallic bodies in motion, acting like a powerful magnet placed in the interior of the earth in the direction of the dipping needle, or, according to the theory of Ampère, like a series of electrical currents directed from east to west parallel to the magnetic equator. He first proved this by placing a long helix of copper wire covered with silk in the plane of the magnetic meridian parallel to the dipping needle; by turning this helix  $180^\circ$  round an axis perpendicular to its length in its middle, he observed that at each turn a galvanometer connected with the two ends of the helix was deflected. The apparatus depicted in fig. 733, and known as *Delesse's circle*, serves for showing the existence of terrestrial induced currents. It consists of a wooden ring, RS, about two feet in diameter, fixed to an axis, *ao*, about which it can be turned by means of a handle, M. The axis *oa* is itself fixed in a frame, PQ, movable about a

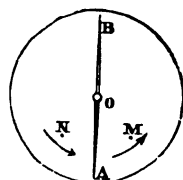

Fig. 732.



horizontal axis. By pointers fixed to these two axes the inclination towards the horizon of the frame  $PQ$ , and therefore of the axis  $oa$ , is indicated on a dial,  $b$ , while a second dial,  $c$ , gives the angular displacement of the ring. This ring has a groove in which is coiled a large quantity of insulated copper wire. The two ends of the wire terminate in a *commutator* analogous to that in Clarke's apparatus (881), the object of which is to pass the current always in the same sense, although its direction,  $SR$ , changes at each semi-revolution of the ring. On each of the rings of the commutator are two brass plates, which successively transmit the current to two wires in contact with the galvanometer. The axis  $oa$  being in the magnetic meridian, and the ring

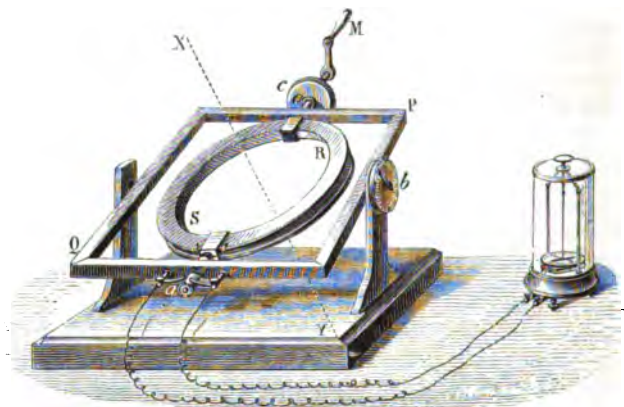

Fig. 733.

$RS$  at right angles to the direction  $XY$  of the dipping needle, if it is slowly rotated the needle of the galvanometer is deflected, and by its deflection indicates in the wire coiled on the ring an induced current whose intensity increases until it has been turned through  $90^\circ$ ; the deviation then decreases, and is zero when the ring has made a semi-revolution. If the rotation continues, the current reappears, but in a contrary direction, and attains a second maximum at  $270^\circ$ , becoming null again after a complete turn. When the axis  $oa$  is parallel to the dip there is no current.

**875. Induction of a current on itself. Extra current.**—If a closed circuit traversed by a voltaic current be opened, a scarcely perceptible spark is obtained, if the wire joining the two poles be short. Further, if the observer himself form part of the circuit by holding a pole in each hand, no shock is perceived unless the current is very intense. If, on the contrary, the wire is long, and especially if it makes a great number of turns, so as to form a bobbin with very close folds, the spark, which is inappreciable when the current is closed, acquires a great intensity when it is opened, and an observer in the circuit receives a shock which is the stronger the greater the number of turns.

Faraday has referred this strengthening of the current when it is broken to an inductive action which the current in each coil exerts upon the adjacent

coils : an action in virtue of which there is produced in the bobbin a direct induced current—that is, one in the same direction as the principal one. This is known as the *extra current*.

To show the existence of this current, at the moment of opening, Faraday arranged the experiment as seen in fig. 734. Two wires from the poles

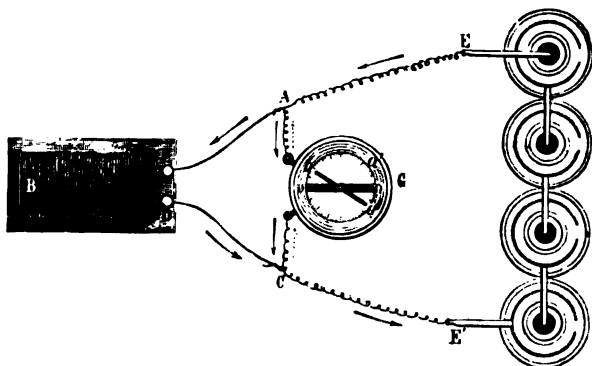

Fig. 734.

E E' of a battery are connected with two binding screws, D and F, with which are also connected the two ends of a bobbin, B, with a long fine wire, which offers therefore a great resistance. On the path of the wires at the points A and C are two other wires, which are connected with a galvanometer, G. Hence the current from the pole E branches at A into two currents, one which traverses the galvanometer, the other the bobbin, and both joining the negative pole E'.

The needle of the galvanometer being then deflected by the current which goes from A to C, it is brought back to zero, and kept there by an obstacle which prevents it from turning in the direction Ga, but leaves it free in the opposite direction. On breaking contact at E, it is seen that the moment the circuit is open the needle is deflected in the direction Ga'; showing a current contrary to that which passed during the existence of the extra current—that is, showing the current from C to A. But the battery current having ceased, the only remaining one is the current AFBDC A; and since in the part CA the current goes from C to A, it must traverse the entire circuit in the direction AFBDC—that is, the same as the principal current. This current, which thus appears when the circuit is opened, is the *extra current*.

876. **Extra current on opening and on closing.**—The coils of the spiral act inductively on each other, not merely on opening, but also on closing the current. Hence, in accordance with the general law of induction, each spiral acting on each succeeding one, induces a current in the opposite direction to its own—that is, an inverse current: this, which is the *extra current on closing*, or the *inverse extra current*, being of contrary direction to the principal one, diminishes its intensity, and lessens or suppresses the spark on closing.

When, however, the current is opened, each spire then acts inductively on each succeeding one, producing a current in the same direction as its own, and which therefore greatly heightens the intensity of the principal current. This is the *extra current on opening*, or *direct extra current*.

To observe the direct extra current, the conductor on which its effect is to be traced may be introduced into the circuit, by being connected in any suitable manner with the binding screws A and C in the place of the galvanometer.

It can thus be shown that the direct extra current gives violent shocks, bright sparks, decomposes water, melts platinum wires, and magnetises steel needles. Abria has found that the intensity of the extra current is about 0.72 of the principal current. The shock produced by the current may be tried by attaching the ends of the wire to two files, which are held in the hands. On moving the point of one file over the teeth of the other a series of shocks is obtained, due to the alternate opening and closing of the current.

The above effects acquire greater intensity when a bar of soft iron is introduced into the bobbin, or, what is the same thing, when the current is passed through the bobbin of an electromagnet; and still more is this the case if the core, instead of being massive, consists of a bundle of straight wires. Faraday explains this strengthening action of soft iron as follows: If inside the spiral there is an iron bar, when on opening the circuit the principal current disappears, the magnetism which it evokes in the bar disappears too; but the disappearance of this magnetism acts like the disappearance of the electrical current, and the disappearing magnetism induces a current in the same direction as the disappearing principal current, the effect of which is thus heightened.

In the experiments just described the effects of the two extra currents accompany those of the principal current. Edlund has devised an ingenious arrangement of apparatus by which the action of the principal current on the measuring instruments can be completely avoided, so that only that of the extra current remains. In this way he has arrived at the following laws:

- i. *The intensity of the currents used being the same, the extra currents obtained on opening and closing have the same electromotive force.*
- ii. *The electromotive force of the extra current is proportional to the intensity of the primary current.*

**877. Induced currents of different orders.**—Spite of their instantaneous character, induced currents can themselves, by their action on closed circuits, give rise to new induced currents, these again to others, and so on, producing *induced currents of different orders*.

These currents, discovered by Henry, may be obtained by causing to act on each other a series of bobbins, each formed of a copper wire covered with silk, and coiled spirally in one plane, like that represented in plate A, in fig. 729. The currents thus produced are alternately in opposite directions, and their intensity decreases in proportion as they are of a higher order.

**878. Properties of induced currents.**—Notwithstanding their instantaneous character, it appears from the preceding experiments that induced

currents have all the properties of ordinary currents. They produce violent physiological, luminous, calorific, and chemical effects, and finally give rise to new induced currents. They also deflect the magnetic needle, and magnetise steel bars when they are passed through a copper wire coiled in a helix round the bars.

The intensity of the shock produced by induced currents renders their effects comparable to those of electricity in a state of tension.

The direct induced current and the inverse induced current have been compared as to three of their actions : the violence of the shock, the deflection of the galvanometer, and the magnetising action on steel bars. In these respects they differ greatly : they are about equal in their action on the galvanometer ; but while the shock of the direct current is very powerful, that of the inverse current is scarcely perceptible. The same difference prevails with reference to the magnetising force. The direct current magnetises to saturation, while the inverse current does not magnetise.

879. **Laws of induced currents.**—In his special treatise on induction, Matteucci has deduced from his own researches, and from those of Faraday, Lenz, Dove, Abria, Weber, Marianini, and Felici, the following laws in reference to induced currents :

i. *The intensity of induced currents is proportional to that of the inducing currents.*

ii. *This intensity is proportional to the product of the length of the inducing and induced currents.*

iii. *The electromotive force developed by a given quantity of electricity is the same whatever be the nature, section, or shape of the inducing circuit.*

iv. *The electromotive force developed by the induction of a current on any given conducting circuit is independent of the nature of the conductor.*

v. *The development of induction is independent of the nature of the insulating body interposed between the induced and inducing circuit.*

This latter law is in disaccord with the experiments of Faraday, on the induction of statical electricity (725).

#### APPARATUS FOUNDED ON INDUCTION.

880. **Magneto-electrical apparatus.**—After the discovery of magneto-electrical induction, several attempts were made to produce an uninterrupted series of sparks by means of a magnet. Apparatus for this purpose were devised by Pixii and Ritchie, and subsequently by Saxton, Ettingshausen, and Clarke. Fig. 735 represents that invented by Clarke. It consists of a powerful horse-shoe magnetic battery, A, fixed against a vertical wooden support. In front of this there are two bobbins, B B', movable round a horizontal axis. These bobbins are coiled on two cylinders of soft iron joined at one end by a plate of soft iron, V, and at the other by a similar plate of brass. These two plates are fixed on a copper axis, terminated at one end by a commutator, *qi*, and at the other by a pulley, which is moved by an endless band passing round a large wheel, which is turned by a handle.

Each bobbin consists of about 1,500 turns of very fine copper wire

covered with silk. One end of the wire of the bobbin B is connected to the axis of rotation with one end of the wire of the bobbin B', and the two other ends of these wires terminate in a copper ferrule or washer, *g*, which is fixed to the axis, but is insulated by a cylindrical envelope of ivory. In

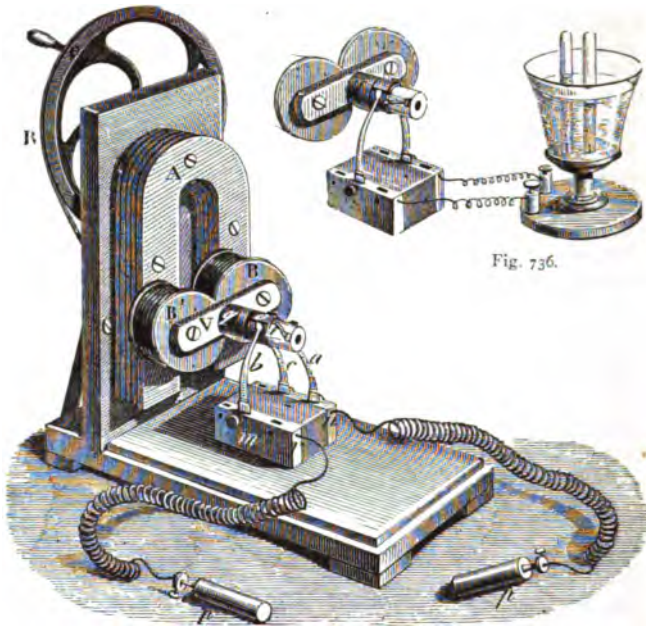

Fig. 736.

Fig. 735.

order that in each wire the induced current may be in the same direction, it is coiled on the two bobbins in different directions—that is, one is right-handed, the other left-handed.

When now the electromagnet turns, its two branches become alternately magnetised in contrary directions under the influence of the magnet A, and in each wire an induced current is produced, the direction of which changes at each half-turn.

Let us follow one of the bobbins—B, for instance—while it makes a complete revolution in front of the poles *a* and *b* of the magnet; calling the poles of the electromagnet successively *a'* and *b'*. Let us further consider the latter when it passes in front of the north pole of the magnetic battery (fig. 737). The iron has then a south pole in which, as we know, the Ampèrian currents move like the hands of a watch. The contrary seems to be represented in fig. 737, but it must be remembered that the bobbins are seen here as they are in fig. 735; and hence, when viewed at the end which grazes the magnet, the Ampèrian currents seem to turn like the hands of a watch. These currents act inductively on the wire of the bobbin, producing a current in the same direction (879, iii.), for the bobbin moves away from

the pole *a*, its soft iron is demagnetised, and the Ampèrian currents cease (870). The intensity of the induced current in the bobbin decreases, until the right line joining the axes of the two bobbins is perpendicular to that which joins the poles *a* and *b* of the bar. There is now no magnetism in the

Fig. 737.

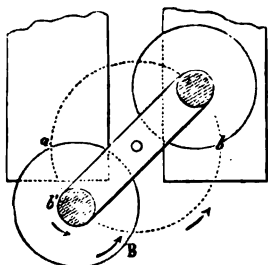

Fig. 738.

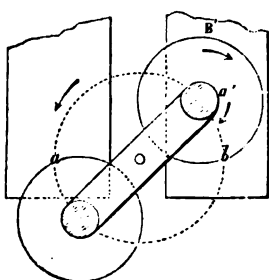
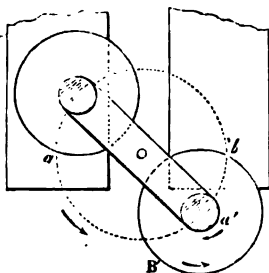

Fig. 739.

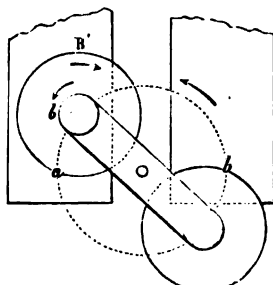

Fig. 740.

bar, but quickly approaching the pole *b*. its soft iron is then magnetised in the opposite direction—that is, it becomes a north pole (fig. 738). The Ampèrian currents are then in the direction of the arrow *a'*; and as they are commencing, they develop in the wire of the bobbin an inverse current (870), which is in the same direction as that developed in the first quarter of the revolution. Moreover, this second current adds itself to the first; for while the bobbin moves away from *a*, it approaches *b*. Hence, during the lower half revolution from *a* to *b*, the wire was successively traversed by two induced currents in the same direction, and if the rotatory motion is sufficiently rapid, we might admit during this half-revolution the existence of a single current of the wire.

The same reasoning applied to the figures 739 and 740 will show that during the upper half-revolution the wire of the bobbin B is still traversed by a single current, but in the opposite direction to that of the lower half revolution. What has been said about the bobbin B applies obviously to the bobbin B'; yet, as one of these is right-handed and the other left-handed, during each upper or lower half-revolution the currents are constantly in the same direction in the two bobbins. At each successive half-revolution they

both change, but are in the same direction as regards each other; the term direction having here reference to figs. 737-740.

881. **Commutator.**—The object of this apparatus (fig. 741), of which fig. 742 is a section, is to bring the two alternating currents always in the same direction. It consists of an insulating cylinder of ivory or ebony, *J*, in the

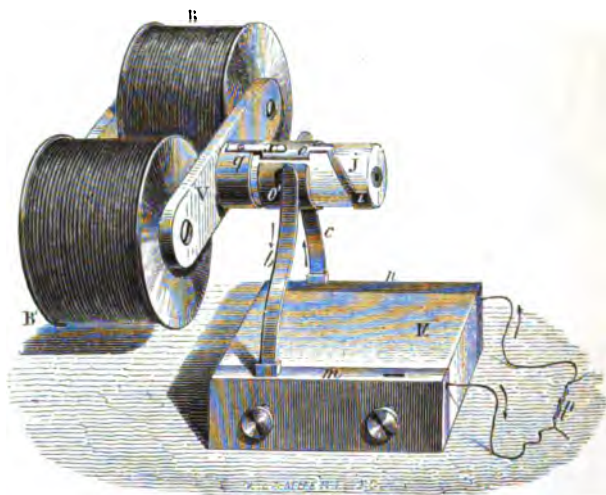

Fig. 741.

axis of which is a copper cylinder, *k*, of smaller diameter, fixed to the armature *V*, and turning with the bobbins. On the ivory cylinder is first a brass ferrule, *g*, and in front of it two half-ferrules, *o* and *o'*, also of brass and completely insulated from one another. The half-ferrule *o* is connected with the ferrule *g* by a tongue, *x*. On the sides of a block of wood, *M*, there are two brass plates, *m*, *n*, on which are screwed two elastic springs, *b* and *c*, which

press successively on the half-ferrules *o* and *o'*, when rotation takes place.

We have already seen that the two ends of the wire of the bobbin, those in the same direction with respect to the currents passing through them at any time, which will be found to be those farthest away from the armature *V*, terminate in the metallic axis *k*, and therefore

on the half-ferrule *o'*; while the other two ends, both in the same direction with respect to the current, are joined to the ferrule *g*, and therefore to the

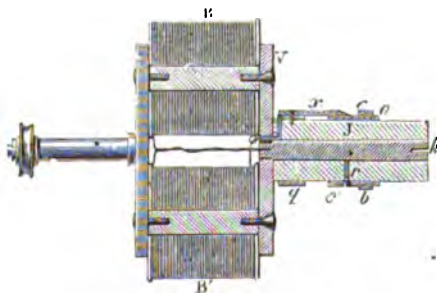

Fig. 742.

half ferrule  $o$ . It follows that the pieces  $oo'$  are constantly poles of alternating currents which are developed in the bobbins; and as these are alternately in contrary directions, the pieces  $o$  and  $o'$  are alternately positive and negative. Now, taking the case in which the half-ferrule  $o'$  is positive, the current descends by the spring  $b$ , follows the plate  $m$ , arrives at  $n$  by the joining wire  $p$ , ascends in  $c$ , and is closed by contact with the piece  $o$ ; then, when, in consequence of rotation,  $o$  takes the place of  $o'$ , the current retains the same direction; for, as it is then reversed in the bobbins,  $o$  has become positive and  $o'$  negative, and so forth as long as the bobbin is turned.

With the two springs  $b$  and  $c$  alone, the opposite currents from the two pieces  $o$  and  $o'$  could not unite when  $m$  and  $n$  are not joined; this is effected by means of a third spring,  $a$  (fig. 735), and of two appendices,  $i$ , only one of which is visible in the figure. These two pieces are insulated from one another on an ivory cylinder, but communicate respectively with the pieces  $o$  and  $o'$ . As often as the spring  $a$  touches one of these pieces it is connected with the spring  $b$ , and the current is closed, for it passes from  $b$  to  $a$ , and then reaches the spring  $c$  by the plate  $n$ . On the contrary, as long as the spring  $a$  does not touch one of these appendices the current is broken.

For physiological effects the use of the spring  $a$  greatly increases the intensity of the shocks. For this purpose two long spirals of copper wire with handles,  $p$  and  $p'$ , are fixed at  $n$  and  $m$ . Holding the handles in the hands, so long as the spring  $a$  does not touch the appendices  $i$ , the current passes through the body of the experimenter, but without appreciable effect; while each time that the plate  $a$  touches one of the appendices  $i$ , the current, as we have seen above, is closed by the pieces  $b$ ,  $a$ , and  $c$ , and ceasing then to pass through the wires  $np$ ,  $mp'$ , there is produced in this and through the body a direct extra-current which causes a violent shock.

This is renewed at each half-turn of the electromagnet, and its intensity increases with the velocity of the rotation. The muscles contract with such force that they do not obey the will, and the two hands cannot be detached. With an apparatus of large dimensions a continuance of the shock is unendurable.

All the effects of voltaic currents may be produced by the induced current of Clarke's machine. Fig. 736 shows how the apparatus is to be arranged

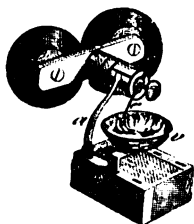

Fig. 743.



Fig. 744.

for the decomposition of water. The spring  $a$  is suppressed, the current being closed by the two wires which represent the electrodes.

For physiological and chemical effects the wire rolled on the bobbins is



fine, and each about 500 to 600 yards in length. For physical effects, on the contrary, the wire is thick, and there are about 25 to 35 yards on each bobbin. Figs. 743 and 744 represent the arrangement of the bobbins and the commutator in each case. The first represents the inflammation of ether, and the second the incandescence of a metallic wire,  $\phi$ , in which the current from the plate  $a$ , to the plate  $c$ , always passes in the same direction.

Pixii's and Saxton's electromagnetic machine differs from Clarke's in having the electromagnet fixed while the magnet rotates.

Wheatstone has recently devised a compendious form of the magneto-electrical machine, for the purpose of using the induced spark in firing mines (769).

**882. Magneto-electrical machine.**—The principle of Clarke's apparatus has received in the last few years a remarkable extension in large magneto-electrical machines, by means of which mechanical work is transformed into powerful electric currents by the inductive action of magnets on bobbins in motion.

The first machine of this kind was invented by Nollet, in Brussels, in 1850; fig. 745 represents an improved form. It consists of a cast-iron frame,  $5\frac{1}{2}$  feet in height, on the circumference of which eight series of five powerful horse-shoe magnetic batteries, A, A, A, are arranged in a parallel order on wooden cross-pieces. These batteries, each of which can support from 120 to 130 pounds, are so arranged that, if they are considered either parallel to the axis of the frame, or in a plane perpendicular to this axis, opposite poles always face one another. In each series the outside batteries consist of three magnetised plates, while the three middle ones have six plates, because they act by both faces, while the first only acts by one.

On a horizontal iron axis going from one end to the other of the frame four bronze wheels are fixed, each corresponding to the intervals between the magnetic batteries of two vertical series. There are 16 bobbins on the circumference of each of these—that is, as many as there are magnetic poles in each vertical series of magnets. These bobbins, represented in fig. 747, differ from those of Clarke's apparatus, in having, instead of a single wire, 12 wires each  $11\frac{1}{2}$  yards in length, by which the resistance is diminished. The coils of these bobbins are insulated by means of bitumen dissolved in oil of turpentine. These are not rolled upon solid cylinders of iron, but on two iron tubes, split longitudinally; this device renders the magnetisation and demagnetisation more rapid when the bobbins pass in front of the poles of the magnet. Further, the discs of copper which terminate the bobbins are divided in the direction of the radius, in order to prevent the formation of induced currents in these discs. The four wheels being respectively provided with 16 bobbins each, there are altogether 64 bobbins arranged in 16 horizontal series of four, as seen at D, on the left of the frame. The length of the wire on each bobbin being 12 times  $11\frac{1}{2}$  yards, or 138 yards, the total length in the whole apparatus is 64 times 138 yards, or 8,832 yards.

The wires are coiled on all the bobbins in the same direction, and not only on the same wheel, but on all four, all wires are connected with one another. For this purpose the bobbins are joined, as shown in fig. 746; on the first wheel the twelve wires of the first bobbin,  $x$ , are connected on a piece of mahogany fixed on the front face of the wheel with a plate of copper,

*m*, connected by a wire, *O*, with the centre of the axis which supports the wheels. At the other end, on the other face of the wheel, the same wires are soldered to a plate indicated by a dotted line which connects them with the bobbin *y*; from this they are connected with the bobbin *z* by a plate, *i*, and

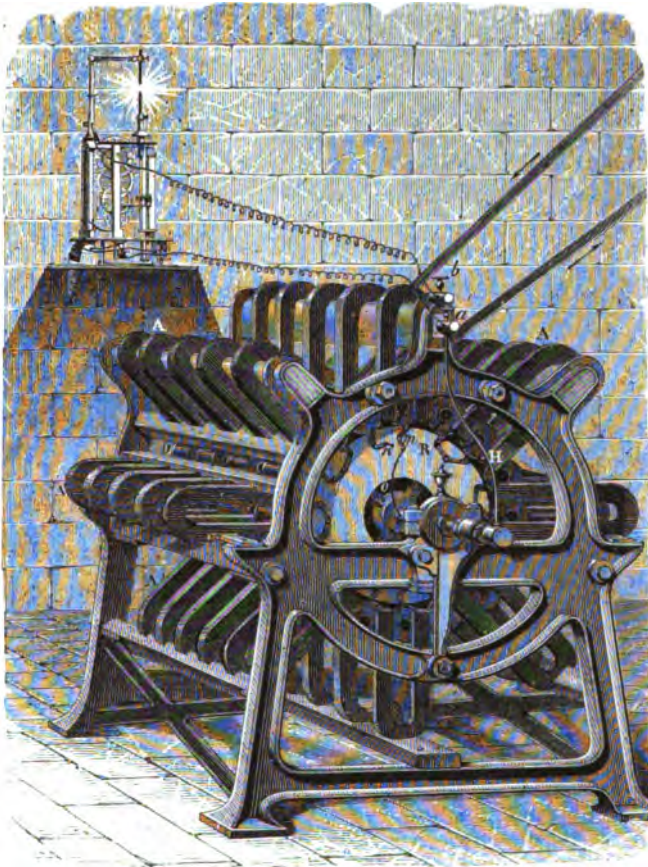

Fig. 745.

so on, for the bobbins *l*, *u* . . . up to the last, *v*. The wires of this bobbin terminate in a plate, *n*, which traverses the first wheel, and is soldered to the wires of the first bobbin of the next wheel, on which the same series of connections is repeated; these wires pass to the third wheel, thence to the fourth, and so on, to the end of the axis.

The bobbins being thus arranged, one after another, like the elements of a battery connected in a series (801), the electricity has high potential. But the bobbins may also be arranged by connecting the plates alternately, not

with each other, but with two metal rings in such a manner that all the ends of the same name are connected with the same ring. Each of these rings is



Fig. 746.



Fig. 747.

then a pole, and this arrangement may be used where a high degree of potential is not required.

From these explanations it will be easy to understand the manner in which electricity is produced and propagated in this apparatus. An endless band receiving its motion from a steam-engine, passes round a pulley fixed at the end of the axis which supports the wheels and the bobbins, and moves the whole system with any desired rapidity. Experience has shown that to obtain the greatest degree of light, the most suitable velocity is 235 revolutions in a minute. During this rotation, if we at first consider a single bobbin, the tube of soft iron on which it is coiled, in passing in front of the poles of the magnet, undergoes at its two ends an opposite induction, the effects of which are added, but change from one pole to another. As these tubes, during one rotation, pass successively in front of sixteen poles alternately of different names, they are magnetised eight times in one direction, and eight times in the opposite direction. In the same time there are thus produced in the bobbin eight direct induced currents and eight inverse induced currents; in all, sixteen currents in each revolution. With a velocity of 235 turns in a minute, the number of currents in the same time is  $235 \times 16 = 3,760$  alternately in opposite directions. The same phenomenon is produced with each of the 64 bobbins; but as they are all coiled in the same direction and are connected with each other, their effects accumulate, and there is the same number of currents, but they are more intense.

To utilise these currents in producing an intense electric light, the communications are made as shown in fig. 748. On the posterior side the last bobbin,  $x'$ , of the fourth wheel terminates by a wire,  $G$ , on the axis  $MN$ , which supports the wheels: the current is thus conducted to the axis, and thence over all the machine, so that it can be taken from any desired point. In the front the first bobbin,  $x$ , of the first wheel communicates by the wire  $O$ , not with the axis itself but with a steel cylinder,  $c$ , fitted in the axis, from which, however, it is insulated by an ivory collar. The screw  $e$ , to which the wire  $O$  is attached, is likewise insulated by a piece of ivory. From the cylinder  $c$  the current passes to a fixed metallic piece,  $K$ , from which it passes to the wire  $H$ , which transmits it to the binding screw  $a$  of fig. 745. The binding screw  $b$  communicates with the framework, and therefore with

the wire of the last bobbin,  $x'$  (fig. 748). From the two binding screws  $a$  and  $b$  the current is conducted by means of two copper wires to two charcoals, the distance of which is regulated by means of an apparatus analogous in principle to that already described (811).

In this machine the currents are not rectified so as to be in the same direction; hence each carbon is alternately positive and negative, and in

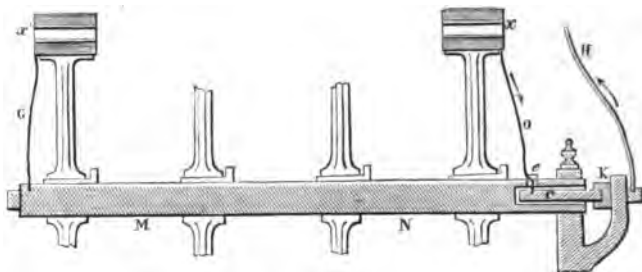

Fig. 748.

act they are consumed with equal rapidity. Experiment has shown that, when these currents are applied to produce the electric light, it is not necessary they should be in the same direction; but when they are to be used for electrometallurgy, or for magnetising, they must be rectified, which is effected by means of a suitable commutator.

The light produced by the magneto-electrical machine is very intense; with a machine of four wheels the light obtained is equal to that of 150 Carcel lamps. A machine of six wheels gives a light equal to 200 Carcel lamps.

Serrin has constructed a new regulator for this light, which, like the older ones, brings the charcoals together in proportion as they become used; and further removes them when they are in contact. It contains no clockwork motion, and is worked by the weight of one of its pieces.

This light, which requires no other expenditure than that of a single horse-power to turn the coils when there are not more than four of them, is advantageously used for signalling by night on large vessels, and for light-houses. One of these, constructed by Holmes, is now in use at the South Foreland lighthouse.

883. **Siemens' armature.**—Siemens has devised an armature or bobbin for magneto-electrical machines, in which the insulated wire is wound longitudinally on the core, instead of transversely, as is usually the case.

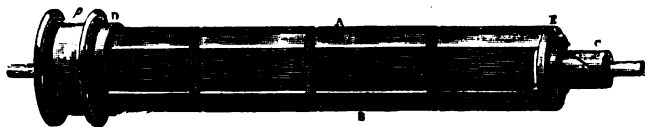

Fig. 749.

It consists of a soft iron cylinder, AB (fig. 749), from one foot to three feet in length, according to circumstances. A deep groove is cut on the outer

M M

length of this core and on the ends, in which is coiled the insulated wire as in a multiplier. To the two ends of the cylinder brass discs, E and D, are secured. With E is connected a commutator, C, consisting of two pieces of steel insulated from each other and connected respectively with the two ends of the wire. On the other disc is a pulley, round which passes a cord, so that the bobbin moves very rapidly on the two pivots.

When a voltaic current circulates in the wire, the two cylindrical segments, A and B, are immediately magnetised, one with one polarity and the other with the opposite. On the other hand, if, instead of passing a voltaic current through the wire of the bobbin, the bobbin itself be made to rotate rapidly between the opposite poles of magnetised masses, as the segments A and B become alternately magnetised and demagnetised, their induction produces in the wire a series of currents alternately positive and negative, as in Clarke's apparatus (881). When these currents are collected in a commutator which adjusts them—that is, sends all the positive currents on one spring and all the negative on another—these springs become electrodes from one of which positive electricity starts and from the other negative. If these springs are connected by a conductor, the same effects are obtained as when the two poles of a battery are united.

Siemens has constructed magneto-electrical machines in which this armature is utilised. It has the great advantage that a large number of small magnets may be used instead of one large one. As, weight for weight, the former possesses greater magnetic force than the latter, they can be made more economically. And as the armature is always very near the magnets, it receives greater momentum, and is more rapidly changed.

884. **Wild's magneto-electrical machine.**—Mr. Wild has recently constructed a magneto-electrical machine, in which Siemens' armature is used along with a new principle—that of the multiplication of the current. Instead of utilising directly, the current produced by the induction of a magnet, Mr. Wild passes it into a strong electromagnet, and by the induction of this latter a more energetic current is obtained.

This machine consists first of a battery of 12 to 16 magnets P (fig. 750), each of which weighs about 3 pounds, and can support about 20 pounds. Between the poles of the magnets two soft iron keepers, CC, are arranged, separated by a brass plate, O. These three pieces are joined by bolts, and the whole compound keeper is perforated longitudinally by a cylindrical cavity, in which works a Siemens' armature, *u*, about 2 inches in diameter. The wire of this armature terminates in a commutator, which leads the positive and negative currents to two binding screws, *a* and *b*. This commutator is represented on a larger scale in fig. 752. At the other end is a pulley by which the armature can be turned at the rate of 25 turns in a second. The wire on the armature is 20 yards long.

Below the support for the magnets and their armatures are two large electromagnets, BB. Each consists of a rectangular soft iron plate, 36 inches in length by 26 in breadth and  $1\frac{1}{4}$  inch thick, on which are coiled about 1,600 feet of insulated copper wire. The wires of these electromagnets are joined at one end, so as to form a single circuit of 3,200 feet. One of the other ends is connected with the binding screw *a* and the other with *b*. At the

top the two plates are joined by a transverse plate of iron so as to form a single electromagnet.

At the bottom of the electromagnets BB are two iron armatures separated by a brass plate, O, and in the entire length is a cylindrical channel in which works a Siemens' armature *m* as above : this armature, however, is above a

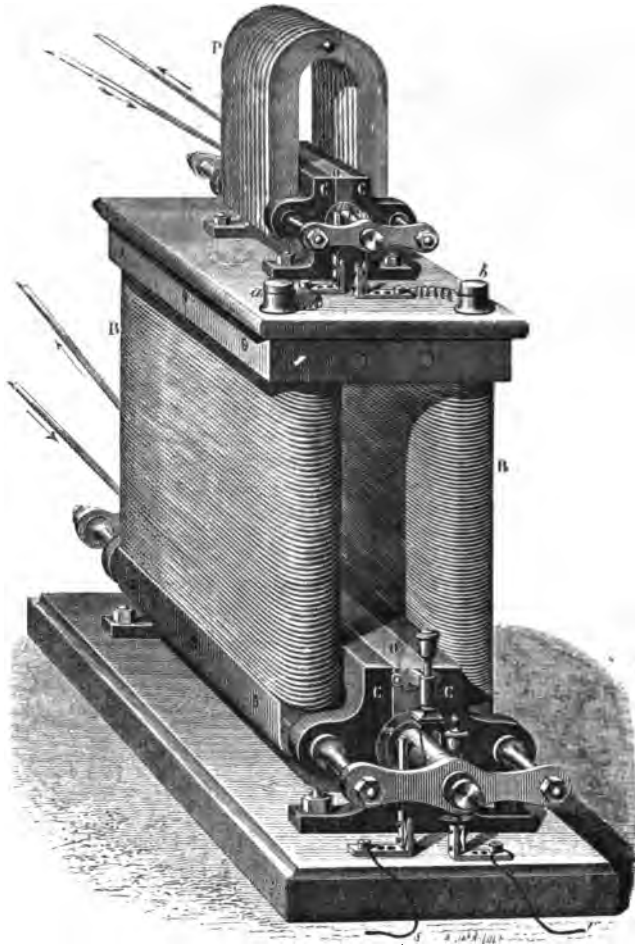

Fig. 750.

yard in length, nearly 6 inches in diameter, and its wire is 100 feet long. The ends are connected with a commutator, from which the adjusted currents pass to two wires, *r* and *s*. The armature *m* is rotated at the rate of 1,700 turns in a minute.

Fig. 751 shows on a larger scale a cross section of the bobbin  $m$  of the armatures CC and of the plates AA, on which is coiled the wire of the electromagnets BB.

These details being premised, the following is the working of the machine. When the armatures  $n$  and  $m$  are rotated by means of a steam

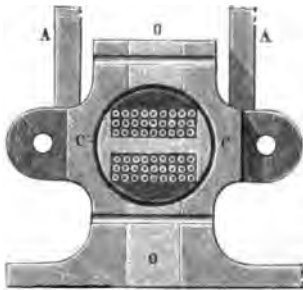

Fig. 751.



Fig. 752.

engine with the velocity mentioned, the magnets produce in the first armature induced currents, which, adjusted by the commutator, pass into the electromagnet BB, and magnetise it. But as these impart to the lower armatures CC opposite polarities, the induction of these latter produces in the armature  $m$  a series of positive and negative currents far more powerful than those of the upper armature; so that when these are adjusted by a commutator and directed by the wires  $r$  and  $s$ , very powerful effects are obtained.

These effects are still further intensified if, as Mr. Wild has done, the adjusted current of the armature  $m$  is passed into a second electromagnet, whose armatures surround a third and larger Siemens' armature turning with the two others. A current is thus obtained which melts an iron wire a foot long and more than 0.2 inches in diameter.

885. **Ladd's dynamomagnetic machine.**—Mr. Ladd has invented a very remarkable dynamomagnetic machine. It consists of two Siemens' armatures, rotating with great velocity, and of two iron plates, AA (fig. 753) surrounded by an insulated copper wire. Ladd's machine differs from that of Wild in the following respects :

i. There are no permanent magnets : ii. the electromagnets BB are not joined so as to form a single electromagnet, but are two distinct electromagnets, each having at the end two hollow cylinders, CC', in which are fitted two Siemens' armatures,  $m$  and  $n$ ; the current of the armature  $n$  passing round the electromagnets reverts to itself. This reaction of the current upon itself is an essential feature of the machine; it is an application of a principle announced simultaneously by Sir C. Wheatstone and by Mr. Siemens. The wire of the armature  $m$  is independent, and passes into the apparatus which is to utilise the current—for instance, two carbon points, D.

The machine being thus arranged, if a voltaic current be passed once for all through the electromagnets BB, it magnetises the plates AA and their

keepers, which by their reciprocal action retain a quantity of remanent magnetism sufficient to work the machine. If, then, the armatures  $m$  and  $n$  be rotated by means of two bands passing round a common drum, the magnetism of the hollow cylinders  $CC'$  acting upon the armature  $n$ , excites induction currents, which, adjusted by a commutator, pass round the electro-magnets  $BB$ , and more strongly magnetise the cylinders or shoes  $CC'$ . These in their turn reacting more powerfully on the armature  $n$ , strengthen

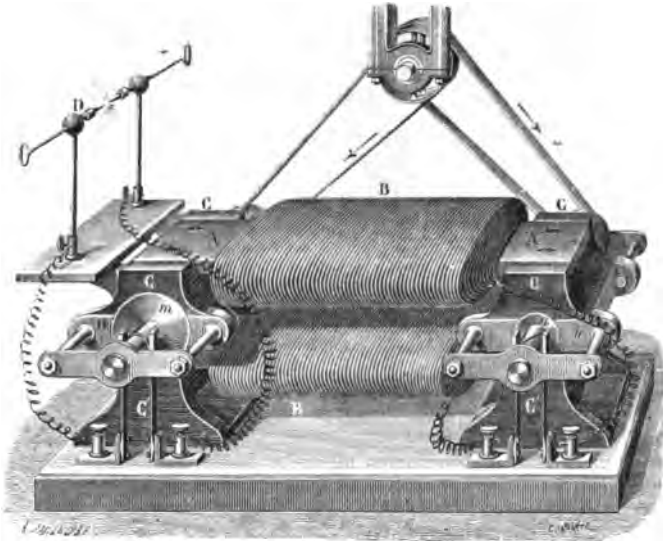

Fig. 753.

the current; we thus see that  $n$  and  $B$  continually and mutually strengthen each other as the velocity of the rotation increases. Hence as the iron of the armature  $m$  becomes more and more strongly magnetised under the influence of the electromagnets  $BB$ , a gradually more intense induced current is developed in this armature, which is directed, commutated or not, according to the use for which it is designed.

In a machine which Mr. Ladd exhibited at the Paris Exhibition of 1867 the plates  $AA$  were only 24 inches in length by 12 inches in width. With these small dimensions the current is equal to 25 to 30 Bunsen's cells. It can work the electric light and keep incandescent a platinum wire a metre in length and 0.5 mm. in diameter.

The above form of the machine is worked by steam power. Mr. Ladd has devised a more compact form, which may be worked by hand. This is represented in fig. 754. The two armatures are fixed end to end, and the coils are wound on it at right angles to each other, as shown in the figure. The current from this can raise to white heat 18 inches of platinum wire 0.01 in. in thickness, and with an inductorium (887) containing 3 miles of secondary wire 2 in. sparks can be obtained.



Both Ladd's and Wild's machines are liable to the objection of requiring to be rotated at a rapid rate. The armatures become heated by the repeated development of induction currents. This has been remedied by Mr. Ladd, who has introduced into the shoes or hollow cylinders several apertures through which a stream of cold water is made to flow. Before they can be

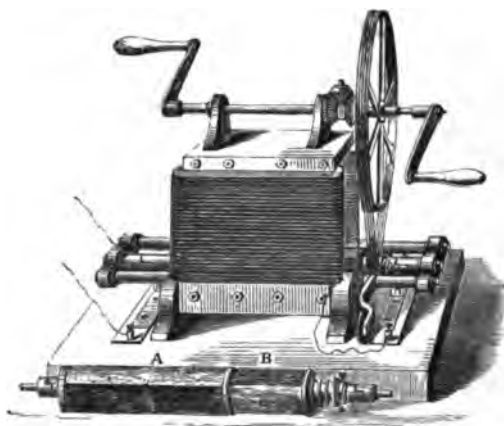

Fig. 754.

applied industrially, their velocity must be reduced, either by multiplying the number of Siemens' armatures or modifying their arrangement.

These machines furnish a remarkable instance of the transformation of mechanical force into electricity, light, and heat (284, 483).

886. **Gramme's magneto-electrical machine.**—The magneto-electrical machines which have hitherto been described are all open to the objection that they only give momentary currents, alternately positive and negative. These currents may indeed be used for lighting and for physiological purposes, but for other applications, such as for electro-plating, they must be *rectified*; that is, by means of a commutator, they must be sent always in the same direction. This, however, is in all cases accompanied by a certain loss of electricity, and sparks are produced which rapidly wear away the armatures of the commutators.

These inconveniences are not met with in an apparatus invented by M. Gramme, of which fig. 755 is a representation about  $\frac{1}{3}$ th of the real size. On a base is a powerful magnetic battery, between the limbs of which an axle is rotated by means of a pulley and an endless band. On this axle, and in the same plane as the branches of the magnet, is a soft iron ring, on which are wound 35 coils of insulated copper wire, each having nearly 300 turns. In each one the wire is bent inside the ring, and is soldered to an insulated piece of brass. It is then again folded on the ring so as to form a second coil. From this it passes to a piece of brass similar to the first, and so on, forming a continuous conductor divided into 35 identical bobbins.

All the pieces of brass to which the copper wire is soldered are insulated

from the apparatus, and form a bundle at *c* around the axis. There, on the same horizontal diameter of the ring, one part of these pieces is in contact with two brass discs, *m* and *n*, represented in fig. 756, which shows below them the bobbins and their accessories. These two discs slide on their

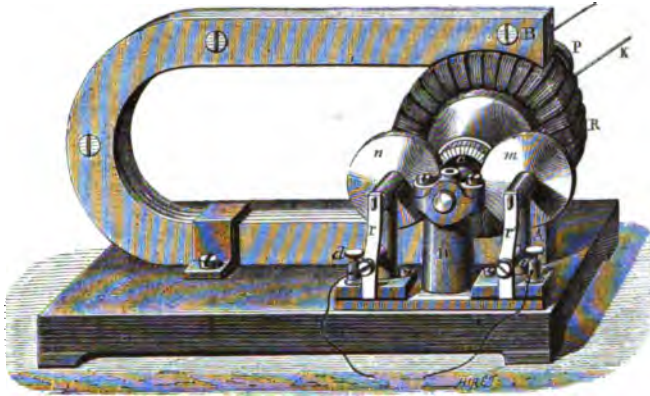

Fig. 755.

supports in the direction of the axis, and two springs press them against the pieces *c*.

Suppose now that the ring with its coils turns from right to left in passing under the pole B of the magnet, the upper part of the ring acquires a polarity the reverse of that of the ring, and its magnetisation develops a current the inverse of the Ampérian currents (870) in the coils which approach the pole, and direct in those which recede from it. Hence, if the current formed on the right near the middle part, R, of the system is positive, that developed in the opposite region is negative.

In front of the pole A a similar effect is produced, but here the polarity of A being the opposite of that of B, the inverse current from below towards R is positive, and the current on the left is negative.

Thus there are continually two positive currents proceeding from the upper and lower coils towards the medial region R, and two negative currents directed towards the opposite sides. These currents pass thence to the corresponding pieces *c*, whence they are collected by the discs *m* and *n*, which transmit them to the two binding screws *a* and *b*. A continuous current is thus produced which is always in the same direction, *m* being the positive pole and *n* the negative pole. If the rotation is in the opposite direction, the poles are reversed.



Fig. 756.

This apparatus, though small in size—9 inches in height—is very powerful; it can decompose water and heat to redness an iron wire 20 centimetres in length and a millimetre in diameter. Its power increases with the velocity of its rotation up to a limit of 700 to 800 turns in a minute, and its effects vary according as the wire of the bobbins is thick and short or fine and long.

Hagenbach made a series of experiments with a larger machine of this kind, which was worked by a small turbine fed by the water supply of Basel. He found that the strength of the current yielded by the machine was very nearly proportional to the speed of the rotation. The machine was intended for producing the electric light for lecture illustrations; and it was found that the intensity of the light increased somewhat more rapidly than in proportion to the number of turns of the machine. With a velocity of 1,800 turns in a minute, light equal to that of 567 normal paraffine candles was attained; each candle had a diameter of 21 mm., and the height of its flame was 41 mm. The work required for the production of this velocity was equal to rather more than one horse power; and the mere cost of producing this was somewhat less than three shillings an hour. Hagenbach's experiments, as well as some by Tresca, show that large machines are more economically worked than small ones.

887. **Inductorium. Ruhmkorff's coil.**—These are arrangements for producing induced currents, in which a current is induced by the action of an electric current, whose circuit is alternately opened and closed in rapid succession. These instruments, known as *inductoriums* or *induction coils*, present considerable variety in their construction, but all consist essentially of a hollow cylinder in which is a bar of soft iron, or bundle of iron wires, with two helices coiled round it, one connected with the poles of a battery, the current of which is alternately opened and closed by a self-acting arrangement, and the other serving for the development of the induced current. By means of these apparatus, with a current of three or

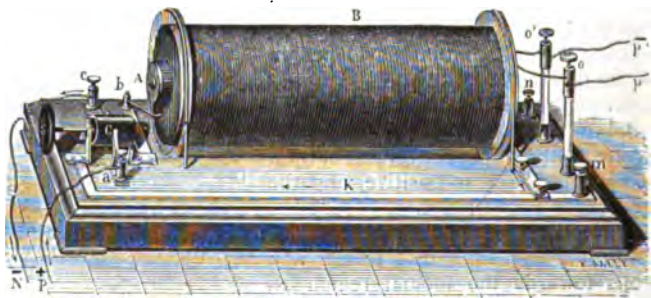

Fig. 757.

four Grove's cells, physical, chemical, and physiological effects are produced equal to and superior to those obtainable with electrical machines and even the most powerful Leyden batteries.

Of all the forms those constructed by Ruhmkorff are the most powerful.

Fig. 757 is a representation of one, the coil of which is about 14 inches in length. The *primary* or *inducing* wire is of copper, and is about 2 mm. in diameter and 40 or 50 yards in length. It is coiled directly on a cylinder of cardboard, which forms the nucleus of the apparatus, and is enclosed in an insulating cylinder of glass, or of caoutchouc. On these is coiled the *secondary* or *induced* wire, which is also of copper, and is about  $\frac{1}{3}$  mm. in diameter. A great point in these apparatus is the insulation. The wires are not merely insulated by being in the first case covered with silk, but each individual coil is separated from the rest by a layer of melted shellac. The length of the secondary wire varies greatly; in the largest size hitherto made it is as much as 280 miles. With these great lengths the wire is thinner, about  $\frac{1}{3}$  mm. The thinner and longer the wire the higher the potential of the induced electricity.

The following is the working of the apparatus. The current arriving by the wire P at a binding screw, *a*, passes thence into the commutator C, to be afterwards described (fig. 759), thence by the binding screw *b* it enters the primary wire, where it acts inductively on the secondary wire; having traversed the primary wire, it emerges by the wire *s* (fig. 758). Following the direction of the arrows, it will be seen that the current ascends in the binding screw *i*, reaches an oscillating piece of iron, *o*, called the *hammer*, descends by the *anvil* *h*, and passes into a copper plate, K, which takes it to the commutator C. It goes from there to the binding screw *c*, and finally to the negative pole of the battery by the wire N.

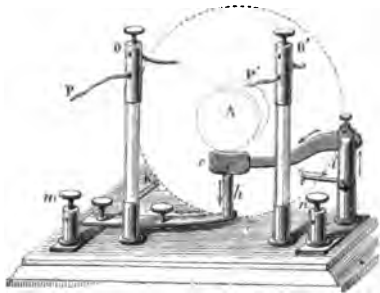

Fig. 758.

The current in the primary wire only acts inductively on the secondary wire (870), when it opens or closes, and hence must be constantly interrupted. This is effected by means of the oscillating hammer *o* (fig. 758). In the centre of the bobbin is a bundle of soft iron wires, forming together a cylinder a little longer than the bobbin, and thus projecting at the end as seen at A. When the current passes in the primary wire, this hammer *o* is attracted; but immediately, there being no contact between *o* and *h*, the current is broken, the magnetisation ceases, and the hammer falls; the current again passing, the same series of phenomena recommences, so that the hammer oscillates with great rapidity.

**888. Condenser.**—In proportion as the current passes thus intermittently in the primary wire of the bobbin, at each interruption an induced current, alternately direct and inverse, is produced in the secondary wire. But as this is perfectly insulated, the induced current acquires such a strength as to produce very powerful effects. Fizeau increased this strength still more by interposing a condenser in the primary circuit.

This condenser (fig. 759) consists of sheets of tinfoil placed over each other and insulated by larger sheets of stout paper, *v*, soaked in paraffine or resin. The sheets of tinfoil project at the end of the paper, one set at *s s' s''*,

and the other at the other end, at  $e' e''$ , so that when joined by a binding screw the odd numbers form one coating of a condenser, and the even numbers the other coating.

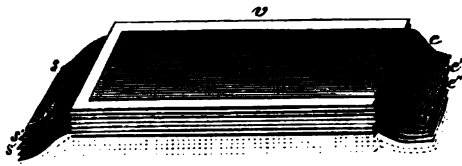

Fig. 759.

In large condensers, the surface of each condenser is as much as 75 square yards. The whole being placed in a box at the base of the apparatus, one of the coatings, the positive, is connected with the binding screw  $i$ , which receives the current on emerging from the bobbin; and the other, the negative, is connected with the binding screw  $m$ , which communicates by the plate K with the commutator C, and with the battery.

To understand the effect of the condenser, it must be observed that at each break of the inducing current an extra current is produced in the same direction, which, continuing in a certain manner, prolongs its duration. It is this extra current which produces the spark that passes at each break between the hammer and the anvil; when the current is strong this spark rapidly alters the surface of the hammer and anvil, though they are of platinum. By interposing the condenser in the inducing circuit, the extra current, instead of producing so strong a spark, passes into the condenser; the positive electricity in the coating connected with  $i$ , and the negative in that connected with  $m$ . But the opposite electricities combining quickly by the thick wire of the primary coil, by the battery and the circuit CK $m$ , give rise to a current contrary to that of the battery, which instantaneously demagnetises the bundle of soft iron: the induced current is thus shorter and more intense. The binding screws  $m$  and  $n$  on the base of the apparatus are for receiving this extra current.

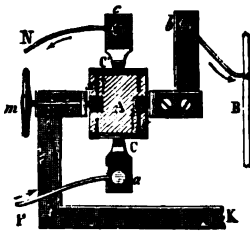

Fig. 760.

The *commutator* or *key* serves to break contact or send the current in either direction. The section in fig. 760 is entirely of brass, excepting the core A, which is of ebonite; on the two sides are two brass plates CC'. Against these press two elastic brass springs, joined to two binding screws,  $a$  and  $c$ , with which are also connected the electrodes of the battery. The current arriving at  $a$  ascends in C, thence by a screw  $y$  it attains the binding screw  $b$  and the bobbin; then returning by the plate K, which is connected with the hammer, the current goes to C' by the screw  $x$ , descends to  $c$ , and rejoins the battery by the wire N. If by means of the milled head the key is turned 180 degrees, it is easy to see that exactly the opposite takes place; the current reaches the hammer by the plate K and emerges at  $b$ . Finally, if it is only turned through 90 degrees, the elastic plates rest on the ebonite A instead of on the plates CC', and the current is broken.

The two wires from the bobbin at  $o$  and  $o'$  (fig. 757) are the two ends of

the secondary wire. They are connected with the thicker wires PP', so that the current can be sent in any desired direction. With large coils the hammer cannot be used, for the surfaces become so much heated as to melt. But M. Foucault invented a mercury contact-breaker which is free from this inconvenience, and which is an important improvement.

889. **Effects produced by Ruhmkorff's coil.**—The high degree of potential which the electricity of induction coil machines possesses has long been known, and many luminous and heating effects have been obtained by their means. But it is only since the improvements which Ruhmkorff has introduced into his coil, that it has been possible to utilise all the potential of induced currents, and to show that these currents possess the properties of statical as well as dynamical electricity.

Induced currents are produced in the coil at each opening and breaking of contact. But these currents are not equal either in duration or in potential. The direct current, or that on *opening*, is of shorter duration, but higher potential; that of *closing* of longer duration but lower potential. Hence if the two ends P and P' of the fine wire (figs. 757 and 758) are connected, as there are two equal and contrary quantities of electricity in the wire the two currents neutralise each other. If a galvanometer is placed in the circuit, only a very feeble deflection is produced in the direction of the direct current. This is not the case if the two ends P and P' of the wire are separated. As the resistance of the air is then opposed to the passage of the currents, that which has highest potential, that is, the direct one, passes in excess, and the more so the greater the distance of P and P' up to a certain limit at which neither pass. There are then at P and P' nothing but potentials which are alternately contrary.

The effects of the coil, like those of the battery, may be classed under the heads *physiological*, *chemical*, *calorific*, *luminous*, *mechanical*; with this difference, that they are enormously more intense.

The *physiological* effects of Ruhmkorff's coil are very powerful; in fact, shocks are so violent that many experimenters have been suddenly prostrated by them. A rabbit may be killed with two of Bunsen's elements, and a somewhat larger number of couples would kill a man.

The *calorific* effects are also easily observed; it is simply necessary to interpose a very fine iron wire between the two ends P and P' of the induced wire; this iron wire is immediately melted, and burns with a bright light. A curious phenomenon may here be observed, namely, that when each of the wires P and P' terminates in a very fine iron wire, and these two are brought near each other, the wire corresponding to the negative pole alone melts, indicating that the tension is greater at the negative than at the positive pole.

The *chemical* effects are very varied, inasmuch as the apparatus produces electricity both in quantity and of a high potential. Thus, according to the shape and distance of the platinum electrodes immersed in water, and to the degree of acidulation of the water, either luminous effects may be produced in water without decomposition, or the water may be decomposed and the mixed gases disengaged at the two poles, or the decomposition may take place, and the mixed gases separate either at a single pole or at both poles.

Gases may also be decomposed or combined by the continued action of

the spark from the coil. Becquerel and Frémy have found that if the current of a Ruhmkorff's coil be passed through a hermetically sealed tube containing air, as shown in fig. 761, nitrogen and oxygen combine to form nitrous acid.

The *luminous* effects of Ruhmkorff's coil are also very remarkable, and vary according as they take place in air, in vapour, or in very rarefied vapours.

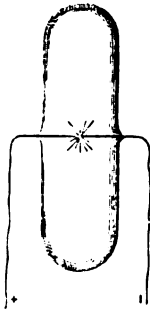

Fig. 761.

In air the coil produces a very bright loud spark, which, with the largest-sized coils, has a length of 36 inches. In vacuo the effects are also remarkable. The experiment is made by connecting the two wires of the coil P and P' with the two rods of the electrical egg (fig. 614) used for producing in vacuo the luminous effects of the electrical machine. A vacuum having been produced up to 1 or 2 millimetres, a beautiful luminous trail is produced from one knob to the other, which is virtually constant, and has the same intensity as that obtained with a powerful electrical machine when the plate is rapidly turned. This experiment is shown in figs. 766 and 767. Fig. 765 represents a remarkable deviation which light undergoes when the hand is presented to the egg.

The positive pole of the current shows the greatest brilliancy; its light is of a fiery red, while that of the negative pole is of a feeble violet colour; moreover, the latter extends along all the length of the negative rod, which is not the case with the positive pole.

The coil also produces mechanical effects so powerful that with the largest apparatus glass plates two inches thick have been perforated. This result, however, is not obtained by a single charge, but by several successive charges.

The experiment is arranged as shown in fig. 762. The two poles of the induced current correspond to the binding screws *a* and *b*; by means of a

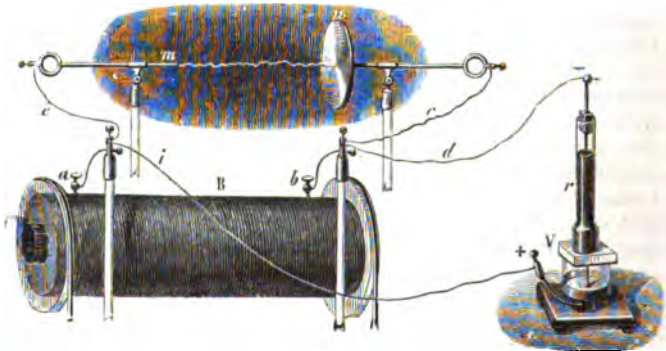

Fig. 762.

copper wire, the pole *a* is connected with the lower part of an apparatus for piercing glass like that already described (fig. 619), the other pole is attached to the other conductor by a wire *d*. The latter is insulated in a large glass tube *r*, filled with shellac, which is run in while in a state of fusion.

Between the two conductors is the glass to be perforated, V. When this presents too great a resistance, there is danger lest the spark pass in the coil itself, perforating the insulating layers which separate the wires, and then the coil is destroyed. To avoid this, two wires, *e* and *i*, connect the poles of the coil with two metallic rods whose distance from each other can be regulated. If then the spark cannot penetrate through the glass, it bursts across, and the coil is not injured.

The coil can also be used to charge Leyden jars. With a large coil giving sparks of 6 to 8 inches, and using 6 Bunsen's elements with a large surface, Ruhmkorff charged large batteries of 6 jars each, having about 3 square yards of coated surface.

The experiment with a single Leyden jar (fig. 763) is made as follows.

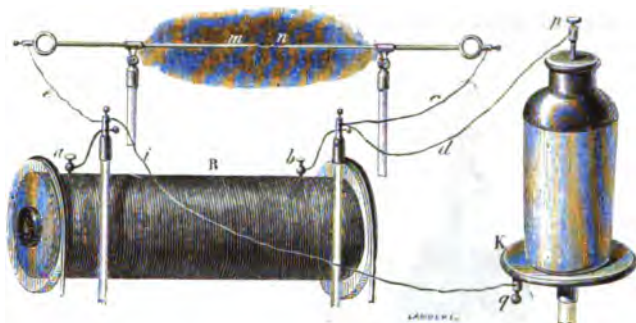

Fig. 763.

The coatings of the latter are in connection with the poles of the coil by the wires *d* and *i*, and these same poles are also connected, by means of

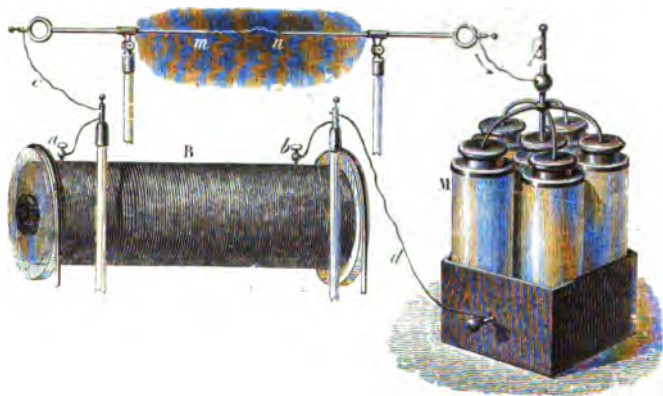

Fig. 764.

the wires *e* and *c*, with the two horizontal rods of a universal discharger (fig. 608). The jar is then being constantly charged by the wires *i* and *d*,



sometimes in one direction and sometimes in another, and as constantly discharged by the wires  $e$  and  $c$ ; the discharge from  $m$  to  $n$  taking place as a spark two or three inches in length, very luminous, and producing a deafening sound; they can scarcely be compared with the sparks of the electrical machine, but are rather true lightning discharges.

To charge a battery the form of the experiment is somewhat varied; the outer coating being connected with one pole of the coil by the wire  $d$ , and the inner coating with the other by the rods  $m$ ,  $n$ , and the wire  $c$  (fig. 720). The rods  $m$  and  $n$  are not, however, in contact. If they were, as the two currents, the inverse and direct, pass equally, the battery would not be constantly charged and discharged; while from the distance between  $m$  and  $n$  the direct current, that of opening, which has higher potential, passes alone, and it is this which charges the battery.

890. **Stratification of the electric light.**—Quet has observed, in studying the electric light which Ruhmkorff's coil gives in a vacuum, that if some of



Fig. 765.

Fig. 766.

Fig. 767.

the vapour of turpentine, wood spirit, alcohol, or bisulphide of carbon, etc., be introduced into the vessel before exhaustion, the aspect of the light is totally modified. It appears then like a series of alternately bright and dark zones, forming a pile of electric light between the two poles (fig. 766).

In this experiment it follows from the discontinuity of the current of induction, that the light is not continuous, but consists of a series of discharges which are nearer each other in proportion as the hammer  $o$  (fig. 758)

oscillates more rapidly. The zones appear to possess a rapid gyratory and undulatory motion. Quet considers this as an optical illusion; for if the hammer is slowly moved by the hand, the zones appear very distinct and fixed.

The light of the positive pole is most frequently red, and that of the negative pole violet. The tint varies, however, with the vapour or gas in the globe.

Despretz has observed that the phenomena obtained by Ruhmkorff and by Quet, with a discontinuous current, are also reproduced with an ordinary continuous current, with this important difference, that the continuous current requires a considerable number of couples, while the discontinuous current of the coil only requires a single element. It is remarkable that the luminous effects of this coil are very little increased by an increase in the number of elements.

891. **Geissler's tubes.**—The brilliancy and beauty of the stratification of the electric light are most remarkable when the discharge of the Ruhmkorff coil takes place in glass tubes containing a highly rarefied vapour or gas. These phenomena, which have been investigated, are produced by means of sealed glass tubes first constructed by Geissler, of Bonn, and generally known as *Geissler's tubes*. The tubes are filled with different gases or vapours, and are then exhausted, so that the pressure does not exceed half a millimetre. At the ends of the tubes two platinum wires are soldered into the glass.

When the two platinum wires are connected with the ends of a Ruhmkorff's coil, magnificent lustrous striæ, separated by dark bands, are produced all through the tube. These striæ vary in shape, colour, and lustre with the degree of the vacuum, the nature of the gas or vapour, and the dimensions of the tube. The phenomenon has occasionally a still more brilliant aspect from the fluorescence which the electric discharge excites in the glass.



Fig. 768.

Fig. 768 represents the striæ given by hydrogen under half a millimetre of pressure; in the bulbs the light is white, in the capillary parts it is red.

Fig. 769 shows the striæ in carbonic acid under a quarter of a millimetre pressure; the colour is greenish, and the striæ have not the same form as hydrogen. In nitrogen the light is orange yellow.

Plücker has found that the light in a Geissler's tube does not depend on the substance of the electrodes, but simply on the nature of the gas or vapour in the tube. He has found that the lights furnished by hydrogen, nitrogen, carbonic oxide, etc., give different spectra when they are decomposed by a prism. The discharge of the coil which passes through a highly rarefied

gas would not pass through a perfect vacuum, from which it follows that the presence of a ponderable substance is absolutely necessary for the passage of electricity.

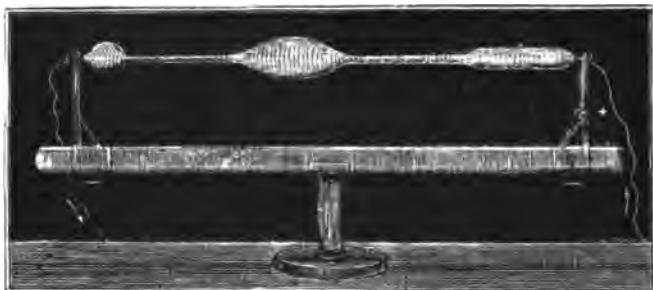

Fig. 769.

By the aid of a powerful magnet Plücker tried the action of magnetism on the electric discharge in a Geissler's tube, as Davy had done with the ordinary voltaic arc, and obtained many curious results, one of which may be mentioned. He found that where the discharge is perpendicular to the line of the poles, it is separated into two distinct parts, which can be referred to the different action exerted by the electromagnet on the two extra currents produced in the discharge.



Fig. 770.

The light of Geissler's tubes has been applied to medical purposes. A long capillary tube is soldered to two bulbs provided with platinum wires; this tube is bent in the middle, so that the two branches touch, and their extremities are twisted, as shown at *a* in fig. 770. This tube contains a highly rarefied gas, like those previously described, and, when the discharge passes, a light is produced at *a*, bright enough to illuminate any cavity of the

body into which the tube is introduced.

**892. Rotation of induced currents by magnets.**—De la Rive has recently devised an experiment which shows in a most ingenious manner that magnets act on the light in Geissler's tubes in accordance with the laws with which they act on any other movable conductor.

This apparatus consists of a glass globe or electrical egg (fig. 771), provided at one end with two stopcocks, one of which can be screwed on the air pump, and the other, which is a stopcock like that of Gay Lussac (371), serves to introduce a few drops of the liquid into the globe. At the other end a tubulure is cemented, through which passes a rod of soft iron about  $\frac{1}{8}$  of an inch in diameter, the top of which is about the centre of the globe. Except at the two ends, this bar is entirely covered with a very thick insulating layer of shellac, then with a glass tube also coated with shellac, and finally with another glass tube uniformly coated with a layer of wax. This insulating layer must be at least  $\frac{3}{8}$  of an inch thick. Inside the globe the insulating

layer is surrounded at  $x$  with a copper ring connected by means of a copper wire with a binding screw,  $c$ .

The vessel having been exhausted as completely as possible, a few drops of ether or of turpentine are introduced by means of the stopcock  $a$ ; it is again exhausted, so that the vapour remaining is highly rarefied.

A thick disc of soft iron,  $o$ , provided with a binding screw, is then placed on one of the branches of a powerful electromagnet, and the end  $m$  of the rod  $mn$  is placed on this disc, while at the same time one of the ends of the secondary wire of Ruhmkorff's coil is connected with the binding screw  $c$ , and the other with the knob  $b$ . If then the coil is worked without setting in

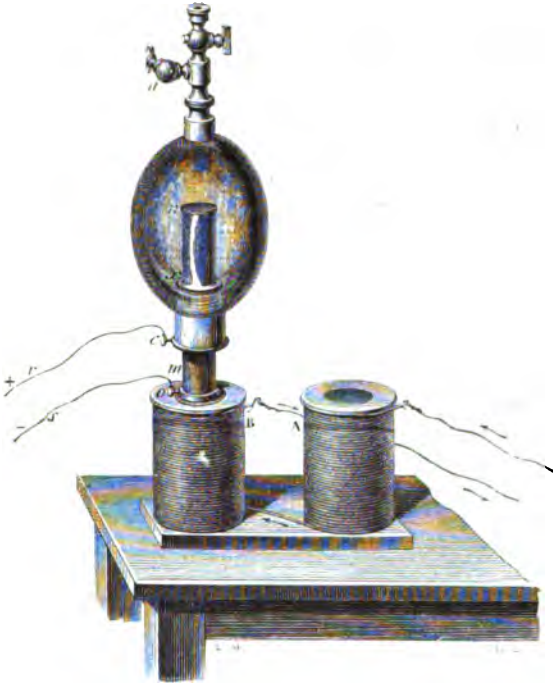

Fig. 771.

action the electromagnet, the electricity of the wire  $s$  passes to the top  $n$  of the soft iron rod, and that of the second wire to the ring  $x$ , and a more or less irregular luminous sheaf appears on the inside of the globe round the rod, as in the experiment of the electric egg.

But if a voltaic current passes into the electromagnet, the phenomenon is different; instead of starting from different points of the upper surface  $n$ , and the ring  $x$ , the light is condensed and emits a single luminous arc from  $n$  to  $x$ . Further, and this is the most remarkable part of the experiment, this arc turns slowly round the magnetised cylinder  $mn$ , sometimes in one

direction, and sometimes in another, according to the direction of the induced current, or the direction of the magnetism. As soon as the magnetism ceases the luminous phenomenon reverts to its original appearance.

This experiment is remarkable as having been devised *à priori* by De la Rive to explain, by the influence of terrestrial magnetism, a kind of rotatory motion from east to west, observed in the aurora borealis. The rotation of the luminous arc in the above experiment can evidently be referred to the rotation of currents by magnets.

Geissler has constructed a very useful form of the above experiment, in which the globe is exhausted once for all. Apart from the purpose for which it was originally devised it is a very convenient arrangement for demonstrating the action of magnets on movable currents.

**893. Heat developed by the induction of powerful magnets on bodies in motion.**—We have already seen in Arago's experiments (873) that a rotating copper disc acts at a distance on a magnetic needle, communicating to it a rotatory motion. We shall presently see that a cube of copper, rotating with great velocity, is suddenly stopped by the influence of the poles of two strong magnets (895). It is clear that in order to prevent the rotation of the needle or of the copper, a certain mechanical force must be consumed in overcoming the resistance which arises from the inductive action of the magnet. Reasoning upon the theory of the transformation of mechanical work

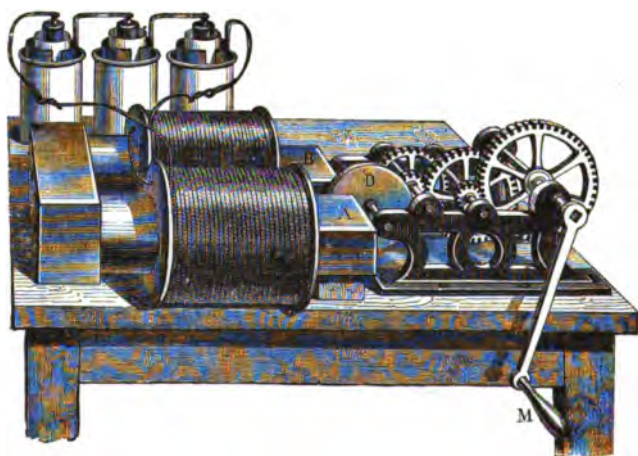

Fig. 772.

into heat, (483), it has been attempted to ascertain what quantity of heat is developed by the action of induced currents under the influence of powerful magnets. Joule, with a view of determining the mechanical equivalent of heat, coiled a quantity of copper wire round a cylinder of soft iron, and having enclosed the whole in a glass tube full of water he imparted to the system a rapid rotation between the branches of an electromagnet. A thermometer placed in the liquid served to measure the

quantity of heat produced by the induced currents in the soft iron and the wire round it. It was thus found that the heat developed was proportional to the square of the magnetism evoked, and was equivalent to the work used in the rotation.

Foucault has made a remarkable experiment by means of the apparatus represented in fig. 772. It consists of a powerful electromagnet fixed horizontally on a table. Two pieces of soft iron, A and B, are in contact with the poles of the magnet, and becoming magnetised by induction, they concentrate their magnetic inductive action on the two faces of a metallic disc, D; this disc, which is of copper, is 3 inches in diameter, and a quarter of an inch thick, partly projects between the pieces A and B, and can be moved by means of a handle and a series of toothed wheels with a velocity of 150 to 200 turns in a second.

So long as the current does not pass through the wire of the electro-magnet, very little resistance is experienced in turning the handle, and when once it has begun to rotate rapidly, and is left to itself, the rotation continues in virtue of the acquired velocity. But if the current passes, the disc and other pieces stop almost instantaneously; and if the handle is turned considerable resistance is felt. If, in spite of this, the rotation be continued, the force used is transformed into heat, and the disc becomes heated to a remarkable extent. In an experiment made by M. Foucault the temperature of the disc rose from  $10^{\circ}$  to  $61^{\circ}$ , the current being formed by three of Bunsen's elements; with six the resistance was such that the rotation could not long be continued.

## CHAPTER VII.

### OPTICAL EFFECTS OF POWERFUL MAGNETS. DIAMAGNETISM.

894. **Optical effects of powerful magnets.**—Faraday observed in 1845, that a powerful electromagnet exercises an action on many substances, such that if a polarised ray traverses them in the direction of the line of the magnetic poles, the plane of polarisation is deviated either to the right or to the left, according to the direction of the magnetisation.

Figure 773 represents Faraday's apparatus, as constructed by Ruhmkorff. It consists of two very powerful electromagnets, M and N, fixed on two iron supports, OO', which can be moved on a support, K. The current from a battery of 10 or 11 Bunsen's elements passes by the wire A to the commutator H, the bobbin M, and then to the bobbin N, by the wire g, descends in the wire z, passes again to the commutator, and emerges at B. The two cylinders of soft iron, which are in the axis of the bobbins, are perforated by cylindrical holes, to allow the luminous rays to pass. At b and a there are two Nicol's prisms, the first serving as polariser and the second as analyser. By means of a limb this latter is turned round the centre of a graduated circle, P.

The two prisms being then placed so that their principal sections are perpendicular to each other, the prism a completely extinguishes the light transmitted through the prism b. If at c, on the axis of the two coils, a plate

be placed with parallel faces, either of ordinary or flint glass, light is still extinguished so long as the current does not pass ; but when the communications are established, the light reappears. It is now coloured, and if the analyser be turned from left or right, according to the direction of the current, the light passes through the different tints of the spectrum, as is the case with

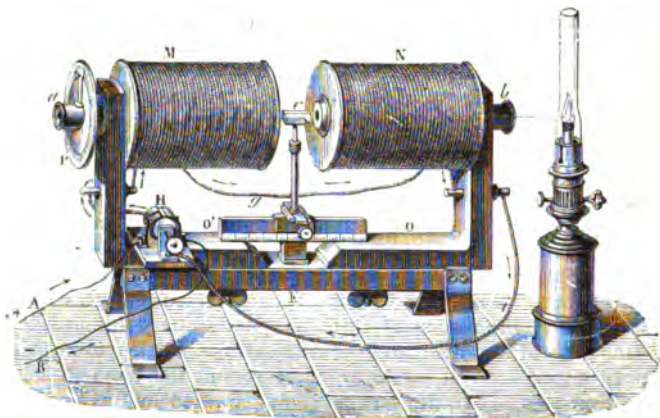

Fig. 773.

plates of quartz cut perpendicularly to the axis (657). Becquerel has shown that a large number of substances can also rotate the plane of polarisation under the influence of powerful magnets. Faraday assumes that in these experiments the rotation of the plane of polarisation is due to an action of the magnets on the luminous rays, while Biot and Becquerel ascribe the phenomena to a molecular action of the magnet on the transparent bodies submitted to its influence.

895. **Diamagnetism.**—Coulomb observed, in 1802, that magnets act upon all bodies in a more or less marked degree ; this action was at first attributed to the presence of ferruginous particles. Brugmann also found that certain bodies, for instance, bars of bismuth, when suspended between the poles of a powerful magnet, do not set *axially* between the poles, that is, in the line joining the poles, but *equatorially*, or at right angles to that line. This phenomenon was explained by the assumption that the bodies were transversely magnetic. Faraday made the important discovery in 1845 that all solids and liquids are either attracted or repelled by a powerful electro-magnet. The bodies which are attracted are called magnetic or *paramagnetic* substances, and those which are repelled are *diamagnetic* bodies. Among the metals, iron, nickel, cobalt, manganese, platinum, cerium, osmium, and palladium are magnetic ; while bismuth, antimony, zinc, tin, mercury, lead, silver, copper, gold, and arsenic are diamagnetic, bismuth being the most so and arsenic the least. The diamagnetic effects can only be produced by means of very powerful magnets, and it is by means of Faraday's apparatus that they have been discovered and studied. In experimenting on the dia-

magnetic effects—solids, liquids, and gases—armatures of soft iron, S and Q, (figs. 774-776) of different shapes are screwed on the magnets.

i. *Diamagnetism of solids.* If a small cube of copper suspended by a fine silk thread between the poles of the magnet (fig. 775), be in rapid rotation between the poles of an electromagnet, it stops the moment the current passes through the bobbins. If the movable piece have the form of a small

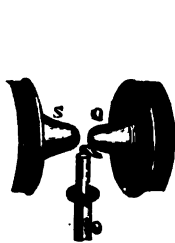

Fig. 774.

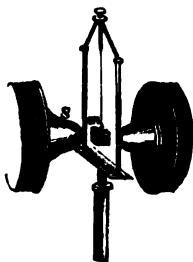

Fig. 775.

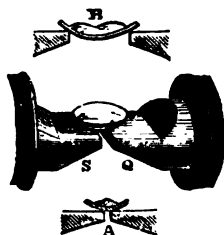

Fig. 776.

rectangular bar it sets *equatorially*, or at right angles to the axis of the bobbins, if it is a diamagnetic substance, such as bismuth, antimony, or copper; but *axially*, or in the direction of the axis, if it is a magnetic substance, such as iron, nickel, or cobalt.

Besides the substances enumerated above, the following are diamagnetic : rock crystal, alum, glass, phosphorus, iodine, sulphur, sugar, bread ; and the following are magnetic : many kinds of paper and sealing-wax, fluorspar, graphite, charcoal, etc.

ii. *Diamagnetism of liquids.* Liquids also present the phenomena of magnetism and diamagnetism. In making the experiment very thin glass tubes filled with the substance are suspended between the poles instead of the cube *m* in the figure 775. If the liquids are magnetic, such as solutions of iron or cobalt, the tubes set axially ; if diamagnetic, like water, blood, milk, alcohol, ether, oil of turpentine, and most saline solutions, the tubes set equatorially.

Very remarkable changes take place in the direction of magnetic and diamagnetic substances when they are suspended in liquids. A magnetic substance is indifferent in an equally strong magnetic liquid ; it sets equatorially in a stronger magnetic substance, and axially in a substance which is less strongly magnetic ; it sets axially in all diamagnetic liquids.

A diamagnetic substance surrounded by a magnetic or diamagnetic substance sets equatorially. According to its composition, glass is sometimes magnetic and sometimes diamagnetic, and as in these investigations glass tubes are used for containing the liquids, its deportment must first be determined, and then taken into account in the experiment.

The action of powerful magnets on liquids may also be observed in the following experiment devised by Plücker. A solution of a magnetic liquid is placed on a watch glass between the two poles, S and Q, of a powerful electromagnet. When the current passes, the solution forms the enlargement represented in fig. 776 ; this continues as long as the current passes,



and is produced to different extents with all magnetic liquids. The changes in the aspects of the liquids are, however, so small as to require careful scrutiny to detect their existence. A method of magnifying these changes so as to render them visible to large audiences, has been devised by Prof. Barrett. A source of light is placed above the watch glass containing a drop of the solution to be tried. Below the watch glass, and between the legs of the magnet, is placed a mirror at the angle of  $45^\circ$ . By this means the beam of light passing through the watch glass is reflected at right angles on to a screen, where an image of the drop is focussed by a lens. If now a drop of diamagnetic liquid, such as water, or better sulphuric acid, be placed on the watch glass, as soon as the current passes, the flattened drop retreats from the two poles, and gathers itself up into a little heap, as at A (fig. 776). So doing it forms a double convex lens, by which the light is brought to a short focus below the drop, an effect instantly seen on the screen. When the current is interrupted the drop falls, and the light returns to its former appearance. A magnetic liquid, such as a solution of perchloride of iron, has exactly the opposite effect. The drop attracted to the two poles becomes flattened, and instead of a plano-convex shape, at which it rests, it becomes nearly concavo-convex as at B. The light is dispersed, and the effect manifest on the screen. Instead of a mirror and lens, a sheet of white paper may be placed in an inclined position under the watch glass, and the effects are somewhat varied, but equally well pronounced.

iii. *Diamagnetism of gases.* Bancalari observed that the flame of a candle placed between the two poles in Faraday's apparatus was strongly repelled (fig. 774). All flames present the same phenomenon to different extents, resinous flames or smoke being most powerfully affected.

The magnetic deportment of gases may be exhibited for lecture purposes by inflating soap bubbles with them between the poles of the electromagnet, and projecting on them either the lime or the electric light.

Faraday experimented on the magnetic or diamagnetic nature of gases. He allowed gas mixed with a small quantity of a visible gas or vapour, so as to render it perceptible, to ascend between the two poles of a magnet, and observed their deflections from the vertical line in the axial or equatorial direction; in this way he found that oxygen was least, and nitrogen more, and hydrogen most diamagnetic. With iodine vapour, produced by placing a little iodine on a hot plate between the two poles, the repulsion is strongly marked. Becquerel found that oxygen is the most strongly magnetic of all gases, and that a cubic yard of this gas condensed would act on a magnetic needle like 5.5 grains of iron. Faraday has found that oxygen, although magnetic under ordinary circumstances, becomes diamagnetic when the temperature is much raised, and that the magnetism or diamagnetism of a substance depends on the medium in which it is placed. A substance, for instance, which is magnetic in vacuo, may become diamagnetic in air.

In the crystallised bodies which do not belong to the regular system, the directions in which the magnetism or diamagnetism of a body is most easily excited, are generally related to the crystallographic axis of the substance. The optic axis of the uniaxial crystals sets either axially or equatorially when a crystal is suspended between the poles of an electromagnet. Faraday has ascertained from this the existence of a *magneto-crystalline* force, but it appears

probable from Knoblauch's researches, that the action arises from an unequal density in different directions, inasmuch as unequal pressure in different directions produces the same result.

The repulsion produced in a diamagnetic body under the influence of a powerful magnet is due to the fact that the magnet develops in the end nearest to it like polarity, and in the end furthest away unlike polarity; a phenomenon the exact opposite of that of iron. A bar of bismuth placed in a spiral becomes magnetised, but with a polarity just the reverse of that of an iron rod under the same circumstances.

According to Plücker, for a given unit of magnetising force, the specific magnetisms developed in equal weights of the undermentioned substances are represented by the following numbers, those bodies with the minus signs prefixed being diamagnetic :—

Iron . . . . .	1,000,000	Nickel oxide . . . . .	287
Cobalt . . . . .	1,009,000	Water . . . . .	-25
Nickel . . . . .	465,800	Bismuth . . . . .	-23'6
Iron oxide . . . . .	759	Phosphorus . . . . .	-13'1

iv. *Detonation produced by the rupture of a current under the influence of a powerful electromagnet.* The following experiment devised by Ruhmkorff is a remarkable effect of Faraday's apparatus. When the two ends of a stout wire in which the current of the electromagnet passes are placed between the two poles, S and Q, of figure 774, that is to say, when the current is closed between S and Q, this closing takes place without a spark and without noise, or merely a feeble noise and a spark. But when the two ends are separated, and the current is hence broken, a violent noise is heard almost as strong as the report of a pistol. It would appear to be the extra current, the intensity of which is greatly increased by the influence of two poles.

## CHAPTER VIII.

### THERMO-ELECTRIC CURRENT.

[896. **Thermo-electricity.**—In 1821, Professor Seebeck, in Berlin, found that by heating one of the junctions of a metallic circuit, consisting of two metals soldered together, an electric current was produced.] This phenomenon may be shown by means of the apparatus represented in fig. 777, which consists of a plate of copper, *mn*, the ends of which are bent and soldered to a plate of bismuth, *op*. In the interior of the circuit is a magnetic needle moving on a pivot. When the apparatus is placed in the magnetic meridian, and one of the solderings gently heated, as shown in the figure, the needle is deflected in a manner which indicates the passage of a current from *n* to *m*, that is, from the heated to the cool junction in the copper. [If, instead of heating the junction *n*, it is cooled by ice, or by placing upon it cotton wool moistened with ether, the other junction remaining at the ordinary temperature, a current is produced, but in the opposite direction; that is to say, from *m* to *n*. In both cases the current is more energetic in proportion as the *difference* in temperature of the solderings is greater.

Seebeck gave the name *thermo-electric* to this current, and to the couple which produces it, to distinguish it from the *hydro-electric* or ordinary voltaic current and couple.



Fig. 777.

897. **Thermo-electric series.**—If small bars of two different metals are soldered together at one end while the free ends are connected with the wires of a galvanometer, and if now the point of junction of the two metals be heated, a current is produced, the direction of which is indicated by the deflection of the needle of the galvanometer. Moreover, the strength of the current calculated from the deflection of the galvanometer is proportional to the electromotive force of the *thermo-element*. By experimenting in this way with different metals, they may be formed in a list such that each metal gives rise to positive electricity when associated with one of the following, and negative electricity with one of those that precede:—that is, that in heating the soldering, the positive current goes from the positive to the negative metal across the soldering, just as if the soldering represented the liquid in a hydro-electrical element; hence out of the element, in the connecting wire in the galvanometer for instance, the current goes from the negative to the positive metal.

Thus a couple, bismuth-antimony, heated at the junction would correspond to a couple, zinc-copper, immersed in sulphuric acid. The following is a list drawn up from Matthiessen's researches, which also gives comparative numerical values for the electromotive force:—

Bismuth . . . . .	+ 25	Gas coke . . . . .	- 0·1
Cobalt . . . . .	9	Zinc . . . . .	0·2
Potassium . . . . .	5·5	Cadmium . . . . .	0·3
Nickel . . . . .	5	Strontium . . . . .	2·0
Sodium . . . . .	3	Arsenic . . . . .	3·8
Lead . . . . .	1·03	Iron . . . . .	5·2
Tin . . . . .	1	Red phosphorus . . . . .	9·6
Copper . . . . .	1	Antimony . . . . .	9·8
Platinum . . . . .	0·7	Tellurium . . . . .	179·9
Silver . . . . .	1·0	Selenium . . . . .	- 290·0

The meaning of the numbers in this list is that, taking the electromotive force of the copper-silver couple as unity, the electromotive force of any pair

of metals is expressed by the difference of the numbers where the signs are the same and by the sum where the signs are different. Thus the electromotive force of a bismuth-nickel couple would be  $25 - 5 = 20$ ; of a cobalt-iron  $9 - (-5.2) = 14.2$ , and of an iron-antimony  $-5.2 - 9.8 = -4.6$ . Where the positive sign is fixed, the current is from the other metal to silver across the soldering; and where the negative, from silver to that metal.

Hence, of these bodies, bismuth and selenium produce the greatest electromotive force; but from the expense of this latter element, and on account of its low conducting power, antimony is generally substituted. The antimony is the negative metal but the positive pole, and the bismuth the positive metal but the negative pole, and the current goes from bismuth to antimony across the junction.

If copper wires connected with the ends of a galvanometer are soldered together to the ends of an antimony rod, and if one of the junctions is heated to  $50^\circ$ , the other being obtained at  $0^\circ$ , a certain deflection is observed in the galvanometer. If similarly a compound bar, consisting of antimony and tin soldered together, be connected with the ends of the galvanometer, and if the junction copper-tin, and the junction tin-antimony, be heated to  $50^\circ$ , while the junction antimony-copper is kept at  $0^\circ$ , the deflection is the same as in the previous case. Hence the electromotive force produced by heating the two junctions, copper-tin and tin-antimony, is equal to the electromotive force produced by heating the junction copper-antimony.

Becquerel found with a number of couples, where one end of the junction was heated to a given temperature and the other kept at  $0^\circ$ , that the intensity of the current was proportional to the temperature at the heated junction. If the two junctions are at any given temperatures, the intensity of the current is proportional to the difference of the temperature of the two places, provided that this does not exceed  $50^\circ$ .

The direction of the current frequently changes when the temperature of the couple is raised beyond a certain limit. Thus, in a copper and iron circuit, the current goes from copper to iron through the heated part, provided the temperature does not exceed  $300^\circ$ ; at a higher temperature the current changes its direction, and goes from iron to copper.

As compared with ordinary hydro-electric currents the electromotive force of thermo-currents is very small; thus the electromotive force of a bismuth-copper element with a difference of  $100^\circ$  C. in the temperatures of their junctions is according to Wheatstone  $\frac{1}{95}$ , and according to Neumann  $\frac{1}{236}$  that of Daniell's element: the electromotive force of an iron-argentan couple with  $10^\circ$  to  $15^\circ$  difference of temperatures at their junctions is  $\frac{1}{8800}$  that of a Daniell's, according to Kohlrausch.

898. **Causes of thermo-electric currents.**—The thermo-electric currents cannot be attributed to contact, for they can be produced in circuits formed of a single metal. Nor do they arise from chemical actions, for Becquerel has found that they are formed in hydrogen, and even in vacuo. The same physicist ascribes them to the unequal propagation of heat in the different parts of the circuit. He found that when all the parts of a circuit are homogeneous, no current is produced on heating, because the heat is equally propagated in all directions. This is the case if the wires of the galvanometer are connected by a second copper wire. But if the uniformity of this

is destroyed by coiling it in a spiral, or by knotting it, the needle indicates by its deflection a current going from the heated part to that in which the homogeneity has been destroyed. If the ends of the galvanometer wires be coiled in a spiral, and one end is heated and touched with the other, the current goes from the heated to the cooled end.

When two plates of the same metal, but at different temperatures, are placed in a fused salt such as borax, which conducts electricity but exerts no chemical action, a current passes from the hotter metal through the fused salt to the colder one. Hot and cold water in contact produce a current which goes from the warm water to the cold.

Svanberg has found that the thermo-electromotive force is influenced by the crystallisation; for instance, if the cleavage of bismuth is parallel to the face of contact, it is greater than if both are at right angles, and that the reverse is the case with antimony. Thermo-electric elements may be constructed of either two pieces of bismuth or two pieces of antimony, if in the one the principal cleavage is parallel to the place of contact, and in the other is at right angles. Hence the position of metals in thermo-electric series is influenced by their crystalline structure.

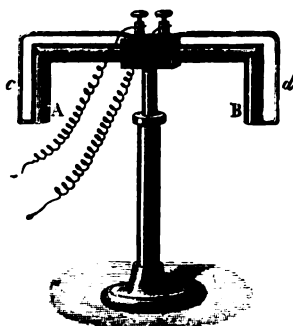

Fig. 778.

778 represents a bismuth-copper couple; fig. 779 represents a series of couples used by Pouillet. The former consists of a bar of bismuth bent twice at

899. **Thermo-electric couples.**—From what has been said it will be understood that a thermo-electric couple consists of two metals soldered together, the two ends of which can be joined by a conductor. Fig.

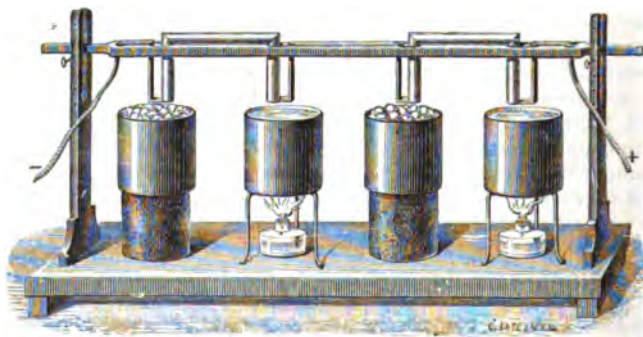

Fig. 779.

right angles, at the ends of which are soldered two copper strips, *c*, *d*, which terminate in two binding screws fixed on some insulating material.

When several of these couples are joined so that the second copper of

the first is soldered to the bismuth of the second, then the second copper of this to the bismuth of the third, and so on, this arrangement constitutes a thermo-electric battery, which is worked by keeping the odd solderings, for instance, in ice, and the even ones in water, which is heated to 100°.

900. **Nobili's thermo-electric pile.**—Nobili devised a form of thermo-electric battery, or *pile* as it is usually termed, in which there are a large number of elements in a very small space. For this purpose he joined the couples of bismuth and antimony in such a manner, that after having formed a series of five couples, as represented in fig. 781, the bismuth from *b* was soldered to the antimony of a second series arranged similarly; the last bismuth of this to the antimony of a third, and so on for four vertical series, containing together 20 couples, commencing by antimony, finishing by bismuth.

Thus arranged, the couples are insulated from one another by means of small paper bands covered with varnish, and then enclosed in a copper frame, P (fig. 780), so that only the solderings appear at the two ends of the pile. Two small copper binding screws, *m* and *n*, insulated in an ivory ring, communicate in the interior, one with the first antimony, representing the positive pole, and the other with the last bismuth, representing the negative pole. These binding screws communicate with the extremities of a galvanometer wire when the thermo-electric current is to be observed.



Fig. 780.



Fig. 781.

901. **Becquerel's thermo-electric battery.**—Becquerel has found that artificial sulphuret of copper heated from 200° to 300° is powerfully positive, and that a couple of this substance and copper has an electro-motive force



Fig. 782.

nearly ten times as great as that of the bismuth and copper couple in fig. 778. Native sulphuret, on the contrary, is powerfully negative. As the artificial

sulphuret only melts at about  $1,035^{\circ}$ , it may be used at very high temperatures. The metal joined with it is German silver (90 of copper and 10 of nickel). Fig. 782 represents the arrangement of a battery of 50 couples arranged in two series of 25. Fig. 784 gives on a larger scale the view of a single couple, and fig. 783 that of 6 couples in two series of 3. The sulphuret

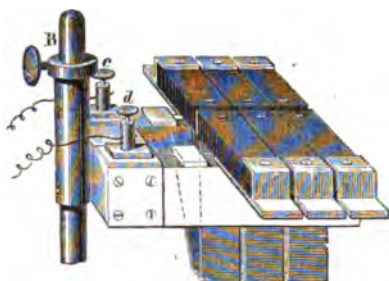

Fig. 783.

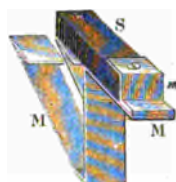

Fig. 784.

is cut in the form of rectangular prisms, 10 centimetres in length, by 18mm. in breadth, and 12mm. thick. In front is a plate of German silver *m*, intended to protect the sulphuret from roasting when it is placed in a gas flame. Below there is a plate of German silver *MM*, which is bent several times so as to be joined to the sulphuret of the next, and so on. The couples, thus arranged in two series of 25, are fixed to a wooden frame supported by two brass columns *AB*, on which it can be more or less raised. Below the couples there is a brass trough, through which water is constantly flowing, arriving by the tube *b* and emerging by the stopcock *r*. The plates of German silver are thus kept at a constant temperature. On each side of the trough are two long burners on the Argand principle fed by gas from a caoutchouc tube, *a*. The frame being sufficiently lowered, the ends are kept at a temperature of  $200^{\circ}$  to  $300^{\circ}$ . For utilising the current, two binding screws are placed on the left of the frame, one communicating with the first sulphuret, that is, the positive pole, and the other with the last German silver, or the negative pole. At the other end of the frame are two binding screws, which facilitate the arrangement of the couples in different ways.

The current of this battery may be used for telegraphing even through a great distance, and passed into an electromagnet can lift a weight of 200 pounds. It can raise a short piece of fine iron wire to redness, and freely decomposes water. The electromotive force of a Daniell's cell is equal to about 8 or 9 of these couples.

902. **Clamond's thermo-electric battery.**—Of the attempts which have been made to apply thermo-electric currents to directly practical purposes the most successful has been Clamond's, which is used both for telegraphic purposes and also for electroplating. Its characteristic features are the construction and arrangement of the elements, and the manner in which the heating is effected.

The negative element consists of an alloy of two parts of antimony and

one of zinc, forming a flat spindle-shaped bar from 2 to 3 inches in length, by  $\frac{3}{8}$  in. in thickness (fig. 786). The positive metal is a thin strip or lug of tin-plate, stamped as represented at *aa'* in fig. 785; this is then bent in as shown at *c*, and being held in a mould the alloy which melts at 260°C. is poured in. The individual elements have then the appearance represented in fig. 786, and to



Fig. 785.



Fig. 786.

connect them together the tin lugs are bent into shape, and joined in a circle of elements (fig. 787), being kept in their position by a paste of asbestos and soluble glass; flat rings of this composition are also made, and are placed between each series of rings piled over each other; the connection between the individual elements, and between the sets of rings is made by soldering together the projecting ends of the tin lugs. Thin plates of mica are placed between the alloy and the tin-plate, excepting at the place of soldering. Looked at from the inside the faces of the battery present the appearance of a perfect cylinder.

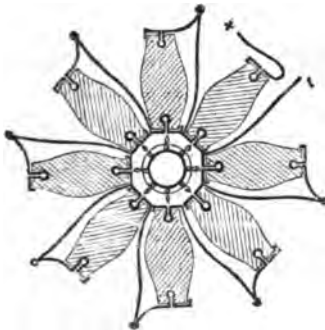

Fig. 787.

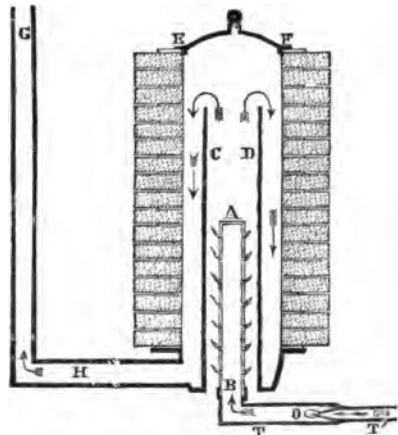

Fig. 788.

The heating is effected by means of coal gas; admitted through an earthenware tube, AB, fig. 788, perforated by numerous small holes; this is surrounded by a somewhat larger iron tube CD reaching nearly to the top of the cylinder, which is closed by a lid, E. Air enters at the bottom of this tube, and the heated gases, passing up the tube, curl over the top, descend on the



outside, and escape by a chimney GH. This arrangement economises gas and prevents danger from overheating, as the gas-jets do not impinge directly on the element. The supply of gas is regulated by an automatic arrangement, so that the temperature does not exceed about  $200^{\circ}$ .

A battery of 60 such elements has an electro-motive force of three volts, and an internal resistance of  $1\frac{1}{2}$  ohms. The amount of the gas consumed per hour for this size is three cubic feet, and such a battery costs four pounds.

903. **Melloni's thermomultiplier.**—We have already noticed the use which Melloni has made of Nobili's pile, in conjunction with the galvanometer,

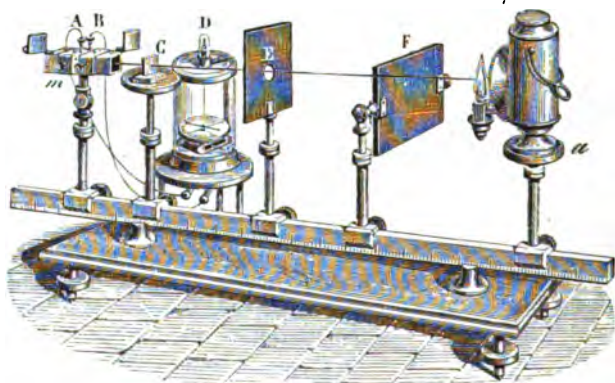

Fig. 789.

for measuring the most feeble alterations of temperature. The arrangement he used for his experiment is represented in fig. 789.

On a wooden base, provided with levelling screws, a graduated copper rule, about a metre long, is fixed edgewise. On this rule the various parts composing the apparatus are placed, and their distances can be fixed by means of binding screws. *a* is a support for a Locatelli's lamp, or other source of heat; F and E are screens; C is a support for the bodies under experiment, and *m* is a thermo-electrical battery. Near the apparatus is a galvanometer, D; this has only a comparatively few turns of a tolerable thick (1 mm.) copper wire; for the electromotive force of the thermocurrents is small, and as the internal resistance is small too, for it only consists of metal, it is clear that no great resistance can be introduced into the circuit if the current is not to be completely stopped. Such galvanometers are called *thermomultipliers*. The delicacy of this apparatus is so great that the heat of the hand is enough at a distance of a yard from the pile to deflect the needle of the galvanometer.

In using it for measuring temperature, the relation of the deflection of the needle, and therefore of the intensity of the current, to the difference of the temperatures of the two ends, must be determined. That known, the temperatures of the ends not exposed to the source of heat being known, the observed deflection gives the temperature of the other, and therewith the intensity of the source of heat.

904. **Properties and uses of thermo-electric currents.**—Thermo-electric currents are of extremely low tension, but of great constancy; for their opposite junctions, by means of melting ice and boiling water, can easily be kept at  $0^{\circ}$  and  $100^{\circ}$  C. On this account, Ohm used them in the experimental establishment of his law. They can produce all the actions of the ordinary battery in kind, though in less degree. By means of a thermo-electrical pile consisting of 769 elements of iron and German silver, the ends of which differed in temperature by about  $10^{\circ}$  to  $15^{\circ}$ , Kohlrausch proved the presence of free positive and negative electricity at the two ends of the open pile respectively. He found that the density of the free electricity was nearly proportional to the number of elements, and also that the electromotive force of a single element under the above circumstances was about  $\frac{1}{6600}$  that of a single Daniell's element. On account of their feeble tension, thermo-electric piles produce only feeble chemical actions. Botto, however, with 120 platinum and iron wires, has decomposed water.

Besides these, sparks can be obtained on breaking circuit, and magnetic and physiological effects produced as with other sources of electricity.

905. **Becquerel's electrical thermometer.**—This consists of a copper and iron wire of many yards in length, soldered at their ends, but otherwise

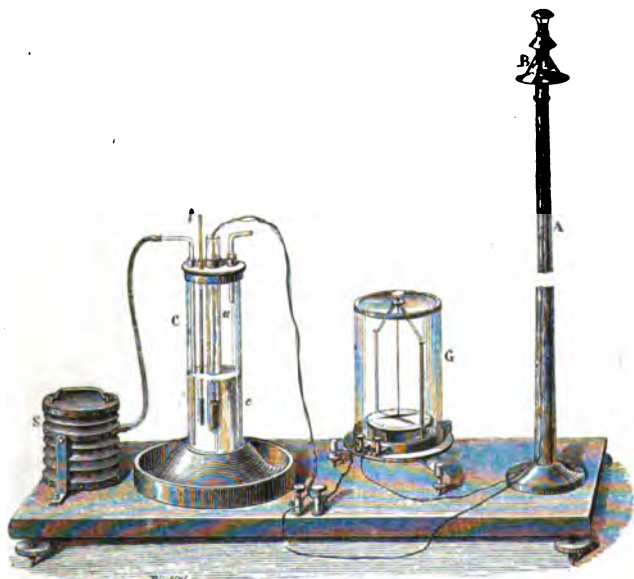

Fig. 790.

insulated from each other by being covered with gutta-percha. The copper wire is cut twice and connected with the binding screws of a galvanometer (fig. 790). One of the solderings is arranged in the place whose temperature is to be measured. In the figure it is at B at the top of a pole A, and is

underneath a hood, which protects it from rain and the sun, but allows air to circulate round it.

The other soldering is immersed in mercury contained in a glass tube, and which in turn is placed in a larger cylinder C containing ether. On one side is a very delicate thermometer *t*, which indicates the temperature of the ether. By means of a small bellows S, a caoutchouc tube and a glass tube, a current of air can be sent through the ether, which being thus vaporised is cooled. If, on the contrary, the temperature of the ether is to be raised, a tinplate vessel containing hot water is brought near the cylinder C.

These details being known, when the solderings are at the same temperature no current is produced in the circuit, and the galvanometer remains at zero; but when there is the least difference in temperature, the deflection of the galvanometer tells which of these solderings is the hottest. If it is the one which is immersed in the mercury, the bellows is worked until, the ether

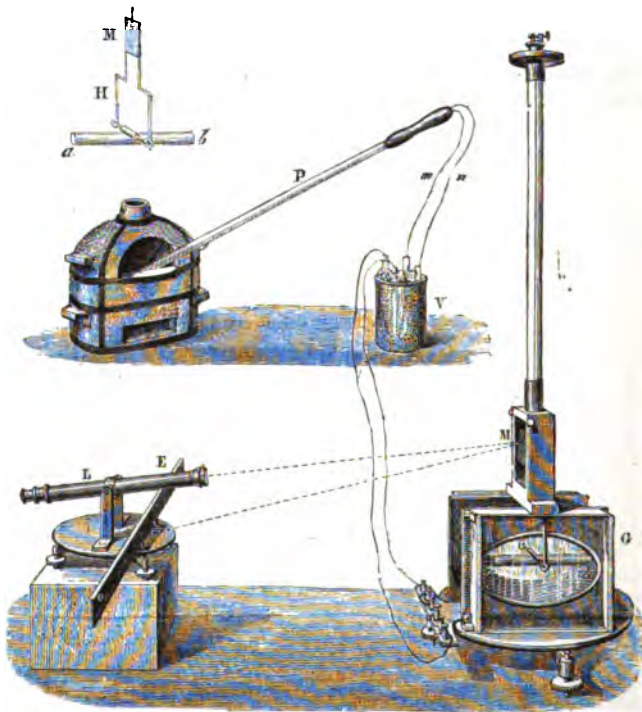

Fig. 791.

being cooled, the galvanometer reverts to zero. The two solderings being then at the same temperature the thermometer *t* at once indicates the temperature in B.

Becquerel has applied this instrument to investigations on the temperature

of the ground at various depths, that of the air at different heights, and also on the temperature of plants and animals.

906. **Bequerel's electric pyrometer.**—This apparatus is an improved form of one originally devised by Pouillet. It consists (fig. 791) of two wires, one of platinum and the other of palladium, both two metres in length and a square millimetre in section. They are not soldered at the ends, but firmly tied for a distance of a centimetre with fine platinum wire. The palladium wire is enclosed in a thin porcelain tube: the platinum wire is on the outside and the whole is enclosed in a larger porcelain tube P. At the end of this is the junction, which is adjusted in the place the temperature of which is to be investigated. At the other end project the platinum and palladium wires *m* and *n*, which are soldered to two copper wires that lead the current to a magnetometer G. These wires at the junction are placed in a glass tube immersed in ice, so that, being both at the same temperature, they give rise to no current.

The magnetometer, which was devised by Weber, is nothing more than a large galvanometer. It consists of a magnetised bar *a, b*, placed in the centre of a copper frame which deadens the oscillations (873) and rests on a stirrup, H, which in turn is suspended to a long and very fine platinum wire. On the stirrup is fixed a mirror M, which moves with the magnet; and gives by reflection the image of divisions traced on a horizontal scale E at a distance. These divisions are observed by a telescope. With this view, before the current passes, the image of the zero of the scale is made to coincide with the micrometer wire of the telescope; then the slightest deflection of the mirror gives the image of another division, and therefore the angular deflection of the bar (508). This angle is always small and should not exceed 3 or 4 degrees: this is effected by placing, if necessary, a rheostat or any resistance coil in the circuit. The angular deflection being known, the intensity of the current and the temperature of the junction are deduced from pyrometric tables. These are constructed by interpolation when the strengths are known, which correspond to two temperatures near those to be observed.

The indications of the pyrometer extend to the fusing point of the palladium.

907. **Peltier's cross.**—When on a bar of bismuth, BB', cut half-way through at its centre (fig. 792), is soldered a bar of antimony with a similar cut, and when the ends A and B are connected with a galvanometer; the needle of the galvanometer is deflected in one direction when the junction is heated and in the other when it is cooled.

Peltier found that when A' was connected with one pole, and B' with the other pole of a voltaic element, so that a current passed from A' through the junction to B', the needle was deflected in such a direction as to show that the junction was heated when the positive current passed from A' to B', while it was cooled when the current passed in the opposite direction. This experiment may be made by hermetically fixing in two tubulures in an air thermometer, a compound bar consisting of bismuth and antimony soldered together, in such a manner

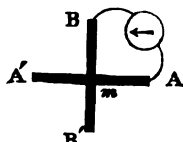

Fig. 792.

underneath a hood, which protects it from rain and the sun, but allows air to circulate round it.

The other soldering is immersed in mercury contained in a glass tube, and which in turn is placed in a larger cylinder C containing ether. On one side is a very delicate thermometer *t*, which indicates the temperature of the ether. By means of a small bellows S, a caoutchouc tube and a glass tube, a current of air can be sent through the ether, which being thus vaporised is cooled. If, on the contrary, the temperature of the ether is to be raised, a tinplate vessel containing hot water is brought near the cylinder C.

These details being known, when the solderings are at the same temperature no current is produced in the circuit, and the galvanometer remains at zero; but when there is the least difference in temperature, the deflection of the galvanometer tells which of these solderings is the hottest. If it is the one which is immersed in the mercury, the bellows is worked until, the ether

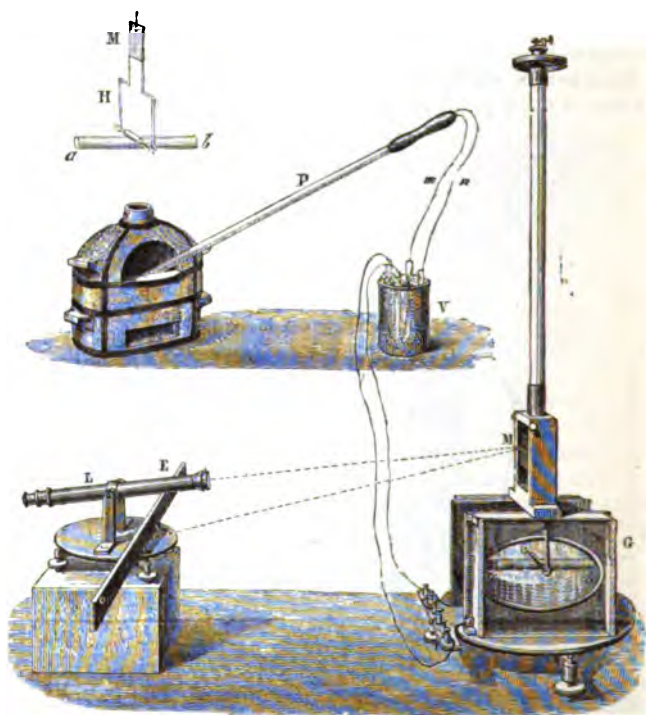

Fig. 791.

being cooled, the galvanometer reverts to zero. The two solderings being then at the same temperature the thermometer *t* at once indicates the temperature in B.

Becquerel has applied this instrument to investigations on the temperature

of the ground at various depths, that of the air at different heights, and also on the temperature of plants and animals.

906. **Bequerel's electric pyrometer.**—This apparatus is an improved form of one originally devised by Pouillet. It consists (fig. 791) of two wires, one of platinum and the other of palladium, both two metres in length and a square millimetre in section. They are not soldered at the ends, but firmly tied for a distance of a centimetre with fine platinum wire. The palladium wire is enclosed in a thin porcelain tube: the platinum wire is on the outside and the whole is enclosed in a larger porcelain tube P. At the end of this is the junction, which is adjusted in the place the temperature of which is to be investigated. At the other end project the platinum and palladium wires *m* and *n*, which are soldered to two copper wires that lead the current to a magnetometer G. These wires at the junction are placed in a glass tube immersed in ice, so that, being both at the same temperature, they give rise to no current.

The magnetometer, which was devised by Weber, is nothing more than a large galvanometer. It consists of a magnetised bar *a*, *b*, placed in the centre of a copper frame which deadens the oscillations (873) and rests on a stirrup, H, which in turn is suspended to a long and very fine platinum wire. On the stirrup is fixed a mirror M, which moves with the magnet, and gives by reflection the image of divisions traced on a horizontal scale E at a distance. These divisions are observed by a telescope. With this view, before the current passes, the image of the zero of the scale is made to coincide with the micrometer wire of the telescope; then the slightest deflection of the mirror gives the image of another division, and therefore the angular deflection of the bar (508). This angle is always small and should not exceed 3 or 4 degrees: this is effected by placing, if necessary, a rheostat or any resistance coil in the circuit. The angular deflection being known, the intensity of the current and the temperature of the junction are deduced from pyrometric tables. These are constructed by interpolation when the strengths are known, which correspond to two temperatures near those to be observed.

The indications of the pyrometer extend to the fusing point of the palladium.

907. **Peltier's cross.**—When on a bar of bismuth, BB', cut half-way through at its centre (fig. 792), is soldered a bar of antimony with a similar cut, and when the ends A and B are connected with a galvanometer; the needle of the galvanometer is deflected in one direction when the junction is heated and in the other when it is cooled.

Peltier found that when A' was connected with one pole, and B' with the other pole of a voltaic element, so that a current passed from A' through the junction to B', the needle was deflected in such a direction as to show that the junction was heated when the positive current passed from A' to B', while it was cooled when the current passed in the opposite direction. This experiment may be made by hermetically fixing in two tubulures in an air thermometer, a compound bar consisting of bismuth and antimony soldered together, in such a manner

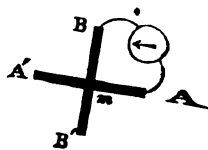

Fig. 792.

that the ends project on each side. The projecting parts are provided with binding screws, so as to allow a current to be passed through. When the positive current passes from the antimony to the bismuth, the air in the bulb is heated, it expands, and the liquid in the stem sinks; but if it passes in the opposite direction the air is cooled, it contracts, and the liquid rises in the stem. For this experiment the current must have a certain definite strength, which is found by experiment; it is best regulated by a rheostat (908).

These experiments form an interesting illustration of the principle, that whenever the effects of heat are reversed, heat is produced; and whenever the effects ordinarily produced by heat are otherwise produced, cold is the result.

## CHAPTER IX.

### DETERMINATION OF ELECTRICAL CONDUCTIVITY.

908. **Rheostat.**—The rheostat is an instrument by which the resistance of any given circuit can be increased or diminished without opening the circuit. As invented by Wheatstone, it consists of two parallel cylinders, one, A, of brass, the other, B, of wood (fig. 793). In the latter there is a spiral groove, which terminates at *a* in a copper ring, to which is fixed the end of a fine brass wire. This wire, which is about 40 yards long, is partially coiled on the groove; it passes to the cylinder A, and, after a great number of turns on this cylinder, is fixed at the extremity *c*. Two binding screws, *n* and *o*, connected with the battery, communicate by two steel plates; one with the cylinder A, the other with the ring *a*.

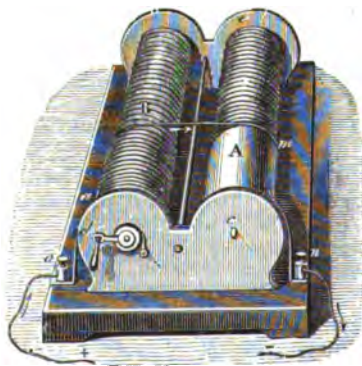

Fig. 793.

When a current enters at *o*, it simply traverses that portion of the wire rolled on the cylinder B, where the windings are insulated by the grooves; passing thence to the cylinder A, which is of metal, and in contact with the wire, the current passes directly to *m*, and thence to *n*. Hence if the length of the current is to be increased, the handle, *d*, must be turned from right to left. If, on the contrary it is to be diminished, the handle is to be fixed on the axis, *c*, and turning then from

left to right, the wire is coiled on the cylinder A. The length of the circuit is indicated in feet and inches, by two needles, at the end of the apparatus not seen in the figure, which are moved by the cylinders A and B.

909. **Determination of the resistance of a conductor. Reduced length.**—If in the circuit of a constant element a tangent compass be inter-

posed, a certain deflection of the needle will be produced. If, then, different lengths of copper wire of the same diameter be successively interposed, corresponding deflections will in each case be produced. Let us suppose that in a particular case the tangent of the angle of deflection (799) observed with the element and tangent compass alone was 1·88, and that when 5, 40, 70, and 100 yards of copper wire were successively placed in the circuit, the tangents of the corresponding deflections were 0·849, 0·172, 0·105, and 0·074. Now, in this experiment, the total resistance consists of two components; the resistance offered by the element and the tangent compass, and the resistance offered by the wire in each case. The former resistance may be supposed to be equal to the resistance of  $x$  yards of copper wire of the same diameter as that used, and then we have the following relations :

<i>Length of wire.</i>	<i>Tangent of angle of deflection.</i>
$x$ yards . . . . .	1·88
$x + 5$ " . . . . .	0·849
$x + 40$ " . . . . .	0·172
$x + 70$ " . . . . .	0·105
$x + 100$ " . . . . .	0·074

If the intensities of the currents are inversely as the resistances—that is, as the lengths of the circuits—the proportion must prevail,

$$x : x + 5 = 0·849 : 1·886 ;$$

from which  $x = 4·11$ . Combining, in like manner, the other observations, we get a series of numbers, the mean of which is 4·08. That is, the resistance offered by the element and galvanometer is equal to the resistance of 4·08 yards of such copper wire, and this is said to be the *reduced length* of the element and galvanometer in terms of the copper wire.

It is of great scientific and practical importance to have a *unit* or *standard of comparison* of resistance, and numerous such have been proposed. Jacobi proposed the resistance of a metre of a special copper wire a millimetre in diameter. Copper is, however, ill adapted for the purpose, as it is difficult to obtain pure. Matthiessen has proposed an alloy of gold and silver, containing two parts of gold and one of silver; its conducting power is very little affected by impurities in the metals, by annealing, or by moderate changes of temperature.

*Siemens' unit* is a metre of pure mercury, having a section of a square millimetre. It is 0·9536 of an Ohm or BA unit (910).

The *Varley unit*, which is used in telegraphic work, is a standard mile of a *special* copper wire  $\frac{1}{16}$  of an inch in diameter. Matthiessen has proposed instead of this a mile of pure annealed copper wire  $\frac{1}{16}$  in. in diameter.

910. **Absolute measure of electrical resistance.**—When the resistance of any conductor has been measured and expressed by reference to any of the standards of resistance mentioned in the preceding paragraph, the number denoting the result of the measurement still does not tell us what the resistance of the conductor in question really is: it only tells us what multiple it is of the resistance of the particular conductor with which the comparison has been made. It gives us merely a *relative*, and not an *absolute* measure. Just in the same way, if we are told that the pressure of



the steam in a boiler is equal to (say) 8 atmospheres (157), this statement does not in itself enable us to form any estimate of what the actual pressure of the steam is : it only tells us that, whatever the pressure of an atmosphere may be, that of the steam is 8 times as great. In order that we may be able to calculate what effects the pressure of the steam is capable of producing, we require to have it stated in *absolute* measure, that is—not how much greater or less it is than some other pressure—but what actual force is exerted by it on each unit of surface. So, for very many purposes we require absolute measures of electrical resistance, instead of mere comparisons of the resistance of one conductor with that of another.

To see how it is possible to get an absolute measure of resistance, we must go back to the fundamental meaning expressed by the term. If, by any means whatever, a definite electromotive force (difference of potential) is maintained between any two given cross-sections of a conductor, a constant electric current flows from one cross-section to the other, and, for the same conductor, *the ratio of the electromotive force to the strength of the resulting current is constant*. That is, if  $E_1, E_2, E_3, \dots$  be various values successively given to the electromotive force, and  $C_1, C_2, C_3, \dots$  be the corresponding strengths of the current, then

$$\frac{E_1}{C_1} = \frac{E_2}{C_2} = \frac{E_3}{C_3} = \dots = R \text{ (a constant).}$$

This constant ratio of electromotive force to strength of current, is characteristic of the individual conductor employed, and is called its *electrical resistance*. And, when the resistance of a conductor is stated as the value of the ratio in question, the statement gives us the absolute measure of the resistance : that is, it gives us definite information about the electrical properties of that particular conductor without implying a comparison of it with any other conductor.

Hence it appears that the absolute resistance of a given conductor is determined if we can ascertain the ratio of any electromotive force to the strength of the current which it is capable of producing in the conductor in question. It is not, however, needful to make an independent measurement of this ratio in the case of every conductor whose resistance we require to know : it is sufficient to determine it once for all for some one conductor, and then, taking this conductor as a standard, to compare the resistance of other conductors with that of this one, by means of Wheatstone's Bridge (911), or any other convenient method.

The methods available for determining the ratio between electromotive force and resistance, required for an absolute measurement of resistance, depend on the electromagnetic phenomena presented by electric conductors and currents ; it will be sufficient here to indicate the general principles upon which such methods can be founded. From what has been said it will be seen that any method for this purpose involves a measurement of electromotive force and a measurement of the strength of a current. It will be convenient to treat these two parts of the process separately.

A. *Absolute measurement of Electromotive Force*.—When any electric conductor is moved in a magnetic field, that is to say, in any region where there is magnetic force, an electromotive force is in general developed

in the conductor during its motion. The magnitude of this electromotive force depends upon the intensity of the magnetic field, on the length and form of the conductor, and on the velocity and direction of its motion. The simplest case is presented by a straight conductor, with its length perpendicular to the direction of the force in a uniform magnetic field, and moving at right angles to its length and to the direction of the force. If  $E$  be the intensity of the field,  $l$  the length of the conductor, and  $v$  the velocity, the electromotive force is

$$E = k \cdot Tlv,$$

where  $k$  is a constant, depending on the unit adopted for the measurement of electromotive force. If we define the unit of electromotive force as that which is developed in a *conductor of unit length moving* (in the way specified above) *with unit velocity in a magnetic field of unit intensity*, the constant  $k$  becomes = 1, and the value of  $E$  is

$$E = Tlv.$$

If the length and the direction of motion of the conductor are not at right angles to the direction of magnetic force, we must project both on a plane perpendicular to the direction of the force: thus if the conductor is inclined at an angle  $\alpha$ , and moves in a direction making an angle  $\beta$ , both being measured from the direction of magnetic force, the electromotive force becomes

$$E = Tl \sin \alpha \cdot v \sin \beta.$$

If the conductor is bent in any way, so that  $\alpha$  has different values for different parts, and if the direction or velocity of its motion varies from one part to another, we may conceive of it as divided into a great number of equal parts, each so small that no sensible variation of  $\alpha$ ,  $\beta$ , or  $v$ , can occur within it, we may calculate the electromotive force due to each of these small parts taken separately by the last formula, and then, adding all the results together, we obtain the electromotive force developed in the whole conductor. A little consideration will show that the following statement is equivalent to that just given: namely, the electromotive force generated in a conductor moving in any manner in a magnetic field is proportional at each instant to the *rate of variation of the area swept over by its projection on a plane perpendicular to the direction of the magnetic force*; and the average electromotive force acting in the conductor during any interval of time is proportional directly to the total area swept over by its projection during the interval, and inversely to the length of the interval.

In order to apply practically the principles that have been pointed out, it is most convenient to take advantage of the magnetic field due to the magnetism of the earth. Throughout any moderate space at a distance from magnets or masses of iron, the magnetic force due to the earth is uniform in intensity and direction. Suppose, then, a circular conducting ring, placed so that its plane is perpendicular to the direction of the earth's magnetic force—that is, to the direction of the dipping needle—to be turned through half a revolution about one of its diameters: we may regard its projection on a plane perpendicular to the direction of the earth's force to be made up of the projections of the two semicircles into which it is divided by the axis of rotation. During the half-turn made by the ring, the projection

of each semicircle sweeps through an area equal to that of the whole ring ; but one projection passes over this area in one direction, and the other in the opposite direction. Consequently, equal electromotive forces are generated in the two halves of the ring, in opposite directions as regarded from outside, but both in the same direction if considered as tending to produce a current round the ring : the total electromotive force is therefore the sum of the forces in the two halves, and if  $r$  be the radius of the ring and therefore  $\pi r^2$  its area, and  $n$  the number of revolutions per second, so that the time occupied by each half-revolution is  $\frac{1}{2n}$ , the average electromotive force acting in the ring as it rotates uniformly about a diameter, is

$$2T \cdot \pi r^2 + \frac{1}{2n} = 4T\pi r^2 n$$

where  $T$  stands for the whole intensity of the earth's magnetic force. If, instead of a single ring, we have a circular coil of wire of  $u$  convolutions and if the axis of rotation makes any angle  $\alpha$  with the line of dip, the electromotive force due to the rotation of the coil is

$$E = 4T\pi r^2 n u \sin \alpha.$$

Consequently the rotation of a coil of wire under the circumstances named, furnishes the means of obtaining an electromotive force, the absolute value of which is given by the intensity of the magnetic field, the dimensions and speed of the coil, and the position of its axis of rotation. If we can determine the strength of current which this electromotive force is capable of producing in a given conductor, the absolute resistance of the conductor is at once known.

B. *Absolute measurement of the Strength of Currents.*—The method of measuring the strength of electric currents is founded on the fact that a force is exerted between a conductor carrying a current and any magnetic pole in its neighbourhood. In general, both the distance and the direction, as seen from a given magnetic pole, vary from point to point of the conductor, so that it is generally impossible to give any simple statement of the law according to which a given current acts upon a magnetic pole in a given position. But, if we consider only a very small length of a current, neither the distance of its various points from a given magnetic pole, nor their directions, can vary to a sensible extent ; and when these two conditions are constant, the law of the force between the current and the pole may be stated as follows : As to direction, the force is perpendicular to a plane containing the current and the pole, and acts upon a north pole, towards the left hand of an observer looking at the pole from the line of the current, and so placed that the nominal direction of the current is from his feet to his head, or, upon a south pole, towards the right hand of an observer similarly placed ; as to magnitude, the force is proportional directly to the length ( $l$ ) and to the strength ( $C$ ) of the current, to the strength of the magnetic pole ( $m$ ), and to the sine of the angle ( $\theta$ ) made by the direction of the current with a straight line, drawn from it to the pole, and inversely to the square of the distance ( $r'$ ) from the current to the pole. Hence, if the force be denoted by  $f$ , we have

$$f = k \frac{Cml}{r'^2} \sin \theta,$$

where  $k$  is a constant, depending on the units in which the numerical values of the various quantities are expressed. If we define the unit strength of current as the strength of a current of which unit length, placed at unit distance from a magnetic pole of unit strength and making everywhere a right angle with a line drawn from it to the pole, exerts unit force on the pole,  $k$  becomes unity, and we have

$$f = \frac{Cml}{r^2} \sin \theta,$$

or

$$C = \frac{f r^2}{ml \sin \theta}.$$

The most convenient way of founding upon these principles a practical measurement of the strength of a current is to cause the current to go one or more times round a vertical circle of known radius placed in the plane of the magnetic meridian, with a very short magnet suspended at the centre. This is the arrangement of the tangent galvanometer already described (799). If  $H$  is the intensity of the horizontal component of the earth's magnetic force, the force which must be exerted upon each pole of a magnet, whose poles are of the strength  $+m$  and  $-m$ , in a direction perpendicular to the magnetic meridian, in order to deflect the magnet through an angle  $\gamma$  is

$$f = Hm \tan \gamma.$$

Putting this value of  $f$  into the expression given above for the strength of a current, we have

$$C = \frac{Hm \tan \gamma r^2}{ml \sin \theta}.$$

But in the case supposed, that of a tangent-galvanometer with the current going  $u'$  times round the circle, we have  $l = u'2\pi a$ , if  $a$  is the radius of the circle; moreover, the distance  $r'$  of each part of the current from the magnet is constant and equal to the radius, or  $r' = a$  and the angle  $\theta$  is also constant, being everywhere a right angle, so that  $\sin \theta = 1$ ; consequently we get for the strength of the current in absolute measure,

$$C = \frac{Hm u' r^2}{m u' 2\pi a} \tan \gamma = \frac{H r'}{2\pi u'} \tan \gamma.$$

We have thus shown how both electromotive force and strength of current can be measured in absolute units, and if these two measurements be combined, the ratio of the numerical value of the electromotive force, acting in a conductor, to that of the strength of the resulting current is the measure of the resistance of the conductor in question. Using the notation employed above, this leads to the following expression for the absolute measure of resistance,

$$R = \frac{E}{C} = \frac{4 T \pi r^2 u n \sin \alpha \cdot 2\pi u'}{H r' \tan \gamma}.$$

Various practical methods of measurement founded upon this principle have been devised, and when any of them is employed the value of the resistance under investigation is obtained by putting in this formula the values of electromotive force and strength of current that result from the particular arrangement adopted.

It may be observed with regard to the above expression, that the factors

$\pi$ ,  $u$ ,  $u'$ ,  $\sin \alpha$  and  $\tan \beta$ , are all of them simple numbers, that  $T$  and  $H$  are quantities of the same kind, so that their ratio is also a pure number. The only factors which involve reference to physical units are therefore  $r^2$ ,  $r'$  and  $\pi$ , and the two former being both distances, the ratio  $r^2 + r'$  is the first power of a distance, while  $u$ , the number of revolutions per unit of time is the reciprocal of the time occupied by a single revolution. Hence the expression for the absolute resistance of a conductor is in all cases reducible to

$$\frac{\text{a distance}}{\text{a time}} \times \text{a numerical factor};$$

that is to say electrical resistance may be expressed in terms of the units of length (or distance) and time in the same manner as a velocity, and the natural unit of resistance, like the natural unit of velocity, would be represented by a unit of length per unit of time. If, as is frequently done for scientific purposes, we adopt the centimetre as unit of length and the second as unit of time, the absolute unit of resistance becomes 1 *centimetre per second*; such a resistance, however, is so small that resistances commonly occurring in practice would have to be represented by inconveniently great multiples of it. As a practical standard of resistance, it is therefore more usual to employ the 'ohm,' which is a resistance of one thousand million centimetres per second, or

$$\frac{10^9 \text{ centimetres}}{1 \text{ second}}.$$

911. **Wheatstone's bridge.**—The various methods of determining the electrical conductivity of a body consist essentially in ascertaining the ratio between the resistance of a certain length of the conductor in question, having a given section, to that of a known length of a known section of some substance taken as standard. The most convenient method of ascertaining experimentally the ratio between the resistance of two conductors is by a method known as that of *Wheatstone's bridge*, the general principle of which may be thus stated:—

The conductors, which may be denoted by  $AB$  and  $BC$ , are connected end to end as shown in fig. 794, and one end of each is also connected with

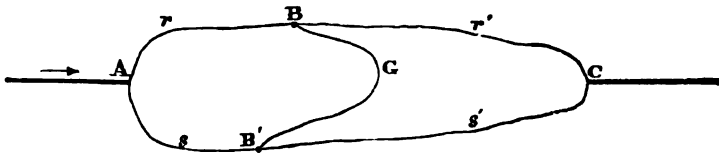

Fig. 794.

a battery, say the end  $A$  of  $AB$  with the positive pole, and the end  $C$  of  $BC$  with the negative pole; the ends that are in connection with the battery are likewise connected together by another conductor  $AB'C$ . A current will thus pass from  $A$  to  $C$  by each of the two paths  $ABC$  and  $AB'C$ , and there will be a gradual fall of potential in passing from  $A$  to  $C$  along either path, so that for every point in the conductors  $AB$  and  $BC$ , there is a point in the

wire AB'C which has the same potential. If one end of a galvanometer wire BGB' be connected with the point of junction B, the point of AB'C which has the same potential as the point B can be found by applying the other end of the galvanometer wire to AB'C, and shifting the point of contact towards A or C until the galvanometer shows no deflection. Let B' be the point so found; the fact that when it is connected with B by the bridge BGB' no current passes from one to the other proves that the potential at B' is the same as the potential at B. From this it follows that if  $r$  and  $r'$  are the resistances of AB and BC respectively, and  $s$  and  $s_1$  the resistances of AB' and B'C,

$$r : r' = s : s_1.$$

If the conductor AB'C is a wire of uniform material and diameter, the ratio of the resistances  $s$  and  $s_1$  will be the ratio of the lengths of the corresponding portions of wire, and can therefore be at once readily ascertained.

To prove this, let MN, NO, MN' and N'O' (fig. 795) be taken in the same straight line, proportional respectively to the several resistances  $r, r', s, s_1$ ; and let MP be drawn at right angles to O'MO of a length proportional to the difference of potential between the points A and C. Then if the straight lines PO and PO' be drawn, the potential at N (the point of junction of the conductors whose resistances  $r$  and  $r'$  are to be compared—*i.e.* the point corresponding to B in the previous figure) will be given by the length of the line NQ, drawn from N at right angles to NO; and the point N' (corresponding to B' in the previous figure) where the potential is the same

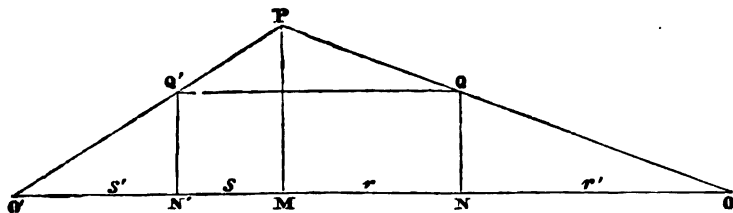

Fig. 795.

as at N will be found by drawing QQ' parallel to OO', and letting fall from Q' the perpendicular Q'N' upon O'M. The geometry of the figure gives obviously

$$\frac{r}{r+r'} = \frac{NQ}{MP} \text{ and } \frac{s'}{s+s'} = \frac{N_1Q_1}{MP},$$

and therefore since  $NQ = N_1Q_1$

$$\frac{r}{r'} = \frac{s}{s'}.$$

The resistance of a galvanometer may be determined by making it one of the four conductors of a Wheatstone's bridge arrangement; replacing it in the bridge by an ordinary contact key. The resistances of the other conductors are then altered until, on making contact, the deflection of the galvanometer is constant.

912. **Equivalent conductors.**—The resistance of a conductor depends, as we have seen (801), on its length, section, and conductivity. Two conductors, C and C', whose length, conductivity, and section are respectively  $\lambda\lambda'$ ,  $\kappa\kappa'$ ,  $\omega\omega'$ , would offer the same resistance, and might be substituted for each other in any voltaic circuit, without altering its intensity, provided that  $\frac{\lambda}{\kappa\omega} = \frac{\lambda'}{\kappa'\omega'}$ ; and such conductors are said to be *equivalent* to each other. An example will best illustrate the application of this principle.

It is required to know what length of a cylindrical copper wire 4 mm. in diameter would be equivalent to 12 metres of copper wire 1 mm. in diameter.

Let  $\lambda = 12$  the length of the copper wire 1 mm. in diameter, and  $\lambda'$  the length of the other wire; then since in this case the material is the same, the conductivity is the same, and the equation becomes  $\frac{\lambda}{\omega} = \frac{\lambda'}{\omega'}$ . Now the sections of the wires are directly as the squares of the diameters, and hence we have  $\frac{12}{1} = \frac{\lambda'}{4^2}$ , or  $\lambda' = 12 \times 16 = 192$ . That is, 192 metres of copper wire 4 mm. in thickness would only offer the same resistance as 12 metres of copper wire 1 mm. in thickness.

How thick must an iron wire be which for the same length shall offer the same resistance as a copper wire 2.5 mm. in diameter?

Here, the length being the same, the expression becomes  $\kappa\omega = \kappa'\omega'$ , or since the sections are as the squares of the diameters,  $\kappa d^2 = \kappa' d'^2$ . The conductivity of copper is unity, and that of iron 0.138. Hence we have  $2.5^2 = d'^2 \times 0.138$  or  $d'^2 = 6.25 \div 0.138 = 45.3$  mm. or  $d' = 6.7$  mm. That is, any length of a copper wire 2.5 mm. in diameter might be replaced by iron wire of the same length, provided its diameter were 6.7 mm.

913. **Determination of the internal resistance of an element.**—The following is a method of determining the internal resistance of an element. A circuit is formed consisting of one element, a rheostat, and a galvanometer, and the strength C is noted on the galvanometer. A second element is then joined with the first, so as to form one of double the size, and therefore half the resistance, and then by adding a length,  $l$ , of the rheostat wire, the strength is brought to what it originally was. Then if E is the electromotive force, and R the resistance of an element,  $r$ , the resistance of the galvanometer and the other parts of the circuit; the strength C in the one case is  $C = \frac{E}{R+r}$ , and in the other  $= \frac{E}{\frac{1}{2}R+r+l}$ , and since the strength in both cases is the same,  $R = 2l$ .

914. **Electrical conductivity.**—We can regard conductors in two aspects, and consider them as endowed with a greater or less facility for allowing electricity to traverse them, a property which is termed *conductivity*: or we may consider conductors interposed in a circuit as offering an obstacle to the passage of electricity—that is, a resistance which it must overcome. A good conductor offers a feeble resistance, and a bad conductor a great resistance. Conductivity and resistance are the inverse of each other.

The conductivity of metals has been investigated by many physicists by methods analogous in general to that described in the preceding paragraph,

and very different results have been obtained. This arises mainly from the various degrees of purity of the specimens investigated, but their molecular condition has also great influence. Matthiessen finds the difference in conductivity between hard-drawn and annealed silver wire to amount to 8.5, for copper 2.2, and for gold 1.9 per cent. The following are results of a series of careful experiments by Matthiessen on the electrical conductivity of metals at 0° C. compared with silver as a standard :—

Silver . . . . .	100.0	Iron . . . . .	16.8
Copper . . . . .	99.9	Tin . . . . .	13.1
Gold . . . . .	80.0	Lead . . . . .	8.3
Aluminium . . . . .	56.0	German Silver . . . . .	7.7
Sodium . . . . .	37.4	Antimony . . . . .	4.6
Zinc . . . . .	29.0	Mercury . . . . .	1.6
Cadmium . . . . .	23.7	Bismuth . . . . .	1.2
Potassium . . . . .	20.8	Graphite . . . . .	0.07
Platinum . . . . .	18.0		

The conductivity of metals is *diminished* by an increase in temperature. The law of this diminution is expressed by the formula

$$\kappa_t = \kappa_0 (1 - at + bt^2) ;$$

where  $\kappa$  and  $\kappa_0$  are the conductivities at  $t$  and 0° respectively, and  $a$  and  $b$  are constants, which are probably the same for all pure metals. For ten metals investigated by Matthiessen he found that the conductivity is expressed by the formula

$$\kappa_t = \kappa_0 (1 - 0.0037647t + 0.00000834t^2).$$

Liquids are infinitely worse conductors than metals. The conductivity of a solution of one part of chloride of sodium in 100 parts of water is  $\frac{1}{30000000}$  that of copper. In general acids have the highest and solutions of alkalis and neutral salts the lowest conductivity. Yet, in solutions, the conductivity does not increase in direct proportion to the quantity of salt dissolved.

The following is a list of the conductivity of a few liquids as compared with that of pure silver.

Pure silver . . . . .	100,000,000.00
Nitrate of copper, saturated solution . . . . .	8.99
Sulphate of copper ditto . . . . .	5.42
Chloride of sodium ditto . . . . .	31.52
Sulphate of zinc ditto . . . . .	5.77
Sulphuric acid, 1.10 sp. gr. . . . .	99.07
"    "    1.24 sp. gr. . . . .	132.75
"    "    1.40 sp. gr. . . . .	90.75
Nitric acid, commercial . . . . .	88.68
Distilled water . . . . .	0.01

Liquids and fused conductors increase in conductivity by an increase of temperature. This increase is expressed by the formula

$$\kappa_t = \kappa_0 (1 + at),$$



and the values of  $a$  are considerable. Thus, for a saturated solution of sulphate of copper, it is 0.0286.

An influence of *light* upon electrical conductivity has been ascertained to exist in the case of selenium. A thin strip of this metalloid, about 38 mm. in length, by 13 in breadth, was provided at the ends with conducting wires and placed in a box with a draw-lid. The selenium, having been carefully balanced in a Wheatstone's bridge, was exposed to diffused light by withdrawing the lid, when the resistance at once fell in the ratio of 11 to 9. On exposure to the various spectral colours, after having been in the dark, it was found to be most affected by the red; but the maximum action was just outside the red, where the resistance fell in the ratio of 3 to 2. Momentary exposure to the light of a gas lamp or even to that of a candle causes a diminution of resistance. Exposure to full sunlight diminished the resistance to one half.

The effect produced on exposure to light is immediate, while recurrence to the normal state takes place more slowly. A vessel of hot water placed near the strip produced no effect, and hence the phenomenon cannot be due to heat, but there appear to be certain rays which have the power of producing a molecular change in the selenium by which its conductivity is increased.

915. **Determination of electromotive force. Wheatstone's method.**—In the circuit of the element whose electromotive force is to be determined a tangent compass and a rheostat are inserted, the latter being so arranged that the strength,  $C$ , of the current is a definite amount; for example, the galvanometer indicates  $45^\circ$ . By increasing the amount of the rheostat wire by the length  $l$ , a diminished strength,  $c$  (for instance,  $40^\circ$ ), is obtained.

A second standard element is then substituted for that under trial, and by arranging the rheostat, the strength of the current is first made equal to  $C$ , and then, by addition of  $l$  lengths of the rheostat, is made  $= c$ .

Then if  $E$  and  $E_1$  are the two electromotive forces,  $R$  and  $R_1$  their resistances when they have the intensity  $l$ , and  $l$  and  $l_1$  the lengths added, we have

Trial Element.

$$C = \frac{E}{R}$$

$$c = \frac{E}{R + l}$$

Standard Element.

$$C = \frac{E_1}{R_1}$$

$$c = \frac{E_1}{R_1 + l_1}$$

from which we have

$$E = E_1 \frac{l}{l_1}$$

Hence the electromotive forces of the elements compared are directly as the lengths of the wire interposed.

Another method is described by Wiedemann. The two elements are connected in the same circuit with a tangent galvanometer, or other apparatus for measuring strength, first in such a manner that their currents go in the same direction, and secondly that they are opposed. Then if the electromotive forces are  $E$  and  $E'$ , their resistances are  $R$  and  $R'$ , the other

resistances in the circuits  $r$ , while  $C$ , is the intensity when the elements are in the same direction, and  $C_1$  the intensity when they go in opposite directions, then :

$$C = \frac{E + E'}{R + R' + r}$$

and

$$C_1 = \frac{E - E'}{R + R' + r},$$

whence

$$E' = \frac{E(C - C_1)}{C + C_1}.$$

916. **Siemens' electrical resistance thermometer.**—Supposing in a Wheatstone's bridge arrangement, after the ratio  $r : r_1 = s : s_1$  has been established, the temperature of one of the coils,  $r$ , for instance, be increased, the above ratio will no longer prevail, for the resistance of  $r$  will have been altered by the temperature, and the ratio of  $s$  and  $s_1$  must be altered so as to produce equivalence. On this idea Siemens has based a mode of observing the temperature of places which are difficult of direct access. He places a coil of known resistance in the particular locality whose temperature is to be observed ; it is connected by means of long good conducting wires with the place of observation, where it forms part of a Wheatstone's bridge arrangement. The resistance of the coil is known in terms of the rheostat, and by preliminary trials it has been ascertained how much additional wire must be introduced to balance a given increase in the temperature of the resistance coil. This being known, and the apparatus adjusted at the ordinary temperature, when the temperature of the resistance coil varies, this variation in either direction is at once known by observing the quantity which must be brought in or out of the rheostat to produce equivalence.

This apparatus has been of essential service in watching the temperature of large coils of telegraph wire, which, stowed away in the hold of vessels, are very liable to become heated. It might also be used for the continuous and convenient observation of underground and submarine temperatures. If a coil of platinum wire were substituted for the copper, the apparatus could be used for watching the temperature of the interior of a furnace.

917. **Derived currents.**—In fig. 796 the current from a Bunsen's element traverses the wire  $rqpnm$  : let us take the case in which any two points of

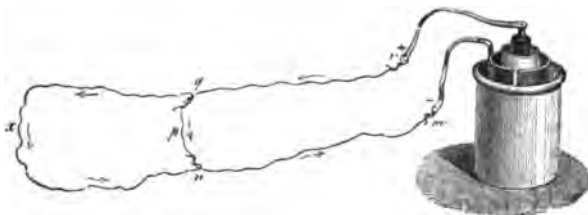

Fig. 796.

this circuit,  $n$  and  $q$ , are joined by a second wire,  $nq$ . The current will then

divide at the point  $q$  into two others, one of which goes in the direction  $qpnm$ , while another takes the direction  $qxn$ . The two points  $q$  and  $n$  from which the second conductor starts and ends are called the *points of derivation*, the wire  $qpn$  and the wire  $qxn$  are *derived wires*. The currents which traverse these wires are called the *derived or partial currents*; the current which traversed the circuit  $rqpnm$  before it branches is the *primitive current*: and the name *principal current* is given to the whole of the current which traverses the circuit when the derived wire has been added. The principal current is stronger than the primitive one, because the interposition of the wire  $qxn$  lessens the total resistance of the circuit.

If the two derived wires are of the same length and the same section, their action would be the same as if they were juxtaposed, and they might be replaced by a single wire of the same length but of twice the section and therefore with half the resistance. Hence the current would divide into two equal parts along the two conductors.

When the two wires are of the same length but of different sections, the current would divide unequally, and the quantity which traversed each wire would be proportional to its section, just as when a river divides into two branches, the quantity of water which passes in each branch is proportional to its dimensions. Hence the resistance of the two conductors joined would be the same as that of a single wire of the same length, the section of which would be the sum of the two sections.

If the two conductors  $qpn$  and  $qxn$  are different, both in kind, length, and section they could always be replaced by two wires of the same kind and length, with such sections that their resistances would be equal to the two conductors; in short, they might be replaced by equivalent conductors. These two wires would produce in the circuit the same effect as a single wire, which had this common length, and whose section would be the sum of the sections thus calculated. The current divides at the junction into two parts proportional to these sections, or inversely as the resistances of the two wires.

Suppose, for instance,  $qpn$  is an iron wire 5 metres in length and 3 mm. square in section, and  $qxn$  a copper wire.

The first might be replaced by a copper wire a metre in length, whose section would be  $\frac{3}{5} \times \frac{1}{7}$  (taking the conductivity of copper at 7 times that of iron) or  $\frac{3}{35}$  square mm. The second wire might be replaced by a copper wire a metre in length with a section of  $\frac{2}{9}$  square mm. These two wires would present the same resistance as a copper wire a metre in length, and with a section of  $\frac{3}{35} + \frac{2}{9} = \frac{97}{315}$  square millimetres.

The principal current would divide along the wires in two portions, which would be as  $\frac{3}{35} : \frac{2}{9}$ .

The most important laws of divided circuits are as follows:—

- i. *The sum of the strengths in the divided parts of a circuit is equal to the strength of the principal current.*
- ii. *The strengths of the currents in the divided parts of a circuit are inversely as their resistances; or, what is the same, the division of a current into partial currents which lie between two points is directly as the respective conductivities of these branches.*

And as problems on divided circuits frequently occur in telegraphy,

the following formulæ, which include these laws, are given for a simple case.

If  $C$  be the strength of the current in the undivided part of the circuit  $rqpnm$  and if  $c$  is the strength in one branch (say in the above figure  $qpn$  and  $c'$  in  $qxn$ ; if  $R$ ,  $r$ , and  $r_1$  are the corresponding resistances, the electromotive force being  $E$ , then

$$C = \frac{E(r+r_1)}{Rr + Rr_1 + rr_1}$$

$$c = \frac{E r_1}{Rr + Rr_1 + rr_1}$$

$$c' = \frac{E r}{Rr + Rr_1 + rr_1}$$

The resistance  $R_1$  of the whole circuit through which the current circulates is

$$R_1 = R + \frac{rr_1}{r+r_1},$$

and therefore the total resistance of the derived currents  $qpn$  and  $qxn$  is

$$\frac{rr_1}{r+r_1}.$$

## CHAPTER X.

### ANIMAL ELECTRICITY.

918. **Muscular currents.**—The existence of electrical currents in living muscle was first indicated by Galvani, but his researches fell into oblivion after the discovery of the Voltaic pile, which was supposed to explain all the phenomena. Since then, Nobili, Matteucci, and others, especially, in late years, Du Bois Reymond, have shown that electric currents do exist in living muscles and nerves, and have investigated their laws.

For investigating these currents it is necessary to have a delicate galvanometer, and also electrodes which will not become polarised or give a current of their own, and which will not in any way alter the muscle when placed in contact with it; the electrodes which satisfy these conditions best are those of Du Bois Reymond, as modified by Donders. Each consists of a glass tube, one end of which is narrowed and stopped by a plug of paste made by moistening china-clay with a half per cent. solution of common salt; the tube is then partially filled with a saturated solution of sulphate of zinc, and into this dips the end of a piece of thoroughly amalgamated zinc wire, the other end of which is connected by a copper wire with the galvanometer; the moistened china-clay is a conducting medium which is perfectly neutral to the muscle, and amalgamated zinc in solution of sulphate of zinc does not become polarised.

919. **Currents of muscle at rest.**—In describing these experiments the surface of the muscle is called the *natural longitudinal section*; the tendon, the *natural transverse section*; and the surfaces obtained by cutting the

muscle longitudinally or transversely are respectively the *artificial longitudinal* and *artificial transverse sections*.

If a living irritable muscle be removed from a recently killed frog, and the clay of one electrode be placed in contact with its surface, and of the other with its tendon, the galvanometer will indicate a current from the former to the latter; showing, therefore, that the surface of the muscle is positive with respect to the tendon. By varying the position of the electrodes, and making various artificial sections, it is found—

1. That any longitudinal section is positive to any transverse.
2. That any point of a longitudinal section nearer the middle of the muscle is positive to any other point of the same section farther from the centre.
3. In any artificial transverse section any point nearer the periphery is positive to one nearer the centre.
4. The current obtained between two points in a longitudinal or in a transverse section is always much more feeble than that obtained between two different sections.
5. No current is obtained if two points of the same section equidistant from its centre be taken.
6. To obtain these currents it is not necessary to employ a whole muscle, or a considerable part of one, but the smallest fragment that can be experimented with is sufficient.
7. If a muscle be cut straight across, the most powerful current is that from the centre of the natural longitudinal section to the centre of the artificial transverse; but if the muscle be cut across obliquely, as in fig. 797, the



Fig. 797.

most positive point is moved from *c* towards *b*, and the most negative from *d* towards *a* (*Currents of inclination*).

To explain the existence and relations of these muscular currents, it may be supposed that each muscle is made up of regularly disposed electromotor elements, which may be regarded as cylinders whose axes are parallel to that of the muscle, and whose sides are charged with positive and their ends with negative electricity; and, further, that all are suspended and enveloped in a conducting medium. In such a case (fig. 798), it is clear that throughout most of the muscle the positive electricities of the opposed surfaces would neutralise one another, as would also the negative charges of the ends of the cylinders; so that, so long as the muscle was intact, only the charges at its sides and ends would be left free to manifest themselves by the production of electromotive phenomena; the whole muscle being enveloped in a conducting stratum, a current would constantly be passing from the longitudinal to the transverse section, and, a part of this being led off by the wire circuit, would manifest itself in the galvanometer.

This theory also explains the currents between two different points on

the same section ; the positive charge at *b*, for instance (fig. 798), would have more resistance to overcome in getting to the transverse section than that at *d*, therefore it has a higher tension ; and if *b* and *d* are connected by the

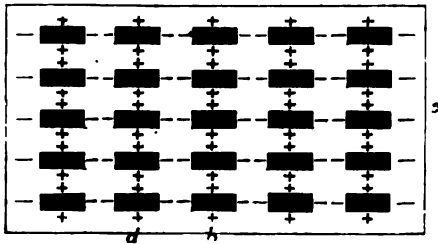

Fig. 798.

electrodes, *b* will be found positive to *d*, and a current will pass from the former to the latter.

What are called *currents of inclination* are also explicable on the above hypothesis, for the oblique section can be represented as a number of elements arranged as in fig. 799, so that both the longitudinal surfaces and the ends

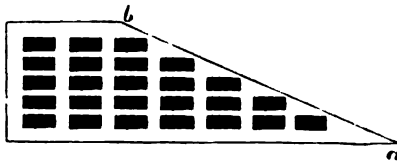

Fig. 799.

of the cylinders are laid bare, and it can thus be regarded as a sort of oblique pile whose positive pole is towards *b* and its negative at *a*, and whose current adds itself algebraically to the ordinary current and displaces its poles as above mentioned.

A perfectly fresh muscle, very carefully removed, with the least possible contact with foreign matters, sometimes gives almost no current between its different natural sections, and the current always becomes more marked after the muscle has been exposed a short time ; nevertheless, the phenomena are vital, for the currents disappear completely with the life of the muscle, sometimes becoming first irregular or even reversed in direction.

920. **Rheoscopic frog. Contraction without metals.**—The existence of the muscular currents can be manifested without a galvanometer, by using another muscle as a galvanoscope. Thus if the nerve of one living muscle be dropped suddenly on another living muscle, so as to come in contact with its longitudinal and transverse sections, a contraction of the first muscle will occur, due to the stimulation of its nerve by the passage through it of the electric current derived from the surface of the second.

921. **Currents in active muscle.**—When a muscle is made to contract there occurs a sudden diminution of its natural electric current, as indicated by the galvanometer. This is so instantaneous that, in the case of a single

muscular contraction it does not overcome the inertia of the needle of the galvanometer ; but if the contractions be made to succeed one another very rapidly—that is, if the muscle be *tetanised* (803)—then the needle swings steadily back towards zero from the position in which the current of the resting muscle had kept it, often gaining such momentum in the swing as to pass beyond the zero point, but soon reverting to some point between zero and its original position.

The negative variation in the case of a simple muscular contraction can, however, be made manifest by using another muscle as a rheoscope ; if the nerve of this second muscle be laid over the first muscle in such a position that the muscular current passes through it, and the first muscle be then made to contract, the sudden alteration in the strength of its current stimulates the nerve laid on it (803), and so causes a contraction of the muscle to which the latter belongs.

The same phenomena can be demonstrated in the muscles of warm-blooded animals ; but with less ease, on account of the difficulty of keeping them alive after they are laid bare or removed from the body. Experiments made by placing electrodes outside the skin, or passing them through it are inexact and unsatisfactory.

922. **Electric currents in nerve.**—From nerves the same electromotor indications can be obtained as from muscles ; at least, as far as their smaller size will permit ; the currents are more feeble than the muscular ones, but can be demonstrated by the galvanometer in a similar way. Negative variation has been proved to occur in active nerve as in active muscle. The effect of a constant current passed through one part of a nerve on the amount of the normal nerve current, measured at another part, has already been described (Chap. III., Electrotonus).

923. **Electrical fish.**—Electrical fish are those fish which have the remarkable property of giving, when touched, shocks like those of the Leyden jar. Of these fish there are several species, the best known of which are the torpedo, the gymnotus, and the silurus. The torpedo, which is very common in the Mediterranean, has been carefully studied by MM. Becquerel and Breschet in France, and by M. Matteucci in Italy. The gymnotus has been investigated by Humboldt and Bonpland in South America, and in England by Faraday, who had the opportunity of examining live specimens.

The shock which they give serves both as a means of offence and of defence. It is purely voluntary, and becomes gradually weaker as it is repeated and as these animals lose their vitality, for the electrical action soon exhausts them materially.

The shock is very violent. According to Faraday, the shock which the gymnotus gives is equal to that of a battery of 15 jars exposing a coating of 25 square feet, which explains how it is that horses frequently give way under the repeated attacks of the gymnotus.

Numerous experiments show that these shocks are due to ordinary electricity. For if, touching with one hand the back of the animal, the belly is touched with the other, or with a metal rod, a violent shock is felt in the wrists and arms ; while no shock is felt if the animal is touched with an insulating body. Further when the back is connected with one end of a galvanometer wire and the belly with the other, at each discharge the needle

is deflected but immediately turns to zero, which shows that there is an instantaneous current; and, moreover, the direction of the needle shows that the current goes from the back to the belly of the fish. Lastly, if the current of a torpedo be passed through a helix in the centre of which is a small steel bar, the latter is magnetised by the passage of a discharge.

By means of the galvanometer, Matteucci has established the following facts:—

1. When a torpedo is lively, it can give a shock in any part of its body; but as its vitality diminishes, the parts at which it can give a shock are nearer the organ which is the seat of the development of electricity.

2. Any point of the back is always positive as compared with the corresponding point of the belly.

3. Of any two points at different distances from the electrical organ, the nearest always plays the part of a positive pole, and the furthest that of negative pole. With the belly the reverse is the case.

The organ where the electricity is produced in the torpedo is double, and formed of two parts symmetrically situated on the two sides of the head, and attached to the skull bone by the internal face. Each part consists of nearly parallel lamellæ of connective tissue inclosing small chambers, in which lie the so-called *electrical plates*, each of which has a final nerve ramification distributed on one of its faces. This face, on which the nerve ends, is turned the same way in all the plates, and when the discharge takes place is always negative to the other.

Matteucci investigated the influence of the brain on the discharge. For this purpose he laid bare the brain of a living torpedo, and found that the first three lobes could be irritated without the discharge being produced, and that when they were removed the animal still possessed the faculty of giving a shock. The fourth lobe, on the contrary, could not be irritated without an immediate production of the discharge; but if it was removed, all disengagement of electricity disappeared, even if the other lobes remained untouched. Hence it would appear that the primary source of the electricity elaborated is the fourth lobe, whence it is transmitted by means of the nerves to the two organs described above, which act as multipliers. In the silurus the head appears also to be the seat of the electricity; but in the gymnotus it is found in the tail.

924. **Application of electricity to medicine.**—The first applications of electricity to medicine date from the discovery of the Leyden jar. Nollet and Boze appear to have been the first who thought of the application, and soon the spark and electrical frictions became a universal panacea, but it must be admitted that subsequent trials did not come up to the hopes of the experimentalists.

After the discovery of dynamic electricity Galvani proposed its application to medicine; since which time many physicists and physiologists have been engaged upon this subject, and yet there is still much uncertainty as to the real effects of electricity, the cases in which it is to be applied, and the best mode of applying it. Practical men prefer the use of currents to that of statical electricity, and, except in a few cases, discontinuous to continuous currents. There is, finally, a choice between the currents of the battery



and those of induction currents ; further, the effects of the latter differ, according as induction currents of the first or second order are used.

In fact, since induction currents, although very intense, have a very feeble chemical action, it follows that when they traverse the organs, they do not produce the chemical effects of the current of the battery, and hence do not tend to produce the same disorganisation. Further, in electrifying the muscles of the face, induction currents are to be preferred, for Dr. Duchenne has found that these currents only act feebly on the retina, while the currents of the battery act energetically on this organ, and may affect it dangerously, as serious accidents have shown. There is a difference in the action of induced currents of different orders : for while the primary induced current causes lively muscular actions, but has little action on the cutaneous sensibility, the secondary induced current, on the contrary, increases the cutaneous sensibility to such a point that its use ought to be proscribed to persons whose skin is very irritable.

Hence electrical currents should not be applied in therapeutics without a thorough knowledge of their various properties. They ought to be used with great prudence, for their continued action may produce serious accidents. Matteucci, in his lectures on the physical phenomena of living bodies expresses himself as follows : ' In commencing, a feeble current must always be used. This precaution now seems to me the more important, as I did not think it so before seeing a paralytic person seized with almost tetanic convulsions under the action of a current formed of a single element. Take care not to continue the application too long, especially if the current is energetic. Rather apply a frequently-interrupted current than a continuous one, especially if it be strong ; but after twenty or thirty shocks, at most, let the patient take a few moments' rest.'

Of late years, however, feeble continuous currents have come more into use. They are frequently of great service when applied skilfully so as to throw the nerves of the diseased part into a state of cathelectrotonus or anelectrotonus (804), according to the object which is wished for in any given case.

ELEMENTARY OUTLINES  
OF  
METEOROLOGY AND CLIMATOLOGY.

---

METEOROLOGY.

925. **Meteorology.**—The phenomena which are produced in the atmosphere are called *meteors*; and *meteorology* is that part of physics which is concerned with the study of these phenomena.

A distinction is made between *aerial* meteors, such as winds, and hurricanes, and whirlwinds; *aqueous* meteors, comprising fogs, clouds, rain, dew, snow, and hail; and *luminous* meteors, as lightning, the rainbow, the aurora borealis.

926. **Meteorograph.**—The importance of being able to make continuous observations of various meteorological phenomena has led to the construction of various forms of automatic arrangements for this purpose, of which that of Osler in England may be specially mentioned. One of the most comprehensive and complete is Secchi's *meteorograph*, of which we will give here a description.

It consists of a base of masonry about 2 feet high, fig. 800; on this are fixed four columns, about  $2\frac{1}{2}$  yards high, which support a table on which is a clockwork regulating the whole of the movements of the machine. The phenomena are registered on two sheets which move downwards on two opposite sides, their motion being regulated by clockwork. One of them occupies 10 days in so doing, and on it are registered the direction and velocity of the wind, the temperature of the air, the height of the barometer, and the occurrence of rain; on the second, which only takes two days, the barometric height and the occurrence of rain are repeated, but on a much larger scale; this gives, moreover, the moisture of the air.

*Direction of the wind.*—The four principal directions of the wind are registered by means of four pencils fixed at the top of thin brass rods, *a*, *b*, *c*, *d*, fig. 800, which are provided at the bottom ends with soft iron keepers attracted by two electro-magnets, E, E', for west and north, and by two other electro-magnets lower down for south and east. These four electro-magnets, as well as all the others on the apparatus, are worked by a single sand battery (857) of twenty-four elements. The passage of the current in one or the other of these electro-magnets is regulated by means of a vane (fig. 801)

consisting of two plates at an angle of thirty degrees with each other, by which greater steadiness is obtained than with a single plate. In the rod of

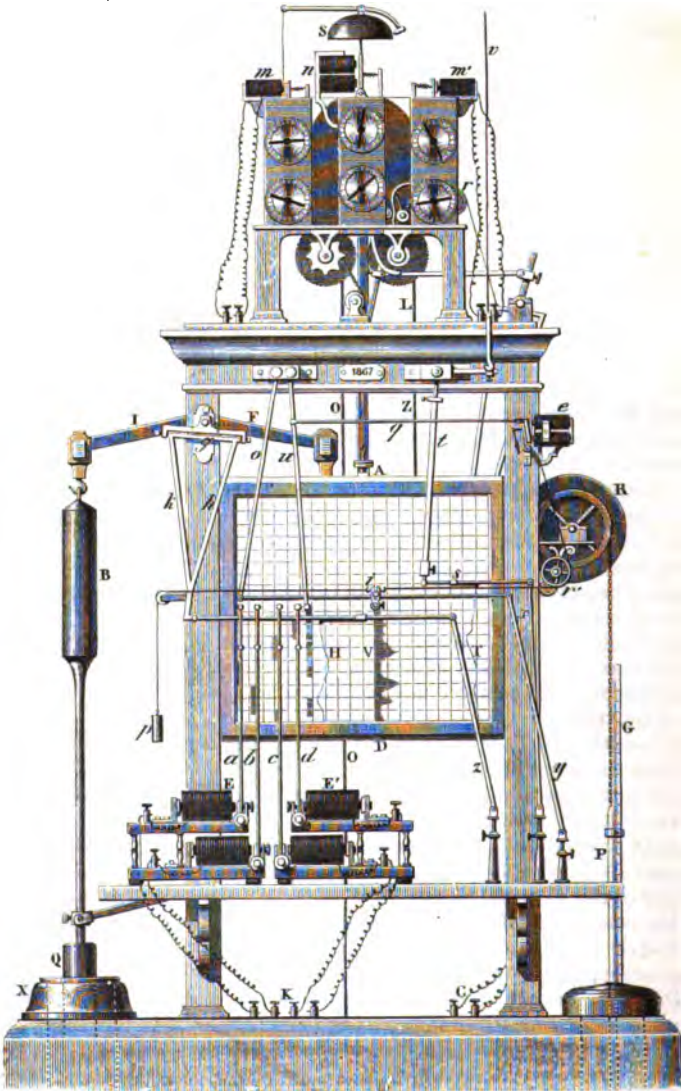

Fig. 800.

the vane is a small brass plate *o*; this part is in the centre of four metal sectors, insulated from each other, and each provided with a binding screw,

by which connection is established with the binding screw K, and the electro-magnets E E'. The battery current reaches the rod of the vane by the wire  $a$ , and thence the sliding contact  $o$ , which leads it to the electro-magnet for the north for instance.

If the current passed constantly in this electro-magnet, the pencil on the rod  $d$  would be stationary; but from the electro-magnet E', the current passes into a second electro-magnet  $n$ , over the clockwork, and is thereby alternately opened and closed, as will be seen in speaking of the velocity of the wind. Hence the armature of the rod  $d$ , alternately free and attracted, oscillates, and its pencil, which is always pressed against the paper AD by the elasticity of the rod, traces on it a series of parallel dashes, as the paper descends, and so long as the wind is in the north. If the wind changes then to west for instance, the rod  $a$ , oscillates, and its pencil traces a different series of marks. The rate of displacement of the paper being known, we get the direction of the prevalent wind at a given moment.

*Velocity of the wind.*—This is indicated by a Robinson's anemometer, and is registered in two ways; by two counters which mark in decametres and kilometres the distance travelled by the wind; and by a pencil which traces on a table a curve, the ordinates of which are proportional to the velocity of the wind.

Robinson, who originally devised this form of anemometer (fig. 802), proved that its velocity is proportional to that of the wind; in the present apparatus the length of the arms is so calculated that each revolution corresponds to a velocity of ten metres (927). The anemometer is placed at a considerable distance from the meteorograph, and is connected with it by a copper wire  $d$ , which passes to the electro-magnet  $n$  of the counter. On its rod, there is, moreover, an excentric, which at each turn touches a metallic contact in connection with the wire  $d$ . The battery current reaching the anemometer by a wire  $a$ , the current is closed once at each rotation, and passes to the electro-magnet  $n$ , which moves the needle of the



Fig. 801.

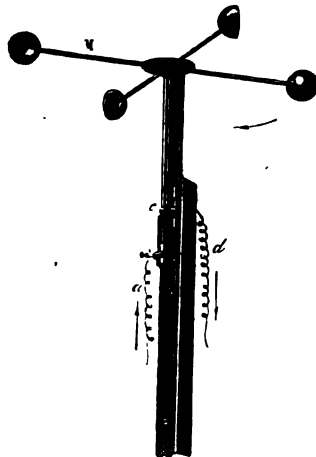

Fig. 802.

dial through one division. There are fifty such divisions which represent as many turns of the vane, and therefore so many multiples of ten metres. The lower dial marks the kilometres.

The curve of velocities is traced on the sheet by a pencil  $i$ , fixed to a horizontal rod. This is joined at its two ends to two guide rods  $o$  and  $y$ , which keep it parallel. The pencil and the rod are moved laterally by a chain which passes over two pulleys  $r'$  and  $r$ , and is then coiled over a pulley placed on the shaft of the counter, but connected with it merely by a ratchet wheel; and moved thus by the counter and the chain, the pencil traces every hour on the sheet a line the length of which is proportioned to the velocity of the wind. From hour to hour an excentric moved by clockwork, detaches from the shaft of the counter the pulley on which is coiled the chain, and this pulley becoming out of gear a weight  $h$ , connected with the pencil  $i$ , restores this to its starting point. All the lines  $v$ , traced successively by the pencil start from the same straight line as ordinates, and their ends give the curve of velocities.

The counters on the right and left are worked by electro-magnets  $m m'$ , and are intended to denote the velocity of special winds, for instance, those of the north and south, by connecting their electro-magnets with the north and south sectors of the V vane (fig. 801).

*Temperature of the air.*—This is indicated by the expansion and contraction of a copper wire 16 metres in length stretched backwards and forwards on a fir post 8 metres in length. The whole being placed on the outside, on the roof for instance, the expansion and contraction are transmitted by a system of levers to a wire  $o$ , which passes to the meteorograph, where it is joined to a bent lever  $t$ . This is jointed to a horizontal rod  $s$  which supports a pencil, and at the other end is jointed with a guide rod  $a$ . Thus the pencil sharing the oscillations of the whole system traces the curve of the temperatures.

*Pressure of the atmosphere.*—This is registered by the oscillations of a barometer suspended at one end of a bent scale beam I F, playing on a knife edge (fig. 800). The arm F supports a counterpoise; to the arm I is suspended the barometer B, which is wider at the top than at the bottom. A wooden flange, or floater Q, fixed to the lower part of the tube, plunges in a bath of mercury, so that the buoyancy of the liquid counterbalances part of the weight of the barometer. Owing to the large diameter of the barometric chamber, a very slight variation of level in this chamber makes the tube oscillate and with it the scale beam I F. To the axis of this is fixed a triangle  $ghk$ , jointed to a horizontal rod, which in turn is connected with a guide rod  $z$ . In the middle of this rod is a pencil which sharing in the oscillations of the triangle  $ghk$  traces the curve H of pressure. A bent lever at the bottom of the barometer tube keeps this in a vertical position.

*Rainfall.*—This is registered between the direction of the winds and the curve H, by a pencil at the end of a rod  $u$ , which is worked by an electro-magnet  $e$ . On the roof is a funnel which collects the rain, and a long tube leads the water to a small water balance, with the cups placed near the meteorograph (fig. 803). To the axis of the scale beam one pole of the battery is connected; the left cup being full, tips up and a contact  $a$  closes the current, which passes then to one of the binding screws C, and hence to the

electro-magnet  $e$ . Then the right cup being in turn full, tips in the opposite direction, and the contact  $b$  now transmits the current to the electro-magnet. Thus, at each oscillation this latter attracts its armature, and with it the rod  $a$ , which makes a mark by means of a pencil at the end. If the rain is abundant the oscillations of the beam are rapid, and the marks being very close together give a deep shade; if on the contrary the oscillations are slow, the marks are at a greater distance and give a light shade. When the rain ceases the oscillations cease also and the pencil makes no mark.

To complete this description of the first face of the meteorograph:  $s$  is the alarm bell of the clockwork,  $O O$ , a cord supporting a weight which moves the works of the hour hand.  $L Z$  is a second cord that supports the weight which works the alarm; the wheel  $a$ , placed below the clockwork, winds up the sheet  $AD$ , when it is at the bottom of its course.



Fig. 803.

The second sheet, fig. 804, gives the barometric height and the rain-fall like the first, but on a larger scale, since the motion of the sheet is five times as rapid. Its principal function is that of registering the moisture of the air. This is effected by means of the *psychrometer* (fig. 805).  $T$  and  $T'$  are two thermometers fixed on two plates. The muslin which covers the second is kept continually moist by water dropping on it. In each of the bulbs are fused two platinum wires; the stems of the thermometers are open at the top, and in them are immersed two platinum wires  $m$  and  $n$ , suspended to a metal frame movable on four pulleys supported by a fixed piece  $B$ . The frame  $A$  in contact with the current of the battery is suspended to a steel wire  $L$ , which passes over a pulley to the meteorograph (fig. 804). Here is a long triangular lever  $W$ , which supports a small wheel to which is fixed the wire  $L$ . The lever  $W$ , which turns about an axis  $f$ , is moved by a rod  $a$ , by means of an excentric which the clock works every quarter of an hour. At each oscillation the lever  $W$  transmits its movement to a small chariot, on which is an electro-magnet  $x$ , and at the same time to the steel wire  $L$ , which supports the frame  $A$  (fig. 805). The chariot moved towards the left by the rotation of the excentric, lets the frame sink. The moment the first platinum wire reaches the mercurial column of the dry bulb thermometer which is the highest, the current is closed, and passes into the electro-magnet of the chariot. An armature at once causes a pencil to mark a point on the sheet which is the beginning of a line representing the path of the dry bulb thermometer. As the frame continues to descend, the second platinum wire touches the mercury of the wet bulb, and closes a current in a relay  $M$ , which opens the circuit of the electro-magnet  $x$ . The pencil is then detached; then returning upon itself the chariot reproduces the closing and opening of the circuit in the opposite direction, the pencil makes another mark, which is the end of the line. There are thus formed two series of dots arranged in two curves, one of which represents the path of the dry, and the other the path of the wet bulb. The horizontal distance

of the two points of these curves is proportional to the difference  $t - t_1$ , of the temperatures indicated at the same moment by the thermometers (205).

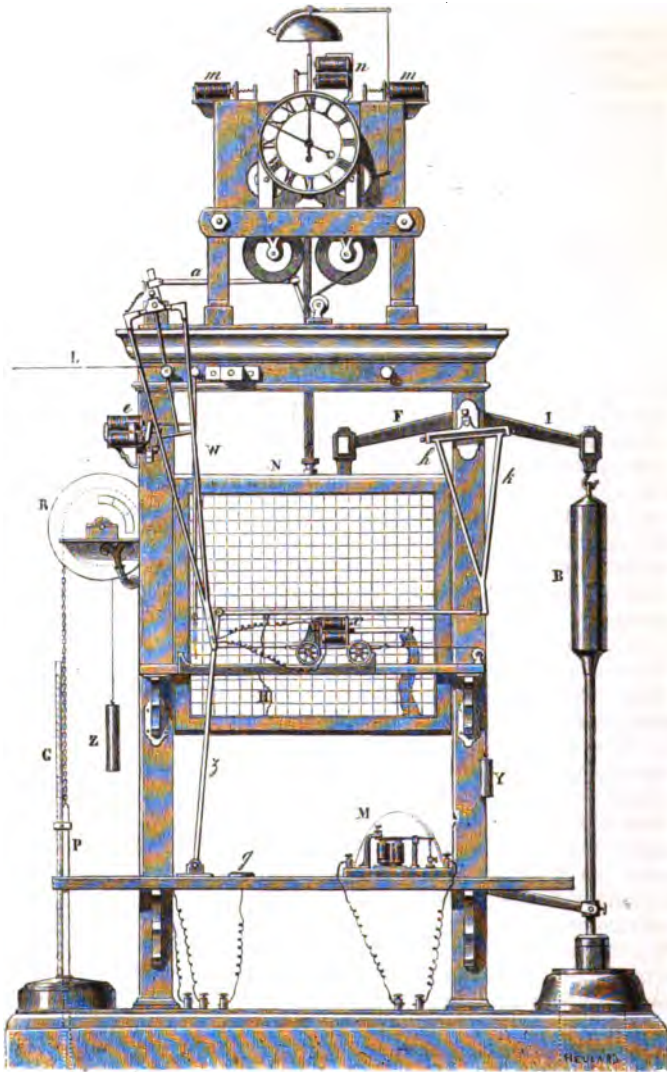

Fig. 804.

*Quantity of rain.*—The quantity of rain which falls in a given time is registered on a disc of paper on a pulley R. On the groove of this is

coiled a chain to which is suspended a brass tube P. This is fixed at the bottom to a float which plunges in a reservoir placed in the base of the meteorograph. On passing out of the water balance (fig. 804) the water passes into this reservoir, and as its section is one fourth that of the funnel, the height of water which falls is quadrupled; it is measured on a scale G, divided into millimetres.

As the float rises, a weight Z moves the pulley in the contrary direction, and its rotation is proportional to the height of water which has fallen. A pencil moves at the same time from the centre to the circumference of the paper disc with a velocity of 5 mm. in 24 hours; hence the quantity of rain which falls every day is noted on a different place on the paper disc.

#### Aerial Meteors.

##### 927. Direction and velocity of winds.—

*Winds* are currents moving in the atmosphere with variable directions and velocities. There are eight principal directions in which they blow—*north, north-east, east, south-east, south, south-west, west, and north-west*. Mariners further divide each of the distances between these eight directions into four others, making in all 32 directions, which are called *points* or *rhumbs*. A figure of 32 rhumbs on a circle, in the form of a star, is known as the *mariner's card*.

Velocity is determined by means of the *anemometer* (fig. 802), a small vane with fans, which the wind turns; the velocity is deduced from the number of turns made in a given time. In our climate the mean velocity is from 18 to 20 feet in a second. With a velocity of less than 18 inches in a second no movement is perceptible and smoke ascends straight; with a velocity between  $1\frac{1}{2}$  and 2 feet per second the wind is perceptible and moves a pennant; from 13 to 22 feet it is moderate, it stretches a flag and moves the leaves of trees; with from 23 to 36 feet velocity it is fresh and moves the branches of trees; with 36 to 56 feet it is strong and moves the larger branches and the smaller stems; with a velocity of 56 to 90 feet it is a storm and entire trees are moved; and from 90 to 120 it is a hurricane.

To measure the pressure of the wind a plate is used which by means of a vane is always kept in a direction opposite that of the wind. Behind the plate are one or more springs which are the more pressed the greater is the pressure of the wind against the plate. Knowing the distance through which the plate is pressed we can calculate the pressure which the wind exerts on the plate in question.

With some degree of approximation and for low velocities the pressure may be taken as proportional to the square of the velocity. Thus if the pressure on the square foot is 0.005 pound with a velocity of 1.5 feet in a

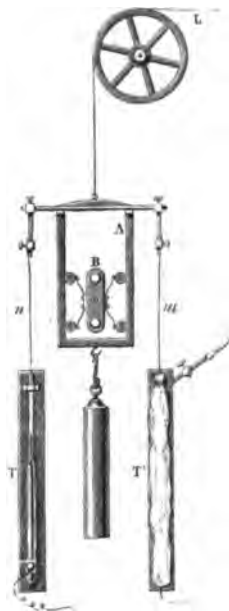

Fig. 805.



second, it is 0·02 pounds with a velocity of 30 feet, and 0·123 with a velocity of 7·33 feet.

928. **Causes of winds.**—Winds are produced by a disturbance of the equilibrium in some part of the atmosphere; a disturbance always resulting from a difference in temperature between adjacent countries. Thus, if the temperature of a certain extent of ground becomes higher, the air in contact with it becomes heated, it expands and rises towards the higher regions of the atmosphere; whence it flows, producing winds which blow from hot to cold countries. But at the same time the equilibrium is destroyed at the surface of the earth, for the barometric pressure on the colder adjacent parts is greater than on that which has been heated, and hence a current will be produced with a velocity dependent on the difference between these pressures; thus two distinct winds will be produced, an upper one setting *outwards* from the heated region, and a lower one setting *inwards* towards it.

929. **Regular, periodical, and variable winds.**—According to the more or less constant directions in which winds blow, they may be classed as regular, periodical, and variable winds.

i. *Regular winds* are those which blow all the year through in a virtually constant direction. These winds, which are also known as the *trade winds*, are uninterruptedly observed far from the land in equatorial regions, blowing from the north-east to the south-west in the northern hemisphere, and from the south-east to the north-west in the southern hemisphere. They prevail on the two sides of the equator as far as 30° of latitude, and they blow in the same direction as the apparent motion of the sun—that is, from east to west.

The air above the equator being gradually heated, rises as the sun passes round from east to west, and its place is supplied by the colder air from the north or south. The direction of the wind, however, is modified by this fact, that the velocity which this colder air has derived from the rotation of the earth—namely, the velocity of the surface of the earth at the point from which it started—is less than the velocity of the surface of the earth at the point at which it has now arrived; hence the currents acquire, in reference to the equator, the constant direction which constitutes the trade winds.

ii. *Periodical winds* are those which blow regularly in the same direction at the same seasons, and at the same hours of the day: the monsoon, simoom, and the land and sea breeze are examples of this class. The name *monsoon* is given to winds which blow for six months in one direction and for six months in another. They are principally observed in the Red Sea and in the Arabian Gulf, in the Bay of Bengal and in the Chinese Sea. These winds blow towards the continents in summer, and in a contrary direction in winter. The *simoom* is a hot wind which blows over the deserts of Asia and Africa, and which is characterised by its high temperature and by the sands which it raises in the atmosphere and carries with it. During the prevalence of this wind the air is darkened, the skin feels dry, the respiration is accelerated, and a burning thirst is experienced.

This wind is known under the name of *sirocco* in Italy and Algiers, where it blows from the great desert of Sahara. In Egypt, where it prevails from

the end of April to June, it is called *kamsin*. The natives of Africa, in order to protect themselves from the effects of the too rapid perspiration occasioned by this wind, cover themselves with fatty substances.

The *land* and *sea breeze* is a wind which blows on the sea coast, during the day from the sea towards the land, and during the night from the land to the sea. For during the day the land becomes more heated than the sea, in consequence of its lower specific heat and greater conductivity, and hence as the superincumbent air becomes more heated than that upon the sea, it ascends and is replaced by a current of colder and denser air flowing from the sea towards the land. During the night the land cools more rapidly than the sea, and hence the same phenomenon is produced in a contrary direction. The sea breeze commences after sunrise, increases to three o'clock in the afternoon, decreases towards evening, and is changed into a land breeze after sunset. These winds are only perceived at a slight distance from the shores. They are regular in the tropics, but less so in our climates; and traces of them are seen as far as the coasts of Greenland. The proximity of mountains also gives rise to periodical daily breezes.

iii. *Variable winds* are those which blow sometimes in one direction and sometimes in another, alternately, without being subject to any law. In mean latitudes the direction of the winds is very variable; towards the poles this irregularity increases, and under the arctic zone the winds frequently blow from several points of the horizon at once. On the other hand, in approaching the torrid zone, they become more regular. The south-west wind prevails in the north of France, in England, and in Germany; in the south of France the direction inclines towards the north, and in Spain and Italy the north wind predominates.

930. **Law of the rotation of winds.**—Spite of the great irregularity which characterises the direction of the winds in our latitude, it has been ascertained that the wind has a preponderating tendency to veer round according to the sun's motion—that is, to pass from north, through north-east, east, south-east to south, and so on round in the same direction from west to north; that it often makes a complete circuit in that direction, or more than one in succession, occupying many days in doing so, but that it rarely veers, and very rarely or never makes a complete circuit in the opposite direction. This course of the winds is most regularly observed in winter. According to Leverrier, the displacement of the north-east by the south-west wind arises from the occurrence of a whirlwind formed upon the Gulf-stream.

For a station in south latitude a contrary law of rotation prevails.

This law, though more or less suspected for a long time, was first formally enunciated and explained by Dove, and is known as *Dove's law of rotation of winds*.

931. **Fogs and mists.**—When aqueous vapours rising from a vessel of boiling water diffuse in the colder air, they are condensed; a sort of cloud is formed which consists of a number of small hollow vesicles of water, which remain suspended in the air. These are usually spoken of as vapours, yet they are not so, at any rate not in the physical sense of the word; for in reality they are partially condensed vapours.

When this condensation of aqueous vapours is not occasioned by contact

with cold solid bodies, but takes place throughout large spaces of the atmosphere, they constitute *fogs* or *mists*, which, in fact, are nothing more than the appearance seen over a vessel of hot water.

A chief cause of fogs consists in the moist soil being at a higher temperature than the air. The vapours which then ascend condense and become visible. In all cases, however, the air must have reached its point of saturation before condensation takes place. Fogs may also be produced when a current of hot and moist air passes over a river at a lower temperature than its own, for then the air being cooled, as soon as it is saturated, the excess of vapour present is condensed.

The distinction between mists and fogs is one of degree rather than of kind. A fog is a very thick mist.

932. **Clouds.**—*Clouds* are masses of vapour, condensed into little drops or vesicles of extreme minuteness, like fogs. There is no difference of kind



Fig. 806.

between fogs and clouds. Fogs are clouds resting on the ground. To a person enveloped in it, a cloud on a mountain appears like a fog. They always result from the condensation of vapours which rise from the earth. According to their appearance, they have been divided by Howard into four principal kinds: the *nimbus*, the *stratus*, the *cumulus*, and the *cirrus*. These four kinds are represented in fig. 806, and are designated respectively by one, two, three, and four birds on the wing.

The *cirrus* consists of small whitish clouds, which have a fibrous or wispy appearance, and occupy the highest regions of the atmosphere. The name of *mares' tails*, by which they are generally known, well describes their appearance. From the low temperature of the spaces which they occupy,

it is more than probable that cirrus clouds consist of frozen particles ; and hence it is that haloes, coronæ, and other optical appearances, produced by refraction and reflection from ice crystals, appear almost always in these clouds and their derivatives. Their appearance often precedes a change of weather.

The *cumulus* are rounded spherical forms which look like mountains piled one on the other. They are more frequent in summer than in winter and after being formed in the morning, they generally disappear towards evening. If, on the contrary, they become more numerous, and especially if surmounted by cirrus clouds, rain or storms may be expected.

*Stratus* clouds consist of very large and continuous horizontal sheets, which chiefly form at sunset, and disappear at sunrise. They are frequent in autumn and unusual in spring time, and are lower than the preceding.

The *nimbus*, or rain clouds, which are sometimes classed as one of the fundamental varieties, are properly a combination of the three preceding kinds. They affect no particular form, and are solely distinguished by a uniform grey tint, and by fringed edges. They are indicated on the right of the figure by the presence of one bird.

The fundamental forms pass into one another in the most varied manner ; Howard has classed these traditional forms as *cirro-cumulus*, *cirro-stratus*, and *cumulo-stratus*, and it is often very difficult to tell from the appearance of a cloud, which type it most resembles. The cirro-cumulus is most characteristically known as a 'mackerel sky ;' it consists of small roundish masses, disposed with more or less irregularity and connection. It is frequent in summer, and attendant on warm and dry weather. *Cirro-stratus* appears to result from the subsidence of the fibres of cirrus to a horizontal position, at the same time approaching laterally. The form and relative position when seen in the distance frequently give the idea of shoals of fish. The tendency of *cumulo-stratus* is to spread, settle down into the *nimbus*, and finally fall as rain.

The height of clouds varies greatly ; in the mean it is from 1,300 to 1,500 yards in winter, and from 3,300 to 4,400 yards in summer. But they often exist at greater heights ; Gay-Lussac, in his balloon ascent, at a height of 7,650 yards, observed cirrus-clouds above him, which appeared to be at a considerable height. In Ethiopia, M. d'Abbadie observed storm clouds whose height was only 230 yards above the ground.

In order to explain the suspension of clouds in the atmosphere, Halley first proposed the hypothesis of vesicular vapours. He supposed that clouds are formed of an infinity of extremely minute vesicles, hollow, like soap bubbles filled with air, which are hotter than the surrounding air : so that these vesicles float in the air like so many small balloons. This theory, which was first propounded by Saussure, has at present many opponents. These latter assume that clouds and fogs consist of extremely minute droplets of water which are retained in the atmosphere by the ascensional force of currents of hot air, just as light powders are raised by the wind. Ordinarily, clouds do not appear to descend, but this absence of downward motion is only apparent. In fact, clouds do usually fall slowly, but then the lower part is continually dissipated on coming in contact with the lower and more heated layers ; at the same time the upper part is always increasing from the condensation of

new vapours ; so that from these two actions clouds appear to retain the same height.

933. **Formation of clouds.**—Many causes may concur in the formation of clouds. The usual cause of the formation of a cloud is the ascent, into higher regions of the atmosphere, of air laden with aqueous vapour ; it thereby expands, being under diminished pressure, and in consequence of this expansion it is cooled, and this cooling produces a condensation of vapour. Hence it is that high mountains, stopping the currents of air and forcing them to rise, are an abundant source of rain. If the air is quite dry its temperature would be one degree lower for every 301 metres. The case is different with moist air ; for when the air has ascended so high that its temperature has fallen to the dew-point, aqueous vapour is condensed, and in consequence of this heat is liberated ; when the dew-point is thus attained, and the air is saturated, the cooling due to the ascent and expansion of air is counteracted by this liberation of latent heat, so that the diminution of temperature with the height is considerably slower in the case of moist than of dry air.

The following calculation will give us the quantity of water separated in a given case. Suppose air at a temperature of  $20^{\circ}$  to be saturated with aqueous vapour at that temperature ; the pressure of the vapour will be 17.4 mm., and the weight contained in one cubic metre of air 17.1 grammes.

If the air has risen to a height of 3,500 metres, it has come under a pressure which is only  $\frac{2}{3}$  of what it was ; its temperature is  $4^{\circ}$  and its volume about  $1\frac{1}{2}$  times what it originally was. As it remains saturated the pressure will be 6.1 mm., and the quantity of vapour will be 6.4 grammes in a cubic metre, that is to say,  $6.4 \times 1\frac{1}{2} = 9.6$  grammes in the whole mass of what was originally a cubic metre. The pressure of aqueous vapour has sunk during the ascent from 17.4 mm. to 6.1 mm. and its weight 17.1 grammes to 9.6 grammes, that is a weight of 7.5 grammes has been deposited, for that mass of air which at the sea level occupied a space of one cubic metre. These 7.5 grammes are in the form of the small droplets which constitute fogs or clouds.

If the mass of air had risen to a height of 8,500 metres, where the pressure is only one-third that on the sea-level, the temperature is  $-28^{\circ}$ , and the space it occupies three times as great as at first. The pressure of aqueous vapour is 0.5 mm., and its weight 0.6 grammes in a cubic metre. Hence of the entire quantity of aqueous vapour originally present there are now only 1.8 grammes left, and the remainder 15.3 grammes would be separated as water or ice. A similar calculation will show that at a height of 4,200 metres where the temperature is zero and the pressure  $\frac{2}{3}$ , the quantity of water present in the original cubic metre, is only 8.2 grammes, the rest being deposited.

Thus, a mass of air which, at the sea-level, occupies a space of a cubic metre, and is saturated with aqueous vapour at  $20^{\circ}$ , and then contains 17.1 grammes, will only contain 9.6 grammes at a height of 3,500 metres, 8.2 grammes at 4,200 metres, and 1.8 grammes at 8,500 metres. Hence, while a mass of air rises from the sea-level to a height of 4,200 ft., 8.9 grammes of aqueous vapour are separated as cloud vesicles ; at 8,500 metres or about double the height, 6.4 grammes are separated in the form of ice.

A hot, moist current of air mixing with a colder current, undergoes a cooling, which brings about a condensation of the vapour. Thus the hot and

moist winds of the south and south-west, mixing with the colder air of our latitudes, give rain. The winds of the north and north-east tend also, in mixing with our atmosphere, to condense the vapours; but as these winds, owing to their low temperature, are very dry, the mixture rarely attains saturation, and generally gives no rain.

The formation of clouds in this way is thus explained by Hutton. The tension of aqueous vapour, and therewith the quantity present in a given space when saturated, diminishes according to a geometric progression, while the temperature falls in arithmetical progression, and therefore the elasticity of the vapour present at any time is reduced by a fall of temperature more rapidly than in direct proportion to the fall. Hence if a current of warm air, saturated with aqueous vapour, meet a current of cold air also saturated, the air acquires the mean temperature of the two, but can only retain a portion of the vapour in the invisible condition, and a cloud or mist is formed. Thus suppose a cubic metre of air at  $10^{\circ}$  C. mixes with a cubic metre of air at  $20^{\circ}$  C., and that they are respectively saturated with aqueous vapour. By formula (389) it is easily calculated that the weight of water contained in the cubic metre of air at  $10^{\circ}$  C. is 9.397 grammes, and in that at  $20^{\circ}$  C. is 17.632 grammes, or 27.029 grammes in all. When mixed they produce two cubic metres of air at  $15^{\circ}$  C.; but as the weight of water required to saturate this is only  $2 \times 12.8 = 25.6$  grammes, the excess, 1.429 grammes, will be deposited in the form of mist or clouds.

**934. Rain.**—When by the constant condensation of aqueous vapour the individual vapour vesicles become larger and heavier, and when finally individual vesicles unite, they form regular drops which fall as *rain*.

The quantity of rain which falls annually in any given place, or the annual rainfall, is measured by means of a *rain gauge* or *pluviometer*. Ordinarily it consists of a cylindrical vessel M (figs. 807 and 808), closed at the top by a



Fig. 807.



Fig. 808.

funnel-shaped lid, in which there is a very small hole, through which the rain falls. At the bottom of the vessel is a glass tube, A, in which the water rises to the same height as inside the rain gauge, and is measured by a scale on the side, as shown in the figures.

The apparatus being placed in an exposed situation, if at the end of a month the height of water in the tube is two inches for example, it shows that the water has attained this height in the vessel; and, consequently, that a

layer of two inches in depth expresses the quantity of rain which this extent of surface has received.

It has been noticed that the quantity of rain indicated by the rain gauge is greater as this instrument is nearer the ground. This has been ascribed to the fact that the rain-drops, which are generally colder than the layers of air which they traverse, condense the vapour in these layers, and, therefore, constantly increase in volume. Hence more rain falls on the surface of the ground than at a certain height. But it has been objected that the excess of the quantity of rain which falls, over that at a certain height, is six or seven times that which could arise from condensation, even during the whole course of the rain-drops from the clouds to the earth. The difference must, therefore, be ascribed to purely local causes, and it is now assumed that the difference arises from eddies produced in the air about the rain gauge, which are more perceptible as it is higher above the ground; as these eddies disperse the drops which would otherwise fall into the instrument, they diminish the quantity of water which it receives.

In any case it is clear that if rain-drops traverse moist air, they will, from their temperature, condense aqueous vapour and increase in volume. If, on the contrary, they traverse dry air, the drops tend to vaporise, and less rain falls than at a certain height; it might even happen that the rain did not reach the earth.

Many local circumstances may affect the quantity of rain which falls in different countries; but, other things being equal, most rain falls in hot climates, for there the vaporisation is most abundant. The rainfall decreases, in fact, from the equator to the poles. At London it is 23·5 inches; at Bordeaux it is 25·8; at Madeira it is 27·7; at Havannah it is 91·2, and at St. Domingo it is 107·6. The quantity varies with the season; in Paris, in winter, it is 4·2 inches; in spring 6·9; in summer 6·3, and in autumn 4·8 inches. The heaviest annual rainfall at any place on the globe is on the Khasia Hills in Bengal, where it is 600 inches; of which 500 inches fall in seven months.

The driest recorded place in England is Lincoln, where the mean rainfall is 20 inches, and the wettest is Styre, at the head of Borrowdale in Cumberland, where it amounts to 165 inches.

An inch of rain on a square yard of surface expresses a fall of 46·74 pounds, or 4·67 gallons. On an acre it corresponds to 22,622 gallons, or 100·9935 tons. 100 tons per inch per acre is a ready way of remembering this.

935. **Waterspouts.**—These are masses of vapour suspended in the lower layers of the atmosphere which they traverse, and endowed with a gyratory motion rapid enough to uproot trees, upset houses, and break and destroy everything with which they come in contact.

These meteors, which are generally accompanied by hail and rain, often emit lightning and thunder, producing the sound of carriages rolling over a stony road. Many of them have no gyratory motion, and about a quarter of those observed are produced in a calm atmosphere.

When they take place on the sea they present a curious phenomenon. The water is disturbed, and rises in the form of a cone, while the clouds are depressed in the form of an inverted cone; the two cones then unite and form a continuous column from the sea to the clouds (fig. 809), which are

called *waterspouts*. Even, however, on the high seas the water of these waterspouts is never salt, proving that they are formed of condensed vapours, and not of sea water raised by aspiration.

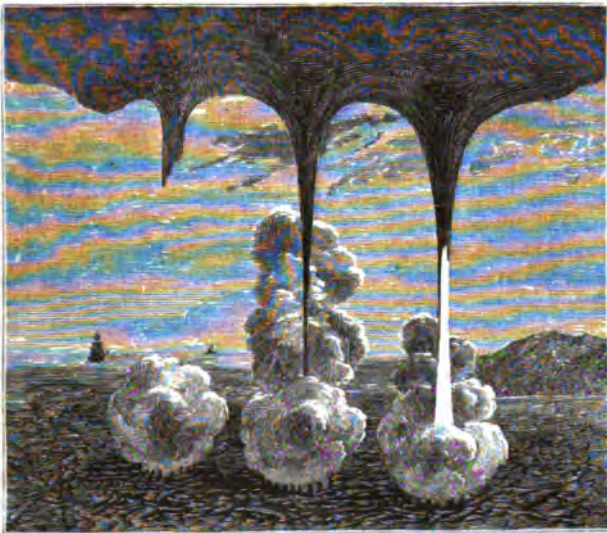

Fig. 809.

The origin of these is not known. Kæmtz assumes that they are due principally to two opposite winds which pass by the side of each other, or to a very high wind which prevails in the higher regions of the atmosphere. Peltier and many others ascribe to them an electric origin.

936. **Influence of aqueous vapour on climate.**—Tyndall has applied the property possessed by aqueous vapour of powerfully absorbing and radiating heat to the explanation of some obscure points in meteorological science, and there can be no doubt that the knowledge of it will gradually lead to a clearer understanding of many inexplicable and apparently capricious meteorological phenomena.

Tyndall has established the fact, that in a tube 4 feet long the atmospheric vapour on a day of average dryness absorbs 10 per cent. of obscure heat. With the earth warmed by the sun, as a source, there can be no doubt that at the very least 10 per cent. of its heat is intercepted within 10 feet of the surface. If aqueous vapour be compared atom for atom with air, its power of absorption and radiation is more than 16,000 times that possessed by air. Such facts as these are sufficient to show the importance of the small quantity of this vapour that exists in our atmosphere.

The *radiative* power of aqueous vapour may be the main cause of the torrential rains that occur in the tropics, and also of the formation of cumuli clouds in our own latitudes. The same property probably causes the



descent of a very fine rain, called *sérein*, which has more the characteristics of falling dew, as it appears a short time after sunset, when the sky is clear; its production has therefore been attributed to the cold, resulting from the radiation of the air. It is not the air, however, but the aqueous vapour in the air, which by its own radiation chills itself, so that it condenses into *sérein*.

The *absorbent* power of aqueous vapour is of even greater importance. Whenever the air is dry, terrestrial radiation at night is so rapid as to cause intense cold. Thus, in the central parts of Asia, Africa, and Australia, the daily range of the thermometer is enormous; in the interior of the last continent a difference in temperature of no less than  $40^{\circ}$  C. has been recorded within 24 hours. In India, and even in the Sahara, owing to the copious radiation, ice has been formed at night. But the heat which aqueous vapour absorbs most largely is of the kind emitted from sources of low temperature; it is to a large extent transparent to the heat emitted from the sun, whilst it is almost opaque to the heat radiated from the earth. Consequently, the solar rays penetrate our atmosphere with a loss, as estimated by Pouillet, of only 25 per cent., when directed vertically downwards, but after warming the earth they cannot retrace the atmosphere. Through thus preventing the escape of terrestrial heat, the aqueous vapour in the air moderates the extreme chilling which is due to the unchecked radiation from the earth, and raises the temperature of that region over which it is spread. In Tyndall's words:—'Aqueous vapour is a blanket more necessary to the vegetable life of England than clothing is to man. Remove for a single summer night the aqueous vapour from the air which overspreads this country, and every plant capable of being destroyed by a freezing temperature would perish. The warmth of our fields and gardens would pour itself unrequited into space, and the sun would rise upon an island held fast in the iron grip of frost.'

937. **Tyndall's researches.**—Tyndall found that by the action of solar and of the electric light on vapours under a great degree of attenuation, they are decomposed. This new reaction not only puts a powerful agent of chemical decomposition into the hands of chemists, but it has led Tyndall to important conclusions regarding the origin of the blue colour of the sky, and the polarisation of daylight.

He used a glass tube with glass ends, such as he had employed for his researches on radiant heat. This could be exhausted and then filled with air charged with the vapours of volatile liquids, by allowing the air to pass through small Wolff bottles containing them. By mixing with different proportions of pure air the air charged with vapour, and by varying the degree of exhaustion, it was possible to have a vapour under any degree of attenuation. It was also possible to fill the tube with the vapour of a liquid alone.

The tube having been filled with air charged with vapours of nitrite of amyle, a somewhat convergent beam from the electric lamp was passed into the tube. For a moment the tube appeared optically empty, but suddenly a shower of liquid spherules was precipitated on the path of the beam forming a luminous white cloud. The nature of the substance thus precipitated was not specially investigated.

This effect was not due to any chemical action between the vapour and

the air, for when either dry oxygen or dry hydrogen was used instead of air, or when the vapour was admitted alone, the effect was substantially the same. Nor was it due to any heating effect, for the beam had been previously sifted by passing through a solution of alum, and through the thick glass of the lens. The unsifted beam produced the same effect; the obscure calorific rays did not seem to interfere with the result.

The sun's light also affects the decomposition of the nitrite of amyle vapour; and this decomposition was found to be mainly due to the more refrangible rays.

When the electric light, before entering the experimental tube, was made to pass through a layer of the liquid nitrite of amyle an eighth of an inch in thickness, the luminous effect was not appreciably diminished, but the chemical action was almost entirely stopped. Thus that special constituent of the luminous radiation which effects the decomposition of the vapour is absorbed by the liquid. The liquid nitrite of amyle is probably decomposed by light; but its decomposition, if it take place at all, is far less rapid and distinct than that of the vapour. The circumstance that the absorption is the same whether the nitrite is in the liquid or in the vaporous state, is considered by Tyndall as a proof that the absorption is not the act of the molecule as a whole, but that it is atomic, that is, that it is to the atoms that the peculiar rate of vibration is transferred, which brings about the decomposition of the body.

The vapours of a number of other substances were examined, such, for example, as benzole, iodide of allyle, bisulphide of carbon. By varying the nature of the vapour, the shape of a cloud could be greatly varied, and in many cases presented the most fantastic and beautiful forms.

It was also found that a vapour which when alone resists the action of light, may, by being associated with another gas or vapour, exhibit a vigorous or even violent action. Thus, when the tube was filled with atmospheric air, mixed with nitrite of butyle vapour, the electric light produced very little effect. But with half an atmosphere of this mixture, and half an atmosphere of air which had passed through hydrochloric acid, the action of the light was almost instantaneous. In another case mixed air and nitrite of butyle vapour were passed into the tube so as to depress the barometer the  $\frac{1}{10}$ th of an inch; that is, the mixed air and vapour were under a pressure of  $\frac{1}{300}$ th of an atmosphere. Air passed through solution of hydrochloric acid was introduced until the pressure was 3 inches. The condensed beam passed through for some time without change, but afterwards a superbly blue cloud was formed.

In cases where the vapours are under a sufficient degree of attenuation, whatever otherwise be their nature, the visible action commences with the formation of a *blue cloud*. The term cloud, however, must not be understood in its ordinary sense; the blue cloud is invisible in ordinary daylight, and to be seen must be surrounded by darkness, *it alone* being illuminated by a powerful beam of light. The blue cloud differs in many important particulars from the finest ordinary clouds, and may be considered to occupy an intermediate position between these clouds and true cloudless vapour.

By graduating the quantity of vapour, the precipitation may be obtained

of any required degree of fineness : forming either particles distinguishable by the naked eye, or particles beyond the reach of the highest microscopic power.

The case is similar to that of carbonic acid gas, which, diffused in the atmosphere, resists the decomposing action of solar light, but, when in contiguity with the chlorophyle in the leaves of plants, is decomposed.

When the blue cloud produced in these experiments was examined by any polarising arrangement, the light emitted laterally from the beam—that is, in a direction at right angles to its axis—was found to be perfectly polarised. This phenomenon was observed in its greatest perfection the more perfect the blue of the sky. It is produced by any particles, provided they are sufficiently fine.

This is quite-analogous to the light of the blue sky. When this is examined by a Nicol's prism, or any other analyser, it is found that the light, emitted at right angles to the path of the sun's rays, is polarised.

These two phenomena, the firmamental blue, and the polarisation of the sky light, which have long been the enigmas of meteorologists, find their definite solutions in these experiments. We have only to assume the existence in the higher regions of the atmosphere of excessively fine particles of water ; for particles of any kind produce this effect. It is not difficult to conceive the existence of such particles in the higher regions, even on a hot summer's day. For the vapour must there be in a state of extreme attenuation ; and inasmuch as the oxygen and nitrogen of the atmosphere behave like a vacuum to radiant heat, the extremely attenuated particles of aqueous vapour are practically in contact with the absolute cold of space.

‘ Suppose the atmosphere surrounded by an envelope impervious to light, but with an aperture on the sunward side, through which a parallel beam of solar light could enter and traverse the atmosphere. Surrounded on all sides by air not directly illuminated, the track of such a beam would resemble that of the parallel beam of the electric light through an incipient cloud. The sunbeam would be blue, and it would discharge light laterally in the same condition as that discharged by the incipient cloud. The azure revealed by such a beam would be to all intents and purposes a blue cloud.’

938. **Dew. Hoar frost.**—*Dew* is merely aqueous vapour which has condensed on bodies during the night in the form of minute globules. It is occasioned by the chilling which bodies near the surface of the earth experience in consequence of nocturnal radiation. Their temperature having then sunk several degrees below that of the air, it frequently happens, especially in hot seasons, that this temperature is below that at which the atmosphere is saturated. The layer of air which is immediately in contact with the chilled bodies, and which has virtually the same temperature, then deposits a portion of the vapour which it contains, just as when a bottle of cold water is brought into a warm room, it becomes covered with moisture, owing to the condensation of aqueous vapour upon it.

According to this theory, which was first propounded by Dr. Wells, all causes which promote the cooling of bodies increase the quantity of dew. These causes are the emissive power of bodies, the state of the sky, and the agitation of the air. Bodies which have a great radiating power more readily become cool, and therefore ought to condense more vapour. In fact,

there is generally no deposit of dew on metals, whose radiating power is very small, especially when they are polished ; while the ground, sand, glass, and plants, which have a great radiating power, become abundantly covered with dew.

The state of the sky also exercises a great influence on the formation of dew. If the sky is cloudless, the planetary spaces send to the earth an inappreciable quantity of heat, while the earth radiates very considerably, and therefore becoming very much chilled, there is an abundant deposit of dew. But if there are clouds, as their temperature is far higher than that of the planetary spaces, they radiate in turn towards the earth, and as bodies on the surface of the earth only experience a feeble chilling, no deposit of dew takes place.

Wind also influences the quantity of vapour deposited. If it is feeble, it increases it, inasmuch as it renews the air ; if it is strong, it diminishes it as it heats the bodies by contact, and thus does not allow the air time to become cooled. Finally, the deposit of dew is more abundant according as the air is moister, for then it is nearer its point of saturation.

*Hoar frost* and *rime* are nothing more than dew which has been deposited on bodies cooled below zero, and has therefore become frozen. The flocculent form which the small crystals present, of which rime is formed, shows that the vapours solidify directly without passing through the liquid state. Hoar frost, like dew, is formed on bodies which radiate most, such as the stalks and leaves of vegetables, and is chiefly deposited on the parts turned towards the sky.

939. **Snow. Sleet.**—*Snow* is water solidified in stellate crystals, variously modified, and floating in the atmosphere. These crystals arise from



Fig. 810.

the congelation of the minute vesicles which constitute the clouds, when the temperature of the latter is below zero. They are more regular when formed in a calm atmosphere. Their form may be investigated by collecting them on a black surface, and viewing them through a strong lens. The regularity, and at the same time variety, of their forms are truly beautiful. Fig. 810 shows some of the forms as seen through a microscope.

It snows most in countries near the poles, or which are high above the sea level. Towards the poles the earth is constantly covered with snow; the same is the case on high mountains, where there are perpetual snows, even in equatorial countries.

*Sleet* is also solidified water, and consists of small icy needles pressed together in a confused manner. Its formation is ascribed to the sudden congelation of the minute globules of the clouds in an agitated atmosphere.

940. **Hail.**—*Hail* is a mass of compact globules of ice of different sizes, which fall in the atmosphere. In our climate hail falls principally during spring and summer, and at the hottest times of the day; it rarely falls at night. The fall of hail is always preceded by a peculiar noise.

Hail is generally the precursor of storms, it rarely accompanies them, and follows them more rarely still. Hail falls from the size of small peas to that of an egg or an orange. The formation of hailstones has never been altogether satisfactorily accounted for; nor more especially their great size.

941. **Ice. Regelation.**—Ice is nothing more than an aggregate of snow crystals, such as are shown in fig. 810. The transparency of ice is due to the close contact of these crystals, which causes the individual particles to blend into an unbroken mass, and renders the substance *optically*, as well as mechanically, continuous. When large masses of ice slowly melt away, a crystalline form is sometimes seen by the gradual disintegration into rude hexagonal prisms: a similar structure is frequently met with, but in greater perfection, in the ice caves or glaciers of cold regions.

An experiment of Tyndall has more clearly revealed the beautiful structure of ice. When a piece of ice is cut parallel to its planes of freezing, and the radiation from any source of light, as the sun, a gas or oil flame, is permitted to pass through it, the disintegration of the substance proceeds in a remarkable way. By observing the plate of ice through a lens, numerous small crystals will be seen studing the interior of the block; as the heat continues these crystals expand, and finally assume the shape of six-rayed stars of exquisite beauty.

This is a kind of negative crystallisation, the crystals produced being composed of water; they owe their formation to the molecular disturbance caused by the absorption of heat from the source. Nothing is easier than to reproduce this phenomenon, if care be taken in cutting the ice. The planes of freezing can be found by noting the direction of the bubbles in ice, which are either sparsely arranged in striæ at right angles to the surface, or thickly collected in beds parallel to the surface of the water. A warm and smooth metal plate should be used to level and reduce the ice to a slab not exceeding half an inch in thickness.

A still more important property of ice remains to be noticed. Faraday discovered that when two pieces of melting ice are pressed together they freeze into one at their points of contact. This curious phenomenon is now known under the name of *regelation*. The cause of it has been the subject of much controversy, but the simplest explanation seems to be that given by its discoverer. The particles on the exterior of a block of ice are held by cohesion on one side only: when the temperature is at  $0^{\circ}$  C., these exterior particles being partly free are the first to pass into the liquid state, and a film

of water covers the solid. But the particles in the interior of the block are bounded on all sides by the solid ice, the force of cohesion is here a maximum, and hence the interior ice has no tendency to pass into a liquid, even when the whole mass is at  $0^{\circ}$ . If the block be now split in halves, a liquid film instantly covers the fractured surfaces, for the force of cohesion on the fractured surfaces has been lessened by the act. By placing the halves together, so that their original position shall be regained, the liquid films on the two fractured surfaces again become bounded by ice on both sides. The film being excessively thin, the force of cohesion is able to act across it; the consequence of this is, the liquid particles pass back into the solid state, and the block is reunited by *regelation*. Not only do ice and ice thus freeze together, but regelation also takes place between moist ice and any nonconducting solid body, as flannel or sawdust: a similar explanation to that just given has been applied here, substituting another solid for the ice on one side. It must be remarked, however, that many eminent philosophers dissent from the explanation here given.

Whatever may be the true cause of regelation, there can be no doubt that this interesting observation of Faraday's explains many natural phenomena. For example, the formation of a snowball depends on the regelation of the snow granules composing it, and as regelation cannot take place at temperatures below  $0^{\circ}$  C., for then both snow and ice are dry, it is only possible to make a coherent snowball when the snow is melting.

The snow bridges, also, which span wide chasms in the Alps and elsewhere, and over which men can walk in safety, owe their existence to the regelation of gradually accumulating particles of snow.

Bottomley has made a very instructive experiment which illustrates regelation. A block of ice is suspended on two supports and a fine piano wire with heavy weights at each end is laid across it. After some time the wire has slowly cut its way through, but the cut surfaces have reunited and excepting a few bubbles show no trace of the operation; the wire is below zero, as is proved by placing it in cold water, upon which some ice forms about it.

942. *Glaciers*.—Tyndall has applied this regelating property of ice to the explanation of the formation and motion of glaciers, of which the following is a brief description. In elevated regions, what is termed the *snow line* marks the boundary of eternal snow, for above this the heat of summer is unable to melt the winter's snow. By the heat of the sun and the consequent percolation of water melted from the surface, the lower portions of the snow field are raised to  $0^{\circ}$  C.; at the same time this part is closely pressed together by the weight of the snow above, regelation therefore sets in, converting the loose snow into a coherent mass.

By increasing pressure the intermingled air which renders snow opaque becomes ejected and transparent; ice then results. Its own gravity, and the pressure from behind, urge downwards the glacier which has thus been formed. In its descent from the mountain the glacier behaves in all respects like a river, passing through narrow gorges with comparative velocity, and then spreading out and moving slowly as its bed widens. Further, just as the central portions of a river move faster than the sides, so Forbes ascertained that the centre of a glacier moves quicker than its

margin, and from the same reason (the difference in the friction encountered) the surface moves more rapidly than the bottom. To explain these facts Forbes assumed ice to be a viscous body capable of flexion, and flowing like lava ; but as ice has not the properties of a viscous substance, the now generally accepted explanation of glacier motion is that supplied by the theory of regelation. According to this theory, the brittle ice of the glacier is crushed and broken in its passage through narrow channels, such as that of Trélaporte on Mont Blanc ; and then, as it emerges from the gorge which confined it, becomes reunited by virtue of regelation ; in this instance forming the well-known Mer de Glace. By numerous experiments Tyndall has established that regelation is adequate to furnish this explanation, and with complete success has artificially imitated, on a small scale, the moulding of glaciers by the crushing and subsequent regelation of ice.

#### LUMINOUS METEORS.

**943. Atmospheric electricity. Franklin's experiment.**—The most frequent luminous phenomena, and the most remarkable for their effects, are those produced by the free electricity in the atmosphere. The first physicists who observed the electric spark compared it to the gleam of lightning, and its crackling to the sound of thunder. But Franklin, by the aid of powerful electrical batteries, first established a complete parallel between lightning and electricity ; and he indicated, in a memoir published in 1749, the experiments necessary to attract electricity from the clouds by means of pointed rods. The experiment was tried by Dalibard in France ; and Franklin, pending the erection of a pointed rod on a spire in Philadelphia, had the happy idea of flying a kite, provided with a metallic point, which could reach the higher regions of the atmosphere. In June 1752, during stormy weather, he flew the kite in a field near Philadelphia. The kite was flown with ordinary pack-thread, at the end of which Franklin attached a key, and to the key a silk cord, in order to insulate the apparatus ; he then fixed the silk cord to a tree, and having presented his hand to the key, at first he obtained no spark. He was beginning to despair of success, when, rain having fallen, the cord became a good conductor, and a spark passed. Franklin, in his letters, describes his emotion on witnessing the success of the experiment as being so great that he could not refrain from tears.

Franklin, who had discovered the power of points (717), but who did not understand its explanation, imagined that the kite withdrew from the cloud its electricity ; it is, in fact, a simple case of induction, and depends on the inductive action which the thunder cloud exerts upon the kite and the cord.

**944. Apparatus to investigate the electricity of the atmosphere.**—The apparatus used to ascertain the presence of electricity in the atmosphere are : the electroscope, either with pith balls, straw, or gold leaf ; the apparatus first used by Dalibard, and which consisted of an insulated iron rod, 36 yards in height ; arrows discharged into the atmosphere, and even kites and captive balloons.

To observe the electricity in fine weather, when the quantity is generally small, an electrometer is used, as devised by Saussure for this kind of investigation. It is an electroscope similar to that already described, but the rod to which the gold leaves are fixed is surmounted by a conductor 2 feet in length, and terminating either in a knob or a point (fig. 811). To protect the apparatus against rain, it is covered with a metallic shield 4 inches in diameter. The glass case is square, instead of being round, and a divided scale on its inside face indicates the divergence of the gold leaves or of the straws. This electrometer only gives signs of atmospheric electricity as long as it is raised in the atmosphere, so that it is in layers of air of higher electrical potential than its own.

To ascertain the electricity of the atmosphere. Saussure also used a copper ball, which he projected vertically with his hand. This ball was fixed to one end of a metallic wire, the other end of which was attached to a ring, which could glide along the conductor of the electrometer. From the divergence of the straws, or of the gold leaves, the electrical condition of the air at the height which the ball attained could be determined. Becquerel, in experiments made on the St. Bernard, improved Saussure's apparatus, by substituting for the knob an arrow, which was projected into the atmosphere by means of a bow. A gilt silk thread, 88 yards long, was fixed with one end to the arrow, while the other end was attached to the stem of an electroscope. Peltier used a gold-leaf electroscope, at the top of which was a somewhat large copper globe. Provided with this instrument, the observer stations himself in a prominent position—it is then quite sufficient to raise the electroscope even a foot or so to obtain signs of electricity.



Fig. 811.

To observe the electricity of clouds, where the potential is very considerable, use is made of a long bar terminating in a point. This bar, which is insulated with care, is fixed to the summit of a building, and its lower end is connected with an electrometer, or even with electric chimes (fig. 593), which announce the presence of thunder clouds. As, however, the bar can then give dangerous shocks, a metallic ball must be placed near it, which is well connected with the ground, and which is nearer the bar than the observer himself; so that if a discharge should ensue, it will strike the ball and not the observer. Richmann, of St. Petersburg, was killed in an experiment of this kind, by a discharge which struck him on the forehead.

Sometimes also captive balloons or kites have been used, provided with a point, and connected by means of a gilt cord with an electrometer.

A good collector of atmospheric electricity consists of a fishing-rod with an insulated handle which projects from an upper window. At the top is a bit of lighted tinder held in a metallic forceps, the smoke of which,



being an excellent conductor, conveys the electricity of the air down a wire attached to the rod. A sponge moistened with alcohol, and set on fire, is also an excellent conductor.

A very convenient instrument for investigating atmospheric electricity has been introduced by Sir W. Thomson ; it consists of an insulated can of water placed on a table or on a window-sill on the *inside*. The water discharges through a zinc nozzle at the end of a narrow pipe which projects through the partially open window to a distance of two or three feet, with a head of water of about 10 inches, and a discharge so slow that there is no trouble in replenishing the can ; the atmospheric electricity is quickly collected and may be examined by connecting the can with any electrometer.

945. **Ordinary electricity of the atmosphere.**—By means of the different apparatus which have been described, it has been found that the presence of electricity in the atmosphere is not confined to stormy weather, but that the atmosphere always contains free electricity, usually positive, but sometimes negative. When the sky is cloudless, the electricity is always positive, but it varies in amount with the height of the locality, and with the time of day. The amount is greatest in the highest and most isolated places. No trace of positive electricity is found in houses, streets, and under trees ; in towns positive electricity is most perceptible in large open spaces, on quays, or on bridges. In all cases, positive electricity is only found at a certain height above the ground. On flat land, it only becomes perceptible at a height of 5 feet ; above that point it increases according to a law which is not made out, but which seems to depend on the hygrometric state of the air.

At sunrise the free positive electricity is feeble ; it increases up to 11 o'clock, according to the season, and then attains its first maximum. It then decreases rapidly until a little before sunset, and then increases till it reaches its second maximum, a few hours after sunset ; the remainder of the night the electricity decreases until sunrise. Thus the greatest amount of electricity is observed when the barometric pressure is greatest. These increasing and decreasing periods, which are observed all the year, are more perceptible when the sky is clearer, and the weather more settled. The positive electricity of fine weather is much stronger in winter than in summer.

When the sky is clouded, the electricity is sometimes positive and sometimes negative. It often happens that the electricity changes its sign several times in the course of the day, owing to the passage of an electrified cloud. During storms, and when it rains or snows, the atmosphere may be positively electrified one day, and negatively the next, and the number of the two sets of days are virtually equal.

From a long series of observations on the electricity of the atmosphere made in the early morning Dellmann found that the electricity increased with the density of the fog, but in a far more rapid ratio.

The electricity of the ground has been found by Peltier to be always negative, but to different extents, according to the hygrometric state and temperature of the air.

946. **Causes of the atmospheric electricity.**—Many hypotheses have been propounded to explain the origin of the atmospheric electricity. It

must be confessed, however, that our knowledge of the origin of atmospheric electricity is in a very unsatisfactory state.

Volta first showed that the evaporation of water produced electricity. Pouillet subsequently showed that no electricity is produced by the evaporation of distilled water; but if an alkali or a salt is dissolved, even in small quantity, that the vapour is positively and the solution is negatively electrified. The reverse is the case if the water contains acid. Hence it has been assumed that as the waters which exist on the surface of the earth and on the sea always contain salt dissolved, the vapours disengaged ought to be positively and the earth negatively electrified. The development of electricity by evaporation may be observed by heating strongly a platinum dish, adding to it a small quantity of liquid, and placing it on the upper plate of the condensing electroscope (fig. 611), taking care to connect the lower plate with the ground. When the water of the capsule is evaporated, the connexion with the ground is broken, and the upper plate raised. The gold leaves then diverge if the water contained salts, but remain quiescent if the water was pure.

Reasoning from such experiments, Pouillet has ascribed the development of electricity by evaporation to the separation of particles of water from the substances dissolved; but Reich and Riess have shown that the electricity disengaged during evaporation could be attributed to the friction which the particles of water carried away in the current of vapour exercise against the sides of the vessel, just as in Armstrong's electrical machine (735). By a recent series of experiments, Gaugain has arrived at the same result; and thinks it no longer allowable to ascribe the atmospheric electricity to any changes that take place during the tranquil evaporation of sea water.

In support of an hypothesis which considers the earth as an immense source of voltaic electricity due to chemical actions, Becquerel has recently published numerous experiments to show that when earth and water come in contact, electricity is always produced: the earth taking a considerable excess of positive or negative electricity, and the water a corresponding excess of the opposite electricity, according to the nature of the salts or other compounds which the water held dissolved. This is a general fact which, according to Becquerel, is liable to no exception.

Becquerel experimented with an ordinary multiplier, the wire of which was connected with two platinum plates immersed in the pieces of ground, or the water whose electrical condition he wished to investigate. He thus found that when two moist pieces of ground are connected, that which contained the strongest solution took an excess of positive electricity. He found that in the neighbourhood of a river, even at some distance, the land and objects placed on the surface possessed an excess of negative electricity, while the water and the aquatic plants which swam on the surface were charged with positive electricity. But according to the nature of the substances dissolved in the water, different effects were produced. As from Becquerel's experiments, the waters are sometimes positive and sometimes negative, and the earth in a contrary condition, it follows that water in evaporating must constantly send into the atmosphere an excess of positive or negative electricity, while the earth, by the vapours disengaged on its surface, allows an excess of the contrary electricity to escape. Now this excess of electricity ought necessarily to influence the distribution of the elec-

tricity in the atmosphere, and may serve to explain how it is that the clouds are sometimes positively and sometimes negatively electrified.

947. **Electricity of clouds.**—In general the clouds are all electrified, sometimes positively and sometimes negatively, and only differ in their greater or less tension. The formation of positive clouds is usually ascribed to the vapours which are disengaged from the ground, and condense in the higher regions. Negative clouds are supposed to result from fogs, which, by their contact with the ground, become charged with negative electricity, which they retain on rising into the atmosphere ; or that, separated from the ground by layers of moist air, they have been negatively electrified by induction from the positive clouds, which have repelled into the ground positive electricity.

948. **Lightning.**—This, as is well known, is the dazzling light emitted by the electric spark when it shoots from clouds charged with electricity. In the lower regions of the atmosphere the light is white, but in the higher regions, where the air is more rarefied, it takes a violet tint ; as does the spark of the electrical machine in a rarefied medium (763).

The flashes of lightning are sometimes several leagues in length ; they generally pass through the atmosphere in a zigzag direction : a phenomenon ascribed to the resistance offered by the air condensed by the passage of a strong discharge. The spark then diverges from a right line, and takes the direction of least resistance. In *vacuo* electricity passes in a straight line.

Several kinds of lightning flashes may be distinguished—1. the *zigzag* flashes which move with extreme velocity in the form of a line of fire with sharp outlines, and which entirely resemble the spark of an electrical machine ; 2. the *sheet* flashes which, instead of being linear, like the preceding, fill the entire horizon without having any distinct shape. This kind, which is most frequent, appears to be produced in the cloud itself, and to illuminate the mass. According to Kundt the number of sheet discharges are to the zigzag discharges as 11 : 6 ; and from spectrum observations it would appear that the former are brush discharges between clouds, while the latter are true electrical discharges between the clouds and the earth. Another kind is called *heat lightning*, because it illuminates the summer nights without the presence of any clouds above the horizon, and without producing any sound. The most probable of the many hypotheses which have been proposed to account for its origin, is that which supposes it to consist of ordinary lightning flashes which strike across the clouds at such distances that the rolling of thunder cannot reach the ear of the observer. There is further the very unusual phenomenon of *globe lightning*, or the flashes which appear in the form of globes of fire. These, which are sometimes visible for as much as ten seconds, descend from the clouds to the earth with such slowness that the eye can follow them. They often rebound on reaching the ground ; at other times they burst and explode with a noise like that of the report of many cannon.

The duration of the light of the first three kinds does not amount to a thousandth of a second, as was determined by Wheatstone by means of a rotating wheel, which was turned so rapidly that the spokes were invisible : on illuminating it by the lightning flash, its duration was so short that

whatever the velocity of rotation of the wheel, it appeared quite stationary; that is, its displacement is not perceptible during the time the lightning exists.

949. **Thunder.**—*Thunder* is the violent report which succeeds lightning in stormy weather. The lightning and the thunder are always simultaneous, but an interval of several seconds is always observed between these two phenomena, which arises from the fact that sound only travels at the rate of about 1,100 feet in a second (226); while the passage of light is almost instantaneous. Hence an observer will only hear the noise of thunder five or six seconds, for instance, after the lightning, according as the distance of the thunder-cloud is five or six times 1,100 feet. The noise of thunder arises from the disturbance which the electric discharge produces in the air, and which may be witnessed in Kinnersley's thermometer. Near the place where the lightning strikes, the sound is dry and of short duration. At a greater distance a series of reports are heard in rapid succession. At a still greater distance the noise, feeble at the commencement, changes into a prolonged rolling sound of varying intensity. If the lightning is at a greater distance than 14 or 15 miles, it is no longer heard, for sound is more imperfectly propagated through air than through solid bodies; hence, there are lightning discharges without thunder; these occur at times when the sky is cloudless.

Some attribute the noise of the rolling of thunder to the reflection of sound from the ground and from the clouds. Others have considered the lightning not as a single discharge, but as a series of discharges, each of which gives rise to a particular sound. But as these partial discharges proceed from points at different distances, and from zones of unequal density, it follows not only that they reach the ear of the observer successively, but that they bring sounds of unequal density, which occasion the duration and inequality of the rolling. The phenomenon has finally been ascribed to the zigzags of lightning themselves, assuming that the air at each salient angle is at its greatest compression, which would produce the unequal intensity of the sound.

950. **Effects of lightning.**—The lightning discharge is the electric discharge which strikes between a thunder-cloud and the ground. The latter, by the induction from the electricity of the cloud, becomes charged with contrary electricity; and when the tendency of the two electricities to combine exceeds the resistance of the air, the spark passes, which is often expressed by saying that a thunder-bolt has fallen. Lightning in general strikes from above, but *ascending lightning* is also sometimes observed; probably this is the case when the clouds being negatively the earth is positively electrified, for experiments show that at the ordinary pressure the positive fluid passes through the atmosphere more easily than negative electricity.

From the first law of electrical attraction, the discharge ought to fall first on the nearest and best-conducting objects, and, in fact, trees, elevated buildings, metals, are particularly struck by the discharge. Hence it is imprudent to stand under trees during a thunder storm.

The effects of lightning are very varied, and of the same kind as those of batteries (752), but of far greater intensity. The lightning discharge kills

men and animals, inflames combustible matters, melts metals, breaks bad conductors in pieces. When it penetrates the ground it melts the siliceous substance in its way, and thus produces in the direction of the discharge those remarkable vitrified tubes called *fulgurites*, some of which are as much as 12 yards in length. When it strikes bars of iron, it magnetises them, and often inverts the poles of compass needles.

After the passage of lightning, a highly peculiar odour is frequently produced like that perceived in a room in which an electrical machine is being worked. This odour was first attributed to the formation of an oxygenised compound, to which the name *osone* was given : but Schönbein, in 1840, showed that ozone is a peculiar allotropic modification of oxygen.

951. **Return shock.**—This is a violent and sometimes fatal shock which men and animals experience, even when at a great distance from the place where the lightning discharge passes. It is caused by the inductive action which the thunder-cloud exerts on bodies placed within the sphere of its activity. These bodies are then, like the ground, charged with the opposite electricity to that of the cloud ; but when the latter is discharged by the recombination of its electricity with that of the ground the induction ceases, and the bodies reverting rapidly from the electrical state to the neutral state, the concussion in question is reproduced, the *return shock*. A gradual decomposition and reunion of the electricity produces no visible effects ; yet it is alleged that such disturbances of the electrical equilibrium are perceived by nervous persons.

The return shock is always less violent than the direct one ; there is no instance of its having produced any inflammation, yet plenty of cases in which it has killed both men and animals ; in such cases no broken limbs, wounds, or burns are observed.

The return shock may be imitated by placing a gold-leaf electroscope connected by a wire with the ground near an electrical machine ; when the machine is worked, at each spark taken from the prime conductor the gold leaves of the electroscope diverge.

952. **Lightning conductor.**—The ordinary form of this instrument is an iron rod, through which passes the electricity of the ground attracted by the opposite electricity of the thunder-clouds. It was invented by Franklin in 1755.

There are two principal parts in a lightning conductor ; the rod and the conductor. The *rod* is a pointed bar of iron, fixed vertically to the roof of the edifice to be protected ; it is from 6 to 10 feet in height, and its basal section is about 2 or 3 inches in diameter. The conductor is a bar of iron which descends from the bottom of the rod to the ground, which it penetrates to some distance. As, in consequence of their rigidity, iron bars cannot always be well adapted to the exterior of buildings, they are best formed of wire cords, such as are used for rigging and for suspension bridges. In a report made by the Academy of Science on the construction of lightning conductors, the use of copper instead of iron wire in these conductors is recommended, inasmuch as copper is a better conductor than iron. The metallic section of the cords ought to be about  $\frac{1}{2}$  a square inch, and the individual wires 0·04 to 0·06 inch in diameter ; they ought to be twisted in

three strands, like an ordinary cord. The conductor is usually led into a well, and to connect it better with the soil it ends in two or three branches. If there is no well near, a hole is dug in the soil to the depth of 6 or 7 yards, and the foot of the conductor having been introduced, the hole is filled with powdered coke, which conducts very well and preserves the metal from oxidation.

The action of a lightning conductor depends on induction and the power of points (717) ; when a storm-cloud, positively electrified, for instance, rises in the atmosphere, it acts inductively on the earth, repels the positive and attracts the negative fluid, which accumulates on bodies placed on the surface of the soil, the more abundantly as these bodies are at a greater height. The density is then greatest on the highest bodies, which are therefore most exposed to the electric discharge ; but if these bodies are provided with metal points, like the rods of conductors, the negative electricity, withdrawn from the soil by the influence of the cloud, flows into the atmosphere, and neutralises the positive electricity of the cloud. Hence, not only does a lightning conductor tend to prevent the accumulation of electricity on the surface of the earth, but it also tends to restore the clouds to their natural state, both which concur in preventing lightning discharges. The disengagement of electricity is, however, sometimes so abundant, that the lightning conductor is inadequate to discharge the ground, and the lightning strikes ; but the conductor receives the discharge, in consequence of its greater conductivity, and the edifice is preserved.

A conductor, to be efficient, ought to satisfy the following conditions : i. the rod ought to be so large as not to be melted if the discharge passes ; ii. it ought to terminate in a point to give readier issue to the electricity disengaged by induction from the ground ; iii. the conductor must be continuous from the point to the ground, and the connexion between the rod and the ground must be as intimate as possible ; iv. if the building which is provided with a lightning conductor contains metallic surfaces of any extent, such as zinc roofs, metal gutters, or ironwork, these ought to be connected with the conductor. If the last two conditions are not fulfilled, there is a great danger of *lateral discharges* : that is to say that the discharge takes place between the conductor and the edifice, and then it only increases the danger.

953. **Rainbow.**—The *rainbow* is a luminous meteor which appears in the clouds opposite the sun when they are resolved into rain. It consists of seven concentric arcs, presenting successively the colours of the solar spectrum. Sometimes only a single bow is perceived, but there are usually two ; a lower one, the colours of which are very bright, and an external or *secondary* one, which is paler, and in which the order of the colours is reversed. In the interior rainbow the red is the highest colour ; in the other rainbow the violet is. It is seldom that three bows are seen ; theoretically a greater number may exist, but their colours are so feeble that they are not perceptible.

The phenomenon of the rainbow is produced by the decomposition of the white light of the sun when it passes into the drops and by its reflection from their inside face. In fact, the same phenomenon is witnessed in dew-drops and in jets of water ; in short, wherever solar light passes into drops of water under a certain angle.

The appearance and the extent of the rainbow depend on the position of the observer, and on the height of the sun above the horizon; hence only some of the rays refracted by the rain drops, and reflected in their concavity to the eye of the spectator, are adapted to produce the phenomenon. Those which do so are called *effective rays*.

To explain this let  $n$  (fig. 812) be a drop of water, into which a solar ray  $Sa$  penetrates. At a point of incidence,  $a$ , part of the light is reflected from



Fig. 812.

the surface of the liquid; another, entering it, is decomposed and traverses the drop in the direction  $ab$ . Arrived at  $b$ , part of the light emerges from the rain drop, the other part is reflected from the concave surface, and tends to emerge at  $g$ . At this point the light is again partially reflected, the remainder emerges in a direction  $gO$ , which forms with the incident ray,  $Sa$ , an angle, called the *angle of deviation*. It is such rays as  $gO$ , proceeding from the side next the observer, which produce on the retina the sensation of colours, provided the light is sufficiently intense.

It can be shown mathematically that in the case of a series of rays which impinge on the same drop, and only undergo a reflection in the interior, the angle of deviation increases from the ray  $S''n$ , for which it is zero, up to a certain limit, beyond which it decreases, and that near this limit rays passing parallel into a drop of rain, also emerge parallel. From this parallelism a beam of light is produced sufficiently intense to impress the retina; these are the rays which emerge parallel and are efficient.

As the different colours which compose white light are unequally refrangible, the maximum angle of deviation is not the same for all. For red rays the angle of deviation corresponding to the active rays is  $42^{\circ} 2'$ , and for violet rays it is  $40^{\circ} 17'$ . Hence, for all drops placed so that rays proceeding from the sun to the drop make, with those proceeding from the drop to the eye, an angle of  $42^{\circ} 2'$ , this organ will receive the sensation of red light; this will be the case with all drops situated on the circumference of the base of a cone, the summit of which is the spectator's eye; the axis of this cone is parallel to the sun's rays, and the angle formed by the two opposed generating lines is  $84^{\circ} 4'$ . This explains the formation of the red band in the rainbow; the angle of the cone in the case of the violet band is  $80^{\circ} 34'$ .

The cones corresponding to each band have a common axis called the *visual axis*. As this right line is parallel to the rays of the sun, it follows that when this axis is on the horizon, the visual axis is itself horizontal, and the rainbow appears as a semicircle. If the sun rises, the visual axis sinks, and with it the rainbow. Lastly, when the sun is at a height of  $42^{\circ} 2'$ , the arc disappears entirely below the horizon. Hence the phenomenon of the rainbow never takes place except in the morning and evening.

What has been said refers to the interior arc. The secondary bow is formed by rays which have undergone two reflections, as shown by the ray *S' idfe O*, in the drop *p*. The angle *S'IO* formed by the emergent and incident ray is called the angle of deviation. The angle is no longer susceptible of a maximum, but of a minimum, which varies for each kind of rays, and to which also efficient rays correspond. It is calculated that the minimum angle from violet rays is  $54^{\circ} 7'$ , and for red rays only  $50^{\circ} 57'$ ; hence it is that the red bow is here on the inside, and the violet arc on the outside. There is a loss of light for every internal reflection in the drop of rain, and, therefore, the colours of the secondary bow are always feebler than those of the internal one. The secondary bow ceases to be visible when the sun is  $54^{\circ}$  above the horizon.

The moon sometimes produces rainbows like the sun, but they are very pale.

954. **Aurora borealis.**—The *aurora borealis*, or northern light, or more properly, *polar aurora*, is a remarkable luminous phenomenon which is frequently seen in the atmosphere at the two terrestrial poles. The following is a description of an aurora borealis observed at Bossekop, in Lapland, lat.  $70^{\circ}$ , in the winter of 1838–1839.

In the evening, between 4 and 8 o'clock, the upper part of the fog which usually prevails to the north of Bossekop became coloured. This light became more regular, and formed an indistinct arc of a pale yellow, with its concave side turned towards the earth, while its summit was in the magnetic meridian.

Blackish rays soon separated the luminous parts of the arc. Luminous rays formed, becoming alternately rapidly and slowly longer and shorter, their lustre suddenly increasing and diminishing. The bottom of these rays always showed the brightest light, and formed a more or less regular arc. The length of the rays was very variable, but they always converged towards the same point of the horizon, which was in the prolongation of the north end of the dipping needle; sometimes the rays were prolonged as far as their point of meeting, and thus appeared like a fragment of an immense cupola.

The arc continued to rise in an undulatory motion towards the zenith. Sometimes one of its feet or even both left the horizon; the folds became more distinct and more numerous; the arc was now nothing more than a long band of rays convoluted in very graceful shapes, forming what is called the boreal crown. The lustre of the rays varied suddenly in intensity, and attained that of stars of the first magnitude; the rays darted with rapidity, the curves formed and reformed like the folds of a serpent (fig. 813), the base was red, the middle green, while the remainder retained its bright yellow



colour. Lastly, the lustre diminished, the colours disappeared; everything became feebler or suddenly went out.

A French scientific commission to the North observed 150 auroræ boreales in 200 days; it appears that at the poles, nights without an aurora borealis are quite exceptional, so that it may be assumed that they take place every night, though with varying intensity. They are visible at a considerable distance from the poles, and over an immense area. Sometimes the same aurora borealis has been seen at the same time at Moscow, Warsaw, Rome, and Cadiz. Their height is variously estimated at from 90 to 460 miles.



Fig. 813.

Mr. Newton found the mean height of 30 auroræ to be 133 miles; they are most frequent at the equinoxes, and least so at the solstices. The number differs in different years; attaining a maximum every 11 years at the same time as the sun-spots, and like these a minimum which is about 5 or 6 years from the maximum. The years 1844, 1855, 1860, and 1877 are poor in the appearance of the aurora.

There is moreover a period of about 60 years; for the years 1728, 1780, and 1842 have been remarkable for the prevalence of the aurora. The last two periods are also remarkable for the occurrence of disturbances in the earth's magnetism.

Numerous hypotheses have been devised to account for the auroræ boreales. The constant direction of their arc as regards the magnetic meridian, and their action on the magnetic needle (684), seem to show that they ought to be attributed to electric currents in the higher regions of the atmosphere. In high latitudes the aurora borealis acts powerfully on the wires of the electric telegraph; the alarms are for a long time violently rung, and despatches frequently interrupted by the spontaneous abnormal working of the apparatus.

The spectrum of the aurora borealis has been found by Vogel to consist

of five lines in the green, and of an indistinct line in the blue : to which must be added a red line due to the red protuberances ; these lines are the same as those of nitrogen greatly rarefied and at a low temperature.

According to De la Rive the auroræ boreales are due to electric discharges which take place in polar regions between the positive electricity of the atmosphere and the negative electricity of the earth ; electricities which themselves are separated by the action of the sun, principally in the equatorial regions.

The occurrence of irregular currents of electricity which manifest themselves by abnormal disturbances of telegraphic communications is not infrequent ; such currents have received the name of *earth currents*. Sabine has found that these magnetic disturbances are due to a peculiar action of the sun, and probably independently of its radiant heat and light. It has also been ascertained that the aurora borealis as well as earth currents invariably accompany these magnetic disturbances. According to Balfour Stewart, auroræ and earth currents are to be regarded as secondary currents due to small but rapid changes in the earth's magnetism ; he likens the body of the earth to the magnetic core of a Ruhmkorff's machine (887) ; the lower strata of the atmosphere forming the insulator, while the upper and rarer, and therefore electrically conducting strata, may be considered as the secondary coil.

On this analogy the sun may perhaps be likened to the primary current which performs the part of producing changes in the magnetic state of the core. Now in Ruhmkorff's machine the energy of the secondary current is derived from that of the primary current. Thus if the analogy be correct, the energy of the aurora borealis may in like manner come from the sun ; but until we know more of the connection between the sun and terrestrial magnetism these ideas are to be accepted with some reserve.

#### CLIMATOLOGY.

955. **Mean temperature.**—The *mean daily temperature*, or simply *temperature*, is that obtained by adding together 24 hourly observations, and dividing by 24. A very close approximation to the mean temperature is obtained by taking the mean of the highest and lowest temperatures of the day and of the night, which are determined by means of the maximum and minimum thermometers. These ought to be protected from the solar rays, to be raised above the ground, and far from all objects which might influence them by their radiation.

The temperature of a month is the mean of those of 30 days, and the temperature of the year is the mean of those of 12 months. Finally, the temperature of a place is the mean of its annual temperature, for a great series of years. The mean temperature of London is  $8.28^{\circ}$  C., or  $46.9^{\circ}$  F. The temperatures in all cases are those of the air and not those of the ground.

956. **Causes which modify the temperature of the air.**—The principal causes which modify the temperature of the air are the latitude of a place, its height, the direction of the winds, and the proximity of seas.

*Influence of the latitude.*—The influence of the latitude arises from the

greater or less obliquity of the solar rays, for as the quantity of heat absorbed is greater the nearer the rays are to the normal incidence (402), the heat absorbed decreases from the equator to the poles, for the rays are then more oblique. This loss is however, in summer, in the temperate and arctic zones, partially compensated by the length of the days. Under the equator, where the length of the days is constant, the temperature is almost invariable; in the latitude of London, and in more northerly countries, where the days are very unequal, the temperature varies greatly; but in summer it sometimes rises almost as high as under the equator. The lowering of the temperature produced by the latitude is small; thus in a latitude of 115 miles north of France, the temperature is only  $1^{\circ}$  C. lower.

*Influence of height.* The height of a place has a much more considerable influence on the temperature than its latitude. In the temperate zone a diminution of  $1^{\circ}$  C. corresponds in the mean to an ascent of 180 yards.

The cooling on ascending in the atmosphere has been observed in balloon ascents, and a proof of it is seen in the perpetual snows which cover the highest mountains. It is caused by the greater rarefaction of the air, which necessarily diminishes its absorbing power; besides which the air is at a greater distance from the ground, which heats it by contact; and finally dry air is very diathermanous.

The law of the diminution of temperature corresponding to a greater height in the atmosphere has not been made out, in consequence of the numerous disturbing causes which modify it, such as the prevalent winds, the hygrometric state, the time of day, etc. The difference between the temperature of two places at unequal heights is not proportional to the difference of level, but for moderate heights an approximation to the law may be made. As the mean of a series of very careful observations made during balloon ascents, a diminution of  $1^{\circ}$  C. corresponded to an increase in height of 232 yards.

*Direction of winds.* As winds share the temperature of the countries which they have traversed, their direction exercises great influence on the air in any place. In Paris, the hottest winds are the south, then come the south-east, the south-west, the west, the east, the north-west, north, and, lastly, the north-east, which is the coldest. The character of the wind changes with the seasons; the east wind, which is cold in winter, is warm in summer.

*Proximity of the seas.* The neighbourhood of the sea tends to raise the temperature of the air, and to render it uniform. The average temperature of the sea in equatorial and polar countries is always higher than that of the atmosphere. With reference to the uniformity of the temperature, it has been found that in temperate regions—that is, from  $25^{\circ}$  to  $50^{\circ}$  of latitude, the difference between the highest and lowest temperature of a day does not exceed, on the sea,  $2^{\circ}$  to  $3^{\circ}$ ; while upon the continent this amounts to from  $12^{\circ}$  to  $15^{\circ}$ . In islands the uniformity of temperature is very perceptible, even during the greatest heats. In continents, on the contrary, the winters for the same latitudes become colder, and the difference between the temperature of summer and winter becomes greater.

957. *Gulf Stream.*—A similar influence to that of the winds is exerted by currents of warm water. To one of these, the Gulf Stream, the mildness of

the climate in the north-west of Europe is mainly due. This great body of water, taking its origin in equatorial regions, flows through the Gulf of Mexico, from whence it derives its name; passing by the southern shores of North America, it makes its way in a north-westerly direction across the Atlantic, and finally washes the coast of Ireland and the north-west of Europe generally. Its temperature in the Gulf is about  $28^{\circ}$  C.; and it is usually a little more than  $5^{\circ}$  C. higher than the rest of the ocean on which it floats, owing to its lower specific gravity. To its influence is due the milder climate of west Europe as compared with that of the opposite coast of America; thus the river Hudson, in the latitude of Rome, is frozen over three months in the year. It also causes the polar regions to be separated from the coasts of Europe by a girdle of open sea; and thus the harbour of Hammerfest is open the year round. Besides its influence in thus moderating climate, the Gulf Stream is an important help to navigators.

958. **Isothermal lines.**—When on a map all the points whose temperature is known to be the same are joined, curves are obtained which Humboldt first noticed, and which he called *isothermal lines*. If the temperature of a place only varied with the obliquity of the sun's rays, that is, with the latitude, isothermal lines would all be parallel to the equator; but as the temperature is influenced by many local causes, especially by the height, the isothermal lines are always more or less curved. On the sea, however, they are almost parallel. A distinction is made between *isothermal lines*, *isothermal lines*, and *isochimenal lines*, where the mean *general*, the *mean summer*, and the *mean winter* temperatures are respectively constant. An *isothermal zone* is the space comprised between two isothermal lines. Kupffer also distinguishes *isogeothermic lines* where the mean temperature of the soil is constant.

959. **Climate.**—By the climate of a place is understood the whole of the meteorological conditions to which a place is subjected; its mean annual temperature, summer and winter temperatures, and by the extremes within which these are comprised. Some writers distinguish seven classes of climates according to their mean annual temperature: a *hot climate* from  $30^{\circ}$  to  $25^{\circ}$  C.; a *warm climate* from  $25^{\circ}$  to  $20^{\circ}$  C.; a *mild climate* from  $20^{\circ}$  to  $15^{\circ}$ ; a *temperate climate* from  $15^{\circ}$  to  $10^{\circ}$  C.; a *cold climate* from  $11^{\circ}$  to  $5^{\circ}$ ; a *very cold climate* from  $5^{\circ}$  to zero; and an *arctic climate* where the temperature is below zero.

Those climates, again, are classed as *constant climates*, where the difference between the mean and summer and winter temperature does not exceed  $6^{\circ}$  to  $8^{\circ}$ ; *variable climates*, where the difference amounts to from  $16^{\circ}$  to  $20^{\circ}$ ; and *extreme climates*, where the difference is greater than  $30^{\circ}$ . The climates of Paris and London are variable; those of Pekin and New York are extreme. Island climates are generally little variable, as the temperature of the sea is constant; and hence the distinction between land and sea climates. Marine climates are characterised by the fact that the difference between the temperature of summer and winter is always less than in the case of continental climates. But the temperature is by no means the only character which influences climates; there are, in addition, the moisture of the air, the quantity and frequency of the rains, the number

of storms, the direction and intensity of the winds, and the nature of the soil.

960. **Distribution of temperature on the surface of the globe.**—The temperature of the air on the surface of the globe decreases from the equator to the poles; but it is subject to perturbing causes so numerous and so purely local, that its decrease cannot be expressed by any law. It has hitherto not been possible to do more than obtain by numerous observations the mean temperature of each place, or the maximum and minimum temperatures. The following table gives a general idea of the distribution of heat in the northern hemisphere:—

*Mean temperature at different latitudes.*

Abyssinia . . . . .	31·0° C.	Paris . . . . .	10·8°C.
Calcutta . . . . .	28·5	London . . . . .	8·3
Jamaica . . . . .	26·1	Brussels . . . . .	10·2
Senegal . . . . .	24·6	Strasbourg . . . . .	9·8
Rio de Janeiro . . . . .	23·1	Geneva . . . . .	9·7
Cairo . . . . .	22·4	Boston . . . . .	9·3
Constantine . . . . .	17·2	Stockholm . . . . .	5·6
Naples . . . . .	16·7	Moscow . . . . .	3·6
Mexico . . . . .	16·6	St. Petersburg . . . . .	3·5
Marseilles . . . . .	14·1	St. Gothard . . . . .	-1·0
Constantinople . . . . .	13·7	Greenland . . . . .	-7·7
Pekin . . . . .	12·7	Melville Island . . . . .	-18·7

These are mean temperatures. The highest temperature which has been observed on the surface of the globe is 47·4° at Esne, in Egypt, and the lowest is -75° in the Arctic Expedition of 1876; which gives a difference of 122° between the extreme temperatures observed on the surface of the globe.

The highest temperature observed at Paris was 38·4° on July 8, 1793, and the lowest -23·5° on December 26, 1798. The highest observed at Greenwich was 35° C. in 1808, and the lowest -20° C. in 1838.

No arctic voyagers have succeeded in reaching the poles, in consequence of these seas being completely frozen, and hence the temperature is not known. In our hemisphere the existence of a single *glacial pole*, that is, a place where there was the maximum cold, has been long assumed. But the bendings which the isothermal lines present in the northern hemisphere have shown that in this hemisphere there are two, cold poles, one in Asia, to the north of Gulf Taymour, and the other in America, north of Barrow's Straits, about 15° from the earth's north pole. The mean temperature of the first of these poles has been estimated at -17°, and that of the second at -19°. With respect to the austral hemispheres, the observations are not sufficiently numerous to tell whether there are one or two poles of greatest cold, or to determine their position.

961. **Temperature of lakes, seas, and springs.**—In the tropics the temperature of the sea is generally the same as that of the air; in polar regions the sea is always warmer than the atmosphere.

The temperature of the sea under the torrid zone is always about 26° to

27° at the surface ; it diminishes as the depth increases, and in temperate as well as in tropical regions the temperature of the sea at great depths is between 2·5° and 3·5°. The temperature of the lower layers is caused by submarine currents which carry the cold water of the polar seas towards the equator.

The variations in the temperature of lakes are more considerable ; their surface, which becomes frozen in winter, may become heated to 20° or 25° in summer. The temperature of the bottom, on the contrary, is virtually 4°, which is that of the maximum density of water.

Springs which arise from rain water which has penetrated into the crust of the globe to a greater or less depth necessarily tend to assume the temperature of the terrestrial layers which they traverse. Hence when they reach the surface their temperature depends on the depth which they have attained. If this depth is that of the layer of invariable temperature, the springs have a temperature of 10° or 11° in this country, for this is the temperature of this layer, or about the mean annual temperature. If the springs are not very copious, their temperature is raised in summer and cooled in winter, by that of the layers which they traverse in passing from the invariable layer to the surface. But if they come from below the layer of invariable temperature, their temperature may considerably exceed the mean temperature of the place, and they are then called *thermal springs*. The following list gives the temperature of some of them :

Wildbad . . . . .	37·5°C.
Vichy . . . . .	40
Bath . . . . .	46
Ems . . . . .	46
Baden-Baden . . . . .	67·5
Chaudes-Aigues . . . . .	88
Trincheras . . . . .	67
Great Geyser, in Iceland, at a depth of 66 ft. . . . .	124

From their high temperature they have the property of dissolving many mineral substances which they traverse in their passage, and hence form *mineral waters*. The temperature of mineral waters is not modified in general by the abundance of rain or of dryness ; but it is by earthquakes, after which they have sometimes been found to rise and at others to sink.

962. **Distribution of land and water.**—The distribution of water on the surface of the earth exercises great influence on climate. The area covered by water is considerably greater than that of the dry land ; and the distribution is unequal in the two hemispheres. The entire surface of the globe occupies about 200 millions of square miles, nearly  $\frac{3}{4}$  of which is covered by water ; that is, the extent of the water is nearly three times as great as that of the land. The surface of the sea in the southern hemisphere is to that in the northern in about the ratio of 13 to 9.

The depth of the open sea is very variable, the lead generally reaches the bottom at about 300 to 450 yards ; in the ocean it is often 1,300 yards, and instances are known in which a bottom has not been reached at a depth of 4,500. It has been computed that the total mass of the water does not exceed that of a liquid layer surrounding the earth with a depth of about 1,100 yards.



# PROBLEMS AND EXAMPLES IN PHYSICS.

## I. EQUILIBRIUM.

1. A body being placed successively in the two pans of a balance, requires 180 grammes to hold it in equilibrium in one pan, and 181 grammes in the other; required the weight of the body to a milligramme.

From the formula  $x = \sqrt{p \cdot p}$ , we have

$$x = \sqrt{180 \times 181} = 180^{\text{m}}, 499.$$

2. What resistance does a nut offer when placed in a pair of nutcrackers at a distance of  $\frac{1}{4}$  of an inch from the joint, if a pressure of 5 pounds applied at a distance of 4 inches from the joint is just sufficient to crack it? *Ans.*  $26\frac{3}{4}$  pounds.

3. What force is required to raise a cask weighing 6 cwt. into a cart 0.8 metre high along a ladder 2.75 metres in length? *Ans.*  $195\frac{1}{2}$  pounds.

4. If a horse can move 30 cwt. along a level road, what can it move along a road the inclination of which is 1 in 80, the coefficient of friction on each road being  $\frac{1}{10}$ ? *Ans.*  $26\frac{1}{2}$  cwt.

5. The piston of a force-pump has a diameter of 8 centimetres, and the arms of the lever by which it is worked are respectively 12 and 96 centimetres in length; what force must be exerted at the longer arm if a pressure of 12.36 pounds on a square centimetre is to be applied? *Ans.* 78 pounds.

## II. GRAVITATION.

6. A stone is thrown from a balloon with a velocity of 50 metres in a second. How soon will the velocity amount to 99 metres in a second, and through what distance will the stone have fallen?

To find the time requisite for the body to have acquired the velocity of 99 metres in a second, we have

$$v = V + gt;$$

in which  $V$  is the initial velocity,  $g$  the acceleration of gravity which, with sufficient approximation, is equal to 9.8 metres in a second, and  $t$  the time. Substituting these values, we have

$$t = \frac{99 - 50}{9.8} = \frac{49}{9.8} = 5 \text{ seconds.}$$

For the space traversed we have

$$s = Vt + \frac{1}{2}gt^2 = 50 \times 5 + 4.9 \times 25 = 372.5 \text{ metres.}$$

7. A projectile was thrown vertically upwards to a height of 510<sup>m</sup>.22. Disregarding the resistance of the air, what was the initial velocity of the body?

The velocity is the same as that which the body would have acquired on falling from a height of 510.22 metres.

From the formula  $v = \sqrt{2gs}$  we get

$$v = \sqrt{2 \times 9.8 \times 510.22} = \sqrt{10000} = 100 \text{ metres.}$$

8. A stone is thrown vertically upwards with an initial velocity of 100 metres. After what time would it return to its original position?



In this case, since its velocity at its highest point is null, we have, from the formula  $v = V - gt$ ,

$$0 = 100 - gt, \text{ whence } t = \frac{100}{9.8} = 10.2 \text{ seconds.}$$

The time required for the body to fall is that in which it would have acquired the velocity of 100, that is  $100 = gt$  or  $t = 10.2$ , and therefore the whole time is  $2 \times 10.2 = 20.4$  seconds.

9. A stone is thrown vertically upwards with an initial velocity of 100 metres; after  $x$  seconds a second stone is thrown with the same velocity. The second stone is rising 8.7 seconds before it meets the first. What interval separated the throws?

The rising stone will have the velocity  $v = V - gt$ , whence  $v = 100 - 9.8 \times 8.7$ . On the other hand, the falling stone, at the moment the stones meet, will have the velocity given by the equation  $v = gt'$  in which  $t'$  is the time during which the stone falls before it meets the second one. This time is equal to 8.7 seconds +  $x - \frac{100}{9.8}$ . Hence its velocity is

$$v = 9.8 \left( 8.7 + x - \frac{100}{9.8} \right).$$

Equating the two values of  $v$  and reducing, we obtain  $x = 3$  seconds.

10. A body moving with a uniformly accelerated motion traverses a space of 1000 metres in 10 seconds. What would be the space traversed during the eighteenth second if the motion continued in the same manner?

The formula  $s = \frac{1}{2}gt^2$  gives for the accelerating force  $g = 20$  metres per second.

The space traversed during the eighteenth second will be equal to the difference of the space traversed in 18 seconds and that traversed at the end of the seventeenth.

$$x = \frac{20 \times 18^2}{2} - \frac{20 \times 17^2}{2} = 350 \text{ metres.}$$

11. A cannon-ball has been shot vertically upwards with a velocity of 250 metres in a second. After what interval of time would its velocity have been reduced to 54 metres under the retarding influence of gravity, and what space would have been traversed by the ball at the end of this time?

If  $t$  be the time, then at the end of each second the initial velocity would be diminished by  $9.8$ . Hence we shall have

$$54 = 250 - t \times 9.8, \text{ whence } t = 20 \text{ seconds;}$$

and for the space traversed

$$s = 250 \times 20 - \frac{9.8 \times 20^2}{2} = 3040 \text{ metres.}$$

12. Required the time in which a body would fall through a height of 2000 metres, neglecting the resistance of the air.

From  $s = \frac{1}{2}gt^2$  and substituting the values, we have

$$2000 = \frac{9.8}{2}t^2, \text{ whence } t = 20.2 \text{ seconds.}$$

13. A body falls in air from a height of 4000 metres. Required the time of its fall and its velocity when it strikes the ground.

From the formula  $s = \frac{1}{2}gt^2$  we have for the time  $t = \sqrt{\frac{2s}{g}}$ ; and, on the other

hand, from the formula for velocity  $v = gt$  we have  $t = \frac{v}{g}$ .

Hence  $\frac{v}{g} = \sqrt{\frac{2s}{g}}$ , from which  $v = \sqrt{2sg}$ , and substituting the values for  $s$  and  $g$ ,  $v = 200$  metres.

14. A stone is thrown into a pit 150 metres deep and reaches the bottom in 4 seconds. With what velocity was it thrown, and what velocity had it acquired on reaching the ground? *Ans.* The stone was thrown with a velocity of 17.9, and on reaching the ground had acquired the velocity 57.1.

15. A stone is thrown downwards from a height of 150 metres with a velocity of 10 metres per second. How long will it require to fall?

The distance through which the stone falls is equal to the sum of the distances through which it would fall in virtue of its initial impulse and of that which it would traverse under the influence of gravity alone: that is,  $150 = 10t + \frac{9.8t^2}{2}$ .

Taking the positive value only we get  $t = 4.61$  seconds.

16. How far will a heavy body fall in vacuo during the time in which its velocity increases from 40.25 feet per second to 88.55 feet per second?

*Ans.* Taking the value of  $g$  at 32.2 feet, the body falls through 96.6 feet.

17. Required the time of oscillation of a single pendulum whose length is 0.99384 and in a place where the intensity of gravity is 9.81.

From the general formula  $t = \pi \sqrt{\frac{l}{g}}$ , in which  $t$  expresses the time of one oscillation,  $l$  the length of the pendulum, and  $g$  the intensity of gravity, we have

$$t = 3.1416 \sqrt{\frac{0.99384}{9.81}} = 1 \text{ second.}$$

18. What is the intensity of gravity in a place in which the length of the seconds pendulum is 0.991?

In this case  $t = \pi \sqrt{\frac{l}{g}}$ ; and also  $t = \pi \sqrt{\frac{l'}{g'}}$ ; and therefore  $\frac{t}{g} = \frac{t'}{g'}$ , from which  $g' = \frac{gt'}{t}$ . Substituting in this latter equation the values of  $g'$ ,  $l$  and  $t$ , we have  $g' = 9.708$ .

19. In a place at which the length of the seconds pendulum is 0.99384, it is required to know the length of a pendulum which makes one oscillation in 5 seconds.

In the present case, as  $g$  remains the same in the general formula, and  $t$  varies, the length  $l$  must vary also. We shall have, then,

$$1 : 5 = \pi \sqrt{\frac{l}{g}} : \pi \sqrt{\frac{l'}{g}}$$

from which, reducing and introducing the values, we have

$$l' = 5^2 \times 0.99384 = 24.846.$$

20. A pendulum, the length of which is 1.95, makes 61,682 oscillations in a day. Required the length of the seconds pendulum. *Ans.* 0.99385 metres.

21. A pendulum clock loses 5 seconds in a day. By how much must it be shortened to keep correct time? *Ans.* By 0.000157 of its original length.

22. What is the normal acceleration of a body which traverses a circle of 4.2 metres diameter with a rectangular velocity of 3 metres? *Ans.* 4.286 metres.

23. An iron ball falls from a height of 68 cm. on a horizontal iron plate, and rebounds to a height of 27 cm. Required the coefficient of elasticity of the iron.

If an imperfectly elastic ball with the velocity  $v$  strikes against a plate, it rebounds with the velocity  $v_1 = -k v$ , from which, disregarding the sign,  $k = \frac{v_1}{v}$ . Now we

have the velocity  $v_1 = \sqrt{2gh}$ , and  $v = \sqrt{2g'h}$ , from which  $k = \frac{\sqrt{h}}{\sqrt{h'}}$ . Substituting the corresponding values, we get  $k = 0.63$ .

24. Two inelastic bodies, weighing respectively 100 and 200 pounds, strike against each other with velocities of 50 and 20 feet, what is their common velocity after the impact? *Ans.* 30, or 3.3, according as they move in the same or in opposite directions before impact.

### III. ON LIQUIDS AND GASES.

25. The force with which a hydraulic press is worked is 20 pounds; the arm of the

lever on which this force acts is 5 times as long as that of the resistance; lastly, the area of the large piston is 70 times that of the smaller one. Required the pressure transmitted to the large piston.

If  $F$  be the power, and  $p$  the pressure transmitted to the smaller piston, we have from the principle of the lever  $p \times 1 = F \times 5$ . Moreover, from the principle of the equality of pressure

$$P \times 1 = p \times 70 = 5 \times 20 \times 70 = 7000 \text{ pounds.}$$

26. The force with which a hydraulic press is worked being 30 kilos. and the arm of the lever by which this force is applied being 10 times as long as that of the resistance, and the diameter of the small piston being two centimetres; find the diameter of the large piston, in order that a pressure of 2000 kilos. may be produced.

*Ans.* 16.33 centimetres.

27. One of the limbs of a U-shaped glass tube contains mercury to a height of 0.175; the other contains a different liquid to a height of 0.42; the two columns being in equilibrium, required the density of the second liquid with reference to mercury and to water.

If  $d$  is the density of the liquid as compared with mercury and  $d'$  the density compared with water, then  $1 \times 0.175 = 0.42 \times d$ ; and  $13.6 \times 0.175 = 0.42 \times d'$ ; whence  $d = 0.416$  and  $d' = 5.66$ .

28. What force would be necessary to support a cubic decimetre of platinum in mercury at zero? Density of mercury 13.6 and that of platinum 21.5.

From the formula  $P = VD$  the weight of a cubic decimetre of platinum is  $1 \times 21.5 = 21.5$  and that of a cubic decimetre of mercury is  $1 \times 13.6 = 13.6$ . From the principle of Archimedes, the immersed platinum loses part of its weight equal to that of the mercury which it displaces. Its weight in the liquid is therefore  $21.5 - 13.6 = 7.9$ , and this represents the force required.

29. Given a body  $A$  which weighs 7.55 grammes in air, 5.17 gr. in water, and 6.35 gr. in another liquid,  $B$ ; required from these data the density of the body  $A$  and that of the liquid  $B$ .

The weight of the body  $A$  loses in water  $7.55 - 5.17 = 2.38$  grammes; this represents the weight of the displaced water. In the liquid  $B$  it loses  $7.55 - 6.35 = 1.2$  gr.; this is the weight of the same volume of the body  $B$ , as that of  $A$  and of the displaced water. The specific gravity of  $A$  is therefore

$$\frac{7.55}{2.38} = 3.172, \text{ and that of } B \frac{1.20}{2.38} = 0.504.$$

30. A cube of lead, the side of which is 4 cm., is to be supported in water by being suspended to a sphere of cork. What must be the diameter of the latter, the specific gravity of cork being 0.24, and that of lead 11.35?

The volume of the lead is 64 cubic centimetres; its weight in air is therefore  $64 \times 11.35$  and its weight in water  $64 \times 11.35 - 64 = 662.4$  gr.

If  $r$  be the radius of the sphere in centimetres, its volume in cubic centimetres will be  $\frac{4}{3} \pi r^3$ , and its weight in grammes is  $\frac{4}{3} \pi r^3 \times 0.24$ . Now, as the weight of the

displaced water is obviously  $\frac{4}{3} \pi r^3$  in grammes, there will be an upward buoyancy

represented by  $\frac{4}{3} \pi r^3 - \frac{4}{3} \pi r^3 \times 0.24 = \frac{4}{3} \pi r^3 \times 0.76$ , which must be equal to the

weight of the lead: that is  $\frac{4}{3} \pi r^3 \times 0.76 = 662.5$ , from which  $r = 5.00925$  and the diameter = 11.85.

31. A cylindrical steel magnet 15 cm. in length and 1.2 mm. in diameter, is loaded at one end with a cylinder of platinum of the same diameter and of such a length that when the solid thus formed is in mercury, the free end of the steel projects 10 mm. above the surface. Required the length of this platinum, specific gravity of steel being 7.8 and of platinum 21.5.

The weight of the steel in grammes will be  $15 \pi r^2 \times 7.8$  and of the platinum  $x \pi r^2 \times 21.5$ .

These are together equal to the weight of the displaced mercury, which is

$$\pi r^2 (14 + x) 13.6, \text{ from which } x = 9.01 \text{ cm.}$$

32. A cylindrical silver wire  $0.0015$  in diameter weighs  $3.2875$  grammes; it is to be covered with a layer of gold  $0.0002$  in thickness. Required the weight of the gold; the specific gravity of silver being  $10.47$  and that of gold  $19.26$ .

If  $r$  is the radius of the silver wire and  $R$  its radius when covered with gold, then  $r = 0.00075$  and  $R = 0.00095$ . The volume of the silver wire will be  $\pi r^2 l$  and its weight  $\pi r^2 l 10.47$ , from which  $l = 17.768$ .

The volume of the layer of gold is

$$\pi (R^2 - r^2) 17.768,$$

and its weight

$$\pi (0.00095^2 - 0.00075^2) \times 17.768 \times 19.26 = 3.657 \text{ nearly.}$$

33. A kilogramme of copper is to be drawn into wire having a diameter of  $0.16$  centimetre. What length will it yield? Specific gravity of copper  $8.88$ .

The wire produced represents a cylinder  $l$  cm. in length, the weight of which is  $\pi r^2 l 8.88$ , and this is equal to  $1000$  grammes. Hence  $l = 56.0085$ .

34. Determine the volumes of two liquids, the densities of which are respectively  $1.3$  and  $0.7$ , and which produce a mixture of three volumes having the density  $0.9$ .

If  $x$  and  $y$  be the volumes, then from  $P = VD$ ,  $1.3x + 0.7y = 3 \times 0.9$  and  $x + y = 3$ , from which  $x = 1$  and  $y = 2$ .

35. The specific gravity of zinc being  $7$  and that of copper  $9$ , what weight of each metal must be taken to form  $50$  grammes of an alloy having the specific gravity  $8.2$ ; it being assumed that the volume of the alloy is exactly the sum of the alloyed metals?

Let  $x$  = the weight of the zinc, and  $y$  that of the copper, then  $x + y = 50$ , and from the formula  $P = VD$ , which gives  $V = \frac{P}{D}$ , the volumes of the two metals and of

the alloy are respectively  $\frac{x}{7} + \frac{y}{9} = \frac{50}{8.2}$ . From these two equations we get  $x = 17.07$  and  $y = 32.93$ .

36. A platinum sphere  $3$  cm. in diameter is suspended to the beam of a very accurate balance, and is completely immersed in mercury. It is exactly counterbalanced by a copper cylinder of the same diameter completely immersed in water. Required the height of the cylinder. Specific gravity of mercury  $13.6$ , of copper  $8.8$ , and of platinum  $21.5$ .  
Ans.  $2.025$  centimetres.

37. To balance an ingot of platinum  $27$  grammes of brass are placed in the other pan of the balance. What weight would have been necessary if the weighing had been effected in vacuo? The density of platinum is  $21.5$ , that of brass  $8.3$ , and air under a pressure of  $760$  mm. and at the temperature  $0^\circ$  has  $\frac{1}{770}$  the density of water.

The weight of brass in air is not  $27$  grammes, but this weight minus the weight of a volume of air equal to its own.

$$\text{Since } P = VD \therefore V = \frac{P}{D} \text{ and the weight of the air is } \frac{P}{D \times 770} = \frac{27}{8.3 \times 770}.$$

By similar considerations, if  $x$  is the weight of platinum in vacuo, its weight in air will be  $x$  minus the weight of air displaced, that is  $x - \frac{x}{21.5 \times 770}$ , and this weight is equal to that of the true weight of the brass; and we have

$$x - \frac{x}{21.5 \times 770} = 27 - \frac{27}{8.3 \times 770}; \text{ from which } x = 26.996.$$

38. A body loses in carbonic acid  $1.15$  gr. of its weight. What would be its loss of weight in air and in hydrogen respectively?

Since a litre of air at  $0^\circ$  and  $760$  mm. weighs  $1.293$  gramme, the same volume of carbonic acid weighs  $1.293 \times 1.524 = 1.97$  gramme. We shall, therefore, obtain the

volume of carbonic acid corresponding to 1.15 gr. by dividing this number by 1.97, which gives 0.5837 litre. This being then the volume of the body, it displaces that volume of air, and therefore its loss of weight in air is  $0.5837 \times 1.293 = 0.7547$  grammes, and in hydrogen  $0.5837 \times 1.293 \times 0.069 = 0.052076$ .

39. Calculate the ascensional force of a spherical balloon of oiled silk which, when empty, weighs 62.5 kilos, and which is filled with impure hydrogen, the density of which is  $\frac{1}{13}$  that of air. The oiled silk weighs 0.250 kilo. the square metre.

The surface of the balloon is  $\frac{62.5}{0.25} = 250$  square metres. This surface being that of a sphere, is equal to  $4\pi R^2$ , whence  $4\pi R^2 = 250$  and  $R = 4.459$ ; therefore  $V = \frac{4}{3}\pi R^3 = 371.52$  cubic metres.

The weight of air displaced is  $371.52 \times 1.293$  kilo = 480.375 kilos; the weight of the hydrogen is 36.88 kilos, and therefore the ascensional force is

$$480.375 - (36.88 + 62.5) = 380.995.$$

40. A balloon 4 metres in diameter is made of the same material and filled with the same hydrogen as above. How much hydrogen is required to fill it, and what weight can it support?

The volume is  $\frac{4}{3}\pi R^3 = 33.51$  cubic metres, and the surface  $4\pi R^2 = 50.265$  square metres. The weight of the air displaced is  $33.51 \times 1.293 = 43.328$  kilos, and that of the hydrogen is from the above data 3.33 kilos, while the weight of the material is 12.566 kilos. Hence the weight which the balloon can support is

$$43.328 - (12.566 + 3.33) = 27.432 \text{ kil.}$$

41. Under the receiver of an air-pump is placed a balance, to which are suspended two cubes; one of these is 3 centimetres in the side, and weighs 26.324 gr., and the other is 5 centimetres in the side, and weighs 26.2597 grammes. When a partial vacuum is made these cubes just balance each other. What is the pressure? *Ans.* 0<sup>m</sup>.374.

42. A soap bubble 8 centimetres in diameter was filled with a mixture of one volume of hydrogen gas and 15 volumes air. The bubble just floated in the air; required the thickness of the film.

The weight of the volume of air displaced is  $\frac{4}{3}\pi r^3 \times 0.001293$  gramme, and that of the mixture of gases  $\frac{4}{3}\pi r^3 \times 0.001293 \times \frac{15 + 0.0693}{16}$ ; and the difference of these will equal the weight of the soap bubble.

This weight is that of a spherical shell, which, since its thickness  $t$  is very small, is with sufficient accuracy  $4\pi r^2 t s$  in grammes, where  $s$  is the specific gravity = 1.1. Hence

$$\frac{4}{3}\pi r^3 \left( 0.001293 - 0.001293 \times \frac{15.0693}{16} \right) = 4\pi r^2 t 1.1.$$

Dividing each side by  $\frac{4}{3}\pi r^2$ , and putting  $r = 4$ , we get

$$4 \times 0.001293 \left( 1 - \frac{15.0693}{16} \right) = 3.3 t;$$

or

$$0.001293 \times \frac{9307}{4} = 3.3 t;$$

whence  $t = 0.0009116629$  cm.

43. In a vessel whose capacity is 3 litres, there are introduced 2 litres of hydrogen under the pressure of 5 atmospheres; 3 litres of nitrogen under the pressure of half an atmosphere, and 4 litres of carbonic acid under the pressure of 4 atmospheres. What is the final pressure of the gas, the temperature being supposed constant during the experiment?

The pressure of the hydrogen, from Dalton's law, will be  $\frac{2 \times 5}{3}$ , that of the nitro-

gen will remain unchanged, and that of the carbonic acid will be  $\frac{4 \times 4}{3}$ . Hence the total pressure will be

$$\frac{10}{3} + \frac{1}{2} + \frac{16}{3} = 9\frac{1}{3} \text{ atmospheres.}$$

44. A vessel containing 10 litres of water is first exposed in contact with oxygen under a pressure of 78 cm. until the water is completely saturated. It is then placed in a confined space containing 100 litres of carbonic acid under a pressure of 72 cm. Required the volumes of the two gases when equilibrium is established. The coefficient of absorption of oxygen is 0.042, and that of carbonic acid unity.

The volume of oxygen dissolved is 0.42. Being placed in carbonic acid it will act as if it alone occupied the space of the carbonic acid, and its pressure will be  $78 \times \frac{0.42}{100.42} = 0.326$  cm.

Similarly the 10 litres of water will dissolve 10 litres of carbonic acid gas, the total volume of which will be 110, of which 100 are in the gaseous state and 10 are dissolved. Its pressure is therefore  $72 \times \frac{100}{110} = 65.454$  cm.

Hence the total pressure when equilibrium is established is

$$0.326 + 65.454 = 65.78 \text{ cm. ;}$$

and the volume of the oxygen dissolved reduced to the pressure 65.78 is

$$0.42 \times \frac{0.326}{65.78} = 0.00208, \text{ and that of the carbonic acid } 10 \times \frac{65.454}{45.78} = 9.95.$$

45. In a barometer which is immersed in a deep bath the mercury stands 745 mm. above the level of the bath. The tube is lowered until the barometric space, which contains air, is reduced to one-third, and the mercury is then at a height of 707 mm. Required the atmospheric pressure at the time of observation. *Ans.* = 764.

46. What is the pressure on the piston of a steam boiler of 8 decimetres diameter if the pressure in the boiler is 3 atmospheres? *Ans.* 10385.8.

47. What is the pressure of the atmosphere at that height at which an ascent of 21 metres correspond to a diminution of 1 mm in the barometric height? *Ans.* 380 mm.

48. What would be the height of the atmosphere if its density were everywhere uniform? *Ans.* 7987 metres, or nearly 5 miles.

49. How high must we ascend at the sea level to produce a depression of 1 mm. in the height of the barometer?

*Ans.* Taking mercury as 10500 times as heavy as air, the height will be 10.5 metres.

50. Mercury is poured into a barometer tube so that it contains 15 cc. of air under the ordinary atmospheric pressure. The tube is then inverted in a mercury bath and the air then occupies a space of 25 cc. ; the mercury occupying a height of 302 mm. What is the pressure of the atmosphere?

Let  $x$  be the amount of this pressure, the air in the upper part of the tube will have a pressure represented by  $\frac{15x}{25}$ , and this, together with the height of the mercurial column 302, will be the pressure exerted in the interior of the tube on the level of the mercury in the bath, which is equal to the atmospheric pressure ; that is  $\frac{15x}{25} + 302 = x$ , from which  $x = 755$  mm.

51. What effort is necessary to support a cylindrical bell-jar full of mercury immersed in mercury ; its internal diameter being 6 centimetres, its height  $ob$  above the surface of the mercury (fig. 1) 18 centimetres, and the pressure of the atmosphere 0.77 centimetre?

The bell-jar supports on the outside a pressure equal to that of a column of mercury, the section of whose base is  $cd$ , and the height that of the barometer. This pressure is equal to

$$\pi R^2 \times 0.77 \times 13.6.$$

Q Q

The pressure on the inside is that of the atmosphere less the weight of a column of mercury whose base is  $cd$  and height  $ob$ . This is equal to  $R^2 \times (0.77 - 0.18) \times 13$  and the effort necessary is the difference of these two pressures. Making  $R = 3$  cm., this is found to be 6.9216 kilograms.



FIG. 1.

52. A barometer is placed within a tube which is afterwards hermetically closed. At the moment of closing, the temperature is  $15^\circ$  and the pressure 750 mm. The internal space is then heated to  $30^\circ$ . What will be the height of the barometer?

The effect of the increase of temperature would be to raise the mercury in the tube in the ratio  $1 + \frac{30}{5550}$  to 1

$\frac{15}{5550}$ , and the height  $h$  would therefore be

$$h = \frac{76 \left( 1 + \frac{30}{5550} \right)}{1 + \frac{15}{5550}}$$

and since in the closed space, the elastic force of the air increases in the ratio  $1 + 15 : 1 + 30$  we shall have finally  $h = 301.74$  mm.

53. The heights of two barometers  $A$  and  $B$  have been observed at  $-10^\circ$  and  $+15^\circ$ , respectively, to be  $A = 737$  and  $B = 763$ . Required their corrected heights at  $0^\circ$ .  
*Ans.*  $A = 738.33$ .  $B = 760.94$ .

54. A voltaic current gives in an hour 840 cubic centimetres of detonating gas under a pressure of 760 and at the temperature  $12^\circ.5$ ; a second voltaic current gives in the same time 960 cubic centimetres under a pressure of 755 and at the temperature  $15^\circ.5$ . Compare the quantities of gas given by the two currents. *Ans.*  $1 : 1.125$ .



FIG. 2.

55. The volume of air in the pressure gauge of an apparatus for compressing gases is equal to 152 parts. By the working of the machine this is reduced to 37 parts, and the mercury is raised through 0.48 metre. What is the pressure of the gas?

Here  $AB = 152$ ,  $AC = 37$  parts, and  $BC = 0.48$ . The pressure of air therefore in  $AC$  is, from Boyle's law,

$$\frac{152}{37} = 4.1 \text{ atm} \cdot 108 = 3^m.122.$$

The pressure in the receiver is therefore

$$3.122 + 0.48 = 3^m.602,$$

which is equal to 4.74 atmospheres.

56. An air-tight bladder holding two litres of air at the standard pressure and temperature is immersed in sea water to a depth of 100 metres where the temperature is  $4^\circ$ . Required the volume of the gas.

The specific gravity of sea water being 1.026, the depth of 100 metres will represent a column of pure water 102.6 metres in height. As the pressure of an atmosphere is equal to a pressure of 10.33 metres of pure water, the pressure of this column

$$= \frac{102.68}{10.33} = 9.94 \text{ atm.}$$

Hence, adding the atmospheric pressure, the bladder is now under a pressure of 10.94 atmospheres, and its volume being inversely as the pressure will be  $\frac{2}{10.94} = 0.183$  litre,

As the temperature is increased by  $4^{\circ}$ , and therefore  
 from 277 to 273, and becomes

$$\times \frac{277}{273} = 0.1855 \text{ litre.}$$

When the air is raised in the tube of a pump by the first stroke of the  
 piston, the height of the tube 6 metres, and its section  
 of the air in the tube is under a pressure of 10 metres  
 of mercury as unity, that of the body of the pump is 10; and  
 the body of the pump are in the ratio of 6 to 5. Then  
 after the air is raised in the pipe, the volumes of air in the  
 body of the pump are 6 at the pressure 10, and  $5 + 6 - x$

in these terms, and solving, we have two values,  $x' = 18^m 26$   
 which must be rejected as being physically impossible;  
 the other value is 1.1 metres.

The capacity of 10 litres contains air under the pressure 76 cm.  
 of mercury, the surface of which is 32 square centimetres, and is weighted  
 by the pressure of the air is  $30^{\circ}$ ; its density at  $0^{\circ}$  and 76 cm.

The coefficient of the expansion of gases is 0.00366.

The air must be admitted to raise the valve.

When the air is not taken into account as it is under the pressure  
 of the atmosphere, the pressure in centimetres of mercury of that which is  
 present in kilogrammes its pressure on a square centi-  
 metre; and therefore the external pressure on the valve, and which is equal to the ex-  
 ternal pressure of 25 kilogrammes, is  $\frac{x}{1000} \times 13.6 \times 32 = 25 \text{ k.}$  From which  $x = 57.44$ .

For the weight we shall have

$$P = \frac{10 \times 0.001293}{1 + 0.00366 \times 30} \times \frac{57.44}{76.00} = 8.8055 \text{ grammes.}$$

59. A bell-jar contains 3.17 litres of air; a pressure gauge connected with it marks  
 zero when in contact with the air (fig. 3). The jar is closed and the machine worked;  
 the mercury rises to 65 cm. A second barometer stands at 76 cm. during the  
 experiment. Required the weight of air withdrawn  
 from the bell-jar and the weight of that which re-  
 mains.

At  $0^{\circ}$  and 76 cm. the weight of air in the bell-jar is

$$1.293 \times 3.17 = 4.09881.$$

At  $0^{\circ}$  and under the pressure 76 - 65 the weight  
 of the residual air is

$$\frac{4.09881 \times 11}{76} = 0.5932,$$

and therefore the weight of that which is withdrawn  
 is

$$4.0988 - 0.5932 = 3.5056 \text{ gr.}$$

60. The capacity of the receiver of an air-pump  
 is 7.53; it is full of air under the ordinary atmo-  
 spheric pressure and at  $0^{\circ}$ . Required the weight of air  
 when the pressure is reduced to 0.21; the weight  
 withdrawn by the piston; and the weight which would be left at  $15^{\circ}$ .

The weight of 7.53 litres of air under the ordinary conditions is 9.736 grammes.

Under a pressure of 0.21 it will be 2.09 grammes, and at the temperature  $15^{\circ}$  it will

$$\text{be } \frac{2.09}{1 + 0.00366 \times 15} = 0.255 \text{ gramme.}$$



FIG. 3.



61. In a theoretically perfect air-pump, how great is the rarefaction after 10 strokes, if the volumes of the barrel and the receiver are respectively 2 and 3?

$$\text{Ans.} = 4.59^{\text{mm}}; \text{ or about } \frac{1}{166} \text{ of an atmosphere.}$$

62. What must be the capacity of the barrel of an air-pump if the air in a receiver of 4 litres is to be reduced to  $\frac{1}{3}$  the density in two strokes? *Ans.* 2.9.

63. The reservoir of an air-gun, the capacity of which is 40 cubic inches, contains air whose density is 8 times that of the mean atmospheric pressure. A shot is fired when the atmospheric pressure is 741 mm. and the gas which escapes occupies a volume of 80 cubic inches. What is the elastic force of the residual air? *Ans.* 6.05 atmospheres.

64. Suppose that at the limit of the atmosphere the pressure of the attenuated air is the  $\frac{1}{1000}$  of a millimetre of mercury and the temperature  $-135^{\circ}$ , and that in a place at the sea level, in latitude  $45^{\circ}$ , the pressure of the atmosphere is  $760^{\text{mm}}$  and its temperature  $15^{\circ}$  C. Determine from these data the height of the atmosphere.

From the formula  $18400 \left\{ 1 + 0.002 \{ T + t \} \right\} \log \frac{H}{H_1}$ , we get for the height in metres 82237, which is equal to 51.1 miles.

65. If water is continually flowing through an aperture of 3 square inches with a velocity of 10 feet, how many cubic feet will flow out in an hour? *Ans.* 750 cubic feet.

66. With what velocity does water flow from an aperture of 3 square inches, if 37.5 cubic feet flow out every minute? *Ans.* 30 feet.

67. What is the ratio of the pressure in the above two cases? *Ans.* 1 : 9.

68. What is the theoretical velocity of water from an aperture which is 9 feet below the surface of water? *Ans.* 24 feet.

69. In a cylinder, water stands 2 feet above the aperture and is loaded by a piston which presses with a force of 6 pounds on the square inch. Required the velocity of the effluent water. *Ans.* 32 feet.

70. How deep must the aperture of the longer leg of a syphon, which has a section of 4 square centimetres, be below the surface of the water in order that 25 litres may flow out in a minute? *Ans.* 104 cm.

71. Through a circular aperture having an area of 0.0196 square cm. in the bottom of a reservoir of water which was kept at a constant level, 55 cm. above the bottom, it was found that 98.5 grammes of water flowed in 22 seconds. Required the coefficient of efflux.

Since the velocity of efflux through an aperture in the bottom of a vessel is given by the formula  $v = \sqrt{2gh}$ , it will readily be seen that the weight in grammes of water which flows in a given time,  $t$ , will be given by the formula  $w = a a t \sqrt{2gh}$ , where  $a$  is the area in square centimetres,  $a$  the coefficient of efflux,  $t$  the time in seconds, and  $h$  the height in centimetres. Hence in this case  $a = 0.69609$ .

72. Similarly through a square aperture, the area of which was almost exactly the same as the above, and at the same depth, 104.4 grammes flowed out in 21.6 seconds. In this case  $a = 0.73$ .

#### IV. ON SOUND.

73. A stone is dropped into a well, and 4 seconds afterwards the report of its striking the water is heard. Required the depth, knowing that the temperature of the air in the pit was  $10^{\circ}74$ .

From the formula  $v = 333 \sqrt{1 + at}$  we get for the velocity of sound at the temperature in question 343 metres.

Let  $t$  be the time which the stone occupies in falling; then  $\frac{1}{2}gt^2 = x$  will represent the depth of the well; on the other hand, the time occupied by the report will be  $4 - t$ ,

and the distance will be  $(4 - t)v = x$  (i); thus  $(4 - t)v = \frac{1}{2}gt^2$  (ii), from which, substituting the values,

$$(4 - t)343 = 4.9t^2$$

$t = 3.793$  seconds, and substituting this value in either of the equations (i) or (ii), we have the depth = 70.5 metres nearly.

74. A bullet is fired from a rifle with a velocity of 414 metres, and is heard to strike a target 4 seconds afterwards. Required the distance of the target from the marksman; the temperature being assumed to be zero.

$$\frac{x}{414} + \frac{x}{333} = 4; x = 738.2.$$

75. At what distance is an observer from an echo which repeats a sound after 3 seconds, the temperature of the air being  $10^\circ$ ?

In these 3 seconds the sound traverses a distance of  $3 \times 337 = 1011$  metres; this distance is twice that between the observer and the reflecting surface; hence the distance is

$$\frac{1011}{2} = 505 \text{ metres.}$$

76. Between a flash of lightning and the time at which the corresponding thunder is first heard two beats of the pulse are counted. Knowing that the pulse makes 80 beats in a minute, what is the distance of the discharge? *Ans.* 499.5 metres.

77. A stone is thrown into a well with a velocity of 12 metres; and is heard to strike the water 4 seconds afterwards. Required the depth of the well.

*Ans.* About 110 metres.

78. What is the velocity of sound in coal gas at  $0^\circ$ , the density being 0.5?

*Ans.* 475 metres.

79. What must be the temperature of air in order that sound may travel in it with the same velocity as in hydrogen at  $0^\circ$ ?

*Ans.* About  $3650^\circ$  C.

80. What must be the temperature of air in order that the velocity of sound may be the same as in carbonic acid at  $0^\circ$ ?

*Ans.*  $-105^\circ$  C.

81. The report of a cannon is heard 15 seconds after the flash is seen. Required the distance of the cannon, the temperature of the air being  $22^\circ$ .

From the formula for the velocity of sound we have

$$15 \times 333 \sqrt{1 + 0.003665 \times 22} = 5175 \text{ metres.}$$

82. If a bell is struck immediately at the level of the sea, and its sound, reflected from the bottom, is heard 3 seconds after, what is the depth of the sea?

*Ans.* 7140 feet.

83. A person stands 150 feet on one side of the line of fire of a rifle range 450 feet in length and at right angles to a point 150 feet in front of the target. What is the velocity of the bullet if the person hears it strike  $\frac{1}{9}$  of a second later than the report of the gun?

*Ans.* 2013 feet.

84. An echo repeats five syllables, each of which requires a quarter of a second to pronounce, and half a second elapses between the time the last syllable is heard, and the first syllable is repeated. What is the distance of the echo, the temperature of the air being  $10^\circ$  C.?

*Ans.* 295 metres.

85. The note given by a silver wire a millimetre in diameter and a metre in length being the middle C, what is the tension of the wire? *Ans.* 22.67 kilogrammes.

86. The density of iron being 7.8 and that of copper 8.8, what must be the thickness of wires of these materials, of the same length and equally stretched, so that they may give the same note?

From the formula for the transverse vibration of strings we have for the number of vibrations:  $n = \frac{1}{rl} \sqrt{\frac{P}{\pi d}}$ . As in the present case, the tensions, the length of the strings, and the number of vibrations are the same, we have

$$\frac{1}{rl} \sqrt{\frac{P}{\pi d}} = \frac{1}{r_1 l} \sqrt{\frac{P}{\pi d_1}}, \text{ from which } r \sqrt{d} = r_1 \sqrt{d_1};$$

$$\text{whence } \frac{r^2}{r_1^2} = \frac{d}{d_1} = \frac{8.8}{7.8}; \text{ hence } \frac{r}{r_1} = \sqrt{\frac{8.8}{7.8}} = 1.062.$$

87. A wire stretched by a weight of 13 kilos. sounds a certain note. What must be the stretching weight to produce the major third?

The major third having  $\frac{5}{4}$  the number of vibrations of the fundamental note, and as all other things being the same, the numbers of vibrations are directly as the square roots of the stretching weight, we shall have  $x = 20.312$  kilos.

88. The diameters of two wires of the same length and material are 0.0015 and 0.0038 m.; and their stretching weights 400 and 1600 grammes respectively. Required the ratio of the numbers of their vibrations. *Ans.  $n : n_1 = 1.266 : 1$ .*

89. A brass wire 1 metre in length stretched by a weight of 2 kilogrammes, and a silver wire of the same diameter, but 3.165 metres in length, give the same number of vibrations. What is the stretching weight in the latter case?

Since the number of vibrations is equal, we shall have

$$\frac{1}{rl} \sqrt{\frac{P}{\pi d}} = \frac{1}{r_1 l_1} \sqrt{\frac{x}{\pi d_1}};$$

from which, replacing the numbers, we get  $x = 25$  kilos.

90. A brass and a silver wire of the same diameter are stretched by the weights of 2 and 25 kilogrammes respectively, and produce the same note. What are their lengths, knowing that the density of brass is 8.39, and of silver 10.47?

*Ans.* The length of the silver wire is 3.16 times that of the brass.

91. A copper wire 1.25 mm. in diameter and a platinum one of 0.75 mm. are stretched by equal weights. What is the ratio of their lengths, if, when the copper wire gives the note C the platinum gives F on the diatonic scale?

*Ans.* The length of the silver is to the length of the platinum = 1.264 : 1.

92. An organ pipe gives the note C at a temperature 0°; at what temperature will it yield the major third of this note? *Ans. 153° C.*

93. A brass wire a metre in length, and stretched by a weight of a kilogramme, yields the same note as a silver wire of the same diameter but 2.5 metres in length and stretched by a weight of 7.5 kilogrammes. Required the specific gravity of the silver.

*Ans. 10.32.*

94. How many beats are produced in a second by two notes, whose rates of vibration are respectively 340 and 354? *Ans. 14.*

## V. ON HEAT.

95. Two mercurial thermometers are constructed of the same glass; the internal diameter of one of the bulbs is 7<sup>mm</sup>.5 and of its tube 2.5; the bulb of the other is 6.2 in diameter and its tube 1.5. What is the ratio of the length of a degree of the first thermometer to a degree of the second?

Let  $A$  and  $B$  be the two thermometers,  $D$  and  $D'$  the diameters of the bulbs, and  $d$  and  $d'$  the diameters of the tubes. Let us imagine a third thermometer  $C$  with the same bulb as  $B$  and the same tube as  $A$ , and let  $l$ ,  $l'$ , and  $l''$  denote the length of a degree in each of the thermometers respectively. Since the stems of  $A$  and  $C$  have the equal diameters, the lengths  $l$  and  $l''$  are directly as the volumes of the tubes, or what is the same, as the cubes of their diameters; and as  $B$  and  $C$  have

ury  
0  
r  
88  
r  
r  
r

# LIST OF TABLES.

	PAGE		PAGE
ABSORBING POWERS . . . . .	338	HARDNESS, scale of . . . . .	74
Absorption of gases . . . . .	112	LATENT heat, of evaporation . . . . .	291
heat by gases . . . . .	354	fusion . . . . .	377
liquids . . . . .	348	MAGNETIC declination . . . . .	577
vapours . . . . .	350, 355	inclination . . . . .	583
various bodies . . . . .	352	intensity . . . . .	586
Atmosphere, composition of . . . . .	117	RADIATING powers . . . . .	338, 346
BAROMETRIC variations . . . . .	128	Radiation of powders . . . . .	359
Breaking weight of substances . . . . .	73	Refraction, angle of double . . . . .	538
Boiling point . . . . .	284, 286	Refractive indices . . . . .	454, 455
of media of eye . . . . .	515	Reflecting powers . . . . .	337
CAPILLARITY in barometers . . . . .	126	SOUND, transmission of, in tubes . . . . .	178
Combustion, heat of . . . . .	400, 401	Specific gravity of solids . . . . .	96, 97
Conducting powers of solids for . . . . .	322	liquids . . . . .	98
heat . . . . .	324	heat of solids and liquids, 371-373 . . . . .	375
liquids for heat . . . . .	606	gases . . . . .	375
Conductors of electricity . . . . .	266	Inductive capacities . . . . .	624
DENSITIES of gases . . . . .	310	TANGENT galvanometer and volta- meter comparison between . . . . .	727
vapours . . . . .	258		
Density of water . . . . .	348, 349		
Diathermanous power . . . . .	109		
Diffusion of solutions . . . . .	815		
Diamagnetism . . . . .	107		

From the  
vibrations  
strings, at

87.  
be the  
The  
all other  
roots  
81  
0'00;  
the  
silv  
vib

fr

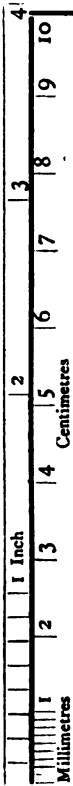

The area of the figure within the heavy lines is that of a square decimetre. A cube, one of whose sides is this area, is a cubic decimetre or *litre*. A litre of water at the temperature of  $4^{\circ}$  C. weighs a *kilogramme*. A litre of air at  $0^{\circ}$  C. and  $760^{\text{mm}}$  pressure weighs 1.293 grammes.

A litre is 1.76 *pints*; a pint is 0.568 of a litre.

The smaller figures in dotted lines represent the areas of a square centimetre and of a square inch.

A cubic centimetre of water at  $4^{\circ}$  C. weighs a *gramme*.

CHAPTER

- I. PROPERTIES
- II. TERRESTRIAL
- III. LAWS OF M
- IV. PROCESSES O

- I. FUNDAMENT
- II. QUANTITATI
- III. ACTION OF
- IV. STATE.

have the  
tubes, or what is the

the same bulk, the lengths  $l$  and  $l'$  are inversely proportionate to the sections of the stems, or what amounts to the same, to the squares of their diameters. We have then

$$\frac{l}{l'} = \frac{D^2}{D'^2} \text{ and } \frac{l}{l'} = \frac{d'^2}{d^2};$$

introducing the values and solving, we have

$$\frac{l}{l'} = 0.638.$$

96. At what temperature is the number on the Centigrade and Fahrenheit thermometers the same?

*Ans.* —  $40^\circ$ .

97. The same question for the Fahrenheit and Réaumur scales.

*Ans.* —  $25.6$ .

98. A capillary tube is divided into 180 parts of equal capacity, 25 of which weigh 1.2 gramme. What must be the radius of a spherical bulb to be blown to it so that 180 divisions correspond to 150 degrees Centigrade?

Since 25 divisions of the tube contain 1.2 gramme, 180 divisions contain  $1.2 \times \frac{180}{25} = 8.64$ .

And since these 180 divisions are to represent 150 degrees, the weight of mercury corresponding to a single degree is  $\frac{8.64}{150}$ . But as the expansion corresponding to

one degree is only the apparent expansion of mercury in glass, the weight  $\frac{8.64}{150}$  is  $\frac{1}{6480}$

of the mercury in the reservoir, which is  $\frac{4}{3} \pi R^3$ . From this  $R = 1.87$  centimetre.

99. By how much is the circumference of an iron wheel, whose diameter is 6 feet increased when its temperature is raised 400 degrees? Coefficient of expansion of iron = 0.000122.

*Ans.* By 0.092 foot.

100. What must be the length of a wire of this metal which for a temperature of  $1^\circ$  expands by one foot?

*Ans.* = 81967 feet.

101. A pendulum consists of a platinum rod, on a flattening at the end of which rests a spherical zinc bob. The length of the platinum is  $l$  at  $0^\circ$ . What must be the diameter of the bob, so that its centre is always at the same distance from the point of suspension whatever be the temperature? Coefficient of expansion of platinum 0.000088 and of zinc 0.000294.

*Ans.* The diameter of the bob must be  $\frac{3}{8}$  of the length of the platinum.

102. At the temperature zero a solid is immersed 0.975 of its total volume in alcohol. At the temperature  $25^\circ$  the solid is wholly immersed. The coefficient of expansion of the solid being 0.000026, required the coefficient of expansion of the alcohol.

*Ans.* 0.001052.

103. Into a glass globe, the capacity of which at  $0^\circ$  is 250 cc., are introduced 25 cc. of air measured at  $0^\circ$  and 76 cm. The flask being closed and heated to  $100^\circ$ , required the internal pressure. Coefficient of cubical expansion of glass  $\frac{1}{38700}$ .

At  $100^\circ$  the capacity of the flask is  $250 \left( 1 + \frac{100}{38700} \right)$ ; again at  $100^\circ$  the volume of the free air under the pressure 76 is  $25 \left( 1 + 0.00026 \times 100 \right)$ . But its real volume is  $250 \times \frac{388}{387}$  under a pressure  $x$ . Hence

$$76 : x = 250 \times \frac{388}{387} : 25 \times 1.366, \text{ from which } x = 10.3548 \text{ cm.}$$



FIG. 4.

104. The specific gravity of mercury at  $0^\circ$  being 13.6, required the volume of 30 kilogrammes at  $85^\circ$ . Coefficient of expansion  $\frac{1}{5550}$ .

The volume at  $0^\circ$  will be  $\frac{30}{13.6}$  and at  $85^\circ$   $\frac{30}{13.6} \times \left(1 + \frac{85}{5550}\right) = 2.239$  litres.

105. A hollow copper sphere 20 cm. in diameter is filled with air at  $0^\circ$  under a pressure of  $1\frac{1}{2}$  atmosphere; what is the total pressure on the interior surface when the enclosed air is heated to a temperature of  $600^\circ$ ? *Ans.* 6226.5 kilogrammes.

106. Between the limits of pressure 700 to 780 mm. the boiling point of water varies  $0.0375$  C. for each mm. of pressure. Between what limits of temperature does the boiling point vary, when the height of the barometer is between 735 and 755 mm.? *Ans.* Between  $99.0625$  and  $99.8125$ .

107. Liquid phosphorus cooled down to  $30^\circ$ , is made to solidify at this temperature. Required to know if the solidification will be complete, and if not, what weight will remain melted? The melting point of phosphorus is  $44.2$ ; its latent heat of fusion  $5.4$ , and its specific heat  $0.2$ .

Let  $x$  be the weight of phosphorus which solidifies; in so doing it will give out a quantity of heat =  $5.4x$ ; this is expended in raising the whole weight of the phosphorus from  $30$  to  $44.2$ . Hence we have  $5.4x = 1 \times (44.2 - 30) 0.2$ , from which  $x = \frac{2.84}{5.4} = 0.526$ , so that  $0.474$  of phosphorus will remain liquid.

108. A pound of ice at  $0^\circ$  is placed in two pounds of water at  $0^\circ$ ; required the weight of steam at  $100^\circ$  which will melt the ice and raise the temperature of the mixture to  $30^\circ$ . The latent heat of the liquefaction of ice is  $79.2$  and that of the vaporisation of water  $536$ . *Ans.* 279 pound.

109. 65.5 grammes of ice at  $-20^\circ$  having been placed in  $x$  grammes of oil of turpentine at  $-3^\circ$ , the final temperature is found to be  $-1^\circ$ . The specific heat of turpentine is  $0.4$ , and it is contained in a vessel weighing 25 grammes, whose specific heat is  $0.1$ . The specific heat of ice is  $0.5$ . Required the value of  $x$ .

*Ans.*  $x = 382.0$  grammes.

110. In what proportion must water at a temperature of  $30^\circ$  and linseed oil (sp. heat =  $0.5$ ) at a temperature of  $50^\circ$  be mixed so that there are 20 kilogrammes of the mixture at  $40^\circ$ ? *Ans.* Water = 6.66 kilos. and linseed oil = 13.34.

111. By how much will mercury at  $0^\circ$  be raised by an equal volume of water at  $100^\circ$ ? *Ans.*  $68.8$  C.

112. The specific heat of gold being  $0.03244$ , what weight of it at  $45^\circ$  will raise a kilogramme of water from  $12.3$  to  $15.7$ ?

Let  $x$  be the weight sought; then  $x$  kilogrammes of gold in sinking from  $45^\circ$  to  $15.7$  will give out a quantity of heat represented by  $x(45 - 15.7) 0.03244$ , and this is equal to the heat gained by the water that is to  $1(15.7 - 12.3) = 3.4$ , that is  $x = 3.58$ .

113. The specific heat of sulphide of copper is  $0.1212$  and that of sulphide of silver  $0.0846$ . 5 kilos. of a mixture of these two bodies at  $40^\circ$ , when immersed in 16 kilos. of water at  $7.66$  degrees, raises its temperature to  $10^\circ$ . How much of each sulphuret did the mixture contain?

The weight of the copper sulphuret = 2 and that of the silver sulphuret 3.

114. Into a mass of water at  $0^\circ$ , 100 grammes of ice at  $-12^\circ$  are introduced; a weight of  $7.2$  grammes of water at  $0^\circ$  freezes about the lump immersed, while its temperature rises to zero. Required the specific heat of ice. Latent heat of water  $79.2$ . *Ans.*  $0.48114$ .

115. Four pounds of copper filings at  $130^\circ$  are placed in 20 pounds of water at  $20^\circ$ , the temperature of which is thereby raised 2 degrees. What is the specific heat,  $c$ , of copper? *Ans.*  $c = 0.0926$ .

116. Two pieces of metal weighing 300 and 350 grammes, heated to a temperature  $x$ , have been immersed, the former in  $940.8$  grammes of water at  $10^\circ$ , and the latter in

546 grammes at the same temperature. The temperature in the first case rises to  $20^{\circ}$  and in the second to  $30^{\circ}$ . Required the original temperature and the specific heat of the metal. *Ans.*  $x$  the temperature =  $1908^{\circ}$ ;  $c$  the specific heat =  $\cdot 1038$ .

117. In what proportions must a kilogramme of water at  $50^{\circ}$  be divided in order that the heat which one portion gives out in cooling to ice at zero may be sufficient to change the other into steam at  $100^{\circ}$ ? *Ans.*  $x = 0\cdot830$ .

118. Three mixtures are formed by mixing two and two together, equal quantities of ice, salt, and water at  $0^{\circ}$ . Which of these mixtures will have the highest and which the lowest temperature? *Ans.* The mixture of ice and salt will produce the lowest temperature, while that of ice and water will produce no lowering of temperature.

119. In 25 $\cdot$ 45 kilogrammes of water at  $12^{\circ}\cdot 5$  are placed 6 $\cdot$ 17 kilos. of a body at a temperature of  $80^{\circ}$ ; the mixture acquires the temperature  $14^{\circ}\cdot 1$ . Required the specific heat of the body.

If  $c$  is the specific heat required, then  $mc(t - \theta)$  represents the heat lost by the body in cooling from  $80^{\circ}$  to  $14^{\circ}\cdot 1$ ; and that absorbed by the water in rising from  $12^{\circ}\cdot 5$  to  $14^{\circ}\cdot 1$  is  $m'(\theta - t)$ . These two values are equal. Substituting the numbers, we have  $c = 0\cdot 011$ .

120. Equal lengths of the same thin wire traversed by the same electrical current are placed respectively in 1 kilogramme of water and in 3 kilogrammes of mercury. The water is raised  $10^{\circ}$  in temperature, by how much will the mercury be raised?

*Ans.*  $100^{\circ}\cdot 04$ .

121. How many cubic feet of air under constant pressure are heated through  $1^{\circ}$  C. by one thermal unit? *Ans.* 52 cubic feet.

122. Given two pieces of metal, one  $x$  weighing 2 kilos. heated to  $80^{\circ}$ , and the other  $y$  weighing 3 kilos. and at the temperature  $50^{\circ}$ . To determine their specific heats they are immersed in a kilogramme of water at  $10^{\circ}$ , which is thereby raised to  $26^{\circ}\cdot 3$ .

The experiment is repeated, the two metals being at the temperature  $100^{\circ}$  and  $40^{\circ}$  respectively, and, as before, they are placed in a kilogramme of water at  $10^{\circ}$ , which this time is raised to  $28^{\circ}\cdot 4$ . Required the specific heats of the two metals.

*Ans.*  $x = \cdot 115$ ;  $y = 0\cdot 0555$ .

123. For high temperatures the specific heat of iron is  $0\cdot 1053 + 0\cdot 000017t$ . What is the temperature of a red-hot iron ball weighing a kilogramme which, plunged in 16 kilogrammes of water, raises its temperature from  $12^{\circ}$  to  $24^{\circ}$ ? What was the temperature of the iron?

$$(0\cdot 1053 + 0\cdot 000017t)(t - 24) = 16(24 - 12),$$

or  $0\cdot 000017t^2 + 1048892t - 2\cdot 5272 = 192$ ;

transposing and dividing by the coefficient of  $t^2$ , we get

$$t^2 + 6170t = 11442776,$$

$$t^2 + 6170t + (3085)^2 = 20960001;$$

hence  $t + 3085 = 4578\cdot 3$  nearly;  $\therefore t = 1493\cdot 3$ .

124. A kilogramme of the vapour of alcohol at  $80^{\circ}$  passes through a copper worm placed in 10 $\cdot$ 8 kilogrammes of water at  $12^{\circ}$ , the temperature of which is thereby raised to  $36^{\circ}$ . The copper worm and copper vessel in which the water is contained weigh together 3 kilogrammes. Required the latent heat of alcohol vapour. *Ans.* 210 $\cdot$ 4.

125. Determine the temperature of combustion of charcoal in burning to form carbonic acid.

We know from chemistry that one part by weight of carbon in burning unites with 2 $\frac{3}{4}$  parts by weight of oxygen to form 3 $\frac{3}{4}$  parts by weight of carbonic acid. Again the number of thermal units produced by the combustion of a pound of charcoa is 8080; the whole of this heat is contained in the 3 $\frac{3}{4}$  parts of carbonic acid produced, and if its specific heat were the same as that of water, its temperature would be  $\frac{8080}{3\frac{3}{4}} = 2204^{\circ}$  C.; but since the specific heat of carbonic acid is  $0\cdot 2163$  that of an equal



weight of water, the temperature will be  $\frac{2204}{0.2163} = 10189$  C.

126. A glass globe measuring 60 cubic centimetres is found to weigh 19.515 grammes when filled with air under a pressure of 752.3<sup>mm</sup> and at a temperature of 10° C. Some ether is introduced and vaporised at a temperature of 60°, whereupon the flask is sealed while quite full of vapour, the pressure being 753.4<sup>mm</sup>. Its weight is now found to be 19.6786 grammes. Required the density of the ether vapour compared with that of hydrogen. *Ans.* 54.4.

127. In a determination of the vapour density by Gay-Lussac's method, 0.1163 gramme of substance was employed. The volume observed was 50.79 cc, the height of the mercury above the level of that in the bath was 80.0<sup>mm</sup>, the height of the oil column reduced to millimetres of mercury 26.9; the temperature 215° C., and the height of the barometer at the time of observation 755.5<sup>mm</sup>. Required the specific gravity of the vapour as compared with that of hydrogen. *Ans.* 50.1.

128. Through a U-tube containing pumice saturated with sulphuric acid a cubic metre of air at 15° is passed, and the tube is found to weigh 3.95 grammes more. Required the hygrometric state of the air.

The pressure of aqueous vapour at 15° is 12.699; hence the weight of a cubic metre of aqueous vapour saturated at 15° is  $\frac{1293 \times 12.699 \times 5}{\left(1 + \frac{15}{273}\right) 760 \times 8} = 12.79$  grammes,

and the hygrometric state is  $\frac{3.95}{12.79} = 0.309$ .

129. The quantity of water given out by the lungs and skin may be taken at 30 ounces in 24 hours. How many cubic inches of air already half saturated at 10° will be fully saturated by the moisture exhaled from the above two sources by one man? Tension of aqueous vapour in inches = 0.532. Pressure of the atmosphere = 30 inches. *Ans.* 328782.5 c.i. = a cube 5.752 feet in the side.

130. A mass of air extending over an area of 60,000 square metres to a height of 300 metres has the dew point at 15°, its temperature being 20°. How much rain will fall if the temperature sinks to 10°?

The weight of vapour condensed from one cubic metre under these circumstances will be 3.1435 grammes, and therefore from 18,000,000 cubic metres it will be 56,583 kilogrammes, which is equal to a rainfall 0.0943 mm. in depth.

131. When 3 cubic metres of air at 10° and 5 cubic metres at 18°, each saturated with aqueous vapour at those temperatures, are mixed together, is any water precipitated? And if so, how much?

The weight of water contained in the two masses under the given conditions are respectively 28.18 and 76.59 grammes; the weight required to saturate the mixture at the temperature of 15° is 102.39 grammes, and therefore 2.38 grammes will be precipitated.

132. The temperature of the air at sunset being 10°, what must be the lowest hygrometric state, in order that dew may be deposited, it being assumed that in consequence of nocturnal radiation the temperature of the ground is 7° below that of the air? *Ans.* The hygrometric state must be at least 0.62 of total saturation.

133. It is stated as a practical rule that when the tension of aqueous vapour present in the atmosphere, as indicated by the dew point, is equal to  $x$  mm. of mercury the weight of water present in a cubic metre of that air is  $x$  grammes. What is the error in this statement for a pressure of 10 mm. and the temperature 15° C.?

*Ans.* 0.172 gr.

134. A raindrop falls to the ground from a height of a mile; by how much would its temperature be raised, assuming that it imparts no heat to the air or to the ground? *Ans.* 3° 8 C.

135. A lead bullet falls through a height of 10 metres; by what amount will its temperature have been raised when it reaches the ground, if all the heat is expended in raising the temperature of the bullet? *Ans.* 0.744° C.

136. From what height must a lead bullet fall in order that its temperature may be raised  $n$  degrees?—and what velocity will it have acquired? It is assumed that all the heat is expended in raising the temperature of the bullet, the specific heat of lead is taken at  $0.0314$ , and Joule's equivalent in metres at  $424$ .

*Ans.*  $13.31 \times n$  metres;  $v = 16.2 \sqrt{n}$ .

137. How much heat is disengaged if a bullet weighing 50 grammes and having a velocity of 50 metres strikes a target?

*Ans.* Sufficient to raise one gramme of water through  $15^{\circ}$  C.

138. How much heat is produced in the room of a manufactory in which  $1.2$  horse-power of the motor is consumed each hour in overcoming the resistance of friction?

*Ans.* A quantity sufficient to raise  $41024$  pounds of water one degree Centigrade.

139. What is the ratio between the quantities of heat which are respectively produced, when a bullet weighing 50 grammes and having a velocity of 500 metres, and a cannon-ball weighing 40 kilogrammes with a velocity of 400 metres, strike a target?

*Ans.*  $1 : 512$ .

## VI. LIGHT.

140. How many candles are required to produce at a distance of  $2.5$  metres, the same illuminating effect as one candle at a distance of  $0.45$  m.?

*Ans.* 31.

141. Two sources of light whose intensities are as  $1 : 2$  are two metres apart. At what position is a space between them equally illuminated?

*Ans.*  $0.82$  metre from the less intense light.

142. A candle sends its rays vertically against a plane surface. When the candle is removed to thrice the distance and the surface makes an angle of  $60^{\circ}$  with the original position, what is the ratio of the illuminations in the two cases?

*Ans.*  $1 : \frac{1}{18}$ .

143. An observer, whose eye is 6 feet above the ground, stands at a distance of 18 feet from the near edge of a still pond, and sees there the image of the top of a tree, the base of which is at a distance of 100 yards from the place at which the image is formed. Required the height of the tree.

*Ans.* 100 feet.

144. What is the height of a tower which casts a shadow  $56.4$  in length when a vertical rod  $0.95$  m. in height produces a shadow  $1.38$  in length?

*Ans.* 38.8.

145. A minute hole is made in the shutter of a dark room, and at a distance of  $2.5$  metres a screen is held. What is the size of the image of a tree which is  $15.3$  metres high and is at a distance of 40 metres?

*Ans.*  $0.95625$  metre.

146. What is the length of the shadow of a tree 50 feet high when the sun is  $30^{\circ}$  above the horizon? What when it is  $45^{\circ}$ , and  $60^{\circ}$ ?

*Ans.*  $86.6$ ; 50, and  $28.867$  feet.

147. Under what visual angle does a line of 30 feet appear at a distance of 18 feet?

*Ans.*  $79^{\circ} 36'$ .

148. The apparent diameter of the moon amounts to  $31' 3''$ . What is its real diameter if its distance from the earth is taken at 239000 geographical miles?

*Ans.* 2166 geographical miles.

149. For an ordinary eye an object is visible with a moderate illumination and pure air under a visual angle of 40 seconds. At what distance, therefore, can a black circle (6 inches in diameter) be seen on a white ground?

*Ans.* 2578 feet.

150. At what distance from a circle with a diameter of one foot is the visual angle a second?

*Ans.* 206265 feet.

151. At what distance would a circular disc 1 inch in diameter, of the same brightness as the sun's surface, illuminate a given object to the same extent as a vertical sun in the tropics, the light absorbed by the air being neglected?

*Ans.* Taking the sun's angular diameter at  $30'$ ,  $x = 38$  inches.

152. What is the minimum deviation for a glass prism ( $n = 1.53$ ), whose refracting angle is  $60^{\circ}$ ?

*Ans.*  $39^{\circ} 48'$ .

153. What is the minimum deviation for a prism of the same substance when the refracting angle is  $45^\circ$ ? *Ans.*  $63^\circ 38'$ .

154. The refracting angle of a prism of silicate of lead has been found by measurement to be  $21^\circ 12'$ , and the minimum deviation to be  $24^\circ 46'$ . Required the refractive index of the substance. *Ans.*  $2.122$ .

155. Construct the path of a ray which falls on an equiangular crown-glass prism at an angle of  $30^\circ$ ; and find its deviation. *Ans.*  $70^\circ 45'$ .

156. What are the angles of refraction upon a ray which passes from air into glass at an angle of  $40^\circ$ ; from air into water at an angle of  $65^\circ$ ; and from air into diamond at an angle of  $80^\circ$ ? *Ans.*  $25^\circ 22'$ ;  $43^\circ 49'$ ;  $23^\circ 12'$ .

157. The focal distance of a concave mirror is 8 metres. What is the distance of the image from the mirror when the object is at a distance of 12, 5, and 7 metres respectively? *Ans.*  $24$ ;  $-13.3$  and  $-36$ .

158. An object at a distance of 10 feet produces a distinct image at a distance of 3 feet. What is the focal distance of the mirror? *Ans.*  $2.3077$  feet.

159. Required the focal distance of a crown glass meniscus, the radius of curvature of the concave face being 45 mm., and that of the convex face 30 mm.; the index of refraction being 1.5. *Ans.*  $f = 180$  mm.

160. What is the principal focal distance of a double-convex lens of diamond, the radius of curvature of each of whose faces is 4 mm., and the refractive index of diamond  $2.487$ ? *Ans.*  $1.34$  mm.

161. A watch-glass with ground edges, the curvature of which was 4.5 cm., was filled with water and a glass plate slid over it. The focus of the plano-convex lens thus formed was found to be 13.5 cm. Required the refractive index of the water. *Ans.*  $n = 1.33$ .

162. What is the focal distance of a double-convex lens when the distances of the image and object are respectively 5 and 36 centimetres? *Ans.*  $4.4$  centimetres.

163. The radii of curvature of a double-convex lens of crown glass are six and eight inches. What is the focal distance? *Ans.*  $6.85$  inches.

164. The focal distance of a double-convex lens is 4 inches, the radius of curvature of one of its faces is 3 inches. What is that of the second? *Ans.* 6 inches.

165. The radius of curvature of a plano-convex lens is 12 inches. Required its focal distance. *Ans.* 24 inches.

166. If the focal distance of a double-convex lens is 1 centimetre, at what distance must a luminous object be placed so that its image is formed at 2 centimetres' distance from the lens? *Ans.* 2 centimetres.

167. A candle at a distance of 120 centimetres from a lens forms an image on the other side of the lens at a distance of 200 feet. Required the nature of the lens and its focal distance. *Ans.* It is a convex lens, and its focal distance is 75 cm.

168. A plano-convex lens was found to produce at a distance of 62 cm. a sharp image of an infinitely distant object. In front of the same lens, at a distance of 84 cm., a millimetre scale was placed, and a sharp image was formed at a distance of 250 cm. It was thus found that 10 millimetres in the object corresponded to 29 in the image. From these three observations determine the focal distance of the lens. *Ans.* The mean of the three results is  $62.4$ .

169. The image of a distant tree was sharply formed at a distance of 31 cm. from the centre of a concave mirror.

In another case the image of an object 18 mm. in length at a distance of 405 mm. from the mirror was formed at 1350 mm. from the mirror and had a length of 61 mm. In another experiment the distances of object and image and the size of the image were respectively 2200, 355, and 3 mm.

Deduce from these several data the focal distance of the mirror. *Ans.*  $31.2; 30.5$ .

## VII. MAGNETISM AND FRICTIONAL ELECTRICITY.

170. A compass needle at the magnetic equator makes 15 oscillations in a minute; how many will it make in a place where the horizontal force of the earth's magnetism is  $\frac{16}{25}$  as great? *Ans. 12.*

171. A compass needle makes 9 oscillations a minute under the influence of the earth's magnetism alone; how many will it make when re-magnetised so as to be half as strong again as before? *Ans. 11.*

172. A small magnetic needle makes 100 oscillations in 7 min. 42 secs. under the influence of the earth's force only; when the south pole of a long bar magnet A is placed 10 inches north of it, it makes 100 oscillations in 4 min. 3 secs.; and with the south pole of another magnet B in the same place, it makes 100 oscillations in 4 min. 48 secs. What are the relative strengths of the magnets A and B?

*Ans. A = 1'404 B.*

173. On a table where the earth's magnetism is counteracted, the north pole of a compass needle makes 20 oscillations in a minute under the attraction of a south pole 4 inches distant; how many will it make when the south pole is 3 inches distant?

*Ans. 26'6.*

174. If the oscillating magnet be re-magnetised so as to be twice as strong as before, how many oscillations in a minute will it make? *Ans. 37'71.*

175. At one end of a light glass thread, carefully balanced so as to oscillate in a vertical plane, is a pith ball. Over this and in contact with it is a fixed pith ball of the same dimensions. Both balls being charged with the same electricity it is found that to keep them 1'4 inch apart, a weight of '9 mgr. must be placed at the free end of the glass thread. What weight must be placed there to keep the balls 1'05 inch apart?

*Ans. 1'6 mgr.*

176. A small insulated sphere A charged with the quantity of + electricity  $\alpha$  is at a distance of 25 mm. from a second similar sphere B charged with the quantity  $\gamma$ ; the latter is momentarily touched with an unelectrified sphere C, of the same size, and the distance altered to 20 mm. What is the ratio of the repulsive forces in the two cases?

*Ans. 32 : 25.*

177. Two insulated spheres whose diameters are respectively as 7 : 10 have equal quantities of electricity imparted to them. In what ratio are their electrical densities?

*Ans. 100 : 49.*

178. Two such spheres whose diameters are as 3 : 5 contain respectively the quantities of electricity 7 and 10. In what ratio are their densities? *Ans. 35 : 18.*

## VIII. VOLTAIC ELECTRICITY.

179. A galvanometer offering no appreciable resistance is connected by short thick wires with the poles of a cell, and deflects  $20^\circ$ . By how much will it be deflected if two exactly similar cells are connected with the first side by side? *Ans.  $47^\circ 30$ .*

180. By how much if the three cells are connected in series? *Ans.  $20^\circ$ .*

181. Two cells each of 1 ohm resistance are connected in series by a wire the resistance of which is also 1 ohm. If each of these when connected singly by short thick wires to a galvanometer of no appreciable resistance deflects it  $25^\circ$ , how much will the combination deflect it, the connections being made by short thick wires?

*Ans.  $17^\circ 16$ .*

A Siemen's unit is equal to the resistance of a column of pure mercury a metre in length and a square mm. in cross section. It is equal to 0'9536 of an ohm or  $\frac{1}{10485}$  unit; or a B A unit equals 1'0485 Siemen's unit, or equals a column of mercury 1'0485 metre in length and a square mm. in cross section.

182. A single thermo-electric couple deflects a galvanometer of 100 ohms resist-

ance  $0^{\circ} 30'$ ; how much will a series of 30 such couples deflect it, the connections being made by short thick wires? *Ans.*  $14^{\circ} 40'$ .

183. Suppose a sine galvanometer had been used in the last question, and the first reading had been  $0^{\circ} 30'$ , what would the second be? *Ans.*  $15^{\circ} 10'$ .

184. The internal resistance of a cell is half an ohm; when a tangent galvanometer of 1 ohm resistance is connected with it by short thick wires it is deflected  $15^{\circ}$ ; by how much will it be deflected if for one of the thick wires a thin wire of  $1\frac{1}{2}$  ohm resistance is substituted? *Ans.*  $7^{\circ} 37'$ .

185. What will be the deflection if each of the wires is replaced by a thin wire of  $1\frac{1}{2}$  ohm resistance? *Ans.*  $5^{\circ} 5'$ .

186. A cell of one-third of an ohm resistance deflects a tangent galvanometer of unknown resistance  $45^{\circ}$ , the connection being made by two short thick wires. If a wire of 3 ohms resistance be substituted for one of the short wires the deflection is  $30^{\circ}$ . What is the resistance of the galvanometer? *Ans.*  $3\cdot75$  ohms.

187. What would be the deflection if for the cell in the last question three exactly similar cells in series were substituted (a) when the galvanometer alone is in circuit; (b) when both the galvanometer and the thin wire are in circuit? *Ans.* a  $66^{\circ} 10'$ . b  $55^{\circ} 30'$ .

188. A galvanometer offering no sensible resistance is deflected  $50^{\circ}$  by a cell connected with it by short thick wires. If a resistance of 3 ohms be put in the circuit, the deflection is  $20^{\circ}$ . Find the internal resistance of the cell. *Ans.*  $1\cdot49$ .

189. Suppose the results in the last question were produced by two exactly similar cells in series, find the internal resistance of each. *Ans.*  $0\cdot65$ .

190. Suppose they were produced by two exactly similar cells placed side by side, find the internal resistance of each. *Ans.*  $2\cdot63$ .

191. If the resistance of 130 yards of a particular copper wire  $\frac{1}{16}$  of an inch in diameter is an ohm, express in that unit the resistance of 8242 yards of copper wire  $\frac{1}{12}$  of an inch in diameter. *Ans.*  $35\cdot66$ .

192. One form of fuse for firing mines by voltaic electricity consists of a platinum wire  $\frac{1}{8}$  of an inch long, of which a yard weighs 2 grains. Required its resistance in terms of a Siemens unit. Specific gravity of platinum 22, and its conducting power 11·25 that of mercury. *Ans.*  $0\cdot131$ .

193. Express in ohms the resistance of one mile of copper wire  $\frac{1}{4}$  of an inch in diameter of the same quality as that referred to in 191. *Ans.*  $0\cdot8$ .

194. The whole resistance of a copper wire going round the earth (24800 miles) is 221650 ohms. Find its diameter in inches. *Ans.*  $\frac{1}{13}$ .

195. How much platinum wire  $0\cdot05$  of an inch in diameter must be taken to get a resistance equal to 1 ohm, the specific resistance of platinum being taken at 5·55 that of copper? *Ans.*  $14\cdot26$ .

196. 660 yards of iron wire  $0\cdot0625$  of an inch in diameter have the same electrical resistance as a mile of copper wire  $0\cdot0416$  of an inch in diameter. Find the specific resistance of iron, that of copper being unity. *Ans.* 6.

197. Ten exactly similar cells in series produce a deflection of  $45^{\circ}$  in a tangent galvanometer, the external resistance of the circuit being 10 ohms. If arranged so that there is a series of 5 cells, of two abreast, a deflection of  $33^{\circ} 42'$  is produced; find the internal resistance of the cell. *Ans.*  $\frac{1}{2}$  ohm.

198. On the bobbins of the new Post Office pattern of a single needle instrument are coiled 225 yards of No. 35 copper wire  $0\cdot0087$  inch in diameter, the resistance of which is about 92 ohms. Required the conducting power of the wire in terms of mercury. *Ans.* 56.

199. Ten exactly similar cells each of  $\frac{1}{2}$  of an ohm resistance give; when arranged

in five series of 2 each, a deflection of  $23^{\circ}57'$ ; but when arranged in 2 series of 5 each a deflection of  $33^{\circ}42'$ . Required the external resistance of the circuit including that of the galvanometer. *Ans.*  $\frac{1}{11}$ .

200. A cell in a certain circuit deflects a tangent galvanometer  $18^{\circ}26'$ ; two such cells abreast in the same circuit deflect it  $23^{\circ}57'$ ; two such cells in the same circuit diminished by 1 ohm deflect it  $29^{\circ}2'$ . Find the internal resistance of one cell and that of the circuit. *Ans.*  $R = r = 1.66$ .

201. What is the best arrangement of 6 cells, each of  $\frac{1}{2}$  of an ohm resistance, against an external resistance of 2 ohms?

*Ans.* Indifferent whether in 6 cells of 1 each or in 3 cells of 2 each.

202. What is the best arrangement of 20 cells, each of 0.8 ohm resistance, against an external resistance of 4 ohms? *Ans.* 10 cells of 2 each.

203. In a circuit containing a galvanometer and a voltmeter, the current which deflects the galvanometer  $45^{\circ}$  produces 10.32 cubic centimetres of mixed gas in a minute. The electrodes are put farther apart, and the deflection is now  $20^{\circ}$ ; find how much gas is now produced per minute. *Ans.* 3.75 cc.

204. 100 inches of copper wire weighing 100 grains has a resistance of 0.1516 ohm. Required the resistance of 50 inches weighing 200 grains. *Ans.* 0.01895.

205. A knot of nearly pure copper wire weighing one pound has a resistance of 1200 ohms at  $15^{\circ}5$  C.; what is the resistance of a knot of the same quality of wire weighing 125 pounds? *Ans.* 9.6 ohms.

206. Find the length in yards of a wire of the same diameter and quality as the knot pound in 178, having a resistance of 2 ohms. *Ans.* 3.38 yards.

207. Find the length in yards of a wire of the same quality and total resistance as the knot pound in 178, but of three times the diameter. *Ans.* 18261 yards.

208. The specific gravity of platinum is  $2\frac{1}{2}$  times that of copper; its resistance  $5\frac{5}{9}$  as great. What length of platinum wire weighing 100 grains has the same resistance as 100 inches of copper wire also weighing 100 grains? *Ans.* 27.

209. A cell with a resistance of an ohm is connected by very short thick wires, with the binding screws of a tangent galvanometer, the resistance of which is half an ohm, and the deflection is  $45^{\circ}$ ; if the screws be also connected at the same time by a wire of 1 ohm resistance, find the deflection. *Ans.*  $36^{\circ}52'$ .

210. The resistance of a galvanometer is half an ohm, and the deflection when the current of a cell is passed through it is  $30^{\circ}$ . When a wire of 2 ohms resistance is introduced into the circuit the deflection is  $15^{\circ}$ ; find the internal resistance of the cell. *Ans.* 1.23.

211. When the current of a cell, the resistance of which is  $\frac{1}{2}$  of an ohm, is passed through a galvanometer connected with it by very short thick wires, the deflection is  $45^{\circ}$ ; when the binding screws are also connected by a shunt having a resistance of 1 the deflection is  $33^{\circ}42'$ . Find the resistance of the galvanometer. *Ans.* 2.

212. A cell whose internal resistance is 2 ohms has its copper pole connected with the binding screw A of a galvanometer formed of a thick band of copper. From the other screw B a wire of 20 ohms resistance passes to the zinc pole, and the deflection read off is  $7^{\circ}8'$ . Find the deflection when B is at the same time connected with the zinc pole by a second wire of 30 ohms resistance. *Ans.*  $11.6'$ .

213. What would be the deflection in 185 if the second wire instead of passing from B to the zinc pole passed directly from the zinc pole to the copper pole? *Ans.*  $6^{\circ}43'$ .

214. A Leclanché cell deflects a galvanometer  $30^{\circ}$  when 200 ohms resistance are introduced into the circuit,  $15^{\circ}$  when 570 ohms are introduced; a standard Daniell cell deflects it  $30^{\circ}$  when 100 ohms are in circuit and  $15^{\circ}$  when 250 additional ohms are

introduced. Required the electromotive force of the Leclanché in terms of that of the Daniell. *Ans.* 1·48.

215. A Bunsen and a Daniell cell are placed in the same circuit in the first case so that the carbon of the first is united to the zinc of the Daniell; and in the second case so that their currents oppose each other. The currents are respectively  $30^{\circ}2$ , and in the second  $10^{\circ}6$ . Required the electromotive force of the Bunsen in terms of the Daniell. *Ans.* 1·89.

216. A telegraph line constructed of copper wire, a kilometre of which weighs 30·5 kilogrammes, is to be replaced by iron wire a kilometre of which weighs 135·6 kilogrammes. In what ratio does the resistance alter? *Ans.* The resistance of the iron wire will be 1·18 times that of the copper wire for which it is substituted.

217. A telegraph line which has previously consisted of copper wire weighing 30·5 kilogrammes to the kilometre is to be replaced by an iron wire of the same diameter which shall offer the same resistance. What must be the section of the latter, and what its weight per kilometre?

*Ans.* The section of the copper wire is 3·4357 sq. mm., that of the iron by which it is replaced is 20·6 sq. mm., and its weight per kilometre is 160·4 kilogrammes.

# INDEX.

(THE NUMBERS REFER TO THE ARTICLES.)

## ABE

**A**BEL'S electrical fuse, 769  
Aberration, chromatic, 565 ;  
spherical, 519  
Absolute expansion of mercury, 312  
Absolute measure of electrical resistance,  
910  
Absorbent power of aqueous vapour, 936  
Absorbing power, 412  
Absorption, 144 ; of gases, 145 ; of gases  
by liquids, 182 ; of heat by liquids,  
422 ; by vapours, 423 ; heat produced  
by, 468  
Acceleration of a force, 27, 78  
Accidental haloes, 609 ; images, 608 ;  
magnetic variations, 676  
Accommodation (of the eye), 602  
Achromatism, 566 ; of the microscope,  
574  
Achromatopsy, 614  
Acidometer, 127  
Acierage, 830  
Acclinic lines, 680  
Acoustics, 216-283  
Acoustic foci, 232 ; attraction and re-  
pulsion, 283  
Actinic rays, 424, 557  
Action and reaction, 39  
Adhesion, 87  
Aerial meteors, 927  
Aerolites, 466  
Esculine, 564  
Affinity, 86  
Agents, 6  
Agonic line, 674  
Air, aspirating action of currents of, 194 ;  
causes which modify temperature of,  
956 ; heating by, 477 ; thermometer,  
323 ; resistance of, 48  
Air balloons, 184 ; chamber, 204  
Air-pump, 454 ; Bianchi's, 191 ; con-  
densing, 188 ; Deleuil's, 192 ; gauges,

## AQU

189 ; rarefaction in, 188 ; receiver of,  
188 ; Sprengel's, 193 ; uses of, 197  
Ajutage, 211  
Alarum, electric, 865  
Alcarrazas, 362  
Alcoholic value of wines, 367  
Alcoholometer, 129 ; Gay-Lussac's, 129 ;  
centesimal, 129  
Alcohol thermometer, 296  
Alloys, 332  
Amalgam, 731  
Amalgamated zinc, 792  
Amber, 704  
Amici's microscope, 573 ; camera lucida,  
585  
Ampère's *memoria technica*, 796 ; theory  
of magnetism, 852  
Amplitude of vibration, 55  
Analogous pole, 713  
Analyser, 638  
Analysis, spectral, 559 ; of solar light,  
418  
Anelectrics, 705, 725  
Anelectrotonus, 804  
Anemometer, 927  
Aneroid barometer, 180  
Angle of deviation, 530 ; optic, 599 ; of  
polarisation, 636 ; reflection and inci-  
dence, 497, 522 ; of repose, 39 ; re-  
fraction, 522 ; visual, 599  
Angular currents, laws of, 833  
Animal heat, 471  
Anione, 816  
Annealing, 91  
Annual variations, 675  
Anode, 816  
Antilogous pole, 713  
Anvil, 888  
Aqueous humour, 594  
Aqueous vapour, its influence on climate,  
936 ; tension of, 344, 345, 346



## ARA

- Arago's experiment, 174  
 Arbor Dianæ, 826; Saturni, 826  
 Arc of vibration, 55; voltaic, 809  
 Archimedes' principle, 114; applied to gases, 183  
 Area, unit of, 22  
 Armatures, 700; Siemens', 883  
 Arms of levers, 40  
 Armstrong's hydro-electric machine, 735  
 Artesian wells, 112  
 Artificial magnets, 662  
 Ascent of liquids in capillary tubes, 133; between surfaces, 134  
 Astatic currents, 846; needle and system, 682  
 Astronomical telescope, 577  
 Athermancy, 422  
 Atmosphere, its composition, 151; crushing force of, 153; amount of, determination of, 157; electricity in the, 944, 945; moisture of, 388  
 Atmospheric electricity, causes of, 943, 946; pressure, 152, 926  
 Atomic heat, 445; weight deduced from specific heat, 445  
 Atoms, 3  
 Attraction, capillary, 135; and repulsion produced by capillarity, 135; molecular, 84; universal, 67  
 Attractions, magnetic, laws of, 685; electrical, laws of, 714  
 Atwood's machine, 78  
 Aura, 742  
 Aurora borealis, 676, 954  
 Aurum musivum, 731  
 Austral pole, 671  
 Avoirdupois, 23  
 Axis of crystal, 622; electric, 713; lenses, 537; optic, 599; of a magnet, 663; of oscillation, 80; visual, 943  
 Azimuthal circle, 677

**B**ABINET'S stopcock, 190

- Bad conductors, 392  
 Bain's electrochemical telegraph, 863  
 Balance, 72; beam of, 73; compensating, 310; delicacy of, 74; hydrostatic, 121; knife edge of, 72; physical and chemical, 75; torsion, 90, 686, 714  
 Ballistic pendulum, 82  
 Balloons, 184-187; construction and management of, 185; Mongolfier, 184  
 Bands of spectrum, 560  
 Barker's mill, 213

## BOI

- Barometers, 158; aneroid, 180; Buntzen's, 161; cistern, 159; corrections in, 164; determination of heights by, 171; fixed, 169; Fortin's, 160, Gay-Lussac's, 161; glycerine, 170; precautions with, 162; wheel, 168; variations of height of, 165  
 Barometric formula, Laplace's, 171; height of, corrected for heat, 317; manometer, 179; variations, 166  
 Baroscope, 183  
 Battery, Bunsen's, 786; Callan's, 786; chemical effects of, 815; Daniell's, 784; electric, 752; gas, 823; gravity, 788; Grove's, 785; Leclanché's, 789; Leyden, constant, 783; charged by coil, 889; local, 850; luminous effects, 809; magnetic, 699; measurement of charge, 755; mechanical effects of, 814; Menotti's, 788; Marié Davy's, 788; postal, 850; Smee's, 787; sulphate of mercury, 788; tension of, 791; thermo-electric, 901; voltaic, 780, 781; Walker's, 787; Wollaston's, 781  
 Beam of a balance, 73; of a steam-engine, 454  
 Beats, 255  
 Beaumé's hydrometer, 128  
 Becquerel's pyrometer, 906; thermo-electric battery, 901; electrical thermometer, 905  
 Bell of a trumpet, 232  
 Bellows, 238; hydrostatic, 102  
 Bennett's electroscope, 728  
 Berthollet's experiment, 181  
 Bertin's commutator, 843  
 Bertsch's machine, 737  
 Bianchi's air-pump, 191  
 Biaxial crystals, double refraction in, 626; optic axis of, 626; rings in, 649  
 Bifurcation, 621  
 Binnacle, 679  
 Binocular vision, 603  
 Biot's apparatus, 658  
 Black's experiments on latent heat, 448  
 Bladder, swimming, 119  
 Block and tackle, 45  
 Blood-globules, 15  
 Bodies, properties of, 7, 123  
 Bohnenberger's electroscope, 794  
 Boiler, 453  
 Boiling, 339; by cooling, 356; laws of, 352  
 Boiling point, influence of dissolved substances on, 354; of nature of vessel, 355; of pressure on, 356; in a ther-

## BOR

mometer, 292 ; measure of heights by, 358  
 Boreal pole, 671  
 Boutigny's experiments, 373  
 Boyle's law, 173-175  
 Bramah's hydraulic press, 109  
 Breaking weight, 92  
 Breezes, land and sea, 929  
 Breguet's thermometer, 299  
 Bridge, Wheatstone's, 912  
 British imperial yard, 22 ; and French system of weights and measures, 126  
 Browning's regulator, 812  
 Brush discharge, 762  
 Bull's eye, 573  
 Bunsen's battery, 787 ; burner, 560 ; ice calorimeter, 439 ; photometer, 495  
 Bunsen and Kirchhoff's researches, 561  
 Bunten's barometer, 161  
 Buoyancy of liquids, 101  
 Burning mirrors, 408

## CÆSIUM, 561

Cagniard-Latour's syren, 237 ; experiments on formation of vapour, 359  
 Callan's battery, 787  
 Calorescence, 421  
 Caloric, 435  
 Caloric effects of electrical discharge, 765 ; of current electricity, 805, 806 ; of Ruhmkorff's coil, 889 ; of the spectrum, 557  
 Calorimeter, 437 ; Bunsen's ice, 438 ; Black's, 438 ; Favre and Silbermann's, 450 ; Lavoisier and Laplace's, 438  
 Calorimetry, 434  
 Camera lucida, 576 ; Amici's, 585 ; obscura, 584 ; Porta's obscura, 500  
 Campani's eye-piece, 574  
 Capacity, specific inductive, 725  
 Capillarity, 132 ; attraction and repulsion produced by, 135 ; correction for, 163  
 Capillary phenomena, 132-139 ; tubes, 133 ; ascent and depression in, 133 ; between parallel or inclined surfaces, 134  
 Capsule, of the eye, 594  
 Cardan's suspension, 160  
 Carré's mode of freezing, 363 ; dielectric machine, 738  
 Carriage lamps, 521  
 Cartesian diver, 117  
 Cascade, charging by, 754  
 Cathetometer, 89

## COI

Catoptric telescopes, 580  
 Caustics, 519, 520  
 Celsius' scale, 293  
 Centesimal alcoholometer, 129  
 Centigrade scale, 293  
 Centimetre, 126  
 Centre, optical, 541 ; of gravity, 69 ; of parallel forces, 37 ; of pressure, 103  
 Charge of a Leyden jar, penetration of, 751 ; measurement of, 755 ; laws of, 756 ; residual, 751  
 Charging by cascade, 754  
 Chatterton's compound, 857  
 Chemical affinity, 86 ; combination, 469 ; effects of the battery, 768 ; of electrical discharge, 768 ; of voltaic currents, 797 ; of Ruhmkorff's coil, 889 ; harmonicon, 271 ; hygrometer, 382 ; properties of the spectrum, 557  
 Chemistry, 1  
 Chevallier's microscope, 573  
 Cheval-vapeur, 460  
 Chimes, electrical, 741  
 Chimney, 473  
 Chladni's experiments, 277  
 Chlorophylle, 563  
 Chords, major and minor, 242 ; physical constitution of, 257 ; tones dominant and subdominant, 243 ; vocal, 254  
 Choroid, 594  
 Chromatic scale, 245 ; aberration, 565  
 Chromium, magnetic limit of, 702  
 Ciliary processes, 594  
 Circle, azimuthal, 677  
 Circular polarisation, 651  
 Cirrocumulus, 932  
 Cirrostratus, 932  
 Cirrus, 932  
 Cistern barometer, 159  
 Clamond's thermo-electric battery, 902  
 Clarke's magneto-electrical machine, 880  
 Cleavage, electricity produced by, 712  
 Clement and Desorme's experiment, 194  
 Climate, 959 ; constant, 959 ; influence of aqueous vapour on, 936  
 Climatology, 954-961  
 Clocks, 82 ; electrical, 866  
 Clouds, 932 ; electricity of, 947 ; formation of, 933  
 Coatings, 747 ; Leyden jar with movable, 749  
 Cobalt, 702  
 Coercive force, 669  
 Coefficients of linear expansion, 303, 305, 306  
 Cohesion, 85  
 Coil, primary, 852 ; Ruhmkorff's, 887 ;

## COL

- effects produced by, 889; secondary, 852
- Cold, apparent reflection of, 410; produced by evaporation, 362; expansion of gases, 480; by nocturnal radiation, 481; sources of, 479
- Colladon and Sturm's experiments, 230
- Collecting plate, 757
- Collimation, 577
- Collision of bodies, 59
- Colloids, 141
- Coloration produced by rotatory polarisation, 657
- Colour, 7; of bodies, 574; of heat, 424; of thin plates, 632
- Colour disease, 614
- Colours, contrast of, 609; mixed, 555; simple, 551; complementary, 555; produced by polarised light, 644-650; by compressed glass, 650
- Combustion, 469; heat disengaged during, 470
- Comma, musical, 243
- Common reservoir, 707
- Communicator, 857
- Commutator, 858, 860, 881, 888; Bertin's, 843
- Compass, correction of errors, 678; declination, 677; mariner's, 679; inclination, 680; sine, 800; tangent, 799
- Compensating cube, 426
- Compensation pendulum, 310; balance, 310; gridiron, 310; strips, 310
- Complementary colours, 555
- Component forces, 32
- Composition of velocities, 52
- Compound microscope, 56
- Compressed glass, colours produced by, 650
- Compressibility, 7, 16; of gases, 173; of liquids, 96
- Concave mirrors, 407, 514
- Concert pitch, 246
- Concordant tones, 242
- Condensation of vapours, 364
- Condensed gas, 145; wave, 221
- Condenser, 454, 736, 743; limits to charge of, 746; of Ruhmkorff's coil, 888; Liebig's, 366
- Condensing engine, 459; air pump, 196; force, calculation of, 745; electro-scope, 759; plate, 759; hygrometers, 383
- Conduction of heat, 391; of electricity, 706; lightning, 952
- Conductivity of bodies for heat, 392; coefficient of, 392, 393; of gases, 397;

## CUR

- of liquids, 395; for electricity, 911, 914
- Conductors, 706; equivalent, 911; good and bad, 392; lightning, 952; prime, 730; resistance of, 909
- Congelation, 332
- Conical pendulum, 57
- Conjugate mirrors, 408; focus, 511, 538
- Connecting rod, 454
- Conservation of energy, 66
- Constant currents, 783
- Contact theory of electricity, 774
- Contractile force, 309
- Convection, 396
- Convex meniscus, 132; mirrors, 512, 515
- Cooling, method of, 442; Newton's law of, 405
- Cornea, 594
- Corpuscular theory, 485
- Corti's fibres, 254
- Cosine, law of the, 402, 494
- Coulomb's law, 685
- Couple, 36; terrestrial magnetic, 672; voltaic, 777; thermo-electric, 899
- Couronne des tasses, 781
- Coxwell's balloon, 184
- Crab, 42
- Critical angle, 526; temperature, 359
- Cross-wire, 577
- Crutch of a clock, 82
- Cryohydrate, 337
- Cryophorus, 362
- Crystal, hemihedral, 713
- Crystalline, 594
- Crystallisation, 333
- Crystalloids, 141
- Crystals, 333; expansion of, 305; doubly refracting, 621, 634, 645; uniaxial, 624; positive and negative, 625
- Cube, Leslie's, 411
- Cumulostratus, 932
- Cumulus, 932
- Current electricity, 776
- Currents, action on currents, 835, 836; action of magnets, 839; action of earth on, 845, 846; action on solenoids; 847, 852; constant, 783; derived, 917; detection and measurement of voltaic, 795; diaphragm, 814; direct and inverse, 876; effects of enfeeblement of, 782; extra, 875, 876; of inclination, 919; intensity of, 801; induction by, 868; laws of angular, 833; laws of sinuous, 834; local, 792; magnetisation by, 844; motion and sounds produced by, 856; muscular,

## CUR

918; rotation of magnets by, 829; secondary, 782; terrestrial, 853; thermal effects of, 806, 807; transmissions by, 818  
 Curvature of liquid surfaces, 136; influence of, on capillary phenomena, 137  
 Curves, magnetic, 686  
 Cushions, 730  
 Cyanogen gas, 369  
 Cylinder, 454; electrical machine, 734

**D**AGUERRETYPE, 590  
 Daltonism, 614  
 Dalton's laws on gases and vapours, 371; method of determining the tension of aqueous vapour, 345  
 Damper, 272, 873  
 Daniell's battery, 784; hygrometer, 384; pyrometer, 301  
 Dark lines of the spectrum, 557; of solar spectrum, 562  
 Davy's battery, 788  
 Davy's experiment, 409  
 Day, apparent, 21  
 Decimetre, 24, 126  
 Declination, compass, 677; magnetic, 673; of needle, 673; variations in, 674; of a star, 582  
 Decomposition, chemical, 815; of white light, 549; of salts, 817  
 Deflagrator, Hare's, 781, 805  
 Degrees of a thermometer, 293  
 De la Rive's floating battery, 840; experiments, 892  
 Deleuil's air-pump, 192  
 Delezenne's circle, 874  
 Delicacy of balance, 74; of thermometer, 297  
 Densimeter, 131  
 Density, 24; of the earth, 68; electric, 716; of gases, 324-326; maximum of water, 319; of vapours, Gay-Lussac's method, 374; Dumas's, 376; Deville and Troost's, 377; Hofmann's, 375  
 Depolarisation, 647  
 Depolarising plate, 645  
 Depression of liquids in capillary tube, 133; between surfaces, 134  
 Derived currents, 917  
 Descartes' laws of refraction, 523  
 Despretz's experiment, 392  
 Developer, 591  
 Deviation, angle of, 530  
 Deville and Troost's method, 377  
 Dew, 938; point, 383  
 Diabetic urine, analysis of, 660

## DUL

Dial telegraphs, 859  
 Dialyser, 141  
 Dialysis, 141  
 Diamagnetism, 895  
 Diapason, 252  
 Diaphanous bodies, 486  
 Diaphragm, 573; currents, 814  
 Diathermancy, 422  
 Dielectrical machine, Carré's, 738  
 Dielectrics, 725  
 Differential barometer, 179  
 Differential galvanometer, 797; thermometer, Leslie's, 298; Matthiessen's, 298; tone, 256  
 Diffraction, 489, 630; fringes, 628  
 Diffusion of heat, 425; of liquids, 141  
 Digester, Papin's, 360  
 Dioncea muscipula, 803  
 Dioptric telescopes, 580  
 Diplopy, 613  
 Dip, magnetic, 680  
 Dipping needle, 680  
 Discharge, electrical, 744; effects of the, 759; lateral, 952; slow and instantaneous, 744; universal, 759  
 Discharging rod, 744  
 Disc, Newton's, 552  
 Dispersion, 530  
 Dispersive power, 549  
 Displacement, 46  
 Dissipation of energy, 484  
 Distance, estimation of, 600; adaptation of eye to, 602  
 Distillation, 365  
 Distribution of free electricity, 715; of magnetism, 703; of temperature, 960; of land and water, 962  
 Diurnal variations, 675  
 Diver, Cartesian, 117  
 Dividing machine, 11  
 Divisibility, 7, 12  
 Döbereiner's lamp, 468  
 Dominant chords, 243  
 Doppler's principle, 229  
 Double-action steam-engine, 454, 455  
 Double refraction, 634  
 Doublet, Wollaston's, 568  
 Dove's law of storms, 930  
 Draught of fire-places, 474  
 Driving wheels, 457  
 Drummond's light, 588  
 Dry piles, 793  
 Duboscq's microscope, 588; regulator, 811  
 Ductility, 7, 93  
 Duhamel's graphic method, 240  
 Dulong and Arago's experiments on

## DUL

- Boyle's law, 174; method of determining the tension of aqueous vapour, 346  
 Dulong and Petit's determination of absolute expansion of mercury, 312  
 Dulong and Petit's method of cooling, 442; law, 445  
 Dumas's method for vapour density, 376  
 Duplex telegraphy, 862  
 Duration of electrical spark, 770  
 Dutochet's endosmometer, 140  
 Dynamical theory of heat, 417  
 Dynamic radiation and absorption, 430  
 Dynamo-magnetic machine, 885

**EARTH**, its action on currents, 844-846; action of solenoids, 851; flattening of, by rotation, 83; magnetic poles of the, 680; magnetisation by, 696

- Earth's magnetism, 683  
 Earnshaw on velocity of sound, 226  
 Ear trumpet, 234  
 Ebullition, 339; laws of, 352  
 Eccentric, 454, 455  
 Echelon lenses, 589  
 Echoes, 232; monosyllabic, trisyllabic, multiple, 232  
 Efflux, velocity of, 208; quantity of, 210; influence of tubes on, 211  
 Effusion of gases, 143  
 Elastic bodies, 59  
 Elastic force, 146; of vapours, 340  
 Elasticity, 7, 17; limit of, 17, 89; of traction, 89; modulus of, 89; of torsion, 90; of flexure, 91  
 Electrical machines, 729-738; precautions in, 731  
 Electrical attractions and repulsions, 714; resistance, unit of, 910; conductivity, 914  
 Electric alarm, 865; axis, 713; batteries, bottle, 764, 752; charge, 756; chimes, 741; clocks, 866; density, 716; discharge, 759; egg, 763; fish, 923; fuse, 769; glow, 762; light, 807-809; stratification of the, 890; pendulum, 705; pistol, 768; poles, 713; residue, 751; shock, 748, 760; spark, 740; telegraphs, 857-867; whirl, 742; tube, 764  
 Electricity, 6, 704; application of, to medicine, 924; atmospheric, 943-952; current, 776; bodies in contact, 718; communication of, 726; development of, by friction, 711; by

## EQU

- pressure and cleavage, 712; distribution of, 715; dynamical, 772-917; disengagement of, in chemical actions, 768, 774; frictional, 711; loss of, 719; mechanical effects, 767; produced by induction, 721; velocity of, 771; theories of, 709  
 Electrified bodies, motion of, 710, 727  
 Electro-capillary phenomena, 814a  
 Electrochemical telegraph, 863; series, 816  
 Electrodes, 779; polarisation of, 782  
 Electrodynamics, 831  
 Electroforming, 828  
 Electrolysis, 816; laws of, 820  
 Electrolyte, 816  
 Electromagnetic force, 855; machines, 867  
 Electromagnets, 855  
 Electrometallurgy, 827-829  
 Electrometer, 728; Lane's, 755; quadrant, 733; Thomson's, 758  
 Electromotor, 857  
 Electromotive series, 777; force, 778, 790, 801, 915; determination of, 915; force of elements, 790  
 Electrophorus, 729  
 Electroprometer, 906  
 Electroscopes, 705; Bohnenberger's, 794; Volta's condensing, 757; gold leaf, 728  
 Electrosilvering, 829  
 Electrotonus, 804  
 Elements, electronegative and electropositive, 816  
 Elliptical polarisation, 654  
 Emergent rays, 528  
 Emission theory, 485  
 Emissive power, 413  
 Endosmometer, 136  
 Endosmose, 140; electrical, 814; of gases, 142  
 Endosmotic equivalent, 140  
 Energy, 63; conservation of, 66; dissipation of, 484; transformations of, 65; varieties of, 64  
 Engines, gas, 462; steam, 452; double action, 454; low and high pressure, 459; single action, 456; locomotive, 441; fire, 206; transformation of, 65  
 Eolipyle, 458  
 Equator, 663; magnetic, 680  
 Equilibrium of forces, 35; of floating bodies, 116; of heavy bodies, 70; of liquids, 107-108; mobile of temperature, 402; neutral, 71; stable, 71; unstable, 71  
 Equivalent, endosmotic, 140; conductors, 911

## ESC

Escapement, 82; wheel, 82  
 Ether, 417; luminiferous, 485  
 Evaporation, 339; causes which accelerate it, 351; cold due to, 362; latent heat of, 361  
 Evaporation and ebullition, 353  
 Exchanges, theory of, 403  
 Exhaustion, produced by air-pump, 191; by Sprengel's pump, 193  
 Exosmose, 140  
 Expanded wave, 221  
 Expansibility of gases, 146  
 Expansion, 286; apparent and real, 311; absolute, of mercury, 312; apparent, of mercury, 313; of liquids, 316; of solids, 303; of gases, 320-322; linear and cubical, coefficients of, 303; measurement of linear, 304; of crystals, 308; applications of, 309; force of, 318  
 Expansion of gases, cold produced by, 480; problems on, 321  
 Expansive force of ice, 335  
 Experiment, Berthollet's, 181; Franklin's, 357; Florentine, 98; Pascal's, 156; Torricellian, 155  
 Extension, 7, 9  
 Extra current, 875, 876; direct, 876; inverse, 876  
 Eye, 594; accommodation of, 602; not achromatic, 610; refractive indices of media of, 595; path of rays in, 597; dimensions of various parts of, 596  
 Eye-glass, 530, 612; lens, 574; piece, 565, 572, 574; Campani's, 574

**F**AHRENHEIT'S hydrometer, 124; scale, 293

Falling bodies, laws of, 77

Faraday's experiments, 722; wheel, 607; theory of induction, 724; voltameter, 820

Favre and Silbermann's calorimeter, 450; determination of heat of combustion, 469

Field of a microscope, 573; of view, 575; magnetic, 689

Field lens and glass, 574; of microscope, 573

Figures, Lichtenberg's, 750

Finder, 577

Fire engine, 206; places, 473; works, 213

Fish, electrical, 923

Fishes, swimming bladder of, 118

Fizeau's experiments, 306, 493

## FRI

Flame, 469

Flask, specific gravity, 122

Flattening of the earth, 83

Flexure, elasticity of, 91

Float, 453

Floating bodies, 116

Florentine experiment, 13, 98

Fluid, 4; imponderable, 6; elastic, 149; magnetic, 665

Fluidity, 7

Fluorescence, 564

Flute, 273

Fluxes, 329

Fly-wheel, 454

Focal distance, 407

Foci, acoustic, 232; of convex mirrors, 512; in double convex lenses, 538

Focus, 407, 511; conjugate, determination of the principal, 513; of a spherical concave mirror, 511

Focussing the microscope, 569

Fogs, 931

Foot, 22

Foot-pound, 60, 460

Force, 26; conservation of, 66; coercive, 669; direction of, 30; elastic, 0 gases, 146; lines of magnetic, 689; of expansion and contraction, 309; electromotive, 778, 790; representation of, 30; parallelogram of, 33; of liquids, 318; portative, 701

Forces, 6; along the same line, 31; equilibrium of, 38; impulsive, 61; magnetic, 680; molecular, 84; moments of, 38; polygon of, 35; triangle of, 35

Formulae for expansion, 308; barometric, 168; for sound, 227, for spherical mirrors, 516, 517; for lenses, 545

Fortin's barometer, 160

Foucault's determination of velocity of light, 492; experiment, 810

Fountain in vacuo, 197; at Giggleswick, 201; intermittent, 199; Hero's, 198

Franklin's experiment, 357, 943; plate, 747; theory of electricity, 709

Fraunhofer's lines, 558, 559

Freezing, apparatus for, 363

Freezing mixtures, 336, 337; point in a thermometer, 292

French weights and measures, 124; boiler, 453

Fresnel's experimentum crucis, 627; rhomb, 653

Friction, 26, 47; heat of, 463; hydraulic, 211; development of electricity by, 711

## FRI

Friction wheels, 78  
 Frigorific rays, 410  
 Fringes, 628  
 Frog, rheoscopic, 920  
 Frost, 928  
 Frozen mercury, 362, 369, 373  
 Fulcrum, 44  
 Fulgurites, 950  
 Fulminating pane, 747  
 Fuse, Abel's, 769; Chatham, 805, 806  
 Fusing point, 327  
 Fusion, laws of, 327; vitreous, 327;  
 latent heat of, 448; of ice, 437

**G**ALILEAN telescope, 579  
 Galleries, whispering, 232  
 Gallon, 126  
 Galvani's experiment, 772  
 Galvanometer, 797; differential, 797;  
 Sir W. Thomson's, 798  
 Galvanoscope, 797  
 Galvanothermometer, 806  
 Gas battery, 823; engines, 462  
 Gases, absorption of, by liquids, 182;  
 application of Archimedes' principle  
 to, 183; cold produced by expansion  
 of, 480; compressibility of, 148, 173;  
 conductivity of, 397; diamagnetism  
 of, 894; density of, 324, 326; expan-  
 sion of, 147, 320-323; endosmose of,  
 142; effusion and transpiration of,  
 143; Gay-Lussac's method, 320;  
 index of refraction of, 536; laws of  
 mixture of, 181; and vapours, mix-  
 tures of, 371; permanent, 369; pro-  
 blems in, 372; liquefaction of, 369;  
 physical properties of, 146; pressure  
 exerted by, 150; radiation of, 429;  
 Regnault's method, 325; specific heat  
 of, 447; velocity of sound in, 226,  
 227, 228; weight of, 149  
 Gaseous state, 4  
 Gassiot's battery, 791  
 Gauge, air-pump, 189; rain, 934  
 Gay-Lussac's alcoholometer, 129; baro-  
 meter, 161; determination and expan-  
 sion of gases, 320; of vapour-density,  
 374; stopcock, 371  
 Geissler's tubes, 193, 561 891  
 Generating plate, 777  
 Geographical meridian, 673  
 Geometrical shadows, 489  
 Giffard's injector, 194  
 Gimbals, 679  
 Glacial pole, 960  
 Glaciers, 942

## HEA

Glashier's balloon ascents, 184; factors,  
 386  
 Glass, expansion of, 315; magnifying,  
 565; object, 572; opera, 579  
 Glasses, periscopic, 611; weather, 168  
 Globe lightning, 950  
 Glow, electrical, 762  
 Glycerine barometer, 170  
 Gold-leaf electroscope, 728  
 Goniometers, 520  
 Good conductors, 392  
 Gramme, 24, 126  
 Gramme's magneto-electrical machine,  
 886  
 Graphic method, Duhamel's, 240; Fos-  
 ter's, 807  
 Gratings, 629  
 Gravesande's ring, 285  
 Gravitation, 6, 83; terrestrial, 68; ac-  
 celerative effect of, 27  
 Gravity, battery, 788  
 Gravity, centre of, 69  
 Gregorian telescope, 581  
 Gridiron pendulum, 310  
 Grimaldi's experiment, 627  
 Grothhuss' hypothesis, 819  
 Grove's battery, 785; gas, 823  
 Guericke's air-pump, 188  
 Gulf Stream, 957  
 Guthrie's researches, 337

**H**ADLEY'S reflecting sextant, 507  
 Hail, 940

Hair hygrometer, 387  
 Haldat's apparatus, 102  
 Hallström's experiments, 319  
 Haloes, 609  
 Hammer, 272, 888  
 Hardening, 91  
 Hardness, 7; scale of, 94  
 Hare's deflagrator, 781, 805, 806  
 Harmonicon, chemical, 271  
 Harmonics, 249, 266  
 Harmonic triad, 242; grave, 256  
 Harp, 274  
 Harris's unit jar, 756  
 Heat, 284; animal, 471; absorption of,  
 by vapours, &c., 423, 427; diffusion  
 of, 425; developed by induction, 893;  
 dynamical theory of, 417; hypothesis  
 on, 284; influence of the nature of,  
 423; latent, 330; mechanical, equi-  
 valent of, 483; polarisation of, 661;  
 produced by absorption and imbibition,  
 468; radiated, 391; radiant,  
 399; reflection of, 406; scattered,

## HEA

412; sources of, 463-482; specific, 435; transmission of, 391; terrestrial, 467  
 Heaters, 453  
 Heating, 472; by steam, 476; by hot air, 477; by hot water, 478  
 Height of barometer, 159, 165; variations in, 165  
 Heights of places, determination of, by barometer, 171, 172; by boiling point, 358  
 Heliograph, 509  
 Heliostat, 520  
 Helix, 45, 854  
 Helmholtz's analysis of sound, 250; researches, 253  
 Hemihedral crystal, 713  
 Hemispheres, Magdeburg, 154  
 Henley's electrometer, 733; discharger, 767  
 Henry's experiment, 877  
 Herepath's salt, 640  
 Hero's fountain, 198  
 Herschelian rays, 418; telescope, 583  
 Hirn's experiments, 461  
 Hoar frost, 938  
 Hofmann's, density of vapours, 375  
 Holmes' magneto-electrical machine, 882  
 Holtz's electrical machine, 736  
 Homogeneous light, 556; medium, 488  
 Hope's experiments, 319  
 Horizontal line, 68; plane, 68  
 Horse power, 460  
 Hotness, 287  
 Hour, 21  
 Howard's nomenclature of clouds, 932  
 Humour, aqueous, 594  
 Hyaloid membrane, 594  
 Hydraulic press, 109; friction, 211; tourniquet, 213  
 Hydraulics, 96  
 Hydrodynamics, 96  
 Hydro-electric machine, 735  
 Hydrometers, 120; Nicholson's 121; Fahrenheit's, 124; with variable volume, 127; Beaumé's, 128; of constant volume, 127; specific gravities, 120; uses of tables of, 126  
 Hydrostatic bellows, 102; paradox, 104; balance, 121  
 Hydrostatics, 96-99  
 Hydrometers, 381; of absorption, 387; chemical, 382; condensing, 383; wet-bulb, 386; Mason's, 386; Regnault's, 385  
 Hygrometric state, 380; substances, 379  
 Hygrometry, 379; problem on, 389

## INS

Hygroscope, 387  
 Hypothesis, 5  
 Hypsometer, 358  
 ICE, 941; method of fusion of, 437  
 Ice calorimeter, 437; Bunsen's, 438; expansive force of, 335; machine, 480  
 Iceland spar, 641  
 Idioelectrics, 705  
 Image and object, magnitudes of, 547  
 Images, accidental, 608; condition of distinctness of, 569; formation of, in concave mirrors, 514; in convex mirrors, 515; in plane mirrors, 499; of multiple, 502; magnitude of, 518; produced by small apertures, 490; virtual and real, 500; inversion of, 598  
 Imbibition, 144; heat produced by, 468  
 Impenetrability, 7  
 Imperial British yard, 22  
 Imponderable matter, 6  
 Impulsive forces, 58  
 Inch, 126  
 Incident ray, 522  
 Inclination, 680; compass, 681  
 Inclined plane, 43; motion on, 50  
 Index of refraction, 524; measurement of, in solids, 534; in liquids, 535; in gases, 536  
 Indicator, 857, 859, 860  
 Indices, refractive, table of, 536  
 Indium, 561  
 Induced currents, 868-880  
 Induction, apparatus founded on, 880  
 by the earth, 874; by currents, 868; of a current on itself, 875; electrical, 721; in telegraph cables, 861; limit to, 723; Faraday's theory of, 724; heat developed by, 893; by magnets, 872; magnetic, 668; vertical, 697  
 Inductive capacity, specific, 725  
 Inductorium, 887  
 Inelastic bodies, 59  
 Inertia, 19; applications of, 20  
 Influence, magnetic, 668; electrical, 721  
 Ingenhaus's experiment, 392  
 Injector, 194  
 Insects, sounds produced by, 237  
 Insolation, 617, 618  
 Instruments, optical, 567; polarising, 638; mouth, 263; reed, 265; stringed, 272; wind, 264, 273  
 Insulating bodies, 707; stool, 740  
 Insulators, 706



## INT

- Intensity of the current, 801; of the electric light, 813; illumination, 494; of reflected light, 505; of a musical tone, 241; of radiant heat, 402; of sound, causes which influence, 222; of terrestrial magnetism, 683; of terrestrial gravity, 83
- Interference of light, 627
- Intermittent fountain, 199; springs, 201; syphon, 201
- Interpolar, 801
- Intervals, musical, 242
- Intrapolar region, 804
- Inversion of images, 598
- Iones, 816
- Iris, 594
- Iron, passive state of, 824; electrical deposition of, 830
- Iron ships, magnetism of, 697
- Irradiation, 609
- Irregular reflection, 504
- Isochimenal line, 958
- Isoclinic lines, 680
- Isodynamic lines, 683
- Isogeothermic lines, 958
- Isogonic lines, 674
- Isothermal lines, 958
- Isothermal lines, 958; zone, 958

## JACOBI'S unit, 910

- Jar, Leyden, 748-758
- Jar, luminous, 764; Harris's unit, 755
- Jet, lateral, 208; height of, 209; form of, 212
- Jordan's barometer, 170
- Joule's experiment on heat and work, 483; equivalent, 483
- Jupiter, 491

## KALEIDOPHONE, 607

- Kaleidoscope, 502
- Kamsin, 929
- Kathode, 816
- Kathelectrotonus, 804
- Katione, 816
- Keepers, 700
- Key, 858, 874, 881, 888; note, 244
- Kienmayer's amalgam, 731
- Kilogramme, 24, 126
- Kilogrammetre, 460
- Kinetic energy, 63
- Kinnersley's thermometer, 767
- Kirk's Ice machine, 480
- Knife edge, 72

## LIG

- König's apparatus, 251; manometric flames, 281
- Kravogl's machine, 867
- Külp's method of compensation, 701
- Kundt's velocity of sound, 270

## LACTOMETER, 130

- Ladd's dynamomagnetic machine, 885
- Land and water, 962
- Lane's electrometer, 755
- Lantern, magic, 586
- Laplace's barometric formula, 171
- Laryngoscope, 548
- Latent heat, 330; of fusion, 448; of vapours, 361, 449
- Latitude, influence on the air, 956; parallel of, 83
- Lavoisier and Laplace's calorimeter, 437; method of determining linear expansion, 304
- Law, 5
- Lead tree, 826
- Leclanché's elements, 789, 790
- Ledger lines, 247
- Leidenfrost's phenomenon, 373
- Lemniscate, 649
- Length, unit of, 22; of undulation, 221
- Lenses, 537-545; achromatic, 564; aplanatic, 544; combination of, 546; foci in double convex, 538; in double concave, 539; formation of images in double convex, 542; in double concave, 543; formulæ relating to, 545; lighthouse, 589; optical centre, secondary axis of, 541
- Lenz's law, 870
- Leslie's cube, 411; experiment, 362; thermometer, 298
- Level, water, 110; spirit, 111
- Level surface, 68
- Levelling staff, 110
- Lever, 40
- Leyden discharge, inductive action of, 871
- Leyden jars, 748-758; charged by Ruhmkorff's coil, 889
- Lichtenberg's figures, 750
- Liebig's condenser, 366
- Ligament, suspensory, 594
- Light, 485; diffraction of, 628; homogeneous, 554, 556; intensity of, 494; interference of, 627; laws of reflection of, 497; medium, 488; oxyhydrogen, 588; polarisation of, 634; relative intensities of, 496; sources of, 616;

## LIG

- theory of polarised light, 643; undulatory theory of, 485, 619; velocity of, 491-493
- Lighthouse lenses, 589
- Lightning, 948; ascending, 950; effects of, 950; conductor, 952; globe, 950; heat, 948; brush, 948; flashes, 948; zigzag, 948
- Limit, magnetic, 702; to induction, 723; of perceptible sounds, 239
- Line, acclinic, 680; of collimation, 577; isoclinic, 680; agonic, 674; isogonic, 674; isodynamic, 683; of sight, 577
- Linear expansion, coefficients of, 303, 305
- Lippmann's capillary electrometer, 814a
- Liquefaction of gases, 369, 370; of vapours, 364
- Liquids, 100; active and inactive, 658; buoyancy of, 101; compressibility of, 98; conductivity of, 395; calculation of density of, 108; diffusion of, 141; diamagnetism of, 895; expansion of, 311; equilibrium of, 105; manner in which they are heated, 396; pressure on sides of vessel, 103; refraction of, 535; rotatory power of, 658; spheroidal form of, 85; spheroidal state of, 373; specific heat of, 443; volatile and fixed, 338; tensions of vapours of, 348; of mixed liquids, 349
- Lissajous' experiments, 277-279
- Lithium, 561
- Litre, 24, 126
- Local action, 782; attraction, 697; battery, 860; currents, 792
- Locatelli's lamp, 416
- Locomotives, 457, 458
- Lodestone, 662
- Long-sight, 611
- Loops and nodes, 262
- Loss of electricity in vacuo, 720; of weight in air, correction for, 390
- Loudness of a musical tone, 241
- Luminiferous ether, 485
- Luminous bodies, 486; effects of the electric discharge, 751, 809; of the electric current, 889; of Ruhmkorff's coil, 889; jar, 764; meteors, 943; pane, 764; pencil, 487; ray, 487; tube, 764; square, and bottle, 764
- Luminous radiation, 420; heat, 422

## MAS

- Mackerel sky, 932
- Magazine, 699
- Magdeburg hemispheres, 154
- Magic lantern, 586
- Magnetic attractions and repulsions, 684; battery, 699; couple, 672; curves, 688; declination, 677; dip, 680; effects of the electrical discharge, 766; equator, 680; field, 689; fluids, 665; induction, 668; influence, 668; limit, 702; meridian, 673; needle, 673, 674; observatories, 684; poles, 680; saturation, 698; storms, 676
- Magnetisation, 692; by the action of the earth, 696; by currents, 854
- Magnetism, 6, 682; determination of in absolute pressure, 691; earth's, 683; of iron ships, 697; Ampère's theory of, 852; remanent, 855; theory of, 665; terrestrial distribution of free, 703
- Magneto-electrical apparatus, 880; Gramme's 886; machines, 882-885
- Magnets, artificial and natural, 662; broken, 667; action of earth on, 671; equator of, 663; north and south poles of, 664; portable, force of, 701; saturation of, 698; influence of heat, 702; induction by, 872; inductive action on moving bodies, 873; action on currents, 840; on solenoids, 850; rotation of induced currents by, 892; optical effects of, 894; total action of two, 690
- Magnification, linear and superficial, 571; measure of, 571; of a telescope, 577
- Magnifying power, 576
- Magnitude, 9; apparent, of an object, 570; of images in mirrors, 569
- Major chord, 242; triads, 243
- Malleability, 832
- Mance's heliograph, 509
- Manganese, magnetic limit of, 702
- Manhole, 453
- Manipulator, 859
- Manometer, 98, 176; open-air, 177; with compressed air, 178; Regnault's barometric, 179
- Manometric flames, 281
- Mares' tails, 932
- Marié Davy battery, 788
- Marine galvanometer, 798
- Mariner's card, 927; compass, 679
- Mariotte and Boyle's law, 173
- Mariotte's tube, 173; bottle, 215
- Marloye's harp, 274
- Maskelyne's experiment, 68
- Mason's hygrometer, 386

**M**ACHINE, Atwood's, 78; electrical, 729-738; Von Ebner's, 769; electromagnetic, 857

- MAS
- Mass, measure of, 23 ; unit of, 23  
 Matter, 2  
 Matteucci's experiment, 871  
 Matthiessen's thermometer, 298  
 Maximum current, conditions of, 802  
 Maximum and minimum thermometers, 300 ; of tension, 732  
 Mean temperature, 955  
 Measure of force, 29 ; of work, 61  
 Measure of magnification, 571, 576 ; of mass, 23 ; of space, 22 ; of time, 21 ; of velocity, 25  
 Measurement of small angles by reflection, 508  
 Mechanical equivalent of heat, 483 ; effects of electrical discharge, 767  
 Melloni's researches, 417 ; thermomultiplier, 400, 903  
 Melting point, influence of pressure on, 328  
 Membranes, vibrations of, 276  
 Memoria technica, 796  
 Meniscus, 133 ; in barometer, 163 ; Sagitta of, 163  
 Menotti's battery, 788  
 Mercury frozen, 362, 370, 373 ; pendulum, 310 ; coefficient of expansion, 313 ; expansion of, 312 ; pump, 195  
 Meridian, 21 ; geographical and magnetic, 673  
 Metacentre, 116  
 Metal, Rose's and Wood's fusible, 329  
 Metals, conductivity of, 914  
 Meteoric stones, 466  
 Meteorograph, 926  
 Meteorology, 925  
 Metre, 22, 126  
 Mica, 646  
 Micrometer lines, 576 ; screw, 11  
 Microscope, 12 ; achromatism of, 574 ; Amici's, 573 ; compound, 572 ; focusing, 569 ; magnifying powers of, 576 ; photo-electric, 588 ; simple, 568 ; solar, 587  
 Microspectroscopy, 563  
 Mill, Barker's, 213  
 Millimetre, 126  
 Mineral waters, 951  
 Mines, firing by electricity, 769, 805  
 Minimum thermometer, 300 ; deviation, 533  
 Minor chord, 242  
 Minute, 21  
 Mirage, 527  
 Mirrors, applications of, 520 ; burning, 408 ; concave, 407 ; conjugate, 408 ; glass, 501 ; parabolic, 521 ; rotating, 506, 770 ; spherical, 510  
 Mists, 931  
 Mixture of gases, 181 ; of gases and liquids, 182  
 Mixtures, freezing, 336 ; method of, 439  
 Mobile equilibrium, 403  
 Mobility, 7, 18  
 Modulus of elasticity, 89  
 Moisture of the atmosphere, 388  
 Molecular forces, 3 ; attraction, 84 ; state of bodies, 4  
 Molecular state, relation of absorption to, 431  
 Molecules, 3  
 Moments of forces, 38  
 Momentum, 28  
 Mongolfier's balloon, 184  
 Monochord, 259  
 Monochromatic light, 554  
 Monosyllabic echo, 232  
 Morgagni's humour, 594  
 Morin's apparatus, 79  
 Morren's mercury pump, 195  
 Morse's telegraph, 860  
 Motion, 18 ; on an inclined plane, 50 ; curvilinear, 25 ; in a circle, 53, 54 ; rectilinear, 25 ; resistance to, in a fluid, 48 ; uniformly accelerated rectilinear, 48 ; quantity of, 29 ; of a pendulum, 55 ; of projectile, 51  
 Mouth instruments, 264  
 Multiple battery, 802  
 Multiple echoes, 232 ; images formed by mirrors, 501, 502, 503  
 Multiplier, 797  
 Muscular currents, 919, 920  
 Music, 213 ; physical theory of, 241-257  
 Musical boxes, 274 ; intervals, 242 ; scale, 243 ; temperament, 245 ; tones, properties of, 241 ; intensity, notation, 247 ; pitch, and timbre, 241 ; sound, 219 ; range, 247  
 Myopy, 601, 611
- NEW
- N**AIRNE'S electrical machine, 734  
 Nascent state, 86  
 Natterer's apparatus, 370  
 Needle, dipping, 680 ; astatic, 682 ; magnetic, 673  
 Negative plate, 777  
 Negatives on glass, 591  
 Nerve currents, 922  
 Neutral line, 721 ; equilibrium, 71 ; point, 721  
 Newtonian telescope, 582

## NEW

Newton's disc, 553 ; law of cooling, 404 ; rings, 632, 633 ; theory of light, 553  
 Nicholson's hydrometer, 121  
 Nickel, electrical deposition of, 830 ; magnetic limit of, 702  
 Nicol's prism, 642  
 Nimbus, 932  
 Nobili's battery, 900 ; rings, 825 ; thermomultipliers, 902 ; thermo-electric pile, 416, 419, 900  
 Nocturnal radiation, 481  
 Nodal points, 264, 627  
 Nodes and loops, 264 ; of an organ pipe, 267 ; explanation of, 269  
 Noises, 217  
 Nonconductors, 706  
 Norremberg's apparatus, 639  
 Northern light, 954  
 Norwegian stove, 398  
 Notation, musical, 247  
 Notes in music, 242 ; musical, of women and boys, 254 ; wave, length of, 248  
 Nut of a screw, 45

## OBJECT glass, 572

Objective, 572

(Obscure radiation, 420 ; rays, 421 ; transmutation of, 421  
 Observatories, magnetic, 684  
 Occlusion of gases, 145  
 Octave, 242  
 Oersted's experiment, 796  
 Ohm's law, 801  
 Opaque bodies, 486  
 Opera glasses, 579  
 Ophthalmoscope, 615  
 Optics, 485  
 Optic axis, 589 ; axis of biaxial crystals, 626 ; angle, 589 ; nerve, 594  
 Optical centre, 541 ; effects of magnets, 894 ; instruments, 567  
 Optometer, 601  
 Organ pipes, 267 ; nodes and loops of, 267  
 Orrery, electrical, 742  
 Oscillations, 55 ; axis of, 80 ; method of, 687  
 Otto von Guericke's air-pump, 188  
 Outcrop, 112  
 Overshot wheels, 214  
 Oxyhydrogen light, 588  
 Ozone, 768, 950

## PALLET, 82

Pane, fulminating, 747 ; luminous, 765

## PIT

Papin's digester, 360  
 Parabolic mirrors, 521 ; curve, 61, 208  
 Parachute, 186  
 Paradox, hydrostatic, 104  
 Parallel of latitude, 83 ; forces, 36 ; centre of, 27  
 Parallel rays, 487  
 Parallelogram of forces, 33  
 Paramagnetic bodies, 895  
 Partial current, 917  
 Pascal's law of equality of pressures, 99 ; experiments, 156  
 Passage tint, 659  
 Passive state of iron, 824  
 Pedal, 272  
 Peltier's cross, 907  
 Pendulum, 55 ; application to clocks, 82 ; ballistic, 82 ; conical, 57 ; compensation, 310 ; electrical, 680 ; grid-iron, 310 ; mercurial, 310 ; length of compound, 80 ; verification of, laws of, 81  
 Penumbra, 489  
 Percussion, heat due to, 465  
 Periscopic glasses, 611  
 Permanent gases, 369  
 Persistence of impression on the retina, 607  
 Perturbations, magnetic, 674, 675  
 Phenakistoscope, 607  
 Phenomenon, 5  
 Phial of four elements, 107  
 Phonautograph, 280  
 Phosphorescence, 617, 618  
 Phosphorogenic rays, 557  
 Phosphroscope, 618  
 Photo-electric microscope, 588  
 Photogenic-apparatus, 588  
 Photographs on paper, 591 ; on albumenised paper and glass, 593  
 Photography, 590-593  
 Photometers, 495, 497  
 Physical phenomena, 5 ; agents, 6 ; shadows, 489  
 Physics, object of, 1  
 Physiological effects of the electric discharge, 760 ; of the current, 803 ; of Ruhmkorff's coil, 889  
 Piezometer, 98  
 Pigment colours, 555  
 Pile, voltaic, 780-794  
 Pipes, organ, 257  
 Pisa, tower of, 70  
 Pistol, electric, 768  
 Piston of air-pump, 188 ; rod, 454  
 Pitch, concert, 246 ; of a note, 241 ; a screw, 45

## PLA

Plane, 45 ; electrical inclined, 742 ; wave, 624  
 Plants, absorption in, 144  
 Planté's secondary battery, 822  
 Plate electrical machine, 730  
 Plates, colours of thin, 632 ; vibrations of, 275  
 Plumb-line, 68  
 Pluviometer, 934  
 Pneumatic syringe, 148, 465  
 Poggendorff's law, 768  
 Point, boiling, 355, 356  
 Points, power of, 717  
 Polar aurora, 954  
 Polarisation, 822 ; angle of, 636 ; current, 822 ; of electrodes, 782 ; by double refraction, 634 ; by reflection, 635 ; by single refraction, 637 ; elliptical and circular, 651, 652, 654 ; of heat, 661 ; galvanic, 782, 822 ; of the medium, 724 ; plane of, 636 ; plate, 782 ; rotatory, 655  
 Polarised light, theory of, 643 ; colours produced by the interference of, 644, 650 ; rays, 644  
 Polariser, 638  
 Polarising instruments, 638  
 Polarity, 782 ; boreal, austral, 671  
 Poles, 779 ; analogous and antilogous, 816 ; of the earth, 680 ; of a magnet, 663 ; mutual action of, 664 ; precise definition of, 666 ; austral and boreal, 671  
 Polygon, of forces, 35  
 Polyprism, 530  
 Ponderable matter, 6  
 Pores, 13  
 Porosity, 7, 13 ; application of, 15  
 Portative force, 701  
 Positive plate, 777  
 Positives on glass, 592  
 Postal battery, 860  
 Potential energy, 63 ; of electricity, 775  
 Pound, 126 ; avoirdupois, 23, 29 ; foot, 60  
 Powders, radiation from, 431  
 Power of a lever, 40 ; of a microscope, 576  
 Presbyitism, 601, 611  
 Press, hydraulic, 109  
 Pressure, centre of, 103 ; on a body in a liquid, 113 ; atmospheric, 152 ; amount of, on human body, 157 ; experiment illustrating, 197 ; influence on melting point, 328 ; heat produced by, 465 ; electricity produced by, 712

## RAY

Pressures, equality of, 99 ; vertical downward, 100 ; vertical upward, 101 ; independent of form of vessel, 102 ; on the sides of vessels, 103  
 Prévost's theory, 403  
 Primary coil, 862  
 Primitive current, 917  
 Principal current, 917  
 Principle of Archimedes, 114  
 Prisms, 528-533 ; double refracting, 641 ; Nicol's, 642 ; with variable angle, 530  
 Problems on expansion of gases, 321 ; on mixtures of gases and vapours, 372 ; on hygrometry, 389  
 Projectile, motion of, 51  
 Proof plane, 715  
 Propagation of light, 488  
 Protoplasm, 803  
 Protuberances, 562  
 Pulley, 41  
 Pump, air, 188 ; condensing, 196  
 Pumps, different kinds of, 202 ; suction, 203 ; suction and force, 204  
 Pupil, 594  
 Psychrometer, 386  
 Pyrheliometer, 466  
 Pyroelectricity, 713  
 Pyrometers, 301 ; electric, 906

**Q**UADRANTAL deviation, 697  
 Quadrant electrometer, 733

**R**ADIANT heat, 501 ; detection and measurement of, 400 ; causes which modify the intensity of, 402 ; Melloni's researches on, 416 ; relation of gases and vapours to, 426  
 Radiated heat, 391, 399  
 Radiating power, 413 ; identity of absorbing and radiating, 414 ; causes which modify, &c., 415 ; of gases, 429  
 Radiation, cold produced by, 481 ; from powders, 431 ; of gases, luminous, and obscure, 420 ; laws of, 401 ; solar, 466  
 Radiative power, 935  
 Rain, 934 ; clouds, 934 ; bow, 953 ; fall, 926, 934 ; gauge, 934 ; drop, velocity of, 48  
 Ramsden's electrical machine, 730  
 Rarefaction in air-pump, 188 ; by Sprengel's pump, 193  
 Ray, incident, 522 ; luminous, 487 ; ordinary and extraordinary, 623  
 Rays, actinic, or Ritteric, 421 ; diver-

## R.F.A.

gent and convergent, 487; frigorific, 410; of heat, 399, 417; invisible, 417; obscure, 421; path of, in eye, 597; polarised, 644; transmutation of thermal, 422

Reaction and action, 39

Reaction machines, 458

Real volume, 14; foci, 538; focus, 511; image, 514, 542

Réaumur scale, 293

Receiver of air-pump, 188

Recomposition of white light, 552

Reed instruments, 265

Reeds, free and beating, 265

Reflected light, intensity of, 505

Reflecting power, 411; goniometer, 520; sextant, 507; stereoscope, 605; telescope, 580

Reflection, apparent, of cold, 410; of heat, 406; from concave mirrors, 407; irregular, 504; laws of, 405; verification of laws of, 408; in a vacuum, 409; of light, 497-527; of sound, 231

Refracting stereoscope, 606; telescope, 580

Refraction, 522-527; double, 621; polarisation by, 634; explanation of single, 620; of sound, 233

Refractive index, 524; of gases, 536; of liquids, 535; of solids, 534; table of, 536; indices of media of eye, 595

Refractory substances, 327

Refrangibility of light, alteration of, 564

Regelation, 941

Regnault's experiments, 225; determination of density of gases, 325; manometer, 179; methods of determining the expansion of gases, 322; of specific heat, 441; of tension of aqueous vapour, 345, 347; hygrometer, 385

Regulator of the electric light, 811, 812

Relay, 860

Remanent magnetism, 855

Repulsions, magnetic, 687; electrical laws of, 712

Reservoir, common, 707

Residual charge, 751

Residue, electric, 751

Resinous electricity, 708, 709

Resistance of a conductor, 801; of an element, 913

Resonance, 232; box, 246; globe, 250

Rest, 18

Resultant of forces, 32-34

Retina, 594; persistence of impression on, 607

## SCA

Return shock, 951

Reversion, method of, 678

Rheometer, 797

Rheoscope, 797

Rheoscopic frog, 920

Rheostat, 908

Rhomb, Fresnel's, 653

Rhumbs, 679, 927

Right ascension, 582

Rime, 928

Rings, coloured, 648; in biaxial crystals, 649; Newton's 632, 633; Nobili's, 825

Ritchie's experiment, 414

Ritteric rays, 421

Rock salt, heat transmitted through, 425

Rods, vibrations of, 274

Roget's vibrating spiral, 832

Rose's fusible metal, 329

Rotating mirror, 770

Rotation, electrodynamic and electromagnetic, of liquids, 842

Rotation of the earth, 81; of magnets, by currents, 839; of currents by magnets, 841; of induced currents by magnets, 892

Rotatory power of liquids, 658; polarisation, 655, 656; coloration produced by, 657

Rousseau's densimeter, 131

Roy and Ramsden's measurement of linear expansion, 306

Rubbers, 730

Rubidium, 561

Ruhlmann's barometer and thermometric observations, 172

Ruhmkorff's coil, 887; effects produced by, 889

Rumford's photometer, 495

Rutherford's thermometers, 301

**SACCHARIMETER, 659**

Saccharometer, 127

Safety-valve, 109, 360; tube, 368; whistle, 453

Sagitta of meniscus, 163

Salimeters, 130

Salts, decomposition of, 817

Saturation, degree of, 330; magnetic, 698; of colours, 555

Saussure's hygrometer, 387

Savart's toothed wheel, 236

Scale of hardness, 94

Scales in music, 243; chromatic, 245; of a thermometer, 293; conversion of, into one another, 293

- SCA
- Scattered heat, 412; light, 504  
 Schehallien experiment, 68  
 Sclerotica, 594  
 Scott's phonautograph, 280  
 Screw, 11, 45  
 Secondary axis, 541; batteries, 822; currents, 782; coil, 862  
 Second of time, 21, 25  
 Seconds pendulum, 80  
 Secular magnetic variations, 674  
 Segments, ventral and nodal, 212  
 Segner's water-wheel, 214  
 Selenite, 646  
 Semicircular deviation, 697  
 Semi-conductors, 706  
 Semi-tones, 244  
 Senarmont's experiment, 394  
 Sensitive membrane, 225  
 Sérein, 936  
 Series, thermo-electric, 897  
 Serum, 12  
 Sextant, 507  
 Shadow, 489  
 Shaft, 454  
 Shock, electric, 748-758; return, 951  
 Short sight, 611  
 Siemens' armature, 883; unit, 884; electrical thermometer, 916  
 Sight, line of, 577  
 Silver, voltameter, 820  
 Simoom, 929  
 Sine compass, 800  
 Singing of liquids, 352  
 Sinuous currents, 834  
 Sirocco, 929  
 Size, estimation of, 600  
 Sleet, 939  
 Slide valve, 454  
 Smee's battery, 787  
 Snow, 939; line, 942  
 Soap bubble, colours of, 632  
 Solar microscope, 587; light, thermal analysis of, 418; radiation, 466; spectrum, 549; properties of the, 557; dark lines of, 558, 562; time, 21; day, 21  
 Soleil's saccharimeter, 659  
 Solenoids, 847-851; action of currents on, 848; of magnets and of earth on, 849, 850; on solenoids, 851  
 Solidification, 332; change of volume on, 332, 335; retardation of, 334  
 Solidity, 4, 7  
 Solids, conductivity of, 392; index of refraction in, 534; diamagnetism of, 895; linear and cubical expansion of, 304, 309
- SPI
- Solids, formulæ of expansion, 308  
 Solution, 331  
 Sondhauss's experiments, 233  
 Sonometer, 259  
 Sonorous body, 218  
 Sound, 217; cause of, 218; not propagated in vacuo, 219; propagated in all elastic bodies, 220; propagation of, in air, 221; causes which influence intensity of, 222; apparatus to strengthen, 223; velocity of, in gases, 226-228; in liquids and solids, 230; reflection of, 231; refraction of, 233; transmission of, 224; waves, 225  
 Sound, Helmholtz's analysis of, 250  
 Sound, König's apparatus, 250; Kundt's, 270  
 Sounder, 864  
 Sounds, intensity of, 282; limit of perceptible, 239; synthesis of, 252; perceptions of, 254; produced by currents, 838  
 Space, measure of, 22  
 Spar, Iceland, 641  
 Spark and brush discharge, 762; electrical, 740, 762; duration and velocity of, 770  
 Speaking trumpet, 234; tubes, 224  
 Specific gravity, 24, 120, 125; bottle, 122; of solids, 121; of gases, 324; of liquids, 124; tables of, 125, 126  
 Specific heat, 435-448; compound bodies, 549; determination of, by fusion of ice, 437; by method of mixtures, 439; by Regnault's apparatus, 441; of solids and liquids, 443, 444; of gases, 447  
 Specific inductive capacity, 725  
 Spectacles, 612  
 Spectral analysis, 559  
 Spectroscope, 560; experiments with, 561; uses of the, 563  
 Spectrum, calorific, 557; chemical, 557  
 Spectrum, 418; colours of, 551; pure, 550; solar, 549, 561  
 Spectrum, dark lines of, 557  
 Spectrum, diffraction, 630  
 Spectrum, luminous properties, 557  
 Spectrum of aurora borealis, 954; properties of, 557  
 Specular reflection, 504  
 Spherical aberration, 519, 544; mirrors, 510; focus of, 511; formulæ for, 516  
 Spheroidal form of liquids, 85; state, 373  
 Spherometer, 11  
 Spiral, 854; Roget's vibrating, 832  
 Spirit-level, 111

## SPR

Sprengel's air-pump, 193  
 Stable equilibrium, 71  
 Stars, spectral analysis of, 564  
 Stauhbach, 77  
 Steam-engines, 452; boiler, 455; double action, or Watt's, 454; pipe, 194; various kinds of, 459; work of, 460; heating by, 476  
 Steeling, 830  
 Stereoscopes, 604-606  
 Stethoscope, 235  
 Stills, 365  
 Stool, insulating, 740  
 Stopcock, doubly exhausting, 190; Gay-Lussac's, 371  
 Storms, magnetic, 676  
 Stoves, 475; Norwegian, 398  
 Stratification of electric light, 890  
 Stratus, 932  
 Stringed instruments, 272  
 Strings, 258; transverse vibration of, 258  
 Subdominant chords, 243  
 Suction pump, 203; and force pump, 204; load which piston supports, 205  
 Sulphate of mercury battery, 788  
 Sun, analysis of, 562; constitution of, 562  
 Sun spots, 683  
 Surface level, 68; tension, 138  
 Suspension, axis of, 72; Cardan's, 160  
 Suspensory ligament, 594  
 Swimming, 119; bladder of fishes, 118  
 Symmer's theory of electricity, 709  
 Synthesis of sounds, 252  
 Syphon, 200; intermittent, 201  
 Syphon barometer, 161  
 Syren, 237  
 Syringe, pneumatic, 148, 464

**T**AMTAM metal, 95  
 Tangent compass, or galvanometer, 799, 821  
 Telegraph, cables, induction in, 861; electric, 857; dial, 859; Morse's, 860  
 Telephone, 856  
 Telescopes, 577-583; astronomical, 577; Galilean, 579; Gregorian, 581; Herschelian, 583; Newtonian, 581; reflecting, Rosse's, 583  
 Telluric lines, 557  
 Temper, 95  
 Temperature, 287, 435; correction for, in barometer, 164; critical, 359; of a body, 287; determined by specific heat, 444

## THO

Temperature, absolute zero of, 482; influence of, on specific gravity, 124; mean, 955; how modified, 956; distribution of, 960; of lakes, springs, 961  
 Temperatures, different remarkable, 302; influence on expansion, 308  
 Tempering, 91, 95  
 Tenacity, 7, 92  
 Tension, 118, 716, 888; maximum of electrical machine, 732; maximum of vapours, 342; of aqueous vapour at various temperatures, 346-350; of vapours of different liquids, 348; of mixed liquids in two communicating vessels, 350; free surface, 138  
 Terquem's experiment, 715  
 Terrestrial currents, 853; heat, 467; magnetic couple, 672; telescope, 578  
 Terrestrial gravitation, 68, 83  
 Terrestrial magnetic couple, 672  
 Tetanus, 803  
 Thallium, 561  
 Thaumatrope, 607  
 Theodolite, 10  
 Theory, 5; of induction, 724  
 Thermal analysis, 418; unit, 434, 470; springs, 961  
 Thermal effects of the current, 805, 806  
 Thermal rays, transmutation of, 422; unit, 434  
 Thermo-barometer, 358  
 Thermocrose, 424  
 Thermo-electric battery, 400, 901; couples, 899; currents, 898, 900, 904; pile, 400, 419, 900; series, 897  
 Thermo-electricity, 896  
 Thermo-element, 897  
 Thermometer, electric, 767  
 Thermometers, 288; Becquerel's electrical, 905; division of tubes in, 289; filling, 290; graduation of, 291; determination of fixed points of, 292; scale of, 293; displacement of zero, 294; limits to use of, 295; alcohol, 296; conditions of delicacy of, 297; Kinnersley's, 769; Leslie's, 298; Matthiessen's, 298; Breguet's, 299; maximum and minimum, 290; Siemens' electrical, 916; weight, 314; air, 320, 321  
 Thermometry, 287-300  
 Thermo-multiplier, Melloni's, 903  
 Thermoscope, 298  
 Thomson's electrometer, 758; galvanometer, 798; apparatus for atmospheric electricity, 944



## THR

Thread of a screw, 45  
 Thunder, 947  
 Timbre, 241  
 Time, measure of, 21; mean solar, 21  
 Tint, 555; transition, 659  
 Tones, combinational, 256; differential, 256  
 Tonic, 243  
 Torricelli's experiment, 155; theorem, 207; vacuum, 162  
 Torsion, angle of, 90; balance, 90, 686, 714; force of, 90  
 Total reflection, 526  
 Tourmaline, 640, 713; pincette, 648  
 Tourniquet, hydraulic, 213  
 Traction, elasticity of, 89  
 Trajectory, 25  
 Transformation of energy, 65  
 Transition tint, 659  
 Transparency, 7, 486  
 Transparent media, 528-535  
 Transpiration of gases, 143  
 Translucent bodies, 486  
 Transmission of heat, 391; of light, 485, 528; by the current, 818  
 Transmission of sound, 224  
 Triad, harmonic, 242  
 Triangle, 274  
 Triangle of forces, 35  
 Trumpet, speaking, ear, 234  
 Tubes, Geissler's, 193, 891; luminous, 764; safety, 368; speaking, 224  
 Tuning-fork, 246, 274, 283  
 Turbines, 214  
 Tyndall's researches, 419, 937

**UNANNEALED** glass, colours produced by, 650  
 Undershot wheels, 214  
 Undulation, length of, 221, 619  
 Undulatory theory, 485  
 Uniaxial crystals, 622; double refraction in, 624; positive and negative, 625  
 Unit jar, Harris's, 756; Siemens', 909; thermal, 434  
 Unit of length, area and volume, 22; heat, 434; of work, 62  
 Unstable equilibrium, 71  
 Urinometer, 130

**VACUO**, loss of electricity in, 720  
 Vacuum, application of, to construction of air-pump, 188; extent of, produced by air-pump, 189; fall of bodies in a, 77; formation of vapour

## VIT

in, 341; heat radiated in, 401; reflection in a, 409; Torricellian, 162  
 Valve, safety, 109, 360; chest, 453  
 Vane, electrical, 742  
 Vaporisation, 339; latent heat of, 361, 449  
 Vapour, aqueous, tension of, at various temperatures, 346-350; formation of, in closed tube, 359; latent heat of, 361  
 Vapours, 338; absorption of heat by, 423; absorptive powers of, 428; density of, Gay-Lussac's method, 374; Hofmann's, 375; determination of latent heat of, 448; Dumas's method, 376; elastic force of, 340; formation of, in vacuo, 341; saturated, 342; unsaturated, 343; tension of different liquids, 348; of mixed liquids, 349; in communicating vessels, 350  
 Variations, annual, 675; accidental, 676; barometric, 165; causes of, 166; diurnal, 675; relation of, to weather, 166; in magnetic declination, 673, 677  
 Varley unit, 909  
 Velocity, 25; direction of, 56; of efflux, 207; of electricity, 770; of light, 491-493; graphic representation of changes of, 56; of sound in gases, 226, 227; formula for calculating, 227; of winds, 927  
 Velocities, composition of, 52; examples of, 25  
 Vena contracta, 210  
 Ventral and nodal segment, 212, 262, 267  
 Vernier, 10  
 Vertical line, 68  
 Vibrating spiral, Roget's, 832  
 Vibration, 218; arc of, 55; produced by currents, 856; of tuning-forks, 283  
 Vibrations, 255; formulæ, 268; of membranes, 276; laws of, 260; measurement of number of, 236; number of, producing each note, 246; of musical pipe, 268; of rods, 274; of plates, 275; of strings, 258, 260, 261  
 View, field of, 575  
 Vinometers, 130  
 Virtual and real images, 500; focus, 511; velocity, 46  
 Vision, distance of distinct, 601; binocular, 603  
 Visual angle, 599  
 Vis viva, 60, 435, 483  
 Vital fluid, 772  
 Vitreous body, 594; electricity, 708; fusion, 327; humour, 594

## VOC

Vocal chords, 254  
 Volatile liquids, 338  
 Volta's condensing electroscope, 757 ;  
 electrophorus, 729 ; fundamental ex-  
 periment, 773  
 Voltaic arc, 809 ; couple, 777 ; currents,  
 795 ; induction, 868 ; pile and battery,  
 780, 781, 791, 808  
 Voltmeter, silver, 820 ; Faraday's, 820  
 Volume, 22 ; unit of, 22, 24 ; determi-  
 nation of, 115 ; change of, on solidi-  
 fication, 335 ; of a liquid and that of  
 its vapour, relation between, 378  
 Von Ebner's electrical machine, 769

**W**ALKER'S battery, 787  
 Water bellows, 194 ; decompo-  
 sition of, 124 ; hammer, 77 ; hot, heat-  
 ing by, 478 ; level, 110  
 Water, maximum density of, 319 ; spouts,  
 935 ; wheels, 214  
 Watt's engine, 454  
 Wave, condensed, 221 ; expanded, 221 ;  
 lengths, 619, 631 ; plane, 624  
 Weather, its influence on barometric va-  
 riations, 165, 166 ; glasses, 168  
 Wedge, 44  
 Wedgewood's pyrometer, 301  
 Weighing, method of double, 76  
 Weight, 23, 83 ; of bodies weighed in  
 air, correction for loss of, 390 ; of  
 gases, 150 ; thermometer, 314  
 Weights and measures, 126  
 Wells, artesian, 112  
 Wells's theory of dew, 928  
 Wet-bulb hygrometer, 386  
 Wheatstone's bridge, 912 ; photometer,  
 495 ; rheostat, 908 ; rotating mirror,  
 770 ; and Cooke's telegraph, 858  
 Wheel and axle, 42  
 Wheel barometer, 168

## ZON

Wheels, friction, 78 ; escapement, 82 ;  
 water, 214  
 Whirl, electrical, 742  
 Whispering galleries, 232  
 Whistle, safety, 453  
 White light, decomposition of, 549 ; re-  
 composition of, 552  
 White's pulley, 41  
 Wiedemann and Franz's tables of con-  
 ductivity, 392  
 Wild's magneto-electrical machine, 884  
 Winckler's cushions, 730  
 Windchest, 265 ; instruments, 263, 273  
 Winds, causes of, 928 ; direction and  
 velocity of, 926, 956 ; law of rotation  
 of, 930 ; periodical, regular, and vari-  
 able, 929  
 Wines, alcoholic value of, 367  
 Wollaston's battery, 781 ; cryophorus,  
 362 ; doublet, 567  
 Wood, conductivity of, 392  
 Wood's fusible metal, 329  
 Work, 34, 60 ; measure of, 61 ; of an  
 engine, 459 ; rate of, 459 ; unit of, 62 ;  
 internal and external, of bodies, 285 ;  
 of a voltaic battery, 808 ; required for  
 the production of electricity, 739

**Y**ARD, British, 22, 126  
 Young and Fresnel's experiment,  
 627

**Z**AMBONI'S pile, 793  
 Zero, absolute, 482 ; aqueous va-  
 pours below, 344 ; displacement of,  
 294  
 Zinc, amalgamated, 792 ; carbon battery,  
 786  
 Zone, isothermal, 958

